

GRABER | DELIGHT IN EVERY DETAIL



Graber Cornices

English/US Price Guide

CORNICES, VALANCES, AND PALLADIAN WINDOW SHELF

Product Information Guide

Features

Wood Characteristics	2
Wood Cornices	3
Wood Valances	3
Composite and Faux Wood Valances	3
Palladian Window Shelf	3

Size Considerations

Cornices and Valances	4
Palladian Window Shelf	4

Options

Wood Cornices	5
Wood Valances	6
Composite and Faux Wood Valances	7
Decorative Keystones	8
Splicing Requirements	8
Palladian Window Shelf	9

General Information

Valance Returns: Horizontal Blinds	10-11
Wood Valance Returns	12-14
Wood Cornice Returns	15-16
Composite and Faux Wood Valance Returns	17-18
How to Measure for Valance Returns	19
How to Measure and Order Cornices and Valances	20
How to Measure a Special Splice Location	21
Custom Color	21
Mounting Brackets	22

GRABER®

AUGUST 2023

Features

Cornices and valances easily lend an impressive touch to windows and doors. Used on their own or over window treatments, cornices and valances are as decorative as they are functional.

Palladian window shelves create a mounting surface for unique or difficult installations.

- Unique styles of wood cornices, wood valances, and faux wood valances provide the perfect solution for any décor
- Wood cornices and valances are crafted from premium North American hardwood and are available in all paints and stains to coordinate with Graber® Wood Blinds, as well as unfinished
- Dress up a drab window
- Enlarge a window
- Keystones are included with a spliced cornice or wood valance
- Additional keystones are available as a surcharge option for cornices or wood valances that do not require splices

Wood Characteristics

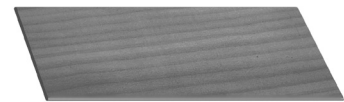

Flat Grain

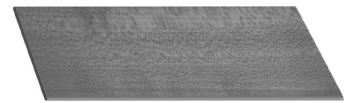

Grain Change



Tiger Striping

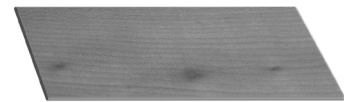

Burl/Bird's Eye

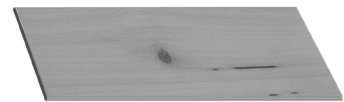

Pin Knots

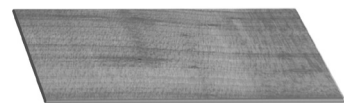

Mineral Marks

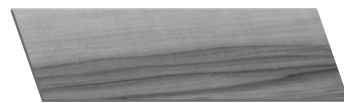

Knotty Pine/
Rustic

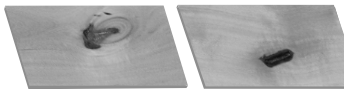

Knotty Pine/
Rustic

Wood used to manufacture Graber Wood Blinds has many natural characteristics which make it truly unique...no two pieces of hardwood are alike. The following are all natural characteristics of wood and we do not consider them to be defects:

- Grain—The direction, size, and appearance of wood fibers vary greatly depending on where the wood is cut from within the tree
- Tiger Striping—Occurs when a tree develops wavy grain, due to genetics, soil content, or other natural scenarios
- Burl Grain—Formed from an irregular growth on the outer edge of the tree
- Bird's Eye—Small area on the surface of the board where fibers are contorted to form circular figures that resemble birds' eyes
- Pin Knots—Vary in size, shape, structure, and color
- Mineral Marks—Dark or discolored area caused by minerals which the tree extracts from the water or soil; can be either a streak or a stain, usually blackish blue
- Knotty Pine/Rustic—Material contains markings that are more extreme than in standard products; the number and degree of marking will vary throughout the blind

Please be assured that these markings in no way affect the durability or the structural integrity of the blind.

Natural variations in color and grain effect are inherent in the beauty of wood. These variations are within established industry guidelines and should be expected. When two or more pieces of wood are spliced together to create wider valances or cornices, there may be variations in the dye lot and grain between the sections. In addition, valances and cornices may stain slightly darker or lighter than the samples shown in the sample books and selectors.

Features

Wood Cornices

- Crafted from premium North American hardwood
- Fine furniture-quality finish
- L-brackets are included for easy installation
- Cornices are available in all paints and stains to coordinate with Graber® Traditions® Wood Blinds, as well as unfinished or custom color
- Keystones are included with spliced cornices and are available as a surcharge option for cornices that do not require a splice

Wood Valances

- Crafted from premium North American hardwood
- Fine furniture-quality finish
- Includes mounting hardware for specified product use
- Valances are available in all paints and stains to coordinate with Graber Wood Blinds, as well as unfinished or custom color
- Keystones are included with spliced valances and are available as a surcharge option for valances that do not require a splice

Composite and Faux Wood Valances

- Composite and faux wood options are ideal for a finishing look in a high humidity room
- Includes mounting hardware for specified product use

Palladian Window Shelf

- Crafted from premium North American hardwood
- Fine furniture-quality finish
- Available in all paints and stains to coordinate with Graber Wood Blinds, as well as unfinished or custom color
- Create a mounting surface for unique or difficult installations
- Available in depths from 4" to as narrow as 2"
- Mounting hardware included

Size Considerations

Cornices and Valances

Type of Valance or Cornice	Minimum Width		Maximum Width without Splicing		Maximum Width with Splicing	
	Inside Mount (inches)	Outside Mount (inches)	Inside Mount No Returns (inches)	Outside Mount or Inside Mount with Returns (inches)	Inside Mount (inches)	Outside Mount (inches)
2½" Classic Barnwood Valance†	8¼	8	100¼	98¾	300¾	298¾
3" Classic Wood Valance	8¼	8	100¼	98¾	300¾	298¾
3½" Craftsman Wood Valance	8¼	8	100¼	98¾	300¾	298¾
3½" Legacy Wood Valance	8¼	8	100¼	98¾	300¾	298¾
4½" Symphony Wood Valance/Cornice^	8¼	8	100¼	98¾	300¾	298¾
3" Classic Composite or Faux Wood Valance†	8¼	8	106¾	105¾	300	298¾
3" Majestic Composite or Faux Wood Valance†	8¼	8	106¾	105¾	300	298¾
5½" Noble Wood Cornice^	8¼	8	94	92½	366	366
7½" Noble Wood Cornice^	8¼	8	94	91¾	366	366
5½" Regal Wood Cornice^	8¼	8	94	91½	366	366
7½" Regal Wood Cornice^	8¼	8	94	90	366	366

^Inside mount wood cornices that require a keystone cannot be mounted flush to the top of the window casing. There will be approximately a ¼" gap at the top and the installation brackets may be visible with this application.

†Keystones not available on authentic hardwood, barnwood, distressed wood, in sandblast finish, composite, or faux wood valances.

NOTE: Cornices and valances wider than the widths shown in the chart above will be manufactured in multiple sections. The sections must be assembled during installation. Customer may request specific locations for the splices as long as it does not exceed our maximum single piece size. All requests for additional cornice or wood valance splices require a keystone. The keystone surcharge applies to each additional splice.

These formulas are used to calculate BACKSIDE valance measurements by product type.

All Except: • Natural Drapes • Sheer Verticals • Artisan Fabric Roman Shades • Other Applications	Inside mount	No returns	OW -¼"
		With returns	
Natural Drapes	Outside mount	No returns	OW +½"
		With returns	OW +¾"
	Inside mount	No returns	OW -¼"
		With returns	OW +½"
Sheer Verticals	Outside mount	No returns	OW +½"
		With returns	OW +1"
	Inside mount	No returns	OW -¼"
		With returns	Ordered width
Artisan Fabric Roman Shades	Outside mount	No returns	OW +¼"
		With returns	OW +¾"
	Inside mount	No returns	OW +3½"
		With returns	OW +4"
Other Applications	Outside mount	No returns	Ordered width
		With returns	Ordered width
	Inside mount	No returns	Ordered width
		With returns	Ordered width

These formulas are used to calculate BACKSIDE cornice measurements by product type.

All Except: • Natural Drapes • Sheer Verticals • Artisan Fabric Roman Shades • Other Applications	Inside mount	No returns	OW -¼"
		With returns	
Natural Drapes	Outside mount	No returns	OW -¼"
		With returns	OW +1"
	Inside mount	No returns	OW -¼"
		With returns	OW +½"
Artisan Fabric Roman Shades	Outside mount	No returns	OW -¼"
		With returns	OW +2"
	Inside mount	No returns	OW -¼"
		With returns	Ordered width
Other Applications	No returns	Ordered width	
	With returns	Ordered width	

If the product option of other is selected during entry, the backside cornice/valance measurement will be the exact width entered. There will be no additions or deductions taken. Cornice or valance return size must be specified. Soft drapery falls within the 'other applications' category.

Palladian Window Shelf

	Minimum Width Inside Mount Only (inches)	Maximum Width Inside Mount Only (inches)	Minimum Depth (inches)	Maximum Depth (inches)
Palladian Window Shelf	7	96	2	4

NOTE: Inside mount application only. The finished shelf will be ordered width less ¼". The shelf is designed for end mounting; no center supports are available. End mounting brackets must be mounted to a flat vertical surface. If installation is inside an arch, the top of the palladian shelf must be mounted at or below the start of the arch curve. Shelf can be installed in a vertical application to divide a large window. Depending on the width of the window opening and the weight of the blind or shade, deflection up to ½" may occur.

Options

Wood Cornices

- Crafted from premium North American hardwood
- Fine furniture-quality finish
- Installation hardware is included for easy installation
- Cornices available in all paints and stains to coordinate with Graber® Traditions® Wood Blinds, as well as unfinished or with custom color
- Inside mount has straight cut ends, no returns, no dust cover
- Outside mount has mitered corners, returns, and a dust cover* to conceal the top of the blind
- Custom returns may be ordered for outside mount up to 8"; minimum return is ½"
- Cornices not available on bay or corner windows
- Single side return available; opposite end will be straight cut

*Dust cover is unfinished and will not match selected color.

NOTE: Wood cornice will be shipped separate from blinds. Manufacturer recommends installing blind and cornice at the same time.

Regal Wood—Outside Mount

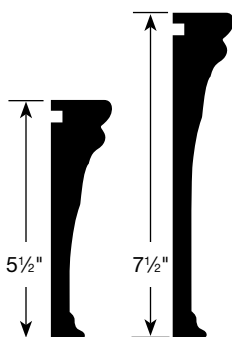
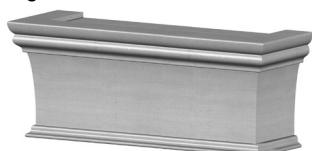

Regal Wood—Inside Mount

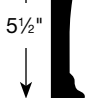

Noble Wood—Outside Mount

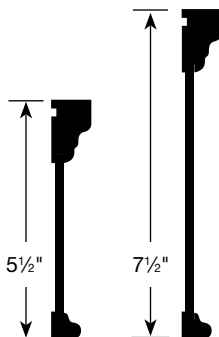
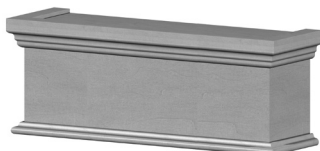

Noble Wood—Inside Mount

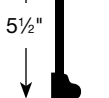
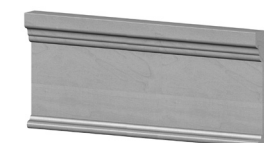

Regal Wood Cornice

Available in either a 5½" or 7½" size and in all colors listed below.

Noble Wood Cornice

Available in either a 5½" or 7½" size and in all colors listed below.

Paint Colors

Angora	1052
Antique White	1026
Base White	1051
Crisp White	1712
Custom Color*	CUSP
Dover White	1683
Dovetail	1839
Grey Beige	1817
Medium Grey	1841
Pearl	1840
Snow White	1850
Snowflake	1603
Stepping Stone	1889
Stucco	1963

Stain Colors

Allspice	1821	Honey Maple	1013
Cappuccino	1546	Natural	1007
Cherry Wood	1014	Roasted Chestnut	1849
Cognac	1465	Saddle Brown	1694
Custom Color*	CUSS	Sienna	1685
Dark Cherry	1316	Timeless Grey	1847
Dark Walnut	1641	True Taupe	1848
Espresso	1716	Truffle	1054
Golden Oak	1030	Unfinished	1717
Harbor Grey	1761	Walnut	1012
Henna	1949	Wheat	1710
Homestead Oak	1943		

Symphony Wood—Outside Mount

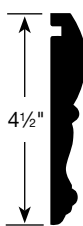

Symphony Wood—Inside Mount

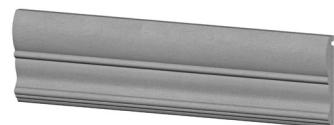

Symphony Wood Cornice

Available in 4½" size and in all colors listed below.

Paint Colors

Angora	1052
Antique White	1026
Base White	1051
Crisp White	1712
Custom Color*	CUSP
Dover White	1683
Dovetail	1839
Grey Beige	1817
Medium Grey	1841
Medium Grey Sandblast†	SB841
Pearl	1840
Snow White	1850
Snowflake	1603
Snowflake Sandblast†	SB603
Stepping Stone	1889
Stucco	1963

Stain Colors

Allspice	1821	Honey Maple	1013
Cappuccino	1546	Knotty Pine	1515
Cherry Wood	1014	Natural	1007
Cognac	1465	Roasted Chestnut	1849
Custom Color*	CUSS	Saddle Brown	1694
Dark Cherry	1316	Sienna	1685
Dark Walnut	1641	Timeless Grey	1847
Espresso	1716	True Taupe	1848
Golden Oak	1030	Truffle	1054
Harbor Grey	1761	Unfinished	1717
Henna	1949	Walnut	1012
Homestead Oak	1943	Wheat	1710

*Custom color: see price charts for net surcharge per color.

†Keystones are not available in sandblast finish, but will come in matching paint color in a smooth finish.

Options

Wood Valances

- Painted and stained valances crafted from premium North American hardwood
- Fine furniture-quality finish
- Returns for inside mount must be specified
- Inside mount has straight cut ends, no returns
- Outside mount has mitered corners and returns
- Custom returns may be ordered for both inside and outside mount up to 8"; minimum return is 1/2"
- Valances only available on bay and corner windows if bay and corner application is available on entire product line selected
- Single side return available; opposite end will be straight cut

NOTE: Wood valance will be shipped separate from blinds. Manufacturer recommends installing blind and valance at the same time.

Classic—Outside Mount



Classic—Inside Mount



Classic Valance

3" available in all colors at bottom of page.
2 1/2" available in barnwood; not available with keystones.

Barnwood Colors

Medium Pewter . . . 1049
Windswept. 1072

Legacy—Outside Mount

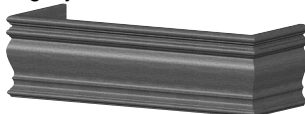

Legacy—Inside Mount

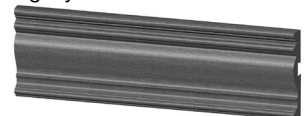

3 1/2" Legacy Valance

Available in all colors at bottom of page.
Available in distressed wood and authentic hardwood; not available with keystones.

Distressed Wood Colors

Smoky Coal 1572
Twig 1070

Authentic Hardwood Colors

Cherry C007
Maple M007
Walnut W007

Craftsman—Outside Mount

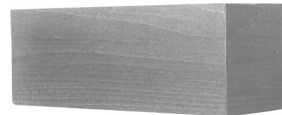

Craftsman—Inside Mount



3 1/2" Craftsman Valance

Available in all colors at bottom of page.

Symphony—Outside Mount

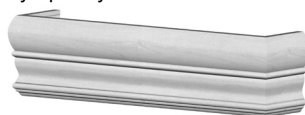

Symphony—Inside Mount

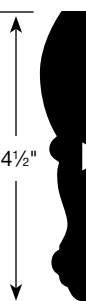
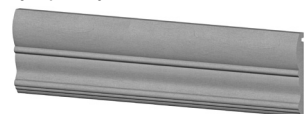

4 1/2" Symphony Wood Valance

Available in all colors at bottom of page.

Paint Colors

Angora 1052	Medium Grey 1841
Antique White 1026	Medium Grey Sandblast† .SB841
Base White 1051	Pearl 1840
Crisp White 1712	Snow White 1850
Custom Color* CUSP	Snowflake 1603
Dover White 1683	Snowflake Sandblast† . SB603
Dovetail 1839	Stepping Stone 1889
Grey Beige 1817	Stucco 1963

Stain Colors

Allspice 1821	Natural 1007
Cappuccino 1546	Roasted Chestnut 1849
Cherry Wood 1014	Rustic Cognac R1465
Cognac 1465	Rustic Golden Oak . . . R1030
Custom Color* CUSS	Rustic Harbor Grey . . . R1761
Dark Cherry 1316	Saddle Brown 1694
Dark Walnut 1641	Sienna 1685
Espresso 1716	Timeless Grey 1847
Golden Oak 1030	True Taupe 1848
Harbor Grey 1761	Truffle 1054
Henna 1949	Unfinished 1717
Homestead Oak 1943	Walnut 1012
Honey Maple 1013	Wheat 1710
Knotty Pine 1515	

*Custom color: see price charts for net surcharge per color.

†Keystones are not available in sandblast finish, but will come in matching paint color in a smooth finish.

Options

Composite and Faux Wood Valances

- Composite and faux wood valance options are ideal for a finished look in a high humidity room
- Includes mounting hardware for specified product use
- Returns for inside mount must be specified
- Inside mount has straight cut ends, no returns
- Outside mount has mitered corners and returns
- Custom returns may be ordered for both inside and outside mount up to 8"; minimum return is ½"
- Valances only available on bay and corner windows if bay and corner application is available on entire product line selected
- Single side return available; opposite end will be straight cut
- Not available with keystones

NOTE: Composite and faux wood valances will be shipped separate from blinds. Manufacturer recommends installing blind and valance at the same time.

Classic—Outside Mount



Classic—Inside Mount

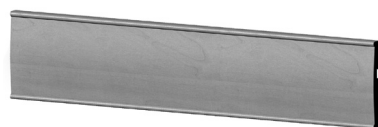

3" Classic Composite and Faux Wood Valance

Add a classic touch to any room.

Available in all colors listed at the bottom of page.

Majestic—Outside Mount



Majestic—Inside Mount



3" Majestic Composite and Faux Wood Valance

Add a decorative element to the window.

Available in all colors listed at the bottom of page.

Composite Colors

Antique White	2026
Base White	2051
Creamy White	2729
Seattle Grey	2174
Silk White	2922

Premium Faux Wood Colors

Cognac	2465
Dark Cherry	2316
Golden Oak	2030
Honey Maple	2013
Misty Grey	2230
Moonshine	2738
Morel	2706
Natural	2007
Phantom	2707
Saddle Brown	2694
Sienna	2685
Walnut	2012
Wheat	2710

Faux Wood Colors

Almond	5724
Buttermilk	5078
Buttermilk Textured†	5953
Coconut	5630
Coconut Textured†	5299
Marshmallow	5742
Milky Way	5058
Milky Way Textured†	5304
Seattle Grey	5174
White	5035
White Textured†	5951

†Classic valance will be textured. Majestic valance will be color coordinated in a smooth finish.

Options

Decorative Keystones

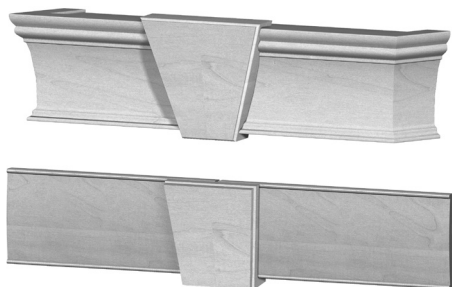

- Decorative keystones are required on wood cornices and valances that require splicing
- The keystones will be equally spaced unless special splice locations are requested at time of order
- Keystones can be requested on wood cornices without a splice at time of order
 - Minimum width with a keystone: 12"
 - Maximum number of keystones: 3
- Keystones will be stained or painted to match the valance or cornice ordered as standard; optional different color selection available
- Keystones not available on authentic hardwood, barnwood, distressed wood, in sandblast finish, composite, or faux wood valances
- All inside mount applications will have a slight light gap at the top of the cornice or valance when installed with a keystone
- Keystones cannot be added to existing valances or symphony cornices because the keystones require splicing at the time of order

Splicing Requirements

Profile	Number of Sections	Number of Keystones	No Returns		With Returns (inside dimensions)	
			Minimum (inches)	Maximum (inches)	Minimum (inches)	Maximum (inches)
2½" Classic Barnwood Valance*	1	0	8	100¼	8	98¾
3" Classic Wood Valance	2	1	100⅞	200½	98⅞	198¾
3½" Craftsman Wood Valance	3	2	200⅞	300¾	198⅞	298¾
3½" Legacy Wood Valance	1	0	8	95	8	95
4½" Symphony Wood Valance	2	1	95⅞	190¾	95⅞	190¾
4½" Symphony Cornice	3	2	190⅞	285¾	190⅞	285¾
	4	3	285⅞	300	285⅞	300
	1	0	8	94	8	92½
5½" Noble Cornice	2	1	94⅞	187⅞	92⅞	185¾
	3	2	187⅞	280¾	185¾	278¼
	4	3	280⅞	366	278⅞	366
	1	0	8	94	8	91¾
7½" Noble Cornice	2	1	94⅞	186⅞	91⅞	184¾
	3	2	186¾	279¾	184¾	276¾
	4	3	279⅞	366	276⅞	366
	1	0	8	94	8	91¾
5½" Regal Cornice	2	1	94⅞	186⅞	91⅞	183⅞
	3	2	186¾	279¾	183¾	276¼
	4	3	279⅞	366	276⅞	366
	1	0	8	94	8	90
7½" Regal Cornice	2	1	94⅞	186	90⅞	182
	3	2	186⅞	278	182⅞	274
	4	3	278⅞	366	274⅞	366

*Keystones not available.

Outside Mount

- Wood cornices and valances requiring a splice will include a keystone (see chart above for details)

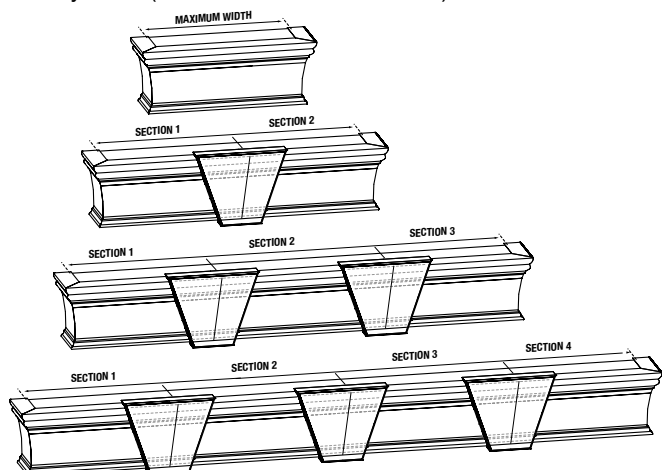

Inside Mount

- Wood valances 100¼" or wider and cornices 94" or wider will require a keystone

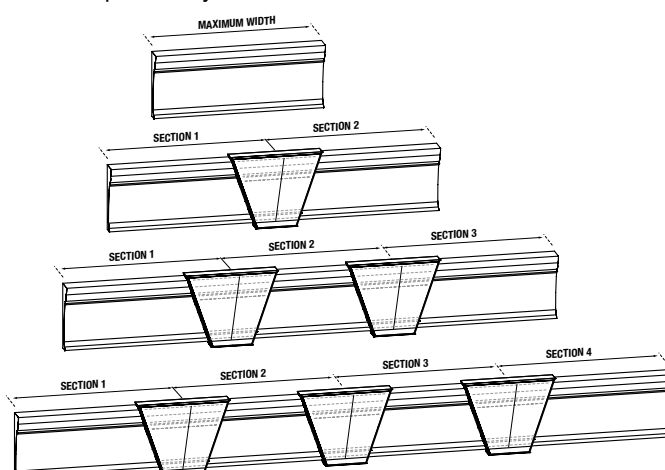

Options

Palladian Window Shelf

A wood shelf or header that may be installed in applications lacking a window frame for mounting a blind. Blinds or other window treatments may be installed either above or below the shelf.

- Created from premium North American hardwood
- Use with any Graber® blind or shade
- Ideal for arch top windows
- Use as a divider for long windows
- Easy mounting brackets included
- Available in all paints and stains to coordinate with Graber Wood Blinds, as well as unfinished or with custom color
- Available in depths from 4" to as narrow as 2"

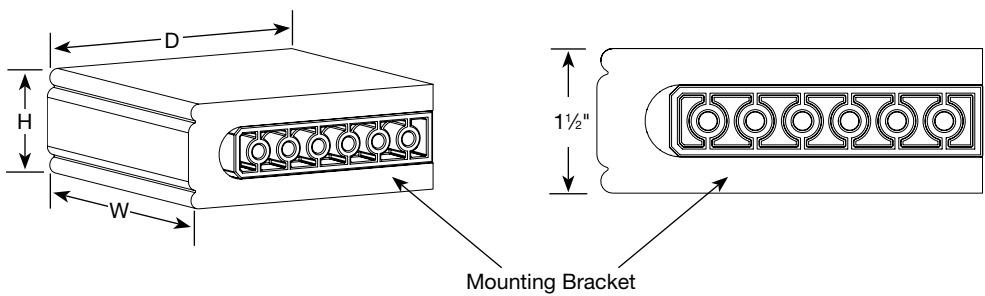

Paint Colors		Stain Colors	
Angora 1052	Grey Beige 1817	Allspice 1821	Honey Maple 1013
Antique White 1026	Medium Grey 1841	Cappuccino 1546	Natural 1007
Base White 1051	Pearl 1840	Cherry Wood 1014	Roasted Chestnut 1849
Crisp White 1712	Snow White 1850	Cognac 1465	Saddle Brown 1694
Custom Color* CUSP	Snowflake 1603	Custom Color* CUSS	Sienna 1685
Dover White 1683	Stepping Stone 1889	Dark Cherry 1316	Timeless Grey 1847
Dovetail 1839	Stucco 1963	Dark Walnut 1641	True Taupe 1848
		Espresso 1716	Truffle 1054
		Golden Oak 1030	Unfinished 1717
		Harbor Grey 1761	Walnut 1012
		Henna 1949	Wheat 1710
		Homestead Oak 1943	

*Custom color: see price charts for net surcharge per color.

General Information

Valance Returns: Horizontal Blinds

Returns for inside mount must be specified.

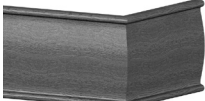
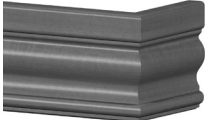
Valance Type	Blind Type	Maximum Continuous Width*		Control Type	Standard Valance Returns (inches)	Full Recess Depth (inches)
		Inside Mount No Returns (inches)	Inside Mount with Returns (inches)			
2½" Classic Valance  Valance Returns ½" to 1": glued 1¼" to 4⅝": optional glued 4⅞" and greater: not glued	2" Barnwood [^]	100¼	98¾	Wand tilt	3¼	3¾
				Cordless wand tilt	3¾	3¾
3" Classic Valance  Valance Returns ½" to 1": glued 1¼" to 4⅝": optional glued 4⅞" and greater: not glued	2" Wood 2" Elite Wood 2" Aluminum 2" Vinyl	100¼	98¾	Cordless wand tilt	3¾	3¾
	2⅝" Wood 2⅝" Elite Wood	100¼	98¾	Wand tilt	3¾	4¼
				Cordless wand tilt	3¾	3¾
	Wood Verticals	100¼	98¾	N/A	5½	5⅞
	2" Composite [^]	106¾	105¾	Wand tilt	3¾	3¾
				Cordless wand tilt	3¾	3¾
	2½" Composite [^]	106¾	105¾	Wand tilt	3⅞	4¼
				Cordless wand tilt	3¾	4¾
3" Majestic Valance  Valance Returns ½" to 1": glued 1¼" to 4⅝": optional glued 4⅞" and greater: not glued	2" Premium Faux Wood [^] 2" Faux Wood [^]	106¾	105¾	Wand tilt	3¾	3¾
				Cordless wand tilt	3¾	3¾
	2" Composite [^]	106¾	105¾	Wand tilt	3⅞	4¼
				Cordless wand tilt	3¾	4¼
	2" Premium Faux Wood [^] 2" Faux Wood [^]	106¾	105¾	Wand tilt	3¾	4¼
				Cordless wand tilt	3¾	3¾
	2½" Premium Faux Wood [^] 2½" Faux Wood [^]	106¾	105¾	Wand tilt	3⅞	4¼
				Cordless wand tilt	3¾	4¼



*Continuous valances wider than sizes shown above will have two or more sections spliced together with a keystone. Maximum width for spliced valances is 300¾".

[^]Keystones not available.

General Information

Valance Returns: Horizontal Blinds

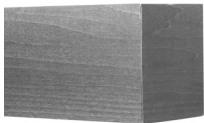
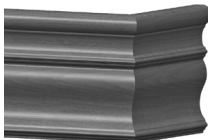
Returns for inside mount must be specified.

Valance Type	Blind Type	Maximum Continuous Width*		Control Type	Standard Valance Returns (inches)	Full Recess Depth (inches)
		Inside Mount No Returns (inches)	Inside Mount with Returns (inches)			
3½" Craftsman Valance  Valance Returns ½" to 1": glued 1⅛" to 4⅝": optional glued 4⅞" and greater: not glued	2" Wood 2" Elite Wood 2" Aluminum 2" Vinyl	100¼	98%	Wand tilt Cordless wand tilt	3⅞ 3⅞	3⅞ 3¾
	2⅜" Wood 2⅝" Elite Wood	100¼	98%	Wand tilt Cordless wand tilt	3¾ 3⅞	4⅞ 3⅞
	Wood Verticals	100¼	98%	N/A	5½	5⅞
3½" Legacy Valance  Valance Returns ½" to 1": glued 1⅛" to 4⅝": optional glued 4⅞" and greater: not glued	2" Wood 2" Elite Wood 2" Aluminum 2" Vinyl	100¼	98%	Wand tilt Cordless wand tilt	3⅞ 3⅞	4 3⅞
	2" Distressed Wood [^] 2" Elite Authentic Hardwood [^]	100¼	98%	Wand tilt Cordless wand tilt	3⅞ 3⅞	4 3⅞
	2⅜" Wood 2⅝" Elite Wood	100¼	98%	Wand tilt Cordless wand tilt	3¾ 3⅞	4⅞ 4⅞
	Wood Verticals	100¼	98%	N/A	5½	5⅞
4½" Symphony Valance  Valance Returns ½" to 1": glued 1⅛" to 4⅝": optional glued 4⅞" and greater: not glued	2" Wood 2" Elite Wood 2" Aluminum 2" Vinyl	100¼	98%	Wand tilt Cordless wand tilt	3⅞ 3⅞	4⅞ 4⅞
	2⅜" Wood 2⅝" Elite Wood	100¼	98%	Wand tilt Cordless wand tilt	3¾ 3⅞	4½ 4⅞
	Wood Verticals	100¼	98%	N/A	5½	6¼

*Continuous valances wider than sizes shown above will have two or more sections spliced together with a keystone. Maximum width for spliced valances is 300¼".

[^]Keystones not available.

General Information

Wood Valance Returns

Valance Type	Control Type	Standard Return Inside Width (inches)	Full Recess Depth (inches)
2" Wood, Aluminum, and Vinyl Horizontal Blinds			
2½" Classic Barnwood Valance†	Wand tilt	3⅞	3⅞
	Cordless wand tilt	3⅞	3¾
3" Classic Wood Valance	Wand tilt	3⅞	3⅞
	Cordless wand tilt	3⅞	3¾
3½" Craftsman Wood Valance	Wand tilt	3⅞	3⅞
	Cordless wand tilt	3⅞	3¾
3½" Legacy Wood Valance	Wand tilt	3⅞	4
	Cordless wand tilt	3⅞	3⅞
4½" Symphony Wood Valance	Wand tilt	3⅞	4⅞
	Cordless wand tilt	3⅞	4⅞
2⅞" Wood Horizontal Blinds			
3" Classic Wood Valance	Wand tilt	3¾	4⅞
	Cordless wand tilt	3⅞	3⅞
3½" Craftsman Wood Valance	Wand tilt	3¾	4⅞
	Cordless wand tilt	3⅞	3⅞
3½" Legacy Wood Valance	Wand tilt	3¾	4⅞
	Cordless wand tilt	3⅞	4⅞
4½" Symphony Wood Valance	Wand tilt	3¾	4½
	Cordless wand tilt	3⅞	4⅞
Artisan Fabric Roman Shades			
3" Classic Wood Valance	All	4⅞	5⅞
3½" Craftsman Wood Valance	All	4⅞	5⅞
3½" Legacy Wood Valance	All	4⅞	5¼
4½" Symphony Wood Valance	All	4⅞	5⅞
Cellular, Pleated, and Fresco Roman Shades			
3" Classic Wood Valance	All	4⅞	4⅞
3½" Craftsman Wood Valance	All	4⅞	4⅞
3½" Legacy Wood Valance	All	4⅞	4½
4½" Symphony Wood Valance	All	4⅞	4⅞

†Only available with 2" barnwood blinds.

NOTE: Minimum return width is ½"; maximum return width is 8". Valance returns ½" to 1" will be glued, 1⅞" to 4⅞" will be optional glued, 4⅞" and greater cannot be glued.

Valances only available on bay or corner windows if bay or corner application is available on entire product line selected. See price list of product selected for measuring instructions. If the valance is to be used alone (no product selected), the return width must be specified at the time of the order.

General Information

Wood Valance Returns			
Valance Type	Control Type	Standard Return Inside Width (inches)	Full Recess Depth (inches)
Cellular Shade Vertical Application			
3" Classic Wood Valance	All	4¼	4⅞
3½" Craftsman Wood Valance	All	4¼	4⅞
3½" Legacy Wood Valance	All	4¼	4⅞
4½" Symphony Wood Valance	All	4¼	5
Dual Shades			
3" Classic Wood Valance*	All	5½	5⅜
3½" Craftsman Wood Valance*	All	5½	5⅜
3½" Legacy Wood Valance*	All	5½	5⅞
4½" Symphony Wood Valance	All	5½	6¼
Natural Drapes			
3" Classic Wood Valance	All	6	6⅞
3½" Craftsman Wood Valance	All	6	6⅞
3½" Legacy Wood Valance	All	6	6⅞
4½" Symphony Wood Valance	All	6	6¼
Natural Shades			
3" Classic Wood Valance	All	3⅝	3⅝
3½" Craftsman Wood Valance	All	3⅝	3⅝
3½" Legacy Wood Valance	All	3⅝	4⅞
4½" Symphony Wood Valance	All	3⅝	4⅞
Sheer Vertical Blinds			
3" Classic Wood Valance	All	6¼	6⅞
3½" Craftsman Wood Valance	All	6¼	6⅞
3½" Legacy Wood Valance	All	6¼	6⅞
4½" Symphony Wood Valance	All	6¼	7
Sliding Panels			
3" Classic Wood Valance	All	5	5⅞
3½" Craftsman Wood Valance	All	5	5⅞
3½" Legacy Wood Valance	All	5	5⅞
4½" Symphony Wood Valance	All	5	5¼

*Symphony valance recommended for better coverage.

NOTE: Minimum return width is ½"; maximum return width is 8". Valance returns ½" to 1" will be glued, 1¼" to 4⅞" will be optional glued, 4⅞" and greater cannot be glued.

Valances only available on bay or corner windows if bay or corner application is available on entire product line selected. See price list of product selected for measuring instructions. If the valance is to be used alone (no product selected), the return width must be specified at the time of the order.

General Information

Wood Valance Returns

Valance Type	Control Type	Standard Return Inside Width (inches)	Full Recess Depth (inches)
Solar and Roller Shades			
3" Classic Wood Valance	All	3¾	4¼
3½" Craftsman Wood Valance	All	3¾	4¼
3½" Legacy Wood Valance	All	3¾	4¼
4½" Symphony Wood Valance	All	3¾	4½
Vertical Blinds			
3" Classic Wood Valance	All	5½	5¼
3½" Craftsman Wood Valance	All	5½	5¼
3½" Legacy Wood Valance	All	5½	5¼
4½" Symphony Wood Valance	All	5½	6¼

NOTE: Minimum return width is ½"; maximum return width is 8". Valance returns ½" to 1" will be glued, 1¼" to 4¾" will be optional glued, 4¼" and greater cannot be glued.
 Valances only available on bay or corner windows if bay or corner application is available on entire product line selected. See price list of product selected for measuring instructions. If the valance is to be used alone (no product selected), the return width must be specified at the time of the order.

General Information

Wood Cornice Returns			
Cornice Type	Control Type	Standard Return Inside Width (inches)	Full Recess Depth (inches)
2" Wood, Aluminum, and Vinyl Horizontal Blinds			
4½" Symphony Wood Cornice	All	5	5 ¹³ / ₁₆
5½" Noble Wood Cornice	All	5	6
7½" Noble Wood Cornice	All	5	6 ⁵ / ₁₆
5½" Regal Wood Cornice	All	5	6 ⁷ / ₁₆
7½" Regal Wood Cornice	All	5	7
2¾" Wood Horizontal Blinds			
4½" Symphony Wood Cornice	All	5	5 ¹³ / ₁₆
5½" Noble Wood Cornice	All	5	6
7½" Noble Wood Cornice	All	5	6 ⁵ / ₁₆
5½" Regal Wood Cornice	All	5	6 ⁷ / ₁₆
7½" Regal Wood Cornice	All	5	7
Artisan Fabric Roman Shades			
4½" Symphony Wood Cornice	Other lift types	4 ⁷ / ₈	5 ¹¹ / ₁₆
5½" Noble Wood Cornice	Other lift types	4 ⁷ / ₈	5 ⁷ / ₈
7½" Noble Wood Cornice	Other lift types	4 ⁷ / ₈	6 ³ / ₁₆
5½" Regal Wood Cornice	Other lift types	4 ⁷ / ₈	6 ⁵ / ₁₆
7½" Regal Wood Cornice	Other lift types	4 ⁷ / ₈	6 ⁷ / ₈
Cellular, Pleated, and Fresco Roman Shades			
4½" Symphony Wood Cornice	All	4 ¹ / ₈	4 ¹⁵ / ₁₆
5½" Noble Wood Cornice	All	4 ¹ / ₈	5 ¹ / ₁₆
7½" Noble Wood Cornice	All	4 ¹ / ₈	5 ⁷ / ₁₆
5½" Regal Wood Cornice	All	4 ¹ / ₈	5 ⁵ / ₁₆
7½" Regal Wood Cornice	All	4 ¹ / ₈	6 ¹ / ₈
Cellular Shade Vertical Application			
4½" Symphony Wood Cornice	All	4 ¹ / ₄	5 ¹ / ₁₆
5½" Noble Wood Cornice	All	4 ¹ / ₄	5 ³ / ₁₆
7½" Noble Wood Cornice	All	4 ¹ / ₄	5 ⁵ / ₁₆
5½" Regal Wood Cornice	All	4 ¹ / ₄	5 ¹¹ / ₁₆
7½" Regal Wood Cornice	All	4 ¹ / ₄	6 ¹ / ₄

NOTE: Minimum return width is ½"; maximum return width is 8".

Cornices are not available on bay or corner windows. If the cornice is to be used alone (no product selected), the return width must be specified at the time of the order.

General Information

Wood Cornice Returns

Cornice Type	Control Type	Standard Return Inside Width (inches)	Full Recess Depth (inches)
Dual Shades			
4½" Symphony Wood Cornice	All	5½	6⅝
5½" Noble Wood Cornice	All	5½	6½
7½" Noble Wood Cornice	All	5½	6⅜
5½" Regal Wood Cornice	All	5½	6⅝
7½" Regal Wood Cornice	All	5½	7½
Natural Drapes			
4½" Symphony Wood Cornice	All	6	6⅜
5½" Noble Wood Cornice	All	6	7
7½" Noble Wood Cornice	All	6	7⅝
5½" Regal Wood Cornice	All	6	7⅝
7½" Regal Wood Cornice	All	6	8
Natural Shades			
4½" Symphony Wood Cornice	All	3⅝	4⅞
5½" Noble Wood Cornice	All	3⅝	4⅞
7½" Noble Wood Cornice	All	3⅝	4⅝
5½" Regal Wood Cornice	All	3⅝	5⅝
7½" Regal Wood Cornice	All	3⅝	5⅞
Sheer Vertical Blinds			
4½" Symphony Wood Cornice	All	6¼	7⅝
5½" Noble Wood Cornice	All	6¼	7¼
7½" Noble Wood Cornice	All	6¼	7⅝
5½" Regal Wood Cornice	All	6¼	7⅝
7½" Regal Wood Cornice	All	6¼	8¼
Sliding Panels			
4½" Symphony Wood Cornice	All	5	5⅜
5½" Noble Wood Cornice	All	5	6
7½" Noble Wood Cornice	All	5	6⅝
5½" Regal Wood Cornice	All	5	6⅝
7½" Regal Wood Cornice	All	5	7
Solar and Roller Shades			
4½" Symphony Wood Cornice	All	3¾	4⅞
5½" Noble Wood Cornice	All	3¾	4¾
7½" Noble Wood Cornice	All	3¾	5⅝
5½" Regal Wood Cornice	All	3¾	5⅝
7½" Regal Wood Cornice	All	3¾	5¾
Vertical Blinds			
4½" Symphony Wood Cornice	All	5½	6⅝
5½" Noble Wood Cornice	All	5½	6½
7½" Noble Wood Cornice	All	5½	6⅜
5½" Regal Wood Cornice	All	5½	6⅝
7½" Regal Wood Cornice	All	5½	7½

NOTE: Dual shades can be configured with 7½" cornices. 5½" cornices are available only when dual shade has no cassette with inside mount and cornices are outside mount.

Minimum return width is ½"; maximum return width is 8".

Cornices are not available on bay or corner windows. If the cornice is to be used alone (no product selected), the return width must be specified at the time of the order.

General Information

Composite and Faux Wood Valance Returns

Valance Type	Control Type	Standard Return Inside Width (inches)	Full Recess Depth (inches)
2" Composite and Faux Wood Horizontal Blinds			
3" Classic Composite or Faux Wood Valance	Wand tilt	3 ³ / ₁₆	3 ³ / ₁₆
	Cordless wand tilt	3 ³ / ₁₆	3 ³ / ₁₆
3" Majestic Composite or Faux Wood Valance	Wand tilt	3 ³ / ₁₆	4 ¹ / ₁₆
	Cordless wand tilt	3 ³ / ₁₆	3 ³ / ₁₆
2½" Composite and Faux Wood Horizontal Blinds			
3" Classic Composite or Faux Wood Valance	Wand tilt	3 ¹⁵ / ₁₆	4 ¹ / ₄
	Cordless wand tilt	3 ³ / ₄	4 ¹ / ₁₆
3" Majestic Composite or Faux Wood Valance	Wand tilt	3 ¹⁵ / ₁₆	4 ¹ / ₁₆
	Cordless wand tilt	3 ³ / ₄	4 ¹ / ₄
Artisan Fabric Roman Shades			
3" Classic Composite or Faux Wood Valance	All	4 ⁷ / ₈	5 ³ / ₁₆
3" Majestic Composite or Faux Wood Valance	All	4 ⁷ / ₈	5 ³ / ₁₆
Cellular, Pleated, and Fresco Roman Shades			
3" Classic Composite or Faux Wood Valance	All	4 ¹ / ₈	4 ⁷ / ₁₆
3" Majestic Composite or Faux Wood Valance	All	4 ¹ / ₈	4 ⁷ / ₁₆
Cellular Shade Vertical Application			
3" Classic Composite or Faux Wood Valance	All	4 ¹ / ₄	4 ³ / ₁₆
3" Majestic Composite or Faux Wood Valance	All	4 ¹ / ₄	4 ¹¹ / ₁₆
Dual Shades			
3" Classic Composite or Faux Wood Valance*	All	5 ¹ / ₂	5 ¹⁵ / ₁₆
3" Majestic Composite or Faux Wood Valance*	All	5 ¹ / ₂	5 ¹⁵ / ₁₆
Natural Drapes			
3" Classic Composite or Faux Wood Valance	All	6	6 ³ / ₁₆
3" Majestic Composite or Faux Wood Valance	All	6	6 ⁷ / ₁₆
Natural Shades			
3" Classic Composite or Faux Wood Valance	All	3 ⁵ / ₈	3 ¹⁵ / ₁₆
3" Majestic Composite or Faux Wood Valance	All	3 ⁵ / ₈	4 ¹ / ₁₆

*Faux wood and composite valances not recommended due to valance heights.

NOTE: Minimum return width is ½"; maximum return width is 8". Valance returns ½" to 1" will be glued, 1¹/₁₆" to 4⁵/₈" will be optional glued, 4¹¹/₁₆" and greater cannot be glued.

Valances only available on bay or corner windows if bay or corner application is available on entire product line selected. See price list of product selected for measuring instructions. If the valance is to be used alone (no product selected), the return width must be specified at the time of the order.

General Information

Composite and Faux Wood Valance Returns

Valance Type	Control Type	Standard Return Inside Width (inches)	Full Recess Depth (inches)
Sheer Vertical Blinds			
3" Classic Composite or Faux Wood Valance	All	6¼	6⅞
3" Majestic Composite or Faux Wood Valance	All	6¼	6⅞
Sliding Panels			
3" Classic Composite or Faux Wood Valance	All	5	5⅞
3" Majestic Composite or Faux Wood Valance	All	5	5⅞
Solar and Roller Shades			
3" Classic Composite or Faux Wood Valance	All	3¾	4⅞
3" Majestic Composite or Faux Wood Valance	All	3¾	4⅞
Vertical Blinds			
3" Classic Composite or Faux Wood Valance	All	5½	5⅞
3" Majestic Composite or Faux Wood Valance	All	5½	5⅞

NOTE: Minimum return width is ½"; maximum return width is 8". Valance returns ½" to 1" will be glued, 1⅞" to 4⅞" will be optional glued, 4⅞" and greater cannot be glued.

Valances only available on bay or corner windows if bay or corner application is available on entire product line selected. See price list of product selected for measuring instructions. If the valance is to be used alone (no product selected), the return width must be specified at the time of the order.

General Information

How to Measure for Valance Returns

Window depths vary considerably depending on the age and style of the window.

Always measure the window depth, regardless of the type of window treatment the client is considering. Knowing the depth when the order is placed can help prevent costly errors.

Use the information in your product information guide for wood, composite, and faux wood to calculate the needed return width (see previous pages).

To calculate the return width, use this formula:

[standard return width] minus [client window depth] =
special return length to order for inside mount blind

REMEMBER:

- Smallest return width is $\frac{1}{2}$ " (inside measurement)
- Returns $\frac{1}{2}$ " to 1" (inside measurement) will be glued; returns $1\frac{1}{16}$ " to $4\frac{5}{8}$ " (inside measurement) have the option of being glued
- The width of a return and the width of a valance are measured on the inside (back side) of the valance, not the outside (face) of the valance (see diagram at right)
- Standard return size for $2\frac{3}{8}$ " blinds—subtract $\frac{3}{16}$ " prior to determining special return width
- Standard return size for $2\frac{1}{2}$ " blinds—subtract $\frac{3}{8}$ " prior to determining special return width

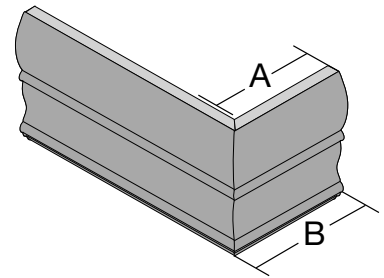

A: Inside Measurement
B: Outside Measurement

General Information

How to Measure and Order Cornices and Valances

Wood cornices and valances are optional with your custom order or as a stand-alone order.

NOTE: Cornices and valances with returns are measured and cut from the **INSIDE** of the miter to ensure the most accurate fit when installed over the headrail or window frame.

Outside Mount

- Cornices and valances are supplied with returns sized to cover the end of the blinds back to the mounting surface
- Custom returns may be ordered up to 8"; minimum return is ½"
- Cornices include a dust cover to conceal the top of the blind

Inside Mount

- Cornices and valances are supplied without returns and look best when the blinds and valance or cornice can be completely recessed
- Ends of the valance and cornice are straight-cut
- Cornices do NOT have a dust cover and returns are NOT available
- Returns for inside mount valances must be specified

Additional Ordering Information

- Please state at the time of order if the valance or cornice return measurements are for the **EXACT** size required so that no additions or deductions are made
- Cornices and valances will be shipped separately from blind
- Manufacturer recommends installing blind and valance/cornice at the same time

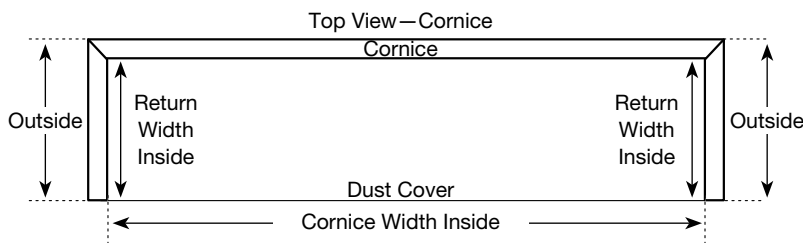

Side View—Cornice

1. Full recess is from front of cornice to wall.
2. Return width is from miter to wall.

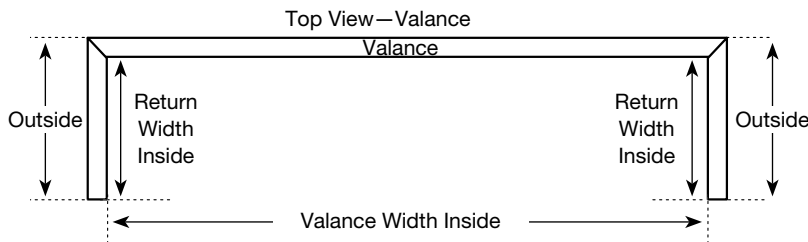
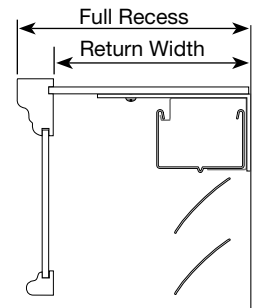

Side View—Valance

1. Full recess is from front of valance to wall.
2. Return width is from miter to wall.
3. Partial recess—subtract actual window recess from return width to arrive at exact return width.

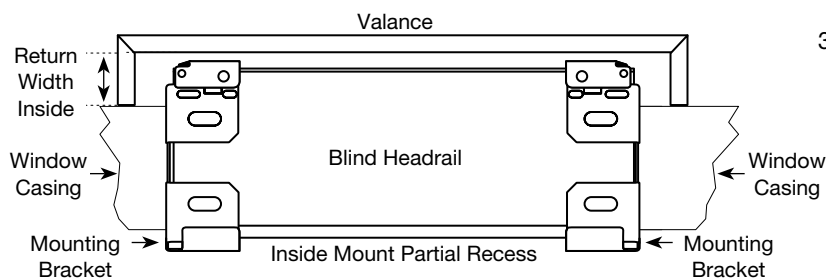
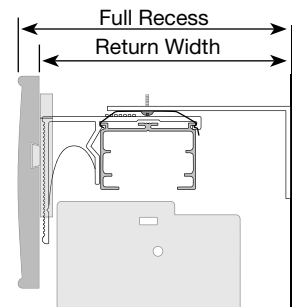

General Information

How to Measure a Special Splice Location

A keystone is supplied for valance and cornice widths that require a splice. Keystone will be equally spaced unless a special splice location is requested at time of order. The placement of the splice will be calculated by the factory using an INSIDE measurement from the mitered corner to the location specified on the order.

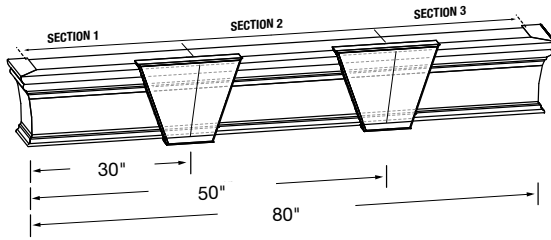

Each splice location should be recorded starting from the LEFT BACKSIDE corner.

EXAMPLE: Overall valance width = 80" backside measurement
First splice from left = 30" backside measurement
Second splice from left = 50" backside measurement

See size considerations for cornice and valance manufacturing formulas to determine exact back width size your cornice or valance will be prior to selecting splice locations.

For keystone pricing, see price charts.

NOTE: All measurements need to be from backside.

Custom Color

Graber® offers the unique option of custom color in either paint or stain. Use the following guidelines when placing your order.

With your order, please send a color chip (at least a 2" square sample) with the color name on the sample. A sample of the color can be requested before blinds are manufactured for your approval. An approval color sample will be automatically sent on orders for six or more blinds. A customer may waive their sample if they do not wish to receive one. Samples usually add approximately two (2) weeks to the lead time of an order. If a color sample is not requested, the sample you provided will be used to manufacture the wood blinds. If the color chip is to be returned to you, please note this on your order.

Please send all color chips to:

Springs Window Fashions, LLC
ATTN: Graber Custom Color
1500 Sycamore Road-G5
Montoursville, PA 17754

NOTE: Due to the nature of the custom color process, manufacturing requires an extended lead time. The standard manufacturing process does not apply. Lead-times vary depending on sizes and quantities ordered.

General Information

Mounting Brackets

Universal Cornice Mounting Bracket

- L-brackets
- Standard when ordered with
 - Any inside mount cornice
 - Outside mount cornice with returns greater than 1¾"

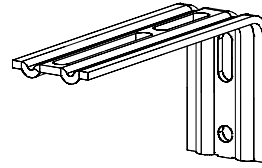

L-Bracket

Short Return Cornice Mounting Bracket

- Bracket and hanger
- Standard when ordered with
 - Outside mount cornice with return width ½" to 1¾"

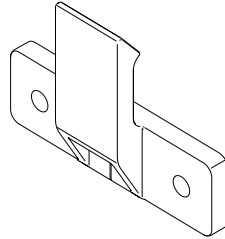

Hanger

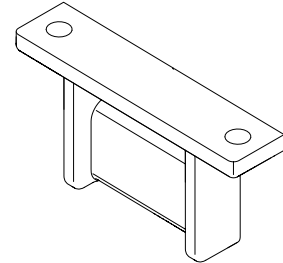

Bracket

Universal Valance Mounting Bracket

- Standard when ordered for any of the following products
 - Cellular, pleated, soft, artisan fabric Roman, fresco Roman, solar, and roller shades
 - Cellular shade vertical application
 - Dual shades
 - Sliding panels
 - Sheer vertical blinds
 - Vertical blinds
 - Natural shades or drapes
 - Other or alone

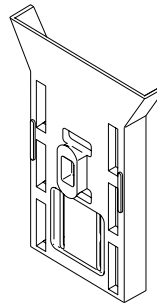

Valance Slide

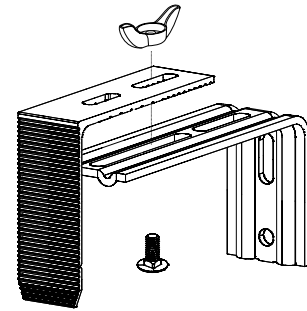

Horizontal Valance Mounting Bracket

- Clip and slide brackets
- Standard when ordered for any of the following products
 - 2" aluminum horizontal blinds
 - 2" and 2½" faux wood blinds
 - 2" vinyl horizontal blinds
 - 2", and 2⅝" wood blinds

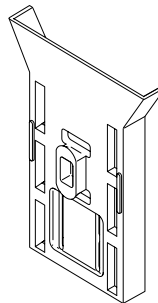

Valance Slide

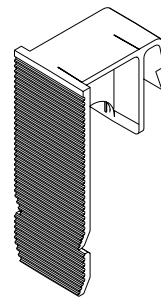

Long Valance Clip

GRABER®

Grabber is a brand of Springs Window Fashions, the Best Experience Company

Grabber and the Grabber logo are registered trademarks of Springs Window Fashions, LLC.

(08/23) |S23-464854

GRABER.

Grabber Cornices, Valances, & Palladian Window Shelf Designer US Price List — Effective January 2024

Wood Cornice Pricing

	Width up to inches (cm) →														
	23 (58.5)	30 (76.2)	36 (91.5)	42 (106.7)	48 (122)	54 (137.2)	60 (152.4)	66 (167.7)	72 (182.9)	78 (198.2)	84 (213.4)	90 (228.6)	96 (243.9)	106 (269.3)	116 (294.7)
4 1/2" (11.5 cm) Symphony Wood Cornice*	302	323	337	354	386	415	453	463	475	493	525	530	843	868	891
5 1/2" (14.0 cm) Regal Wood Cornice	376	400	415	446	475	505	544	565	584	603	661	671	1009	1043	1072
7 1/2" (19.1 cm) Regal Wood Cornice	483	510	528	553	580	603	627	654	670	706	757	811	1205	1247	1288
5 1/2" (14.0 cm) Noble Wood Cornice	315	341	358	381	415	446	483	502	518	534	571	580	914	943	969
7 1/2" (19.1 cm) Noble Wood Cornice	449	479	500	519	538	559	584	603	624	670	733	786	1180	1216	1254

	Width up to inches (cm) →															
	126 (320.1)	136 (345.5)	146 (370.9)	156 (396.3)	166 (421.7)	176 (447.1)	186 (472.5)	192 (487.7)	216 (548.7)	240 (609.6)	264 (670.6)	283 (718.9)	312 (792.5)	336 (853.5)	366 (929.7)	
4 1/2" (11.5 cm) Symphony Wood Cornice*	912	939	962	986	1009	1032	1056	1383	1402	1453	1501	1549	1897			
5 1/2" (14.0 cm) Regal Wood Cornice	1100	1131	1164	1196	1226	1259	1288	1650	1682	1744	1807	1869	2264	2323	2386	
7 1/2" (19.1 cm) Regal Wood Cornice	1333	1375	1417	1460	1503	1547	1590	1975	2014	2104	2189	2272	2702	2789	2871	
5 1/2" (14.0 cm) Noble Wood Cornice	992	1021	1047	1072	1097	1123	1148	1502	1526	1579	1632	1682	2061	2113	2164	
7 1/2" (19.1 cm) Noble Wood Cornice	1288	1329	1363	1402	1439	1478	1513	1892	1930	2006	2077	2152	2569	2641	2717	

*Maximum width 300 3/4" (764.0 cm).

NOTE: Includes returns (if requested) and mounting hardware. Minimum width 8" (20.4 cm) exact.

Decorative Cornice Keystone Pricing

Keystones are included in the price of a spliced cornice; additional keystones are available as a surcharge.

Maximum keystones on single piece cornice is 3

7 1/2" (19.1 cm) Noble and Regal	240 each
5 1/2" (14.0 cm) Noble and Regal	229 each
4 1/2" (11.5 cm) Symphony	203 each

Custom Color Pricing

Custom Color (net per color)	199
------------------------------	-----

Wood Valance Pricing

	Width up to inches (cm) →																
	24 (61)	32 (81.3)	36 (91.5)	42 (106.7)	48 (122)	54 (137.2)	60 (152.4)	66 (167.7)	72 (182.9)	78 (198.2)	84 (213.4)	90 (228.6)	96 (243.9)	106 (269.3)	116 (294.7)	126 (320.1)	136 (345.5)
3" (7.7 cm) Classic Wood Valance	54	66	74	83	88	92	103	114	119	125	136	141	147	165	181	194	206
3 1/2" (8.9 cm) Craftsman Wood Valance	57	68	81	86	92	103	107	116	124	130	141	145	151	170	187	198	212
3 1/2" (8.9 cm) Legacy Wood Valance	57	68	81	86	92	103	107	116	124	130	141	145	151	170	187	198	212
4 1/2" (11.5 cm) Symphony Wood Valance	67	75	87	93	103	114	119	125	133	143	146	152	166	191	204	220	236

	Width up to inches (cm) →																
	146 (370.9)	156 (396.3)	166 (421.7)	176 (447.1)	186 (472.5)	196 (497.9)	206 (523.3)	216 (548.7)	226 (574.1)	236 (599.5)	246 (624.9)	256 (650.3)	266 (675.7)	276 (701.1)	286 (726.5)	296 (751.9)	300 (762)
3" (7.7 cm) Classic Wood Valance	222	236	248	262	278	289	304	315	333	344	358	373	386	399	413	428	438
3 1/2" (8.9 cm) Craftsman Wood Valance	225	239	254	267	281	293	308	321	336	349	362	376	390	402	419	432	446
3 1/2" (8.9 cm) Legacy Wood Valance	225	239	254	267	281	293	308	321	336	349	362	376	390	402	419	432	446
4 1/2" (11.5 cm) Symphony Wood Valance	252	265	281	296	310	329	342	356	373	387	401	419	433	449	463	478	494

NOTE: Includes returns (if requested) and mounting hardware. Minimum width 8" (20.4 cm) exact. Maximum width 300 3/4" (764.0 cm).

Decorative Wood Valance Keystone Pricing

Keystones are included in the price of a spliced valance; additional keystones are available as a surcharge.

Maximum keystones on single valance is 3

3" (7.7 cm) Classic Wood Valance 3 1/2" (8.9 cm) Craftsman Wood Valance 3 1/2" (8.9 cm) Legacy Wood Valance 4 1/2" (11.5 cm) Symphony Wood Valance	26 each
---	---------

Custom Color Pricing

Custom Color (net per color)	199
------------------------------	-----

Composite and Faux Wood Valance Pricing

	Width up to inches (cm) →																
	24 (61)	32 (81.3)	36 (91.5)	42 (106.7)	48 (122)	54 (137.2)	60 (152.4)	66 (167.7)	72 (182.9)	78 (198.2)	84 (213.4)	90 (228.6)	96 (243.9)	106 (269.3)	116 (294.7)	126 (320.1)	136 (345.5)
3" (7.7 cm) Classic Composite and Faux Wood Valance	46	51	59	67	73	81	86	91	97	106	114	122	127	139	151	162	174
3" (7.7 cm) Majestic Composite and Faux Wood Valance	54	67	75	83	88	96	99	111	118	124	136	138	146	159	171	188	199

	Width up to inches (cm) →																
	146 (370.9)	156 (396.3)	166 (421.7)	176 (447.1)	186 (472.5)	196 (497.9)	206 (523.3)	216 (548.7)	226 (574.1)	236 (599.5)	246 (624.9)	256 (650.3)	266 (675.7)	276 (701.1)	286 (726.5)	296 (751.9)	300 (762)
3" (7.7 cm) Classic Composite and Faux Wood Valance	189	199	211	222	236	246	258	269	283	293	306	316	331	342	354	366	378
3" (7.7 cm) Majestic Composite and Faux Wood Valance	212	227	239	253	265	281	292	306	319	334	347	361	375	386	401	413	428

NOTE: Includes returns (if requested) and mounting hardware. Minimum width 8" (20.4 cm) exact. Maximum width 300 3/4" (764.0 cm).

NOTE: Spliced faux wood valances not available with keystones.

Palladian Window Shelf Pricing

	Width up to inches (cm) →												
	24 (61)	32 (81.3)	36 (91.5)	42 (106.7)	48 (122)	54 (137.2)	60 (152.4)	66 (167.7)	72 (182.9)	78 (198.2)	84 (213.4)	90 (228.6)	96 (243.9)
Palladian Window Shelf	113	149	166	196	223	253	280	307	335	362	390	419	446

NOTE: Minimum width 7" (17.8 cm) exact.