

GRABER® | DELIGHT IN EVERY DETAIL



## Graber Natural Shades English/US Price Guide

**Product Information Guide**

**Features**

Natural Shades, Natural Drapes . . . . . 2  
 Nature's Beauty of Natural Shades . . . . . 3  
 Material Styles and Information: Natural Shades and Natural Drapes . . . . . 4-5

**Size Considerations**

Natural Shades, Depth Requirements for Inside Mount, Natural Drapes, Depth Requirements for Inside Mount . . . . . 6

**Options**

Summary . . . . . 7  
 Cord Lift: Natural Shades, Continuous-Loop Lift: Natural Shades, Cordless Lift: Natural Shades . . . . . 8  
 Motorized Lift: Natural Shades, Motorized Quick Reference, Bottom Up/Top Down: Natural Shades . . . . . 9  
 Natural Drapes Control Options, Fullness: Natural Drapes . . . . . 10  
 Liners: Natural Shades and Natural Drapes, Edge Banding and Colors: Natural Shades and Natural Drapes . . . . . 11  
 Cut-outs: Natural Shades, Angle Top: Natural Shades . . . . . 12  
 Multiple Shades on One Headrail: Natural Shades . . . . . 13  
 Bay and Corner Windows . . . . . 14  
 Valance: Natural Shades, Valance: Natural Drapes, Deco-Trim Valance: Natural Shades . . . . . 15  
 Valance Returns for Standard Valances, Valance: Premiere Valance Only: Natural Shades and Natural Drapes . . . . . 16  
 Accent Gimp: Natural Shades . . . . . 17  
 Turned Headrail and Direct Mount . . . . . 18

**General Information**

Stack Charts: Natural Shades, Stack Height: Natural Shades . . . . . 19  
 Stack Charts: Natural Drapes, Natural Drapes 10% Standard Fullness Stack Chart, Natural Drapes 60% Fullness Stack Chart . . . . . 20  
 Natural Shades Product Detail . . . . . 21  
 Natural Shades Looped Roman Product Detail . . . . . 22  
 Natural Shades Cordless Lift Product Detail, Natural Shades Continuous-Loop Lift Product Detail . . . . . 23  
 Natural Drapes Product Detail . . . . . 24  
 Limited Warranty . . . . . 25

**PLEASE NOTE:**

Photos and illustrations are for inspiration only.  
 Not all product configurations are available in all countries.  
 Window blind cords are a strangulation hazard for young children.  
 Consult your dealer or store associate for cordless products, or products with inaccessible cords. Remove this product immediately if a cord longer than 22 cm, or a loop exceeding 44 cm, becomes accessible.

**VEUILLEZ NOTER :**

Les photos et les illustrations ne sont offertes qu'à titre d'inspiration.  
 Toutes les configurations de produits ne sont pas disponibles dans tous les pays.  
 Les cordons pour store de fenêtre représentent un risque d'étranglement pour les jeunes enfants. Consultez votre dépositaire ou un associé de magasin pour des produits sans cordon ou des produits dont les cordons ne sont pas accessibles.  
 Retirez ce produit immédiatement si un cordon mesurant plus de 22 cm de longueur ou une boucle dépassant 44 cm deviennent accessibles.



## Features

### Natural Shades



Graber® Tradewinds® Natural Shades are crafted from bamboo reed, slit bamboo, sisal, grass, and jute materials. They add natural color, texture, and dimension to your windows and create a comfortable atmosphere of casual elegance or simple sophistication.

- Standard Roman, old style Roman, or looped Roman shade designs
- Wide selection of colors, textures, and unique weaves
- Cord lift, cordless lift, continuous-loop lift, bottom up/top down, and motorized lift available
- 6" (15.3 cm) valance with horizontally oriented material is standard on shades except for motorized lift and continuous-loop lift
- 9" (22.9 cm) valance with horizontally oriented material is standard on shades with motorized lift and continuous-loop lift

### Natural Drapes

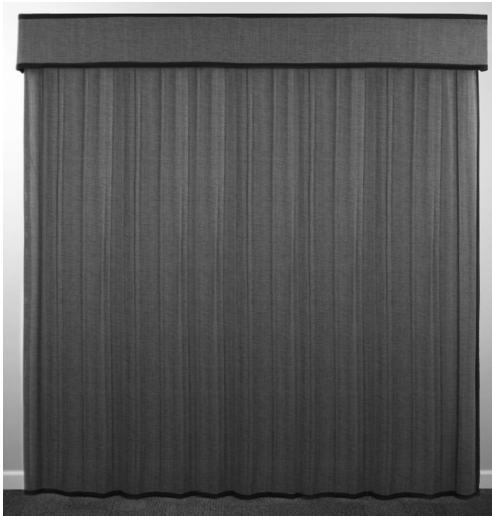

- Natural drapes feature the rolling qualities of drapery in vertically oriented natural shade material
- Features wand or corded control in single or split stack
- Choose from standard fullness (when closed, waves slightly) or a 60% fullness (when closed, features drapery-like appearance)
- Premiere valance with vertical material orientation included with drape
- Natural Drape without valance (optional, no additional charge) is not recommended, as aluminum headrail and hardware will be visible
  - Wood or fabric cornice is an option in place of valance; see wood cornice product information guide
- Valance and returns will extend  $\frac{3}{8}$ " (1.0 cm) per side on inside mount, and  $\frac{1}{16}$ " (1.5 cm) to  $\frac{5}{8}$ " (1.6 cm) per side on outside mount, further than drape width
- Edge banding required on the drapes and valance
  - 1" (2.6 cm) solid edge banding for the drapes
  - Valance uses matching 1" (2.6 cm) edge banding on vertical orientation
  - Liner is required on valance

**NOTE:** Natural Drape not available with Beachfront, Cameron, Interlude, Olympia, Purcell, Rowen, Saterra, Seasons, Terrestrial, Ventura, or Zishan

# Features

## Nature's Beauty of Natural Shades



There is simply no substitute for the beauty of the materials used in natural shades. The colors and textures of bamboo, reeds, grass, and jute have a distinct character and one-of-a-kind look that synthetic materials can't match.

### Unique Characteristics of Natural Shades

#### Asymmetry

Materials used in natural shades are naturally grown and harvested. Variations in shape, thickness, texture, and grain are to be expected from Mother Nature. While adding personality, these variations create asymmetry in the weave that may alter the appearance of the finished shades. Specifically, you may notice:

- **Uneven Spacing or Gaps**—Differences in bamboo or reed shapes and thicknesses can create uneven spacing or gaps in the weave
- **Pattern Changes or Gaps**—The varying thickness of grassy materials, tied knots, and splices can create visual disruptions in the weave pattern or gaps in the weave
- **Length Differences**—Variations in thickness, bamboo joints, or reed sizes can create length differences from both sides of the shades
- **Bowing or Arching**—Different drying rates of bamboo fibers can create a bowing or arching effect on the finished shades

To minimize variations, all materials used are hand selected to comply with strict specifications. These variations are not considered flaws, but rather normal characteristics expected from naturally grown materials.

#### Color

Evolving with age, the color of bamboo, reeds, grasses, jute, and other natural materials will change slightly. Depending on material composition, they may lighten or darken due to direct sunlight or other climatic conditions. Uncolored or natural materials will experience the most color shift, changing from a green color at harvest to a yellow-brown color over three to six months. Color matching of shades cannot be guaranteed as these are natural reactions to aging.

With character, however, comes inherent natural properties that may influence the appearance of the finished shade. Recognizing and understanding the characteristic traits of natural materials provides more satisfaction and enjoyment once you know why each shade is truly unique!

#### Stretching/Sagging

The natural elasticity of yarns, combined with the weight of the woven material, may cause shades to stretch or sag from 1" (2.6 cm) to 1½" (3.9 cm), and sliding panels to stretch or sag from 1" (2.6 cm) to 2" (5.1 cm) after installation. This is particularly noticeable on inside mount shades or shades that extend from ceiling to floor. Ordering shades shorter than needed will help compensate for stretching over time.

#### Tips

During the shipping process, the natural material may have shifted slightly due to its woven construction, causing slight shortening or uneven edges.

**Height**—If after installation, the shades are slightly shorter than ordered, grasp the bottom of the shades and gently pull to stretch to the preferred height. Some materials will also stretch by themselves over time.

**Uneven Edges**—Lightly tap edge of the shades with a flat edge (for example, a ruler) until even.

**Frayed Edges**—If threads come loose near the edges, use a sharp scissors to trim off stray threads.

#### Light Control and Privacy

**Sheer**—Allows the most amount of light into the room for a minimum amount of privacy and a view to the outside. Objects in the room can be seen quite clearly through shades.

**Light Filtering**—Allows light to gently filter through and provides privacy. Images and shapes may be seen through these shades.

Natural shades may have variations and visual inconsistencies in color, weave, grain, and texture. They may also crack or split, twist or bow, shrink or stretch, and change color over time due to aging, direct sunlight, or other climatic conditions. These unique characteristics are inherent in natural materials and are not considered defects in material or workmanship. Exact color matches cannot be guaranteed.



## Features

### Material Styles and Information: Natural Shades, Natural Drapes, and Sliding Panels\*\*\*

Style Name	Color Name	Color Number	Maximum Fabric Width (inches) (cm)	Light Control and Privacy**	Material Content	Edge Banding Requirements (Complimentary when required)
Bayport	Sand Dune	23190	96" (243.9cm)	Sheer	Bamboo/Paper/Polyester	Optional
Beachfront*	Tidepool	60040	96" (243.9cm)	Sheer	Bamboo reed	Optional
	Surf	60041				
Bellamy	Thatch	60042	96" (243.9cm)	Light Filtering	Bamboo slat, bamboo reed, jute	Optional
	Rustic Weave	80820				
Berwick	Camel	80821	96" (243.9cm)	Sheer	Ramie/Jute	Optional
	Sand Wood	43195				
Boardwalk	Pier	15968	96" (243.9cm)	Sheer to light filtering	Bamboo reed, grass, jute	Optional
	Saddlery	15962				
	Light Fossil Gray	15961				
Brooklyn	Swan	15871	96" (243.9cm)	Light Filtering	Bamboo slat, bamboo reed	Optional
	Weathered Beige	15870				
Cameron*	Cloud	65781	96" (243.9cm)	Sheer to Light Filtering	Paper	Optional
	Fairweather Blue	65782				
	Khaki Canvas	65783				
	Whole Wheat	65780				
*Cherish	Natural Sparkle	53205	96" (243.9cm)	Sheer	Linen yarn/bamboo stick/boucle yarn/lurex thread/PES thread	Optional
Denver	Flaxseed	55750	96" (243.9cm)	Light filtering	Bamboo slat, bamboo reed	Optional
	Sweet Cream	55751				
Hadley	Foggy Blue Ridge	55752	96" (243.9cm)	Sheer to Light filtering	Bamboo slat, bamboo reed, metal thread	Required
	Ivory Elegance	35910				
Inan	Silver Mist	35911	96" (243.9cm)	Sheer to light filtering	Slit bamboo, bamboo reed, jute rope	Optional
	Umber	04858				
*Interlude	Blue Ridge	83320	96" (243.9cm)	Sheer to Light Filtering	Flax/Jute	Optional
	Dusky Lilac	83321				
	Ivory Tusk	83322				
	Sand Cream	83323				
Kelton	Ivory	25891	96" (243.9cm)	Sheer	Bamboo reed	Required
	Jet Black	25892				
	Soft Coal	25893				
	True White	25890				
Lipo	Earthtones	06793	96" (243.9cm)	Sheer to light filtering	Slit bamboo, bamboo reed, jute rope	Optional
	Ambrosia	06702				
	Natural	60706				
*Merino	Grenada	55507	96" (243.9cm)	Sheer to light filtering	Bamboo reed, jute, jute braid	Optional
	Faded Star White	50510				
Moniz	Stardust	50511	96" (243.9cm)	Light filtering	Bamboo reed, grass rope	Optional
	Finland	05080				
	Peru	05081				
	Austria	05083				
*Olympia	Belgium	05084	96" (243.9cm)	Sheer	Linen yarn/bamboo stick/boucle yarn/poly thread	Required
	Natural White	38345				
Oxford	Crisp Cotton	45742	96" (243.9cm)	Sheer to Light Filtering	Bamboo, paper	Optional
	Ebony	45743				
	French Roast	45741				
	Tender Taupe	45740				
Paralian	Mink	25050	96" (243.9cm)	Light filtering	Bamboo, paper yarn	Required
	Otter	25052				
Purcell*	Golden Grain	40731	96" (243.9cm)	Sheer to Light Filtering	Jute	Optional
	Sunbleached Sand	40730				
Reminisce	Faded Slate	32360	96" (243.9cm)	Sheer to Light Filtering	Jute/Bamboo	Optional
	Faded Star White	32361				
	Fossil Gray	32363				

\*Not Available in Natural Drapes

\*\*Privacy and light control without liner; addition of privacy or room-darkening liner improves privacy and light control. All liners have a similar streetside appearance.

\*\*\*See sliding panels cost and product reference guide for more information.

## Features

### Material Styles and Information: Natural Shades, Natural Drapes, and Sliding Panels\*\*\*

Style Name	Color Name	Color Number	Maximum Fabric Width (inches) (cm)	Light Control and Privacy**	Material Content	Edge Banding Requirements (Complimentary when required)
Revelry	Dusk	80743	96" (243.9cm)	Sheer to light filtering	Bamboo reed	Optional
	Dove	80745				
	Alabaster	80746				
	Moss	80747				
	Tahoe Brown	80749				
	Blue Ridge	81742				
Rowen*	Muted Marine	81748	96" (243.9cm)	Sheer to Light Filtering	Jute	Optional
	Thundercloud	60770				
Sarto	Toasted Tan	60771	96" (243.9cm)	Sheer to Light Filtering	Bamboo reed, yarn	Optional
	Burlap	75810				
Sarterra*	Fawn	75800	96" (243.9cm)	Sheer	Jute	Optional
	Azure	03269				
*Seasons	Terrain	03370	96" (243.9cm)	Sheer	Bamboo	Optional
	Surf	03374				
	Blue Ridge	33386				
	Sedona Sands	33389				
	Faded Star White	33387				
	Sandpiper	33388				
Selene	Oatmeal	30900	96" (243.9cm)	Sheer to Light Filtering	Bamboo reed, paper	Optional
	Sophisticated Slate	30901				
Serenity	Vanilla Cream	30902	96" (243.9cm)	Light filtering	Bamboo reed	Optional
	Haze	11502				
Stateside	Admiral Navy	85832	96" (243.9cm)	Light filtering	Eucalyptus Wood	Optional
	Fossil Gray	85831				
	Tiki	85830				
	Faded Star White	85833				
Tatum	Warm Wicker	70790	96" (243.9cm)	Sheer to Light Filtering	Bamboo reed, paper	Optional
Terrestrial*	Alpaca	28001	96" (243.9cm)	Light filtering	Grass	Optional
	Camel	28003				
Toushan II	Taupe	63659	96" (243.9cm)	Light filtering	Slit bamboo, bamboo reed	Optional
*Ventura	Lake Blue	20880	96" (243.9cm)	Sheer	Bamboo reed, linen yarn	Optional
	Cabin Fever	20881				
	Marshmallow	20883				
	Genteel Gray	46460				
Verity	Suitcoat	46461	96" (243.9cm)	Sheer to Light Filtering	Bamboo/Jute	Optional
	Warm Wicker	46462				
	Faded Star White	47465				
Wild Haven	Light Fossil Gray	47466	96" (243.9cm)	Sheer to Light Filtering	Bamboo/Jute	Optional
	Porch Swing	47467				
	Sandpiper	47468				
	Stardust	43731				
Zishan*	Hut	30736	96" (243.9cm)	Light filtering	Grass, bamboo reed	Optional

\*Not Available in Natural Drape

\*\*Privacy and light control without liner; addition of privacy or room-darkening liner improves privacy and light control. All liners have a similar streetside appearance.

\*\*\*See Natural Shades, Natural Drapes, and Sliding Panels cost and product reference guide for more information.

## Size Considerations

### Natural Shades

	Width		Height	
	Minimum (inches) (cm)	Maximum (inches) (cm)	Minimum (inches) (cm)	Maximum (inches) (cm)
Standard Roman Old Style Roman	10 (25.4) outside mount 10½ (26.7) inside mount	96 (243.9) single 144 (365.8) multiple 72 (182.9) with deco-pocket accent rod	12 (30.5) 18 (45.8) with deco-pocket hem	120 (304.8)
Looped Roman	12 (30.5) outside mount 12½ (31.8) inside mount			
Bottom Up/Top Down	14 (35.6) outside mount 14½ (36.9) inside mount			
Continuous-Loop Lift	24 (61.0) outside mount 24½ (62.3) inside mount			108 (274.4)
Cordless Lift	12 (30.5) outside mount 12½ (31.8) inside mount	96 (243.9) single 144 (365.8) multiple	12 (30.5)	See price charts
Multiple Shades on One Headrail	20½ (52.1) exact	144 (365.8)	12 (30.5)	See price charts
12 volt Motorized Lift	18 (45.8) outside mount 18½ (47.0) inside mount	Determined by square feet; see motorization price list for more details.		
24 volt Motorized Lift	22 (55.9) outside mount 22½ (57.2) inside mount			

### Depth Requirements for Inside Mount

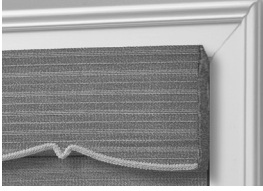
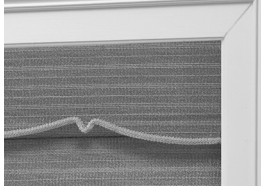

Type of Shade	Headrail Dimensions (inches) (cm)				
		Minimum Depth Mount (inches) (cm)	Flush with Casing (inches) (cm)	Minimum Depth Mount (inches) (cm)	Flush with Casing (inches) (cm)
Standard, Old Style, and Looped Roman Bottom Up/Top Down	5/8 x 1½ (1.6 x 3.9)	3/4 (2.0)	27/16 (6.2)	27/16 (6.2)	27/16 (6.2)
Cordless Lift	1½ x 2½ (3.9 x 5.4)				
Continuous-Loop Lift Motorized Lift	5/8 x 2¼ (1.6 x 5.8)				
Turned Headrail	1½ x 5/8 (3.9 x 1.6)				

### Natural Drapes

	Width		Height	
	Minimum (inches) (cm)	Maximum (inches) (cm)	Minimum (inches) (cm)	Maximum (inches) (cm)
Standard Drapery Fullness	16 (40.7) outside mount	192 (487.7)	20 (50.8)	96 (243.9)
60% Drapery Fullness	17 (43.2) inside mount			

**NOTE:** Minimum surface for outside mount: 3" (7.7 cm).

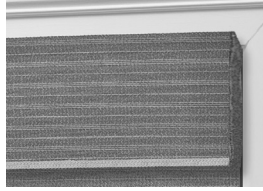
### Depth Requirements for Inside Mount

Headrail Dimensions (inches) (cm)					
		Minimum Depth Mount (inches) (cm)	Valance Flush with Casing (inches) (cm)	Minimum Depth Mount (inches) (cm)	Valance Flush with Casing (inches) (cm)
Cord Control = 7/8 x 1 1/8 (2.3 x 4.8)	Standard drapery fullness	3 3/8 (9.3)	8 (20.4)	8 (20.4)	8 (20.4)
	60% drapery fullness				
Wand Control = 7/8 x 1 1/2 (2.3 x 3.9)	Standard drapery fullness	3 3/8 (9.3)	8 (20.4)	8 (20.4)	8 (20.4)
	60% drapery fullness				



# Options

## Summary

The following is a list of options for natural shades. Most options are available in all styles and colors. Limitations will be based on fabric width and fabric type. See detailed descriptions on the following pages.

	Standard Roman	Old Style Roman	Looped Roman
Cord Lift	•	•	•
Cordless Lift	•	•	
Continuous-Loop Lift	•	•	•
Motorized Lift	•	•	
Bottom Up/Top Down	•		
Angle Top	•		
Cut-Outs	•	•	
Multiple Shades on One Headrail	•	•	•

### No Charge Options: Natural Shades

- Direct mount (no installation mounting brackets)
- Side mount brackets available up to 42" wide
- Bay or corner window
- Hold down brackets†
- 3 1/8" (8.0 cm) projection brackets
- 2" (5.1 cm) short returns
- Turned headrail
- Valances
  - 6" (15.3 cm) standard
  - 9" (22.9 cm) standard (standard with continuous-loop lift and motorized lift)
  - No valance (always optional)

### Surcharge Options: Natural Shades

- Control types
  - Cordless lift
  - Motorized lift
  - Continuous-loop lift
- Bottom up/top down
- Multiple shades on one headrail
- Specialty shades
  - Angle top
- Cut-outs
- Liners
- Edge banding\*
- Decorative cord cleats
  - Antique brass
  - Solid brass
- Cord winder
- Wood cornices/valances
- Valances
  - 9" (22.9 cm) standard
  - 6" (15.3 cm) premiere
    - Horizontal or vertical orientation
  - 9" (22.9 cm) premiere
    - Horizontal or vertical orientation
  - 9" (22.9 cm) deco-trim valance

### No Charge Options: Natural Drapes

- Control types
  - Wand control
  - Cord control
- Ceiling mount brackets
- Edge banding\*
- Valances
  - 6" (15.3 cm) premiere (standard with natural drapes)
    - Horizontal or vertical orientation
  - 9" (22.9 cm) premiere
    - Horizontal or vertical orientation
  - No valance (always optional)
- Fullness: standard (slight wave when closed)

### Surcharge Options: Natural Drapes

- Fullness: 60% (drapery-like appearance when closed)
- Liners
- Wood cornices/valances

\*Edge banding: Optional on shades or valances on most fabrics with horizontally oriented material; required on valances with vertically oriented material and designated fabrics that fray easily. Complimentary when required.

†Hold down brackets: Only available at time of order. Cannot be retrofitted. Not available with edge banding.

# Options

## Cord Lift: Natural Shades



- **No charge**
- Color coordinated cord and tassels
- Controls can be on the right or left of the shade
- Safety cord cleat provides the ability to keep the cord out of reach for children and pets
- Standard cord length is approximately  $\frac{1}{3}$  of the shade height
- 6" (15.3 cm) minimum control length
- Special length cords available as an option—no charge

## Continuous-Loop Lift: Natural Shades



Cord shown; bead chain is used on shades over 30 square feet (2.8 square meters)

- **For surcharge, see options pricing**
- Available on standard Roman, old style Roman, and looped Roman shades
- Continuous-loop lift control raises and lowers the shade and is color coordinated to the shade material
  - Shades under 30 square feet (2.8 square meters) have color coordinated cord
  - Shades over 30 square feet (2.8 square meters) will use a nickel-plated steel bead chain loop in place of cord
  - When ordering different size shades for the same room, specify if bead chain is preferred for all shades
- Allows for easier operation of larger shades
- 9" (22.9 cm) valance is standard with the continuous-loop lift option; (6" (15.3 cm) valance not available)
- Not available with bottom up/top down or angle top shades

## Cordless Lift: Natural Shades



- **For surcharge and size restrictions, see price charts**
- Available on standard Roman and old style Roman
- Cordless lift shades offer a safer alternative for homes with children and pets
- Easy to use: to lower shade, pull down; to raise shade, simply guide the shade into the desired location by gently lifting the color-coordinated wooden bottom rail
- Not available with cut-outs, bottom up/top down, or angle top shades
- 6" standard valance included at time of order with standard Roman

# Options

## Motorized Lift: Natural Shades

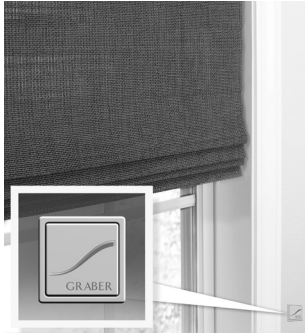

Refer to motorization price list for additional options, sizing, and pricing.

### Features

- Window treatments can be operated from virtually anywhere in the home
- Provides easy operation of hard-to-reach or large window coverings
- Efficiently manages energy (heat gain and loss)
- Operate multiple window treatments simultaneously or individually
- A safer alternative to traditional cords used to operate window coverings; ideal for homes with children and pets
- Easily integrated with home automation systems
- Low-voltage motorization requires no costly electrical hard-wiring



## Bottom Up/Top Down: Natural Shades



For surcharges, see options pricing

### Features

- Allows shades to be raised from the bottom up like a conventional shade, or operated from the top down
- Provides privacy while still allowing light in from the top of the window
- Ideal for bedrooms

### Details

- Edge banding and liner options available
  - Liner recommended for valances
- Right control will raise the bottom; left control will lower the top (standard control locations only)
- 4" (10.2 cm) seclusion strip (street side) will be applied on blinds that are inside mount to conceal the headrail component (not available on outside mount)
- Available with all valance options, 6" comes standard
- Not available with looped Roman, old style, angle top shades, continuous-loop lift, turned headrail, motorized lift, cordless lift, or multiple shades on one headrail



# Options

## Natural Drapes Control Options



### Wand Control, no charge—Default Control Type

- Ivory fiberglass wand positioned behind drape
- Stack right, left, or split
- Split stack will have 2 wands

### Cord Control, no charge—Optional

- Cord and heavy duty tension pulley hidden behind drape
- Stack right, left, or split

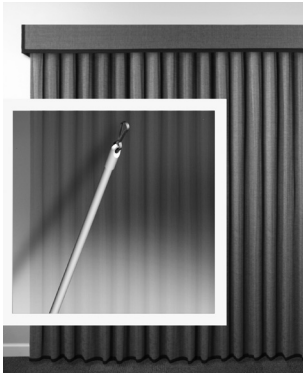

### Wand Control Chart

Finished Blind Length (inches) (cm)	Cord Control Length (inches) (cm)	Wand Length (inches) (cm)
Up to 30 (76.2)	14 (35.6)	12 (30.5)
30 <sup>1</sup> / <sub>16</sub> to 48 (76.4 to 122.0)	26 (66.1)	24 (61.0)
48 <sup>1</sup> / <sub>16</sub> to 77 (122.1 to 195.6)	38 (96.6)	36 (91.5)
77 <sup>1</sup> / <sub>16</sub> to 92 (195.8 to 233.7)	50 (127.0)	48 (122.0)
92 <sup>1</sup> / <sub>16</sub> to 96 (233.9 to 243.9)	62 (157.5)	60 (152.4)

## Fullness: Natural Drapes

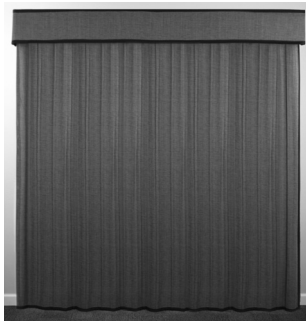

### For surcharges, see options pricing

- Standard fullness (when closed, waves slightly)
- 60% fullness (when closed, features drapery-like appearance)
- Premiere valance included at time of order; see valance options for available styles

Standard Fullness Right Stack



60% Fullness Right Stack

# Options

## Liners: Natural Shades and Natural Drapes

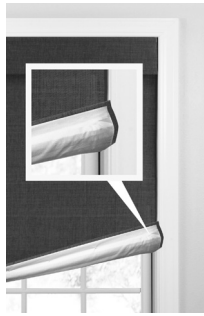

### For surcharges, see options pricing

- Liners are 100% polyester
- Available up to 96" (243.9 cm) wide on shades and 192" (487.7 cm) on drapes
- Privacy and room-darkening liner colors available
- All liners are neutral to the street
- Liner reversal available upon request

### Privacy Liner

A privacy liner is a good choice for dining rooms, living rooms, and other semi-private areas, subduing the light that enters a room. Objects appear as silhouettes from the outside. Small pinholes of light may be visible through shades with privacy liners due to the attached cord rings; see room-darkening liners for enhanced light control.

### Room-Darkening Liner

This liner blocks most incoming light and provides complete privacy. Ideal for bedrooms and media rooms.

Colors	Privacy Color Number	Room-Darkening Color Number
Cocoa	2297	6297
Taupe	2659	6659
Sand	2701	6701
Seal	2012	6012
Snow White	2909	6909

## Edge Banding and Colors: Natural Shades and Natural Drapes

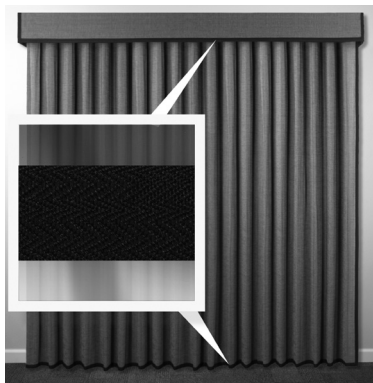

### For surcharge, see options pricing

- Edge banding adds a framed colour accent and can also eliminate material fray on edge of shade. Required on Hadley, Kelton, Olympia, and Paralian.
- 1" (2.6 cm) fabric banding is applied to sides and bottom of shade and valance
- Deco-trim valance may be ordered with edge banded shades, valance will not have edge banding
- On cordless, edgebanding is only applied to sides of shade
- See chart for colors
- Edge banding not available on angle top shades, cut-outs, or with hold down brackets

### Woven Wood Drapes

- 1" (2.6 cm) solid colors available on top and bottom of drapes: **no charge**
- Optional 1" (2.6 cm) solid colors available on drape sides: **no charge**
- Lined drapes require edge banding on all four sides
- 1" (2.6 cm) edge banding of same color will be on top and bottom edge of valance
- Use chart below for colors

Edge Banding	1" (2.6 cm) Color Number	Natural Shades	Natural Drapes
Black	7000	•	•
Cocoa	7001	•	•
Dark Beige	7005	•	•
Dove Gray	7981	•	•
Graphite	7889	•	•
Light Moss	7988	•	•
Mink Gray	7174	•	•
Sandstone	7686	•	•
Smoke	7175	•	•
Snow White	7170	•	•
Taupe	7008	•	•
Vanilla	7171	•	•

# Options

## Cut-Outs: Natural Shades



### For surcharge, see options pricing

- Available with standard and old style Roman shades
- Bottom corner cut-out (diagram A):
  - Maximum width: 6" (15.3 cm) cut-out
  - Any height (up to the headrail)
- Bottom center cut-out (diagram B):
  - Maximum height: 5" (12.7 cm) cut-out
  - Maximum width must leave 3" (7.7 cm) on each side of the cut-out
- Not available with: hold-down brackets, edge banding, bottom up/top down shades, cordless lift, continuous-loop lift, or looped Roman shades

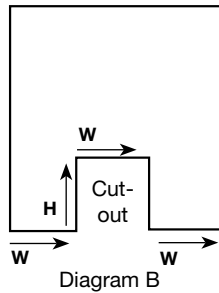
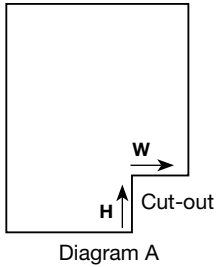

## Angle Top: Natural Shades



### For surcharges, see options pricing

- Posted manufacturing times do not apply, refer to product specialist for timing
- For angle top shades, supply all four measurements (A, B, C, D) as shown in the diagram below
- Shades will raise only to the bottom edge of the valance; the upper angled portion of the shades and valance cannot be opened and closed
- 6" (15.3 cm) and 9" (22.9 cm) standard valance only
- Valance requires gimp trim at the top edge by the headrail (A)
- Control location on low side only
- Not available with looped Roman shades, old style Roman shades, bottom up/top down, continuous-loop lift, cordless, motorized, direct mount, turned headrail, or edge banding
- Valance returns are not available

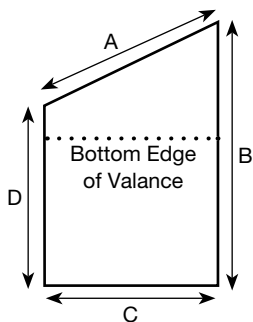

Minimum Width	18" (45.8 cm) (outside mount) 18½" (47.0 cm) (inside mount)
Maximum Straight Width	60" (152.4 cm) (outside mount) 60½" (153.7 cm) (inside mount)
Minimum Height	12" (30.5 cm)
Minimum Height (short side)	7½" (19.1 cm)
Maximum Height	86" (218.44 cm)
Maximum Degree of Angle	60°

### Measuring Outside Mount:

1. Measure exact width and height of area to be covered. It is recommended that shades overlap window frame or opening by 1½" (3.9 cm) on each side.
2. Measure height of opening on left side and mark this dimension "left". Allow for overlap as desired: 1½" (3.9 cm) on top and bottom is recommended.
3. Measure height of opening on the right side and mark this dimension "right". Allow for same overlap as left side.
4. Factory will determine the angle from these three dimensions.



# Options

## Multiple Shades on One Headrail: Natural Shades

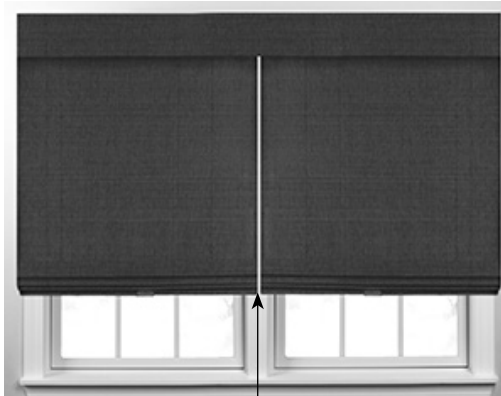

1/2" (1.3 cm) Gap

For surcharges, see options pricing

### How to Measure

1. Measure overall width of area to be covered.
2. Measure width of the area each shade is to cover; measure and specify left shade first, continuing to the right.  
**NOTE:** Minimum of 1/2" (1.3 cm) between shades for operating clearance.
3. Total width of all shades, plus clearance (gap), must equal the overall headrail width.
4. Use standard inside or outside measuring directions for height.
5. For patio doors, measure height to within 1" (2.6 cm) of the floor either from the ceiling or a point high enough above door to provide clearance; cords should be on outside edges of shades; outside mount (wall) installation is recommended for patio doors.

- Horizontal and vertical patterns will not align across shades
  - Shades operate separately
  - Controls can be on the right or left at no charge
    - Standard for two-on-one headrail: left panel—left control; right panel—right control
  - Cord Lift
    - Two-on-one available with control positions to the outside
    - Three-on-one not available on cord lift shades
  - Cordless and motorized lift
    - Two-on-one and three-on-one available
  - Continuous-loop cord lift
    - Two-on-one available with control positions to the outside
    - Three-on-one available if the lift control is combined on two shades (control positions must be to the outside)
    - Three-on-one available if the lift control is on combined on all three shades; horizontal material alignment between panels is not guaranteed
  - Liner options available
  - Edge banding is available—will be attached around each panel
  - Shades up to the maximum material width will have a continuous valance
  - Shades over maximum material width will have a valance with each panel which are butted in between each panel gap
  - Premiere valance will not be spliced at the same dimensions as the multiple blinds; premiere valances will be spliced evenly
- NOTE:** Horizontal oriented valances over 96" (243.9 cm) will be spliced in one to three places and will not align with shade panels. Vertically oriented material will be one continuous piece. Hardwood frame will be spliced at 94" (238.8 cm) with returns and 95" (241.3 cm) without returns.

# Options

## Bay and Corner Windows

- Available on standard Roman and old style Roman shades
  - Bay and corner shades are used to butt two shades together in a corner window
  - Pull cords can be on the right or left side of each shade; locating cords opposite of the corner is recommended
  - Depending on the angle, some corner shades cannot be raised to the same height
  - Bay and corner shades not available with hold-down brackets, looped Roman shades, and multiple shades on one headrail
  - Horizontal and vertical pattern alignment between shades cannot be guaranteed
  - Priced as standard shades, no additional surcharge
  - Headrails will not be mitered
  - Standard valances will not be mitered
  - Premiere valances will be mitered
- NOTE:** Manufacturer will take appropriate deduction for corner/bay windows. If deductions are not required, do not order as corner/bay.

### Measuring Information

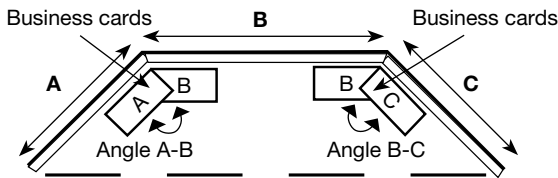
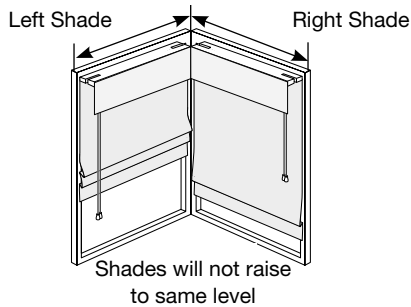

### Corner Window

Measure:  
Width of each window from corner to the point you would like to cover.

### Three-Sided Bay Window

Measure:  
A & C: Width of side windows from the corners to the point you would like the blind to cover.  
B: Width of the center window from corner to corner.  
Angle A-B: Angle between windows (A) and (B).  
Angle B-C: Angle between windows (B) and (C).

Measure bay angle using protractor or angle finder, or use two business cards in bay corner as illustrated and fax to customer service.

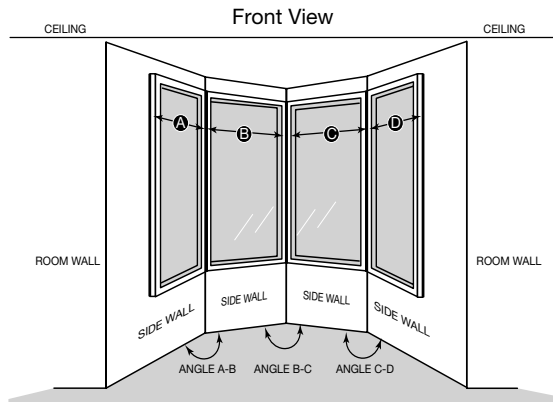

### Four-Sided Bay Window

Measure:  
A & D: Width of side windows from the corners to the point you would like the blind to cover.  
B & C: Width of each window from corner to corner.  
Angle A-B: Angle between windows (A) and (B).  
Angle B-C: Angle between windows (B) and (C).  
Angle C-D: Angle between windows (C) and (D).

Measure bay angle using protractor or angle finder, or use two business cards in bay corner as illustrated and fax to customer service.

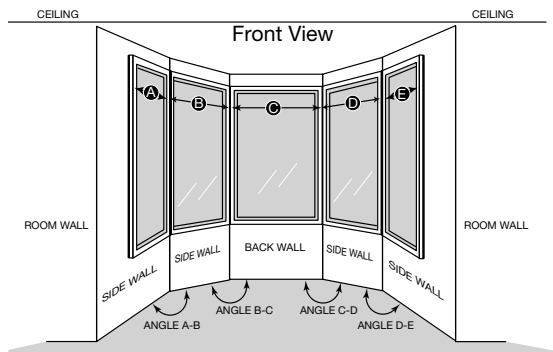

### Five-Sided Bay Window

Measure:  
A & E: Width of side windows from the corners to the point you would like the blind to cover.  
B, C & D: Width of each center window from corner to corner.  
Angle A-B: Angle between windows (A) and (B).  
Angle B-C: Angle between windows (B) and (C).  
Angle C-D: Angle between windows (C) and (D).  
Angle D-E: Angle between windows (D) and (E).

Measure bay angle using protractor or angle finder, or use two business cards as illustrated and fax to customer service.

# Options

## Valance: Natural Shades

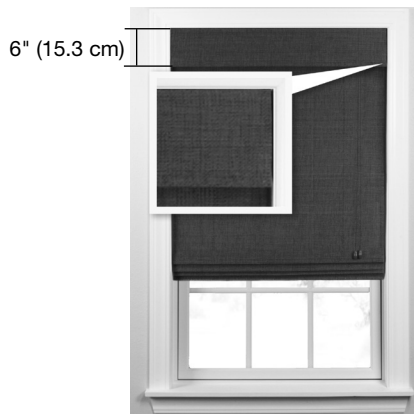

6" (15.3 cm)

Standard Valance Horizontal Orientation



Premiere Valance Option B Shown

### Cord lift and cordless no charge options

- 6" (15.3 cm) valance with shade
- No valance is optional; unfinished headrail and hardware are visible

### Continuous-loop lift and motorized lift no charge options

- 9" (22.9 cm) valance with shade (6" (15.3 cm) valance is not available)

### Additional valance information

- Edge banding will be applied to the sides and bottom of the valance if option is chosen for complete finished shades
- Liner can be added to the valance; must specify privacy or room-darkening liner and color; see price chart for surcharge

Control Type/ Shade Options with Standard Valance	Full Recess Depth Including Valance (inches) (cm)	Standard Return Width Outside Mount (inches) (cm)	Standard Return Width Inside Mount (inches) (cm)	Minimum Return Width (inches) (cm)	Maximum Return Width (inches) (cm)
Cord Lift	2 <sup>7</sup> / <sub>16</sub> (6.2)	2 <sup>1</sup> / <sub>16</sub> (5.3)	1 <sup>1</sup> / <sub>2</sub> (3.9)	1 <sup>1</sup> / <sub>2</sub> (3.9)	3 <sup>1</sup> / <sub>2</sub> (8.9)
Continuous-Loop Lift	3 <sup>3</sup> / <sub>16</sub> (8.1)	2 <sup>13</sup> / <sub>16</sub> (7.2)	2 <sup>1</sup> / <sub>4</sub> (5.8)	1 <sup>1</sup> / <sub>2</sub> (3.9)	3 <sup>1</sup> / <sub>2</sub> (8.9)
Motorized Lift*	3 <sup>3</sup> / <sub>16</sub> (8.1)	2 <sup>13</sup> / <sub>16</sub> (7.2)	2 <sup>1</sup> / <sub>4</sub> (5.8)	1 <sup>1</sup> / <sub>2</sub> (3.9)	3 <sup>1</sup> / <sub>2</sub> (8.9)
Bottom Up/Top Down	2 <sup>7</sup> / <sub>16</sub> (6.2)	2 <sup>1</sup> / <sub>16</sub> (5.3)	1 <sup>1</sup> / <sub>2</sub> (3.9)	1 <sup>1</sup> / <sub>2</sub> (3.9)	3 <sup>1</sup> / <sub>2</sub> (8.9)
Cordless Lift	2 <sup>7</sup> / <sub>16</sub> (7.3)	2 <sup>7</sup> / <sub>16</sub> (6.2)	2 <sup>7</sup> / <sub>16</sub> (6.2)	1 <sup>1</sup> / <sub>2</sub> (3.9)	3 <sup>1</sup> / <sub>2</sub> (8.9)

\*See motorized product information guide for more details.

- Special 2" (5.1 cm) valance return **length**: available upon request
- No liner or edge banding on valance returns

## Valance: Natural Drapes

- No charge for premiere valance at time of order (must select option)
- Liner required on Natural Drape valance
- No valance is optional; aluminum headrail and hardware are visible
- Valance return height will match valance height option chosen

## Deco-Trim Valance: Natural Shades

### Seascape



This design is scaled to the width of the shade

### Dentil



This design will repeat with the width of the shade

### Cathedral



This design will repeat with the width of the shade

### Horizon



This design is scaled to the width of the shade

### For surcharge, see options pricing

- Distinctive valance designs with accent gimp
- Deco-trim valance designs are cut into the valance of the shade to a depth of approximately 2<sup>1</sup>/<sub>2</sub>" (6.4 cm)
- 9" (22.9 cm) deco-trim valance is measured from the top of the headrail to the lowest point
- Accent gimp must be selected with deco-trim valance
- Available with 9" (22.9 cm) valance only

# Options

## Valance Returns for Standard Valances

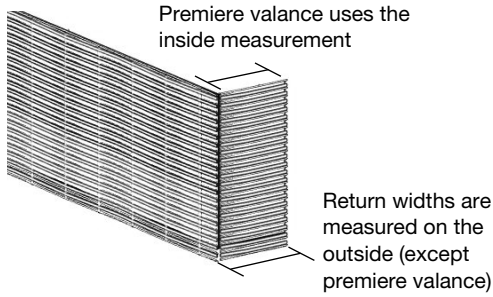

Window depths vary considerably depending on the age and style of the window. **Always** measure the window depth, regardless of the type of window treatment the client is considering. Knowing the depth when the order is placed can help prevent costly errors.

To calculate the return width, use this formula:

$$[\text{Standard return width}] \text{ minus } [\text{client window depth}] = \text{special return width to order for inside mount blind}$$

## Valance: Premiere Valance Only: Natural Shades and Natural Drapes

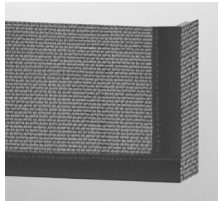

Option A

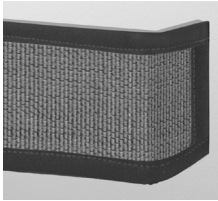

Option B

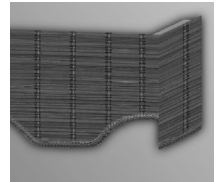

Option C

### Premiere valance only

- No charge option for natural drape at time of order

Natural material is mounted to a North American hardwood frame with mitered corner returns that attach separately. Valance upgrade options provide stable returns and a clean, uniform appearance.

- Valance can be ordered for use alone or to complement other window treatments
- Valance material is attached to a hardwood frame; includes valance clips to mount valance
- Valance returns are available (must be specified at the time of the order)
- Valance returns are standard on outside mount natural premiere valance based on headrail depth

Control Type/ Shade Options with Premiere Valance	Full Recess Depth Including Valance (inches) (cm)	Minimum Return Width (inches) (cm)	Return Width Inside/ Outside Mount— Standard Mounting Brackets (inches) (cm)	Return Width Inside/ Outside Mount— 2" (5.1 cm) Extension Brackets (inches) (cm)	Return Width Inside/ Outside Mount— 2 5/8" (6.7 cm) Extension Brackets (inches) (cm)	Return Width Inside/ Outside Mount— 3 1/2" (8.9 cm) Extension Brackets (inches) (cm)
Cord Lift	2 7/16 (6.2)	1 1/2 (3.9)	2 13/16 (7.2)	3 3/4 (9.6)	4 7/16 (11.3)	5 1/4 (13.4)
Continuous- Loop Lift	3 3/16 (8.1)	1 1/2 (3.9)	3 3/16 (9.1)	4 1/2 (11.5)	5 1/8 (13.1)	6 (15.3)
Motorized Lift*	3 3/16 (8.1)	1 1/2 (3.9)	3 3/16 (9.1)	4 1/2 (11.5)	5 1/8 (13.1)	6 (15.3)
Bottom Up/ Top Down	2 7/16 (6.2)	1 1/2 (3.9)	2 13/16 (7.2)	3 3/4 (9.6)	4 7/8 (12.4)	5 1/4 (13.4)
Cordless Lift	4 1/4 (10.8)	1 1/2 (3.9)	3 3/4 (8.3)	4 (10.2)	4 9/16 (11.6)	5 1/2 (14.0)
Drape	8 (20.4)	2 (5.1)	6 1/2 (16.6)	N/A	N/A	N/A

\*See motorized product information guide for more details.

- Valances over maximum material width will be butted
- Edge banding is available on 6" (15.3 cm) or 9" (22.9 cm) horizontal or vertical oriented material; not available on deco-trim
- No liner or edge banding on valance returns

### Options:

- 6" (15.3 cm) or 9" (22.9 cm) valance with horizontally material orientation; edge banding is optional (6" (15.3 cm) not available with motorized lift and continuous-loop lift).
- 6" (15.3 cm) or 9" (22.9 cm) valance with vertical material orientation; 1" (2.6 cm) edge banding top and bottom mandatory (6" (15.3 cm) not available with motorized lift and continuous-loop lift).
- 9" (22.9 cm) deco-trim valance; no vertical orientation option (must select accent gimp).
- Wood cornice: See cornices and valances price list.

**NOTE:** Horizontal oriented valances over 96" (243.9 cm) will be spliced in one to three places and will not align with shade panels. Vertically oriented material will be one continuous piece. Hardwood frame will be spliced at 94" (238.8 cm) with returns and 95" (241.3 cm) without returns.

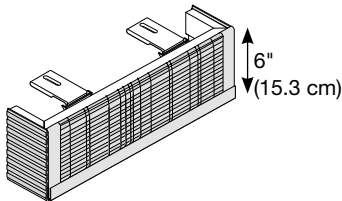

Valance less than 96" (243.9 cm)

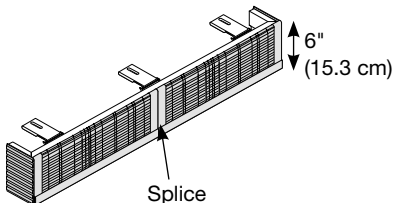

Valance over 96" (243.9 cm)



# Options

## Accent Gimp: Natural Shades

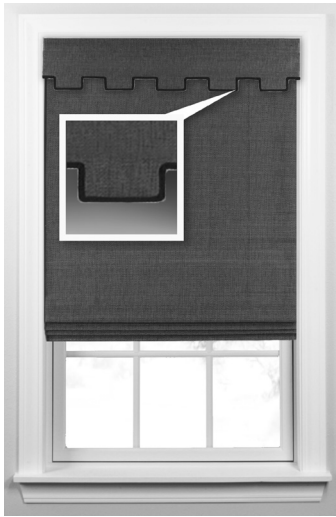

**For surcharges, see price charts**

- Required with 9" (22.9 cm) deco-trim valance; optional on other horizontal material orientation valances and standard hems
- Not available with vertically-oriented material



**NOTE:** Must choose accent gimp color when a deco-trim style has been selected for the valance or hem.

Black . . . . .	156	Rock Gray . . . . .	399
Chocolate . . . . .	04	Tender Taupe . . . . .	103
Cream . . . . .	715	Toffee . . . . .	296
Dark Beige. . . . .	350	White . . . . .	417

## Options

### Turned Headrail: Natural Shades

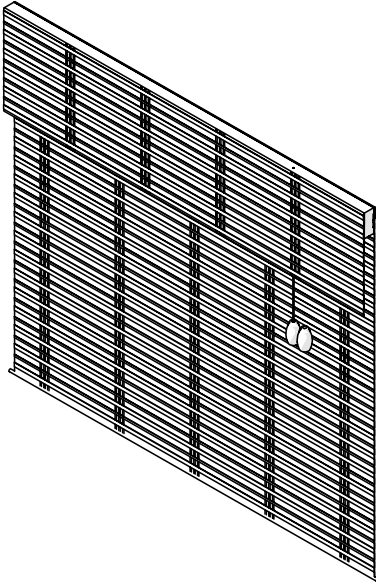

- **No charge**
- Headrail turned 90 degrees to allow for a smaller inside mount shade or for use on French doors
- Available as inside or outside mount; headrail mounted by placing mounting screws through headrail directly into mounting surface
- Minimum depth required: ¾" (2.0 cm)
- Available as Standard and Old Style Roman with standard cord lift
- 6" (15.3 cm) standard or 9" (22.9 cm) deco-trim valance available options; see price charts for surcharge
- Not available with cordless lift, motorized lift, bay or corner windows, bottom up/top down
- **Valance returns are not available**

### Direct Mount: Natural Shades

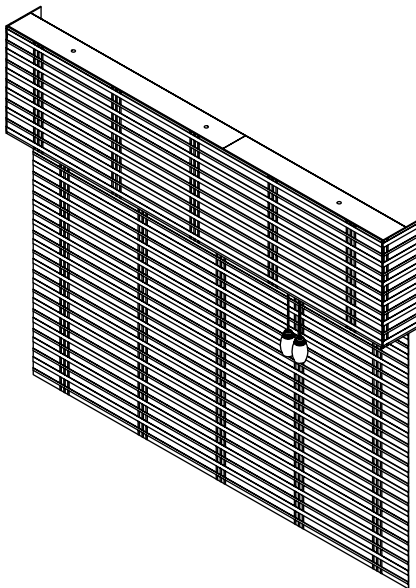

- **No charge**
- Option to remove metal mounting plates on shades with a wood headrail and mount directly to mounting surface
- Shade will come factory predrilled mounting holes in the wood headrail
- Available as inside or outside mount, headrail mounted by placing mounting screws through the headrail directly into the mounting surface.
- Minimum depth required: ¾" (2.0 cm)
- Available on corded lift, motorized lift, continuous cord loop, angle top, bay and corner windows
- Available in Standard Roman, Old Style Roman, and Looped shade styles.
- Available with all valance and return options.
- Not available on cordless lift
- 6" (15.3 cm) standard or 9" (22.9 cm) deco-trim valance available options; see price charts for surcharge
- Returns are available

# General Information

## Stack Charts: Natural Shades

**NOTE:** For shades, stack height is measured from the top of the headrail to the lowest point of the shades when completely raised. Stack heights are approximate and will vary by material.

### Stack Height: Natural Shades

	Height of Shade up to (inches) (cm)	Standard Hem		Deco-Trim Hem Deco-Pocket Hem	
		No Liner (inches) (cm)	Privacy or Room-Darkening Liner (inches) (cm)	No Liner (inches) (cm)	Privacy or Room-Darkening Liner (inches) (cm)
Cord Lift • Standard Roman • Old Style Roman • Turned Headrail Roman	30 (76.2)	8¾-9¼ (22.3-24.8)	8¾-10 (22.3-25.4)	13¾-14¾ (35.0-37.5)	13¾-14¾ (35.0-37.5)
	50 (127.0)	10¼-10½ (26.1-26.7)	10¼-10½ (26.1-26.7)	15-15¼ (38.1-38.8)	15-15¼ (38.1-38.8)
	70 (177.8)	10¾-11 (27.4-28.0)	10¾-11¼ (27.4-28.6)	15½-15¾ (39.4-40.1)	15½-15¾ (39.4-40.1)
	90 (228.6)	11¼-11½ (28.6-29.3)	11½-11¾ (29.3-29.9)	16-16¼ (40.7-41.3)	16-16¼ (40.7-41.3)
	110 (279.4)	11¾-12 (29.9-30.5)	12-12¼ (30.5-31.2)	16½-16¾ (42.0-42.6)	16½-16¾ (42.0-42.6)
	120 (304.8)	12-12½ (30.5-31.8)	12¼-12½ (31.2-31.8)	17-17¼ (43.2-43.9)	17-17¼ (43.2-43.9)
Continuous-Loop Lift Motorized Lift • Standard Roman • Old Style Roman	30 (76.2)	9¾-10 (24.8-25.4)	9¾-10¼ (24.8-26.1)	14½-15 (36.9-38.1)	14½-15 (36.9-38.1)
	50 (127.0)	10¼-10¾ (26.1-27.4)	10½-11 (26.7-28.0)	15¼-15¾ (38.8-40.1)	15¼-15¾ (38.8-40.1)
	70 (177.8)	11-11¼ (28.0-28.6)	11¼-11½ (28.6-29.3)	16-16¼ (40.7-41.3)	16-16¼ (40.7-41.3)
	90 (228.6)	11½-11¾ (29.3-29.9)	11¾-12 (29.9-30.5)	16½-16¾ (42.0-42.6)	16½-16¾ (41.3-42.6)
	110 (279.4)	12-12¼ (30.5-31.2)	12¼-12½ (31.2-31.8)	17-17¼ (43.2-43.9)	17-17¼ (43.2-43.9)
	120 (304.8)	12½-12¾ (31.8-32.4)	12¾-13 (32.4-33.1)	17½-17¾ (44.5-45.1)	17½-17¾ (44.5-45.1)
Cord Lift • Looped Roman	30 (76.2)	9¾-10½ (24.8-26.7)	9¾-10¾ (24.8-27.4)	14½-15 (36.9-38.1)	14½-15¼ (36.9-38.8)
	50 (127.0)	10¾-11¼ (27.4-29.9)	11-12 (28.0-30.5)	15¼-16¼ (38.8-41.3)	15¾-16¼ (40.1-42.6)
	70 (177.8)	12-13 (30.5-33.1)	12¼-13 (31.2-33.1)	16½-17¼ (42.0-43.9)	17-17¾ (43.2-45.1)
	90 (228.6)	13¼-14 (33.7-35.6)	13¾-14¼ (33.7-36.2)	17½-18½ (44.5-47.0)	18-19 (45.8-48.3)
	110 (279.4)	14¼-14½ (36.2-36.9)	14½-15 (36.9-38.1)	18¾-19¼ (47.7-48.9)	19¼-20 (48.9-50.8)
	120 (304.8)	14¾-15 (37.5-38.1)	15¼-15¾ (38.8-40.1)	19½-19¾ (49.6-50.2)	20-20¼ (50.8-51.5)
Continuous-Loop Lift • Looped Roman	30 (76.2)	10¾-11 (27.4-28.0)	10¾-11¼ (27.4-28.6)	15½-16¼ (39.4-41.3)	15½-16¼ (39.4-41.3)
	50 (127.0)	11¼-12¼ (28.6-31.2)	11½-13¼ (29.3-33.7)	16½-17 (42.0-43.2)	16½-17½ (42.0-44.5)
	70 (177.8)	12½-13¾ (31.8-35.0)	13½-14¼ (34.3-36.2)	17¼-18 (43.9-45.8)	17¾-18¾ (45.1-47.7)
	90 (228.6)	14-14½ (35.6-36.9)	14½-15¼ (36.9-38.8)	18¼-19 (46.4-48.3)	19-20 (48.3-50.8)
	110 (279.4)	14¾-15¼ (37.5-38.8)	15½-16¼ (39.4-41.3)	19¼-20 (48.9-50.8)	20¼-21 (51.5-53.4)
	120 (304.8)	15½-15¾ (39.4-40.1)	16½-16¾ (42.0-42.6)	20¼-20½ (51.5-52.1)	21¼-21½ (54.0-54.7)
Cord Lift • Bottom Up/Top Down Roman	30 (76.2)	10¾-11 (27.4-28.0)	10¾-11 (27.4-28.0)	15½-15¾ (39.4-40.1)	15½-15¾ (39.4-40.1)
	50 (127.0)	11¼-11½ (28.6-29.3)	11¼-11½ (28.6-29.3)	16-16¼ (40.7-41.3)	16-16¼ (40.7-41.3)
	70 (177.8)	11¾-12 (29.9-30.5)	11¾-12 (29.9-30.5)	16½-16¾ (42.0-42.6)	16½-16¾ (42.0-42.6)
	90 (228.6)	12¼-12½ (31.2-31.8)	12¼-12½ (31.2-31.8)	17-17¼ (43.2-43.9)	17-17¼ (43.2-43.9)
	110 (279.4)	12¾-13 (32.4-33.1)	12¾-13 (32.4-33.1)	17½-17¾ (44.5-45.1)	17½-17¾ (44.5-45.1)
	120 (304.8)	13¼-13½ (33.7-34.3)	13¼-13½ (33.7-34.3)	17¾-18 (45.1-45.8)	17¾-18 (45.1-45.8)
Cordless Lift • Standard Roman • Old Style Roman	30 (76.2)	8¾-9¼ (22.3-24.8)	8¾-10 (22.3-25.4)		
	50 (127.0)	10¼-10½ (26.1-26.7)	10¼-10½ (26.1-26.7)		
	70 (177.8)	10¾-11 (27.4-28.0)	10¾-11¼ (27.4-28.6)		
	90 (228.6)	11¼-11½ (28.6-29.3)	11½-11¾ (29.3-29.9)	N/A	N/A
	110 (279.4)	11¾-12 (29.9-30.5)	12-12¼ (30.5-31.2)		
	120 (304.8)	12-12½ (30.5-31.8)	12¼-12½ (31.2-31.8)		

# General Information

## Stack Charts: Natural Drapes

**NOTE:** For drapes, stack width is measured from the outside of the drapes to the inside of the drapes. Stack widths are approximate and will vary by material.

### Natural Drapes 10% Standard Fullness Stack Chart

Width of Shade up to (inches) (cm)	Cord Control				Wand Control			
	Single Stack		Split Stack, Each Side		Single Stack		Split Stack, Each Side	
	Minimum Range Thinner Fabrics (inches) (cm)	Minimum Range Thicker Fabrics (inches) (cm)	Minimum Range Thinner Fabrics (inches) (cm)	Minimum Range Thicker Fabrics (inches) (cm)	Minimum Range Thinner Fabrics (inches) (cm)	Minimum Range Thicker Fabrics (inches) (cm)	Minimum Range Thinner Fabrics (inches) (cm)	Minimum Range Thicker Fabrics (inches) (cm)
27 (68.6)	5-7 (12.7-17.8)	7-9 (17.8-22.9)	3-4 (7.7-10.2)	5-6 (12.7-15.3)	6½-9 (16.6-22.9)	9-12 (22.9-30.5)	5½-7½ (14.0-19.1)	7½-9½ (19.1-24.2)
40 (101.6)	7-9 (17.8-22.9)	9-13 (22.9-33.1)	4-5 (10.2-12.7)	6-7 (15.3-17.8)	9-11 (22.9-28.0)	12-15 (30.5-38.1)	7½-9 (19.1-22.9)	9½-11½ (24.2-29.3)
51 (129.6)	9-11 (22.9-28.0)	13-16 (33.1-40.7)	5-6 (12.7-15.3)	7-8 (17.8-20.4)	11-14 (28.0-35.6)	15-18 (38.1-45.8)	9-10½ (22.9-26.7)	11½-13½ (29.3-34.3)
63 (160.1)	11-13 (28.0-33.1)	16-19 (40.7-48.3)	6-7 (15.3-17.8)	8-9 (20.4-22.9)	14-16 (35.6-40.7)	18-21 (45.8-53.4)	10½-12 (26.7-30.5)	13½-15 (34.3-38.1)
75 (190.5)	13-15 (33.1-38.1)	19-22 (48.3-55.9)	7-8 (17.8-20.4)	9-10 (22.9-25.4)	16-18 (40.7-45.8)	21-24 (53.4-61.0)	12-13½ (30.5-34.3)	15-16½ (38.1-42.0)
88 (223.6)	15-17 (38.1-43.2)	22-25 (55.9-63.5)	8-9 (20.4-22.9)	10-12 (25.4-30.5)	18-20 (45.8-50.8)	24-27 (61.0-68.6)	13½-14½ (34.3-36.9)	16½-18 (42.0-45.8)
102 (259.1)	17-19 (43.2-48.3)	25-28 (63.5-71.2)	9-10 (22.9-25.4)	12-14 (30.5-35.6)	20-22 (50.8-55.9)	27-30 (68.6-76.2)	14½-15 (36.9-38.1)	18-19½ (45.8-49.6)
115 (292.1)	19-21 (48.3-53.4)	28-31 (71.2-78.8)	10-11 (25.4-28.0)	14-16 (35.6-40.7)	22-24 (55.9-61.0)	30-33 (76.2-83.9)	15½-16½ (39.4-42.0)	19½-21 (49.6-53.4)
128 (325.2)	21-23 (53.4-58.5)	31-34 (78.8-86.4)	11-12 (28.0-30.5)	16-18 (40.7-45.8)	24-26 (61.0-66.1)	33-36 (83.9-91.5)	16½-18 (42.0-45.8)	21-22½ (53.4-57.2)
141 (358.2)	23-25 (58.5-63.5)	34-37 (86.4-94.0)	12-13 (30.5-33.1)	18-20 (45.8-50.8)	26-28 (66.1-71.2)	36-39 (91.5-99.1)	18-19 (45.8-48.3)	22½-24 (57.2-61.0)
157 (398.8)	25-27 (63.5-68.6)	37-40 (94.0-101.6)	13-14 (33.1-35.6)	20-22 (50.8-55.9)	28-30 (71.2-76.2)	39-43 (99.1-109.3)	19-21 (48.3-53.4)	24-25 (61.0-63.5)
170 (431.8)	27-29 (68.6-73.7)	40-43 (101.6-109.3)	14-15 (35.6-38.1)	22-24 (55.9-61.0)	30-32 (76.2-81.3)	43-46 (109.3-116.9)	21-22 (53.4-55.9)	25-26 (63.5-66.1)
183 (464.9)	29-31 (73.7-78.8)	43-46 (109.3-116.9)	15-16 (38.1-40.7)	24-26 (61.0-66.1)	32-35 (81.3-88.9)	46-49 (116.9-124.5)	22-23 (55.9-58.5)	26-27 (66.1-68.6)
192 (487.7)	31-33 (78.8-83.9)	46-49 (116.9-124.5)	16-17 (40.7-43.2)	26-28 (66.01-71.2)	35-37 (88.9-94.0)	49-53 (124.5-134.7)	23-24 (58.5-61.0)	27-28 (68.6-71.2)

### Natural Drapes 60% Fullness Stack Chart

Width of Shade up to (inches) (cm)	Cord Control				Wand Control			
	Single Stack		Split Stack, Each Side		Single Stack		Split Stack, Each Side	
	Minimum Range Thinner Fabrics (inches) (cm)	Minimum Range Thicker Fabrics (inches) (cm)	Minimum Range Thinner Fabrics (inches) (cm)	Minimum Range Thicker Fabrics (inches) (cm)	Minimum Range Thinner Fabrics (inches) (cm)	Minimum Range Thicker Fabrics (inches) (cm)	Minimum Range Thinner Fabrics (inches) (cm)	Minimum Range Thicker Fabrics (inches) (cm)
27 (68.6)	6-8½ (15.3-21.6)	8½-14 (21.6-35.6)	3½-6 (8.9-15.3)	6-9 (15.3-22.9)	8-12 (20.4-30.5)	11-16 (28.0-40.7)	7-9 (17.8-22.9)	9-12 (22.9-30.5)
40 (101.6)	8½-13 (21.6-33.1)	14-18 (35.6-45.8)	6-8 (15.3-20.4)	9-12 (22.9-30.5)	12-15 (30.5-38.1)	16-21 (40.7-53.4)	9-11 (22.9-28.0)	12-14 (30.5-35.6)
51 (129.6)	13-15½ (33.1-39.4)	18-22 (45.8-55.9)	8-10 (20.4-25.4)	12-14 (30.5-35.6)	15-18 (38.1-45.8)	21-25 (53.4-63.5)	11-13 (28.0-33.1)	14-16 (35.6-40.7)
63 (160.1)	15½-18 (39.4-45.8)	22-27 (55.9-68.6)	10-12 (25.4-30.5)	14-17 (35.6-43.2)	18-21 (45.8-53.4)	25-30 (63.5-76.2)	13-15 (33.1-38.1)	16-18 (40.7-45.8)
75 (190.5)	18-22 (45.8-55.9)	27-31 (68.6-78.8)	12-14 (30.5-35.6)	17-19 (43.2-48.3)	21-24 (53.4-61.0)	30-35 (76.2-88.9)	15-17 (38.1-43.2)	18-20 (45.8-50.8)
88 (223.6)	22-25 (55.9-63.5)	31-37 (78.8-94.0)	14-16 (35.6-40.7)	19-22 (48.3-55.9)	24-27 (61.0-68.6)	35-40 (88.9-101.6)	17-19 (43.2-48.3)	20-22 (50.8-55.9)
102 (259.1)	25-29 (63.5-73.7)	37-41 (94.0-104.2)	16-18 (40.7-45.8)	22-25 (55.9-63.5)	27-30 (68.6-76.2)	40-44 (101.6-111.8)	19-21 (48.3-53.4)	22-25 (55.9-63.5)
115 (292.1)	29-32 (73.7-81.3)	41-46 (104.2-116.9)	18-20 (45.8-50.8)	25-28 (63.5-71.2)	30-34 (76.2-86.4)	44-49 (111.8-124.5)	21-23 (53.4-58.5)	25-28 (63.5-71.2)
128 (325.2)	32-35 (81.3-88.9)	46-51 (116.9-129.6)	20-22 (50.8-55.9)	28-31 (71.2-78.8)	34-38 (86.4-96.6)	49-54 (124.5-137.2)	23-25 (58.5-63.5)	28-30 (71.2-76.2)
141 (358.2)	35-38 (88.9-96.6)	51-56 (129.6-142.3)	22-24 (55.9-61.0)	31-33 (78.8-83.9)	38-42 (96.6-106.7)	54-60 (137.2-152.4)	25-27 (63.5-68.6)	30-32 (76.2-81.3)
157 (398.8)	38-42 (96.6-106.7)	56-62 (142.3-157.5)	24-26 (61.0-66.1)	33-35 (83.9-88.9)	42-46 (106.7-116.9)	60-66 (152.4-167.7)	27-29 (68.6-73.7)	32-36 (81.3-91.5)
170 (431.8)	42-46 (106.7-116.9)	62-67 (157.5-170.2)	26-28 (66.1-71.2)	35-38 (88.9-96.6)	46-49 (116.9-124.5)	66-71 (167.7-180.4)	29-31 (73.7-78.8)	36-38 (91.5-96.6)
183 (464.9)	46-49 (116.9-124.5)	67-72 (170.2-182.9)	28-30 (71.2-76.2)	38-40 (96.6-101.6)	49-52 (124.5-132.1)	71-75 (180.4-190.5)	31-33 (78.8-83.9)	38-40 (96.6-101.6)
192 (487.7)	49-51 (124.5-129.6)	72-76 (182.9-193.1)	30-32 (76.2-81.3)	40-42 (101.6-106.7)	52-55 (132.1-139.7)	75-80 (190.5-203.2)	33-36 (83.9-91.5)	40-43 (101.6-109.3)



# General Information

## Natural Shades Product Detail

### Standard Roman

#### Valance

- 6" (15.3 cm) valance is standard on standard and looped Roman
- No valance on old style Roman

#### Hold Down Brackets (optional)

- Secure bottomrail to door, wall, or window sill; must be specified at time of order

#### Hardwood Headrail

- Made from sustainable hardwood resources

#### Standard Installation Brackets

- Steel

#### Mounting Plate

- Aluminum

#### Lift Cord

- Color coordinated 1.8 mm cord with filler for durability

#### Wood Tassel

- Color coordinated to the shade

#### Safety Cord Cleat

- Prevents cord from twisting and enhances safety in homes with children and pets
- Standard clear cord cleat (included)
- Decorative cord cleat (solid brass or antique brass)

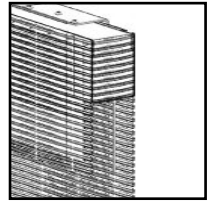

2" (5.1 cm)  
Short Return

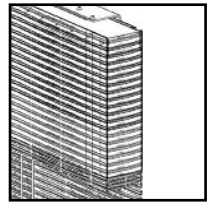

Standard 6" (15.3 cm)  
Return

### Standard Roman Turned Headrail

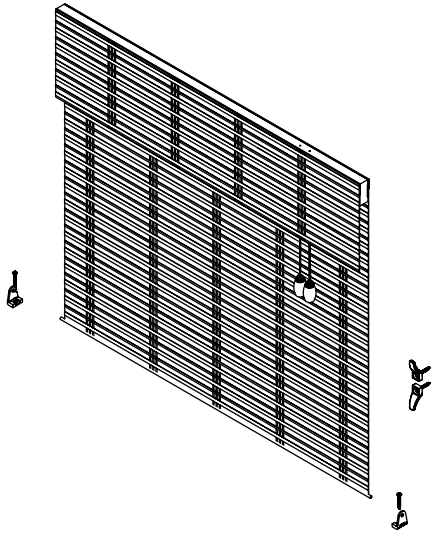

(Direct mount shade; no returns available)

### Old Style Roman

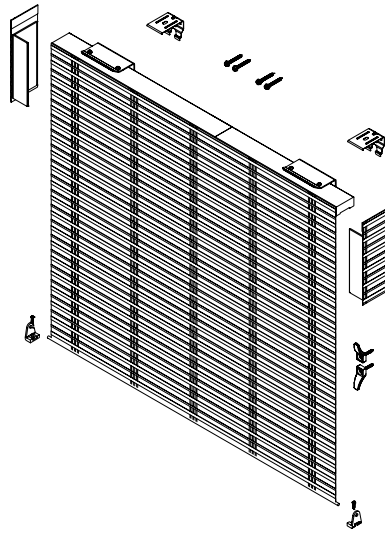

Cord lift (lift cords are behind the shade; outside mount shown).  
4" (10.2 cm) seclusion strip is used on inside mount.

### Bottom Up/Top Down

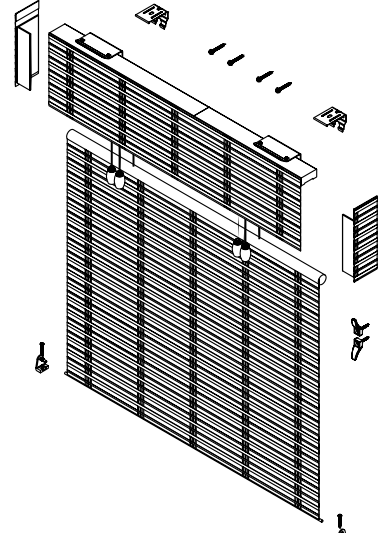

4" (10.2 cm) seclusion strip is used on inside mount.

#### Cord Winder



#### Decorative Cord Cleats



Solid Brass



Antique Brass

# General Information

## Natural Shades Looped Roman Product Detail

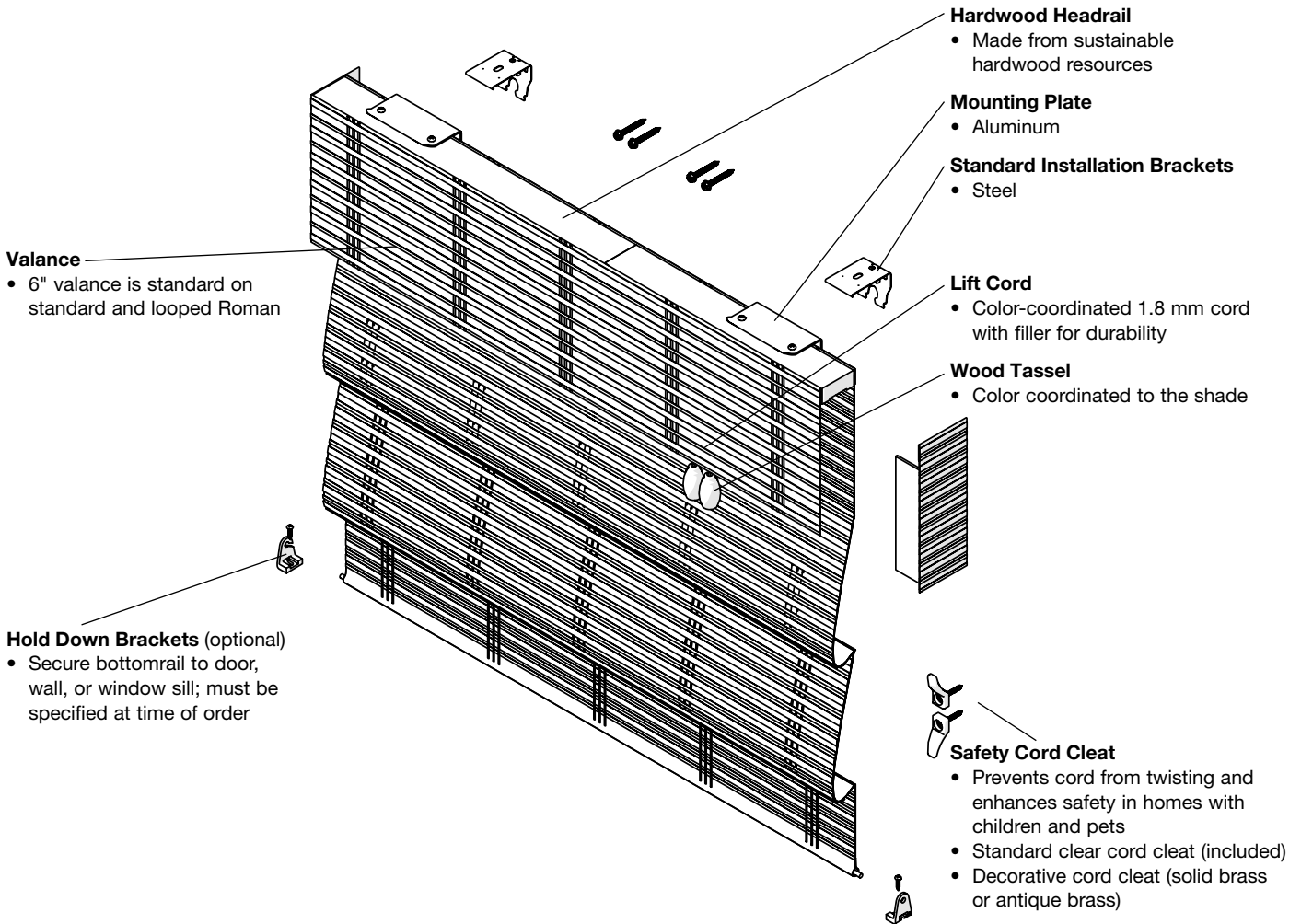

# General Information

## Natural Shades Cordless Lift Product Detail

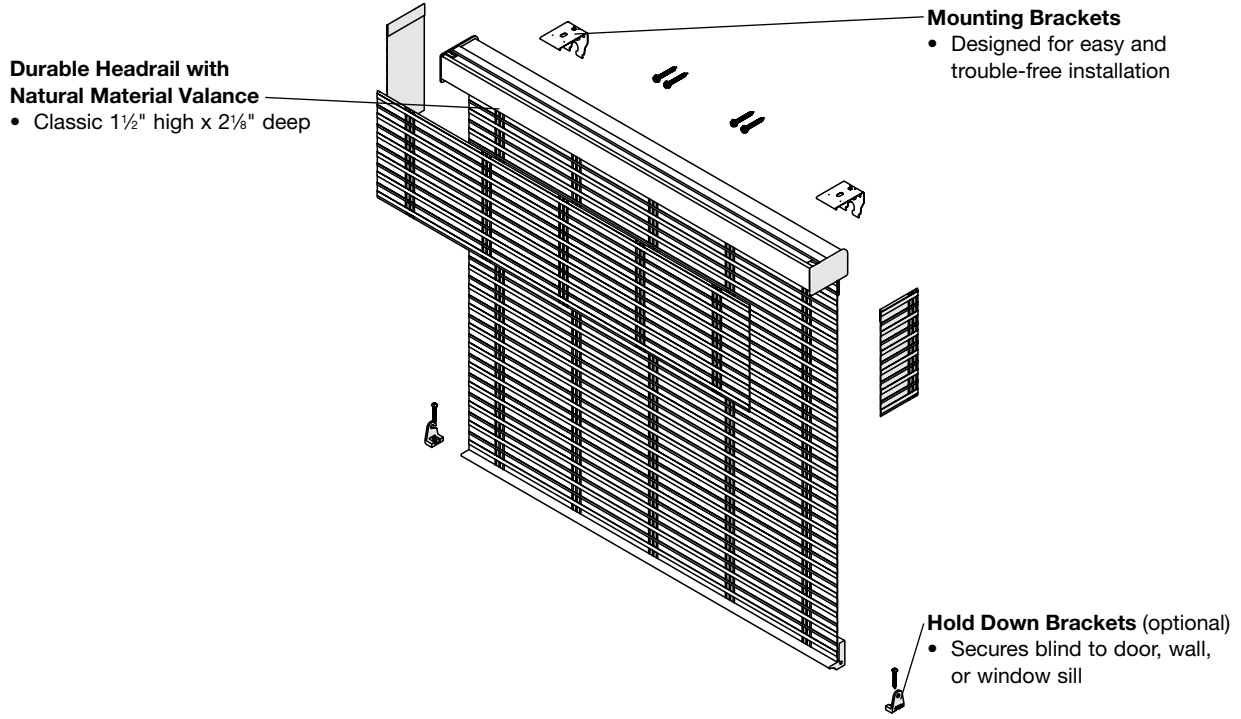

## Natural Shades Continuous-Loop Lift Product Detail

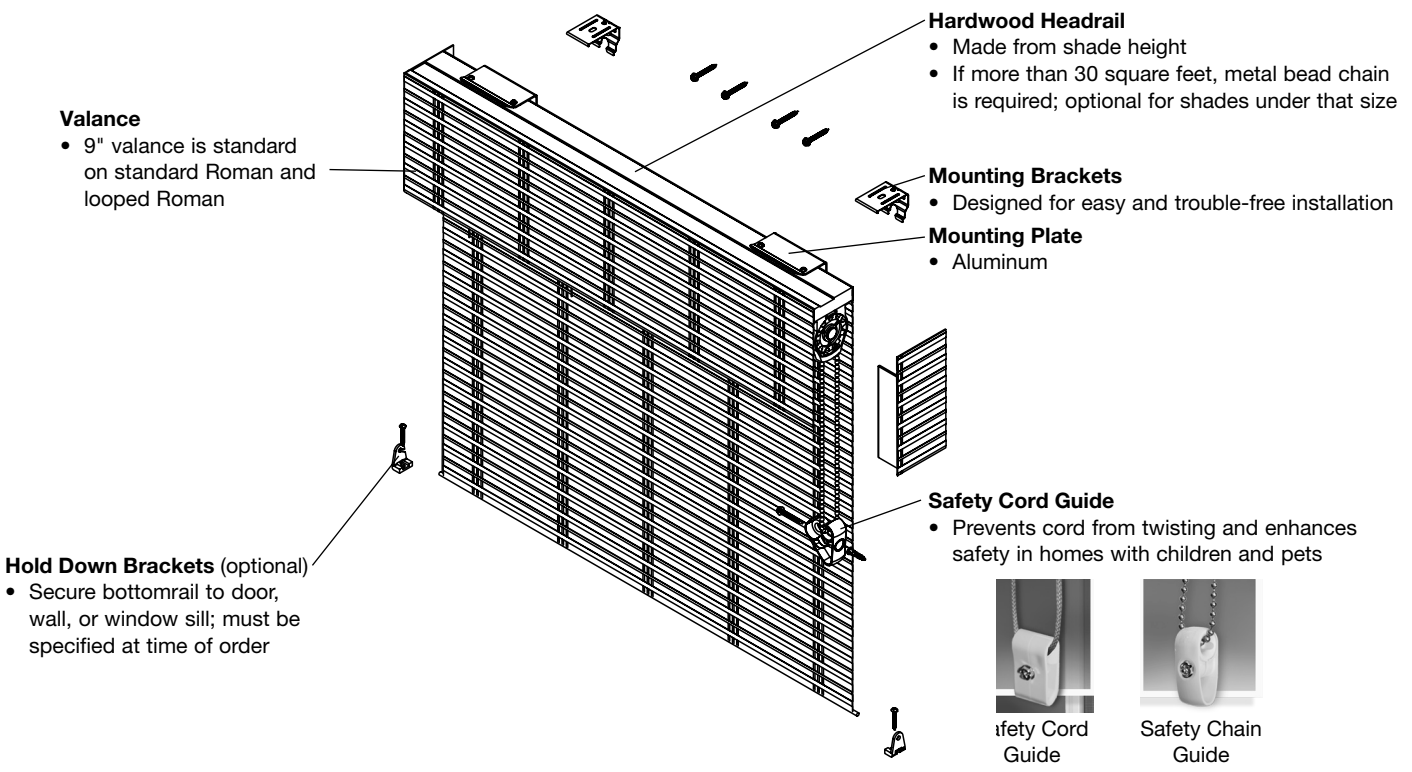

# General Information

## Natural Drapes Product Detail

### Wand Control

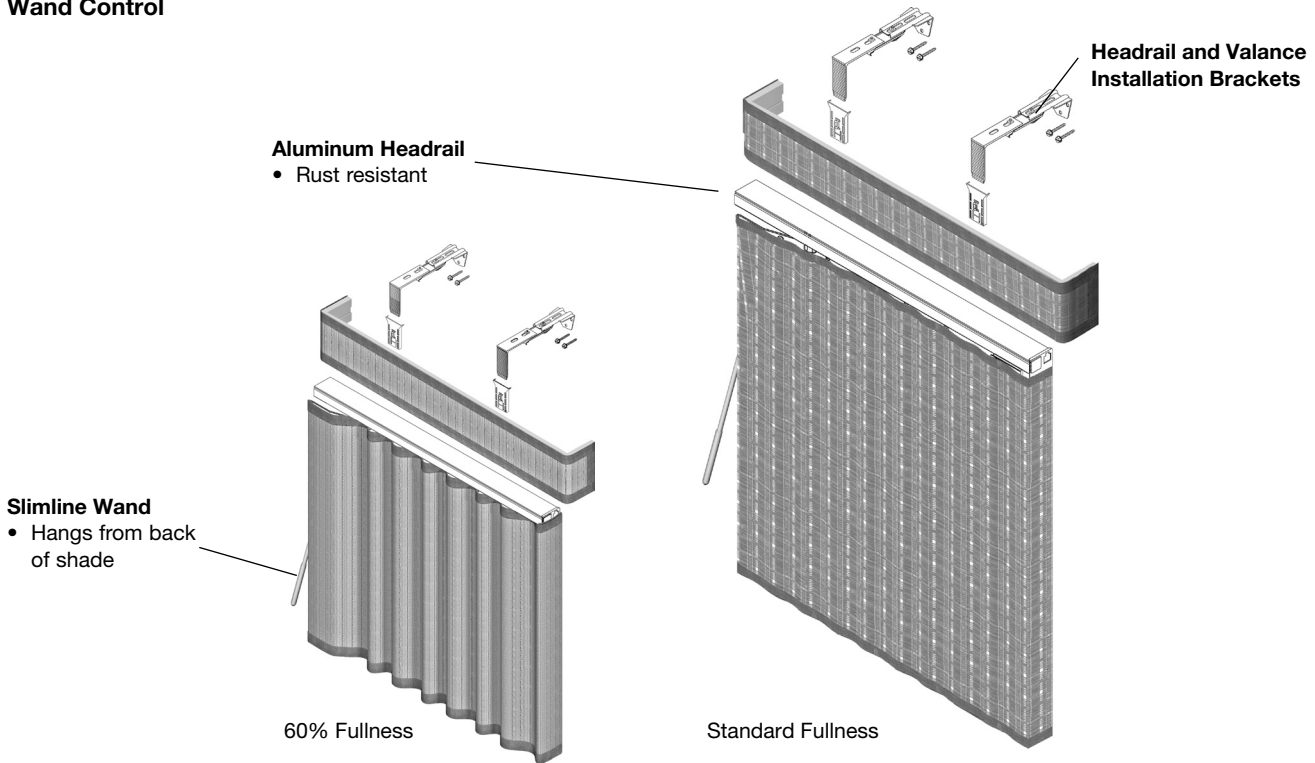

**NOTE:** Natural materials are vertically oriented on the natural drapes and valance.

### Cord Control

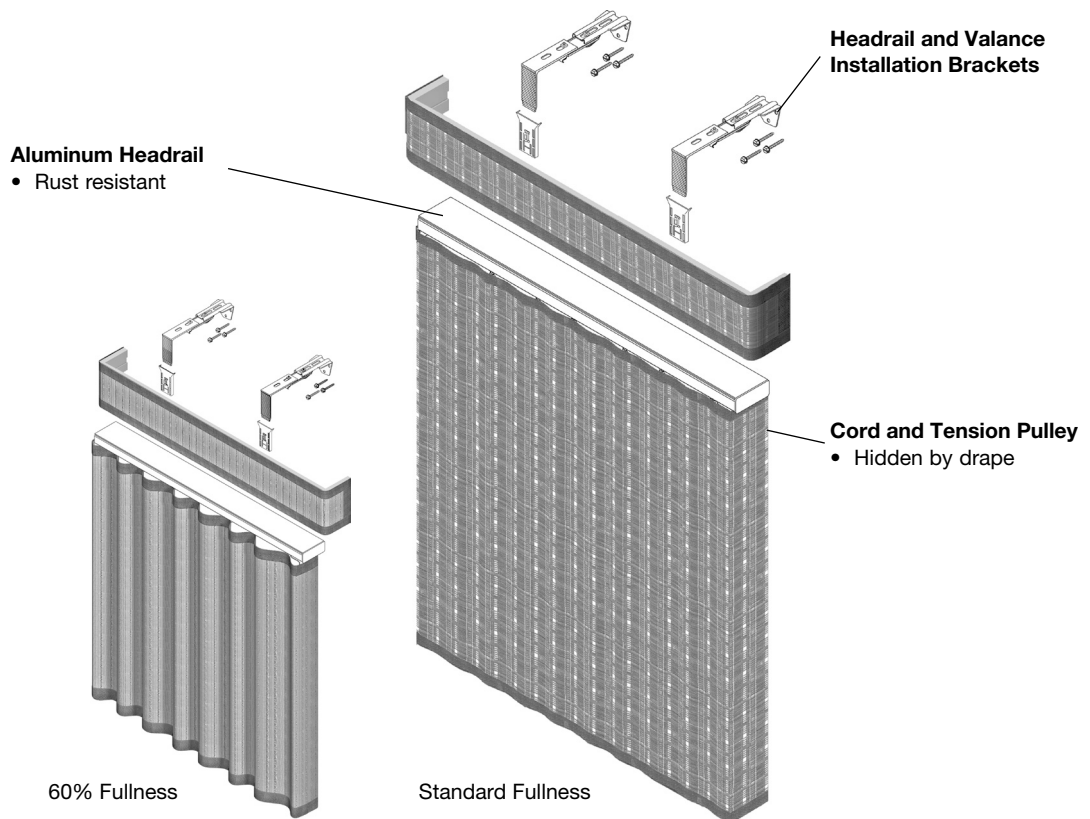

# Springs Window Fashions Limited Warranty

## WHAT IS COVERED

The product is warranted against original defects in materials or workmanship for the time period specified below, provided that the product was properly installed, the product was made or assembled exclusively from Springs Window Fashions' materials and components, and all Springs Window Fashions' recommendations were followed with regard to limitations and specifications. This warranty extends only to you as the original purchaser of the product.

### Limited Lifetime Warranty

- Cellular shades
- Roller shades
- Solar shades
- Roman shades
- Natural shades
- Pleated shades (with looped tape)
- Sheer shades
- Layered shades
- Wood blinds
- Faux wood blinds\*
- Composite blinds
- Wood shutters
- Composite shutters
- Sliding panels
- 1" and 2" aluminum horizontal blinds
- 2" vinyl horizontal blind headrails and components
- Vertical blind headrails, channel panels, and sheer fabric
- Painted and stained valances
- Painted and stained cornices
- Ladders and cloth tapes

\*Excludes Foundations faux wood blinds (see Five-Year Warranty)

## WHAT IS NOT COVERED

- Unfinished cornices, valances, or Palladian shelves
- Normal wear and tear, including:
  - Loss of color intensity, discoloration, fading, cracking, or yellowing caused by long exposure to direct sunlight
  - Slight color variation
  - Natural variations in color or grain of wood
  - Natural variations, cracking, splitting, twisting, bowing, shrinking, or stretching of organic material used in natural shades
  - Slight warpage of wood blinds or shutters; excessive warpage of wood blinds or shutters caused by moisture or high humidity
- Exterior solar shades damage caused by inclement weather, windy conditions, coastal/salt conditions, pressure washing, or exposure to chemicals including chlorine
- Shutters damage caused by improper maintenance, including sanding, improper washing, and use of razor blades or sealants
- Fabric damage caused by abuse, accidents, alterations, misuse, or failure to follow measuring/installation/use/cleaning/maintenance instructions

## WARRANTY OBLIGATIONS

The obligations of Springs Window Fashions are limited to the replacement or repair of parts or products found to be defective. If repairs are made under this warranty, the repairs will be made with like or similar parts. It is at the sole discretion of Springs Window Fashions to determine whether product will be replaced or repaired.

Springs Window Fashions is not responsible for shipping costs or labor costs, for measuring or taking the product down, or for remeasuring or reinstalling the product.

Springs Window Fashions may defer actions on any claim for warping for a period of up to twelve (12) months from the date of the claim in order to permit acclimating to humidity and temperature conditions.

Warranty coverage applies to defective product only. Other window coverings in the room/household will not be replaced.

THIS WARRANTY IS EXCLUSIVE AND IN LIEU OF ALL OTHER WRITTEN OR ORAL WARRANTIES OR OBLIGATIONS AND LIABILITIES. THE DURATION OF ANY IMPLIED WARRANTIES FOR ANY PRODUCT IS LIMITED IN DURATION TO THE WARRANTY TERM APPLICABLE TO SUCH PRODUCT AS SET FORTH ABOVE.

SPRINGS WINDOW FASHIONS SHALL HAVE NO LIABILITY WHATSOEVER FOR INCIDENTAL, PUNITIVE, OR CONSEQUENTIAL DAMAGES.

Some states do not allow the exclusion or limitation of incidental, punitive or consequential damages, so this limitation or exclusion may not apply to you.

No person is authorized to extend or alter this warranty.

### Five-Year Warranty

- Foundations faux wood blinds
- Motorized components and accessories (batteries not included)
- Exterior solar shades
- Draperies
- Fabric-covered cornices and valances
- Fabric-tailored shades and accessories

### Three-Year Warranty

- Operating cords
- Pleated shades (without looped tape)
- 2" vinyl horizontal blind slats
- Vertical blind vanes

## SERVICE

To learn more about warranty claims, contact customer service at 1-800-221-6352 or [windowfashions@springswindowfashions.com](mailto>windowfashions@springswindowfashions.com).

Warranty claims must be accompanied by the original sales receipt, along with details regarding the nature of the problem, location of the product, etc. Warranty claims may be submitted to the Customer Service Center at:

Customer Service Center  
Springs Window Fashions, LLC  
8467 Route 405 Highway South  
PO Box 500  
Montgomery, PA 17752-0500

# GRABER®

Graber is a brand of Springs Window Fashions, the Best Experience Company 

Graber and the Graber logo are registered trademarks of Springs Window Fashions, LLC.

(5/22) 22-297300

# GRABER.

## Grabers Tradewinds® Natural Shades and Drapes Designer US Price List — Effective January 2024

### Price Group A: Revelry

#### Standard Roman and Old Style Roman

Height up to inches (cm) ↓	Width up to inches (cm) →												
	22 (55.9)	26 (66.1)	30 (76.2)	36 (91.5)	42 (106.7)	48 (122)	60 (152.4)	72 (182.9)	84 (213.4)	96 (243.9)	108 (274.4)	120 (304.8)	144 (365.8)
34 (96)	258	278	307	353	373	397	481	560	681	805	857	908	1025
42 (106.7)	277	312	339	382	410	439	537	621	755	887	949	1016	1134
48 (122)	297	329	363	410	443	476	578	673	813	952	1025	1096	1240
54 (137.2)	314	351	382	439	476	515	617	727	879	1021	1104	1185	1349
60 (152.4)	339	367	409	471	504	545	660	779	932	1088	1174	1264	1435
66 (167.7)	353	391	433	497	540	585	709	833	996	1159	1254	1349	1544
72 (182.9)	373	411	457	523	571	617	752	887	1050	1217	1330	1429	1641
84 (213.4)	410	455	501	581	633	692	835	986	1172	1365	1482	1603	1840
96 (243.9)	449	497	554	640	700	762	930	1088	1290	1498	1633	1766	2039
108 (274.4)	493	544	612	675	762	849	999	1198	1402	1641	1782	1930	2226
120 (304.8)	533	592	662	735	826	934	1092	1309	1519	1779	1933	2099	2415

#### Add Surcharge to Shade Price

	125												
<b>Cordless Lift</b>													
<b>Privacy Liner</b>	73	89	107	119	131	149	176	220	250	275	308	346	412
<b>Room-Darkening Liner</b>	101	116	140	160	173	196	230	293	330	366	411	457	548
<b>Valance Liner</b>	18	21	28	30	34	37	44	53	58	62	73	81	97
<b>Premiere Valance</b>	42	46	51	53	58	65	81	89	98	113	125	144	167
<b>Deco-Trim Valance</b>	87	89	94	96	98	102	107	111	119	124	131	134	142

NOTE: Due to material width sizes, shades to the right of the heavy, solid line must be manufactured as multiple shades on one headrail.  
 NOTE: Multiple cordless lift shades available up to 144" wide (365.8cm), with same maximum height restrictions per panel as single-shade.  
 Single-shade cordless lift maximum height for Revelry indicated by dotted line. Cordless lift shades with liners have smaller size limits.  
 NOTE: Liners available on all specialty options, except deco-trim valances. Liners are 100% polyester.

#### Looped Roman

Height up to inches (cm) ↓	Width up to inches (cm) →												
	22 (55.9)	26 (66.1)	30 (76.2)	36 (91.5)	42 (106.7)	48 (122)	60 (152.4)	72 (182.9)	84 (213.4)	96 (243.9)	108 (274.4)	120 (304.8)	144 (365.8)
34 (96)	334	363	400	459	484	515	625	728	886	1048	1114	1180	1333
42 (106.7)	361	405	440	497	534	571	697	808	983	1153	1234	1319	1475
48 (122)	385	427	471	534	575	618	751	874	1057	1236	1333	1424	1612
54 (137.2)	408	456	497	571	618	670	802	946	1142	1328	1436	1541	1755
60 (152.4)	440	477	533	612	654	709	858	1012	1211	1414	1526	1643	1865
66 (167.7)	459	509	562	646	701	760	922	1083	1295	1507	1629	1755	2006
72 (182.9)	484	535	594	679	743	802	979	1153	1365	1583	1728	1857	2134
84 (213.4)	534	592	650	755	823	900	1087	1281	1523	1774	1927	2084	2391
96 (243.9)	584	646	720	831	911	992	1208	1414	1677	1947	2122	2297	2651
108 (274.4)	642	707	795	878	992	1103	1300	1556	1823	2134	2315	2510	2893
120 (304.8)	692	770	860	957	1073	1214	1419	1703	1975	2312	2514	2730	3140

#### Add Surcharge to Shade Price

<b>Privacy Liner</b>	88	99	116	129	139	158	185	228	257	281	319	354	420
<b>Room-Darkening Liner</b>	115	131	153	171	185	210	244	305	345	380	420	470	562
<b>Valance Liner</b>	18	21	28	30	34	37	44	53	58	62	73	81	97
<b>Premiere Valance</b>	42	46	51	53	58	65	81	89	98	113	125	144	167
<b>Deco-Trim Valance</b>	87	89	94	96	98	102	107	111	119	124	131	134	142

NOTE: Due to material width sizes, shades to the right of the solid line must be manufactured as multiple shades on one headrail.  
 NOTE: Liners available on all specialty options, except deco-trim valances. Liners are 100% polyester.

Revelry					
Dusk	80743	Dove	80745	Alabaster	80746
Moss	80747	Tahoe Brown	80749	Blue Ridge	81742
Muted Marine	81748				



## Price Group B: Bellamy, Lipo, Serenity

### Standard Roman and Old Style Roman

Height up to inches (cm) ↓	Width up to inches (cm) →												
	22 (55.9)	26 (66.1)	30 (76.2)	36 (91.5)	42 (106.7)	48 (122)	60 (152.4)	72 (182.9)	84 (213.4)	96 (243.9)	108 (274.4)	120 (304.8)	144 (365.8)
34 (96)	284	327	338	382	400	436	541	620	748	873	922	989	1191
42 (106.7)	306	341	363	421	457	504	581	679	814	971	1048	1117	1331
48 (122)	338	373	406	462	510	557	642	721	877	1049	1154	1232	1463
54 (137.2)	345	382	433	489	540	592	688	779	961	1115	1193	1313	1553
60 (152.4)	370	408	457	521	581	642	737	838	1014	1185	1266	1391	1644
66 (167.7)	384	433	482	557	609	672	789	902	1094	1254	1342	1477	1742
72 (182.9)	408	449	510	587	648	721	838	966	1128	1318	1422	1565	1838
84 (213.4)	446	489	558	648	729	801	942	1088	1258	1475	1615	1726	2015
96 (243.9)	489	539	606	712	792	880	1044	1200	1388	1615	1773	1901	2229
108 (274.4)	525	615	652	754	855	953	1132	1310	1730	1762	1922	2080	2458
120 (304.8)	568	665	702	802	917	1036	1221	1412	1746	1910	2074	2244	2683

### Add Surcharge to Shade Price

	125												
<b>Cordless Lift</b>	73	89	107	119	131	149	176	220	250	275	308	346	412
<b>Room-Darkening Liner</b>	101	116	140	160	173	196	230	293	330	366	411	457	548
<b>Valance Liner</b>	18	21	28	30	34	37	44	53	58	62	73	81	97
<b>Premiere Valance</b>	42	46	51	53	58	65	81	89	98	113	125	144	167
<b>Deco-Trim Valance</b>	87	89	94	96	98	102	107	111	119	124	131	134	142

NOTE: Due to material width sizes, shades to the right of the heavy, solid line must be manufactured as multiple shades on one headrail.

NOTE: Multiple cordless lift shades available up to 144" wide (365.8cm), with same maximum height restrictions per panel as single-shade.

Single-shade cordless lift maximum height for Lipo indicated by dotted line, Serenity by double-line, and Bellamy by thin solid line.

Cordless lift shades with liners have smaller size limits.

NOTE: Liners available on all specialty options, except deco-trim valances. Liners are 100% polyester.

### Looped Roman

Height up to inches (cm) ↓	Width up to inches (cm) →												
	22 (55.9)	26 (66.1)	30 (76.2)	36 (91.5)	42 (106.7)	48 (122)	60 (152.4)	72 (182.9)	84 (213.4)	96 (243.9)	108 (274.4)	120 (304.8)	144 (365.8)
34 (96)	370	425	439	497	519	567	703	806	971	1135	1199	1285	1549
42 (106.7)	399	443	471	547	594	654	755	883	1059	1263	1362	1451	1730
48 (122)	439	484	528	602	663	724	834	937	1139	1364	1500	1602	1901
54 (137.2)	449	497	562	637	701	770	894	1012	1249	1449	1550	1708	2019
60 (152.4)	481	530	594	678	755	834	958	1091	1317	1541	1646	1807	2138
66 (167.7)	501	562	626	724	791	873	1026	1173	1421	1629	1745	1921	2265
72 (182.9)	530	584	663	762	843	937	1091	1257	1467	1714	1849	2034	2389
84 (213.4)	580	637	725	843	948	1041	1226	1414	1635	1918	2099	2245	2619
96 (243.9)	637	700	787	925	1029	1143	1359	1559	1805	2099	2305	2472	2897
108 (274.4)	682	799	849	981	1110	1238	1472	1704	2250	2292	2498	2703	3194
120 (304.8)	739	864	914	1043	1193	1346	1586	1835	2270	2483	2698	2918	3489

### Add Surcharge to Shade Price

<b>Privacy Liner</b>	88	99	116	129	139	158	185	228	257	281	319	354	420
<b>Room-Darkening Liner</b>	115	131	153	171	185	210	244	305	345	380	420	470	562
<b>Valance Liner</b>	18	21	28	30	34	37	44	53	58	62	73	81	97
<b>Premiere Valance</b>	42	46	51	53	58	65	81	89	98	113	125	144	167
<b>Deco-Trim Valance</b>	87	89	94	96	98	102	107	111	119	124	131	134	142

NOTE: Due to material width sizes, shades to the right of the solid line must be manufactured as multiple shades on one headrail.

NOTE: Liners available on all specialty options, except deco-trim valances. Liners are 100% polyester.

Bellamy			
Rustic Weave	80820	Camel	80821

Lipo			
Ambrosia	06702	Earthtones	06793
		Natural	60706

Serenity	
Haze	11502

## Price Group C: Brooklyn, Denver, Inan, Kelton, Reminisce, Toushan II

### Standard Roman and Old Style Roman

Height up to inches (cm) ↓	Width up to inches (cm) →												
	22 (55.9)	26 (66.1)	30 (76.2)	36 (91.5)	42 (106.7)	48 (122)	60 (152.4)	72 (182.9)	84 (213.4)	96 (243.9)	108 (274.4)	120 (304.8)	144 (365.8)
34 (96)	313	366	373	444	479	524	613	699	823	961	1059	1180	1423
42 (106.7)	349	380	433	504	545	601	693	790	928	1068	1203	1331	1594
48 (122)	403	444	486	555	611	659	760	860	1016	1189	1331	1469	1746
54 (137.2)	413	461	511	588	644	709	823	932	1102	1281	1427	1569	1858
60 (152.4)	440	489	545	622	693	760	880	998	1189	1365	1514	1661	1963
66 (167.7)	467	511	574	659	729	809	949	1078	1263	1447	1602	1762	2083
72 (182.9)	489	538	611	701	774	860	998	1151	1347	1530	1699	1867	2194
84 (213.4)	534	588	666	771	865	958	1130	1294	1507	1707	1882	2062	2411
96 (243.9)	582	640	724	843	950	1046	1239	1438	1658	1874	2069	2267	2665
108 (274.4)	633	690	784	901	1018	1141	1353	1562	1902	2023	2247	2439	2934
120 (304.8)	683	737	837	959	1098	1233	1459	1686	1919	2173	2427	2611	3206

### Add Surcharge to Shade Price

	125												
<b>Cordless Lift</b>	73	89	107	119	131	149	176	220	250	275	308	346	412
<b>Privacy Liner</b>	101	116	140	160	173	196	230	293	330	366	411	457	548
<b>Room-Darkening Liner</b>	18	21	28	30	34	37	44	53	58	62	73	81	97
<b>Valance Liner</b>	42	46	51	53	58	65	81	89	98	113	125	144	167
<b>Premiere Valance</b>	87	89	94	96	98	102	107	111	119	124	131	134	142
<b>Deco-Trim Valance</b>													

NOTE: Due to material width sizes, shades to the right of the heavy, solid line must be manufactured as multiple shades on one headrail.

NOTE: Multiple cordless lift shades available up to 144" wide (365.8cm), with same maximum height restrictions per panel as single-shade.

Single-shade cordless lift maximum height for Toushan II and Inan indicated by dotted line, Kelton by thin solid line, all others by double-line.

Cordless lift shades with liners have smaller size limits.

NOTE: Liners available on all specialty options, except deco-trim valances. Liners are 100% polyester.

### Looped Roman

Height up to inches (cm) ↓	Width up to inches (cm) →												
	22 (55.9)	26 (66.1)	30 (76.2)	36 (91.5)	42 (106.7)	48 (122)	60 (152.4)	72 (182.9)	84 (213.4)	96 (243.9)	108 (274.4)	120 (304.8)	144 (365.8)
34 (96)	406	476	486	576	623	681	795	908	1069	1249	1376	1531	1851
42 (106.7)	454	494	564	655	710	782	901	1028	1205	1388	1564	1731	2072
48 (122)	524	576	633	722	793	857	987	1118	1321	1546	1731	1910	2271
54 (137.2)	537	600	664	765	837	922	1069	1211	1433	1664	1854	2039	2414
60 (152.4)	572	636	710	809	901	987	1146	1297	1546	1774	1968	2159	2553
66 (167.7)	606	664	747	857	948	1052	1233	1401	1642	1882	2083	2291	2706
72 (182.9)	636	699	793	911	1006	1118	1297	1496	1751	1990	2210	2427	2851
84 (213.4)	693	765	867	1004	1123	1245	1470	1683	1959	2219	2447	2680	3134
96 (243.9)	756	831	940	1096	1234	1360	1612	1868	2156	2436	2691	2948	3464
108 (274.4)	823	897	1018	1171	1325	1482	1759	2029	2472	2629	2922	3169	3816
120 (304.8)	889	959	1088	1247	1428	1603	1897	2191	2495	2825	3156	3394	4168

### Add Surcharge to Shade Price

	125												
<b>Privacy Liner</b>	88	99	116	129	139	158	185	228	257	281	319	354	420
<b>Room-Darkening Liner</b>	115	131	153	171	185	210	244	305	345	380	420	470	562
<b>Valance Liner</b>	18	21	28	30	34	37	44	53	58	62	73	81	97
<b>Premiere Valance</b>	42	46	51	53	58	65	81	89	98	113	125	144	167
<b>Deco-Trim Valance</b>	87	89	94	96	98	102	107	111	119	124	131	134	142

NOTE: Due to material width sizes, shades to the right of the solid line must be manufactured as multiple shades on one headrail.

NOTE: Liners available on all specialty options, except deco-trim valances. Liners are 100% polyester.

<b>Brooklyn</b>													
Weathered Beige	15870		Swan			15871							
<b>Denver</b>													
Flax Seed	55750		Sweet Cream		55751		Foggy Blue Ridge		55752				
<b>Inan</b>													
Umber	04858												
<b>Kelton</b>													
True White	25890		Ivory		25891		Jet Black		25892				
Soft Coal	25893												
<b>Reminisce</b>													
Faded Slate	32360		Faded Star White		32361		Fossil Gray		32363				
<b>Toushan II</b>													
Taupe	63659												

## Price Group D: Moniz, Sarto, Stateside

### Standard Roman and Old Style Roman

Height up to inches (cm) ↓	Width up to inches (cm) →												
	22 (55.9)	26 (66.1)	30 (76.2)	36 (91.5)	42 (106.7)	48 (122)	60 (152.4)	72 (182.9)	84 (213.4)	96 (243.9)	108 (274.4)	120 (304.8)	144 (365.8)
34 (96)	377	418	453	518	555	582	709	829	1008	1187	1269	1346	1512
42 (106.7)	411	460	498	569	603	653	790	920	1116	1305	1403	1491	1674
48 (122)	434	483	533	603	654	704	850	994	1205	1406	1514	1622	1831
54 (137.2)	466	513	569	653	704	760	913	1073	1295	1509	1631	1753	1993
60 (152.4)	501	552	600	698	748	809	976	1154	1381	1603	1738	1867	2123
66 (167.7)	518	578	640	734	801	866	1042	1229	1468	1714	1856	1993	2282
72 (182.9)	555	604	679	770	843	913	1110	1305	1557	1802	1960	2113	2424
84 (213.4)	603	674	741	856	935	1028	1236	1456	1732	2016	2191	2366	2718
96 (243.9)	663	734	814	939	1035	1125	1371	1603	1905	2218	2412	2613	3010
108 (274.4)	724	808	899	1000	1125	1253	1481	1773	2071	2424	2632	2853	3291
120 (304.8)	788	876	981	1087	1217	1382	1615	1939	2242	2629	2861	3099	3569

### Add Surcharge to Shade Price

	125												
<b>Cordless Lift</b>	73	89	107	119	131	149	176	220	250	275	308	346	412
<b>Privacy Liner</b>	101	116	140	160	173	196	230	293	330	366	411	457	548
<b>Room-Darkening Liner</b>	18	21	28	30	34	37	44	53	58	62	73	81	97
<b>Valance Liner</b>	42	46	51	53	58	65	81	89	98	113	125	144	167
<b>Premiere Valance</b>	87	89	94	96	98	102	107	111	119	124	131	134	142
<b>Deco-Trim Valance</b>													

NOTE: Due to material width sizes, shades to the right of the heavy, solid line must be manufactured as multiple shades on one headrail.  
 NOTE: Multiple cordless lift shades available up to 144" wide (365.8cm), with same maximum height restrictions per panel as single-shade.  
 Single-shade cordless lift maximum height for Moniz indicated by dotted line, Stateside by double-line, Sarto by thin solid line.  
 Cordless lift shades with liners have smaller size limits.  
 NOTE: Liners available on all specialty options, except deco-trim valances. Liners are 100% polyester.

### Looped Roman

Height up to inches (cm) ↓	Width up to inches (cm) →												
	22 (55.9)	26 (66.1)	30 (76.2)	36 (91.5)	42 (106.7)	48 (122)	60 (152.4)	72 (182.9)	84 (213.4)	96 (243.9)	108 (274.4)	120 (304.8)	144 (365.8)
34 (96)	492	542	588	675	722	756	922	1078	1311	1544	1650	1750	1966
42 (106.7)	535	599	647	739	785	849	1028	1194	1449	1696	1824	1940	2175
48 (122)	565	628	692	785	850	915	1105	1292	1566	1829	1968	2107	2380
54 (137.2)	604	668	739	849	915	987	1188	1395	1684	1961	2120	2278	2592
60 (152.4)	651	717	781	907	972	1052	1268	1501	1796	2085	2260	2427	2760
66 (167.7)	675	751	831	955	1042	1125	1355	1598	1909	2228	2413	2592	2968
72 (182.9)	722	786	881	1003	1096	1188	1443	1696	2024	2343	2549	2746	3152
84 (213.4)	785	874	962	1113	1215	1335	1608	1892	2251	2621	2847	3075	3534
96 (243.9)	863	955	1058	1222	1344	1463	1780	2085	2476	2882	3135	3397	3914
108 (274.4)	940	1049	1169	1298	1463	1628	1924	2305	2693	3152	3421	3710	4279
120 (304.8)	1023	1141	1275	1413	1583	1798	2100	2520	2915	3418	3719	4029	4640

### Add Surcharge to Shade Price

	125												
<b>Privacy Liner</b>	88	99	116	129	139	158	185	228	257	281	319	354	420
<b>Room-Darkening Liner</b>	115	131	153	171	185	210	244	305	345	380	420	470	562
<b>Valance Liner</b>	18	21	28	30	34	37	44	53	58	62	73	81	97
<b>Premiere Valance</b>	42	46	51	53	58	65	81	89	98	113	125	144	167
<b>Deco-Trim Valance</b>	87	89	94	96	98	102	107	111	119	124	131	134	142

NOTE: Due to material width sizes, shades to the right of the solid line must be manufactured as multiple shades on one headrail.  
 NOTE: Liners available on all specialty options, except deco-trim valances. Liners are 100% polyester.

Moniz					
Finland	05080	Peru	05081	Austria	05083
Belgium	05084				

Sarto			
Fawn	75800	Burlap	75810

Stateside					
Tiki	85830	Fossil Gray	85831	Admiral Navy	85832
Faded Star White	85833				

**Price Group E: Beachfront, Boardwalk, Hadley, Merino, Saterra, Selene, Terrestrial, Verity, Wild Haven, Zishan**

**Standard Roman and Old Style Roman**

Height up to inches (cm) ↓	Width up to inches (cm) →												
	22 (55.9)	26 (66.1)	30 (76.2)	36 (91.5)	42 (106.7)	48 (122)	60 (152.4)	72 (182.9)	84 (213.4)	96 (243.9)	108 (274.4)	120 (304.8)	144 (365.8)
34 (96)	444	482	528	604	645	684	827	960	1173	1385	1475	1567	1752
42 (106.7)	479	531	581	658	710	756	923	1069	1299	1526	1632	1745	1959
48 (122)	514	564	624	710	758	822	993	1165	1399	1638	1766	1886	2131
54 (137.2)	543	599	658	756	822	880	1068	1251	1508	1752	1896	2036	2319
60 (152.4)	580	641	706	807	877	944	1131	1342	1603	1874	2024	2171	2478
66 (167.7)	608	671	743	854	931	1003	1212	1427	1707	1994	2158	2321	2655
72 (182.9)	645	710	785	897	981	1068	1294	1521	1815	2102	2283	2463	2818
84 (213.4)	709	781	866	995	1096	1190	1441	1695	2018	2343	2550	2753	3160
96 (243.9)	774	854	953	1099	1204	1307	1595	1874	2223	2571	2805	3031	3493
108 (274.4)	844	934	1019	1189	1310	1413	1751	2048	2428	2812	3064	3316	3816
120 (304.8)	908	1010	1123	1299	1413	1526	1898	2225	2637	3053	3325	3598	4136

**Add Surcharge to Shade Price**

	125												
<b>Cordless Lift</b>													
<b>Privacy Liner</b>	73	89	107	119	131	149	176	220	250	275	308	346	412
<b>Room-Darkening Liner</b>	101	116	140	160	173	196	230	293	330	366	411	457	548
<b>Valance Liner</b>	18	21	28	30	34	37	44	53	58	62	73	81	97
<b>Premiere Valance</b>	42	46	51	53	58	65	81	89	98	113	125	144	167
<b>Deco-Trim Valance</b>	87	89	94	96	98	102	107	111	119	124	131	134	142

**NOTE:** Due to material width sizes, shades to the right of the heavy, solid line must be manufactured as multiple shades on one headrail.  
**NOTE:** Multiple cordless lift shades available up to 144" wide (365.8cm), with same maximum height restrictions per panel as single-shade.  
 Single-shade cordless lift maximum height indicated by dotted line. Cordless lift shades with liners have smaller size limits.  
**NOTE:** Liners available on all specialty options, except deco-trim valances. Liners are 100% polyester.

**Looped Roman**

Height up to inches (cm) ↓	Width up to inches (cm) →												
	22 (55.9)	26 (66.1)	30 (76.2)	36 (91.5)	42 (106.7)	48 (122)	60 (152.4)	72 (182.9)	84 (213.4)	96 (243.9)	108 (274.4)	120 (304.8)	144 (365.8)
34 (96)	576	627	684	786	838	890	1076	1248	1524	1802	1917	2036	2277
42 (106.7)	623	688	755	856	923	983	1200	1390	1690	1985	2121	2268	2547
48 (122)	669	732	813	923	984	1068	1291	1516	1818	2131	2296	2452	2769
54 (137.2)	707	780	856	983	1068	1146	1388	1627	1960	2277	2465	2648	3016
60 (152.4)	754	833	917	1048	1142	1228	1472	1745	2085	2436	2632	2822	3222
66 (167.7)	790	872	965	1110	1210	1302	1575	1854	2219	2593	2805	3017	3452
72 (182.9)	838	923	1019	1165	1275	1388	1683	1978	2359	2732	2969	3202	3664
84 (213.4)	922	1014	1125	1293	1425	1547	1874	2203	2622	3045	3314	3578	4108
96 (243.9)	1006	1110	1238	1430	1565	1699	2074	2436	2890	3344	3646	3939	4541
108 (274.4)	1097	1214	1326	1546	1703	1837	2276	2662	3158	3656	3983	4311	4961
120 (304.8)	1181	1312	1459	1690	1837	1985	2467	2892	3428	3967	4323	4676	5376

**Add Surcharge to Shade Price**

<b>Privacy Liner</b>	88	99	116	129	139	158	185	228	257	281	319	354	420
<b>Room-Darkening Liner</b>	115	131	153	171	185	210	244	305	345	380	420	470	562
<b>Valance Liner</b>	18	21	28	30	34	37	44	53	58	62	73	81	97
<b>Premiere Valance</b>	42	46	51	53	58	65	81	89	98	113	125	144	167
<b>Deco-Trim Valance</b>	87	89	94	96	98	102	107	111	119	124	131	134	142

**NOTE:** Due to material width sizes, shades to the right of the solid line must be manufactured as multiple shades on one headrail.  
**NOTE:** Liners available on all specialty options, except deco-trim valances. Liners are 100% polyester.

<b>Beachfront</b>					
Tidepool	60040	Surf	60041	Thatch	60042
<b>Boardwalk</b>					
Pier	15968	Light Fossil Gray	15961	Saddlery	15962
<b>Hadley</b>					
Ivory Elegance	35910	Silver Mist	35911		
<b>Merino</b>					
Grenada	55507	Faded Star White	50510	Stardust	50511
<b>Saterra</b>					
Azure	03269	Terrain	03370	Surf	03374
<b>Selene</b>					
Oatmeal	30900	Sophisticated Slate	30901	Vanilla Cream	30902
<b>Terrestrial</b>					
Alpaca	28001	Camel	28003		
<b>Verity</b>					
Gentee Gray	46460	Suitcoat	46461	Warm Wicker	46462
<b>Wild Haven</b>					
Faded Star White	47465	Light Fossil Gray	47466	Porch Swing	47467
Sandpiper	47468				
<b>Zishan</b>					
Hut	30736	Stardust	43731		

**Price Group F: Cameron, Oxford, Paralian, Purcell, Rowen, Seasons, Tatum, Ventura**

**Standard Roman and Old Style Roman**

Height up to inches (cm) ↓	Width up to inches (cm) →												
	22 (55.9)	26 (66.1)	30 (76.2)	36 (91.5)	42 (106.7)	48 (122)	60 (152.4)	72 (182.9)	84 (213.4)	96 (243.9)	108 (274.4)	120 (304.8)	144 (365.8)
34 (96)	505	569	614	703	747	794	961	1114	1357	1603	1711	1827	2047
42 (106.7)	562	619	672	762	826	880	1069	1237	1509	1771	1898	2023	2270
48 (122)	592	655	719	826	880	952	1149	1350	1626	1902	2051	2191	2483
54 (137.2)	627	698	762	880	952	1022	1236	1451	1749	2038	2203	2364	2699
60 (152.4)	672	735	823	932	1022	1095	1312	1557	1862	2174	2348	2527	2877
66 (167.7)	707	781	862	994	1084	1161	1408	1654	1983	2315	2506	2689	3067
72 (182.9)	742	829	908	1046	1137	1236	1502	1771	2109	2441	2648	2857	3267
84 (213.4)	826	907	1002	1154	1269	1382	1678	1975	2339	2722	2958	3196	3669
96 (243.9)	903	994	1109	1276	1397	1515	1851	2174	2583	2989	3260	3525	4053
108 (274.4)	987	1084	1197	1369	1511	1649	2009	2385	2826	3264	3563	3852	4431
120 (304.8)	1074	1161	1282	1456	1636	1779	2174	2601	3065	3549	3869	4181	4819

**Add Surcharge to Shade Price**

	125												
<b>Cordless Lift</b>													
<b>Privacy Liner</b>	73	89	107	119	131	149	176	220	250	275	308	346	412
<b>Room-Darkening Liner</b>	101	116	140	160	173	196	230	293	330	366	411	457	548
<b>Valance Liner</b>	18	21	28	30	34	37	44	53	58	62	73	81	97
<b>Premiere Valance</b>	42	46	51	53	58	65	81	89	98	113	125	144	167
<b>Deco-Trim Valance</b>	87	89	94	96	98	102	107	111	119	124	131	134	142

NOTE: Due to material width sizes, shades to the right of the heavy, solid line must be manufactured as multiple shades on one headrail.  
 NOTE: Multiple cordless lift shades available up to 144" wide (365.8cm), with same maximum height restrictions per panel as single-shade.  
 Single-shade cordless lift maximum height indicated by dotted line. Cordless lift shades with liners have smaller size limits.  
 NOTE: Liners available on all specialty options, except deco-trim valances. Liners are 100% polyester.

**Looped Roman**

Height up to inches (cm) ↓	Width up to inches (cm) →												
	22 (55.9)	26 (66.1)	30 (76.2)	36 (91.5)	42 (106.7)	48 (122)	60 (152.4)	72 (182.9)	84 (213.4)	96 (243.9)	108 (274.4)	120 (304.8)	144 (365.8)
34 (96)	655	740	798	915	970	1032	1249	1448	1763	2084	2224	2376	2660
42 (106.7)	731	804	873	992	1073	1143	1389	1609	1962	2302	2468	2629	2951
48 (122)	770	853	934	1073	1143	1236	1495	1756	2114	2473	2666	2848	3228
54 (137.2)	816	908	992	1143	1236	1329	1607	1887	2274	2650	2864	3074	3508
60 (152.4)	873	957	1069	1211	1329	1423	1707	2025	2419	2827	3053	3286	3741
66 (167.7)	919	1016	1122	1292	1410	1509	1829	2150	2577	3011	3258	3497	3987
72 (182.9)	964	1077	1180	1361	1479	1607	1953	2302	2742	3174	3443	3714	4248
84 (213.4)	1073	1179	1304	1500	1651	1796	2181	2567	3042	3538	3847	4155	4770
96 (243.9)	1174	1292	1443	1658	1816	1969	2406	2827	3359	3885	4237	4581	5269
108 (274.4)	1282	1410	1555	1779	1964	2143	2612	3101	3673	4243	4632	5008	5761
120 (304.8)	1397	1509	1667	1894	2126	2312	2827	3380	3986	4613	5031	5435	6265

**Add Surcharge to Shade Price**

	125												
<b>Privacy Liner</b>	88	99	116	129	139	158	185	228	257	281	319	354	420
<b>Room-Darkening Liner</b>	115	131	153	171	185	210	244	305	345	380	420	470	562
<b>Valance Liner</b>	18	21	28	30	34	37	44	53	58	62	73	81	97
<b>Premiere Valance</b>	42	46	51	53	58	65	81	89	98	113	125	144	167
<b>Deco-Trim Valance</b>	87	89	94	96	98	102	107	111	119	124	131	134	142

NOTE: Due to material width sizes, shades to the right of the solid line must be manufactured as multiple shades on one headrail.  
 NOTE: Liners available on all specialty options, except deco-trim valances. Liners are 100% polyester.

<b>Cameron</b>					
Whole Wheat	65780	Cloud	65781	Fairweather Blue	65782
Khaki Canvas	65783				

<b>Oxford</b>					
Tender Taupe	45740	French Roast	45741	Crisp Cotton	45742
Ebony	45743				

<b>Paralian</b>					
Mink	25050	Otter	25052		

<b>Purcell</b>					
Sunbleached Sand	40730	Golden Grain	40731		

<b>Rowen</b>					
Thundercloud	60770	Toasted Tan	60771		

<b>Seasons</b>					
Blue Ridge	33386	Faded Star White	33387	Sandpiper	33388
Sedona Sands	33389				

<b>Tatum</b>					
Warm Wicker	70790				

<b>Ventura</b>					
Lake Blue	20880	Cabin Fever	20881	Marshmallow	20883



## Price Group G: Bayport, Berwick, Cherish, Interlude, Olympia

### Standard Roman and Old Style Roman

Height up to inches (cm) ↓	Width up to inches (cm) →												
	22 (55.9)	26 (66.1)	30 (76.2)	36 (91.5)	42 (106.7)	48 (122)	60 (152.4)	72 (182.9)	84 (213.4)	96 (243.9)	108 (274.4)	120 (304.8)	144 (365.8)
34 (96)	606	682	737	845	895	953	1153	1337	1627	1923	2053	2193	2457
42 (106.7)	675	744	805	915	991	1055	1283	1484	1812	2125	2277	2428	2724
48 (122)	712	786	862	991	1055	1142	1380	1621	1952	2282	2461	2629	2980
54 (137.2)	753	837	915	1055	1142	1227	1483	1742	2099	2446	2644	2837	3238
60 (152.4)	805	883	988	1119	1227	1313	1575	1869	2234	2609	2817	3032	3453
66 (167.7)	849	937	1035	1194	1301	1394	1689	1985	2379	2779	3007	3228	3680
72 (182.9)	889	995	1091	1256	1365	1483	1801	2125	2532	2929	3178	3428	3920
84 (213.4)	991	1089	1203	1384	1523	1658	2013	2369	2808	3266	3550	3836	4402
96 (243.9)	1084	1184	1332	1531	1677	1818	2222	2609	3100	3586	3912	4229	4865
108 (274.4)	1183	1301	1436	1643	1814	1979	2410	2862	3392	3916	4276	4623	5318
120 (304.8)	1290	1394	1538	1748	1962	2135	2609	3122	3678	4259	4642	5017	5783

### Add Surcharge to Shade Price

	Cordless Lift												
	125												
Privacy Liner	73	89	107	119	131	149	176	220	250	275	308	346	412
Room-Darkening Liner	101	116	140	160	173	196	230	293	330	366	411	457	548
Valance Liner	18	21	28	30	34	37	44	53	58	62	73	81	97
Premiere Valance	42	46	51	53	58	65	81	89	98	113	125	144	167
Deco-Trim Valance	87	89	94	96	98	102	107	111	119	124	131	134	142

NOTE: Due to material width sizes, shades to the right of the heavy, solid line must be manufactured as multiple shades on one headrail.  
 NOTE: Multiple cordless lift shades available up to 144" wide (365.8cm), with same maximum height restrictions per panel as single-shade.  
 Single-shade cordless lift maximum height indicated by dotted line. Cordless lift shades with liners have smaller size limits.  
 NOTE: Liners available on all specialty options, except deco-trim valances. Liners are 100% polyester.

### Looped Roman

Height up to inches (cm) ↓	Width up to inches (cm) →												
	22 (55.9)	26 (66.1)	30 (76.2)	36 (91.5)	42 (106.7)	48 (122)	60 (152.4)	72 (182.9)	84 (213.4)	96 (243.9)	108 (274.4)	120 (304.8)	144 (365.8)
34 (96)	787	887	958	1097	1164	1238	1499	1738	2116	2500	2669	2850	3193
42 (106.7)	878	966	1048	1189	1289	1372	1668	1930	2355	2762	2961	3156	3541
48 (122)	925	1022	1122	1289	1372	1484	1793	2107	2538	2967	3198	3418	3875
54 (137.2)	980	1090	1189	1372	1484	1595	1929	2265	2730	3181	3436	3687	4210
60 (152.4)	1048	1147	1284	1453	1595	1708	2047	2431	2905	3393	3663	3942	4489
66 (167.7)	1103	1220	1345	1551	1690	1812	2196	2580	3092	3612	3909	4196	4785
72 (182.9)	1156	1294	1417	1633	1774	1929	2342	2762	3291	3809	4130	4456	5096
84 (213.4)	1289	1415	1564	1799	1981	2155	2617	3081	3649	4247	4614	4986	5724
96 (243.9)	1410	1551	1731	1990	2179	2363	2888	3393	4029	4662	5086	5497	6323
108 (274.4)	1539	1690	1866	2136	2358	2572	3133	3721	4409	5091	5558	6009	6912
120 (304.8)	1677	1812	2000	2273	2551	2776	3393	4058	4782	5537	6035	6523	7519

### Add Surcharge to Shade Price

Privacy Liner	88	99	116	129	139	158	185	228	257	281	319	354	420
Room-Darkening Liner	115	131	153	171	185	210	244	305	345	380	420	470	562
Valance Liner	18	21	28	30	34	37	44	53	58	62	73	81	97
Premiere Valance	42	46	51	53	58	65	81	89	98	113	125	144	167
Deco-Trim Valance	87	89	94	96	98	102	107	111	119	124	131	134	142

NOTE: Due to material width sizes, shades to the right of the solid line must be manufactured as multiple shades on one headrail.  
 NOTE: Liners available on all specialty options, except deco-trim valances. Liners are 100% polyester.

<b>Bayport</b>	
Sand Dune	23190
<b>Berwick</b>	
Sand Wood	43195
<b>Cherish</b>	
Natural Sparkle	53205
<b>Interlude</b>	
Blue Ridge	83320
Sand Cream	83323
	Dusky Lilac
	83321
	Ivory Tusk
	83322
<b>Olympia</b>	
Natural White	38345

**Price Group H: Revelry**  
**Standard Drapery Fullness**

Height up to inches (cm) ↓	Width up to inches (cm) →													
	48 (122)	60 (152.4)	72 (182.9)	78 (198.2)	84 (213.4)	96 (243.9)	108 (274.4)	120 (304.8)	132 (335.3)	144 (365.8)	156 (396.3)	168 (426.8)	180 (457.2)	192 (487.7)
36 (96)	563	660	734	805	927	945	1028	1282	1366	1426	1500	1584	1691	1708
48 (122)	618	733	828	904	1043	1062	1172	1430	1537	1614	1689	1785	1920	1932
60 (152.4)	692	808	920	1002	1161	1179	1308	1586	1708	1798	1870	1986	2152	2164
72 (182.9)	727	886	1002	1104	1275	1297	1450	1738	1884	1980	2057	2193	2376	2392
84 (213.4)	787	958	1097	1217	1395	1408	1586	1852	2055	2161	2246	2392	2605	2623
96 (243.9)	834	1028	1188	1308	1505	1525	1680	2046	2225	2351	2433	2598	2837	2847

**Add Surcharge to Shade Price**

Privacy Liner	204	208	220	220	220	226	231	239	241	243	250	255	264	268
Room-Darkening Liner	264	268	285	285	285	291	298	303	310	322	325	333	340	348

NOTE: Price includes premiere valance. Must provide desired valance options.

**60% Drapery Fullness**

Height up to inches (cm) ↓	Width up to inches (cm) →													
	48 (122)	60 (152.4)	72 (182.9)	78 (198.2)	84 (213.4)	96 (243.9)	108 (274.4)	120 (304.8)	132 (335.3)	144 (365.8)	156 (396.3)	168 (426.8)	180 (457.2)	192 (487.7)
36 (96)	858	1009	1123	1229	1415	1441	1570	1956	2086	2176	2289	2418	2580	2604
48 (122)	943	1122	1263	1378	1592	1621	1787	2182	2348	2463	2575	2725	2927	2952
60 (152.4)	1056	1232	1401	1529	1775	1801	1999	2422	2604	2746	2855	3033	3280	3305
72 (182.9)	1109	1350	1529	1689	1947	1980	2215	2651	2873	3020	3138	3345	3627	3651
84 (213.4)	1198	1458	1676	1862	2132	2151	2422	2824	3133	3300	3427	3651	3979	4006
96 (243.9)	1273	1570	1813	1999	2297	2329	2566	3124	3394	3585	3714	3962	4331	4348

**Add Surcharge to Shade Price**

Privacy Liner	325	333	351	351	351	361	372	382	386	390	399	409	418	427
Room-Darkening Liner	418	427	458	458	458	467	474	483	504	513	520	531	544	557

NOTE: Price includes premiere valance. Must provide desired valance options.

Revelry					
Dove	80745	Dusk	80743	Alabaster	80746
Moss	80747	Tahoe Brown	80749	Blue Ridge	81742
Muted Marine	81748				

## Price Group I: Bellamy, Lipo, Serenity

### Standard Drapery Fullness

Height up to inches (cm) ↓	Width up to inches (cm) →													
	48 (122)	60 (152.4)	72 (182.9)	78 (198.2)	84 (213.4)	96 (243.9)	108 (274.4)	120 (304.8)	132 (335.3)	144 (365.8)	156 (396.3)	168 (426.8)	180 (457.2)	192 (487.7)
36 (96)	654	768	857	901	1037	1056	1125	1399	1492	1554	1637	1726	1847	1859
48 (122)	716	856	961	1012	1169	1187	1277	1561	1681	1761	1842	1948	2094	2112
60 (152.4)	806	938	1067	1125	1303	1323	1430	1731	1859	1963	2042	2168	2345	2363
72 (182.9)	848	1027	1169	1238	1430	1452	1530	1840	2054	2164	2244	2389	2590	2609
84 (213.4)	909	1110	1276	1336	1561	1575	1679	1970	2241	2360	2451	2609	2843	2862
96 (243.9)	972	1196	1380	1471	1690	1710	1847	2164	2428	2564	2656	2834	3096	3109

### Add Surcharge to Shade Price

Privacy Liner	204	208	220	220	220	226	231	239	241	243	250	255	264	268
Room-Darkening Liner	264	268	285	285	285	291	298	303	310	322	325	333	340	348

NOTE: Price includes premiere valance. Must provide desired valance options.

### 60% Drapery Fullness

Height up to inches (cm) ↓	Width up to inches (cm) →													
	48 (122)	60 (152.4)	72 (182.9)	78 (198.2)	84 (213.4)	96 (243.9)	108 (274.4)	120 (304.8)	132 (335.3)	144 (365.8)	156 (396.3)	168 (426.8)	180 (457.2)	192 (487.7)
36 (96)	998	1172	1308	1374	1582	1612	1716	2135	2277	2372	2498	2635	2818	2838
48 (122)	1092	1306	1467	1545	1784	1812	1949	2383	2565	2687	2810	2972	3195	3222
60 (152.4)	1231	1432	1628	1716	1988	2019	2182	2642	2838	2996	3117	3309	3578	3606
72 (182.9)	1293	1568	1784	1890	2182	2217	2334	2807	3133	3302	3425	3645	3953	3982
84 (213.4)	1388	1694	1947	2038	2383	2403	2562	3006	3420	3601	3740	3982	4338	4367
96 (243.9)	1484	1824	2105	2244	2579	2608	2818	3302	3704	3912	4053	4323	4724	4743

### Add Surcharge to Shade Price

Privacy Liner	325	333	351	351	351	361	372	382	386	390	399	409	418	427
Room-Darkening Liner	418	427	458	458	458	467	474	483	504	513	520	531	544	557

NOTE: Price includes premiere valance. Must provide desired valance options.

Bellamy			
Rustic Weave	80820	Camel	80821

Lipo			
Ambrosia	06702	Earthtones	06793
		Natural	60706

Serenity	
Haze	11502

**Price Group J: Brooklyn, Denver, Inan, Kelton, Reminisce, Toushan II**

**Standard Drapery Fullness**

Width up to inches (cm) →

Height up to inches (cm) ↓	48 (122)	60 (152.4)	72 (182.9)	78 (198.2)	84 (213.4)	96 (243.9)	108 (274.4)	120 (304.8)	132 (335.3)	144 (365.8)	156 (396.3)	168 (426.8)	180 (457.2)	192 (487.7)
<b>36 (96)</b>	703	830	922	968	1118	1140	1243	1547	1648	1719	1812	1910	2041	2061
<b>48 (122)</b>	771	921	1037	1090	1258	1279	1414	1731	1857	1947	2039	2158	2319	2338
<b>60 (152.4)</b>	864	1015	1148	1211	1401	1423	1580	1916	2061	2169	2258	2399	2595	2614
<b>72 (182.9)</b>	909	1107	1258	1334	1543	1561	1747	2099	2272	2387	2482	2644	2757	2887
<b>84 (213.4)</b>	986	1199	1373	1474	1684	1703	1916	2285	2427	2609	2709	2887	3148	3165
<b>96 (243.9)</b>	1048	1291	1483	1580	1822	1842	2086	2469	2684	2835	2938	3136	3423	3439

**Add Surcharge to Shade Price**

<b>Privacy Liner</b>	204	208	220	220	220	226	231	239	241	243	250	255	264	268
<b>Room-Darkening Liner</b>	264	268	285	285	285	291	298	303	310	322	325	333	340	348

NOTE: Price includes premiere valance. Must provide desired valance options.

**60% Drapery Fullness**

Width up to inches (cm) →

Height up to inches (cm) ↓	48 (122)	60 (152.4)	72 (182.9)	78 (198.2)	84 (213.4)	96 (243.9)	108 (274.4)	120 (304.8)	132 (335.3)	144 (365.8)	156 (396.3)	168 (426.8)	180 (457.2)	192 (487.7)
<b>36 (96)</b>	1074	1267	1408	1478	1706	1740	1898	2361	2514	2623	2763	2915	3116	3145
<b>48 (122)</b>	1177	1405	1582	1662	1920	1952	2158	2642	2835	2971	3113	3292	3537	3568
<b>60 (152.4)</b>	1318	1548	1752	1849	2138	2172	2411	2922	3145	3310	3446	3661	3959	3988
<b>72 (182.9)</b>	1388	1690	1920	2035	2354	2383	2667	3204	3467	3642	3787	4035	4208	4406
<b>84 (213.4)</b>	1504	1829	2095	2250	2570	2598	2922	3487	3702	3982	4133	4406	4802	4830
<b>96 (243.9)</b>	1599	1970	2265	2411	2781	2810	3183	3768	4096	4326	4482	4786	5223	5249

**Add Surcharge to Shade Price**

<b>Privacy Liner</b>	325	333	351	351	351	361	372	382	386	390	399	409	418	427
<b>Room-Darkening Liner</b>	418	427	458	458	458	467	474	483	504	513	520	531	544	557

NOTE: Price includes premiere valance. Must provide desired valance options.

<b>Brooklyn</b>	
Weathered Beige	15870 Swan 15871
<b>Denver</b>	
Flax Seed	55750 Sweet Cream 55751 Foggy Blue Ridge 55752
<b>Inan</b>	
Umber	04858
<b>Kelton</b>	
True White	25890 Ivory 25891 Jet Black 25892
Soft Coal	25893
<b>Reminisce</b>	
Faded Slate	32360 Faded Star White 32361 Fossil Gray 32363
<b>Toushan II</b>	
Taupe	63659

## Price Group K: Moniz, Sarto, Stateside

### Standard Drapery Fullness

Height up to inches (cm) ↓	Width up to inches (cm) →													
	48 (122)	60 (152.4)	72 (182.9)	78 (198.2)	84 (213.4)	96 (243.9)	108 (274.4)	120 (304.8)	132 (335.3)	144 (365.8)	156 (396.3)	168 (426.8)	180 (457.2)	192 (487.7)
36 (96)	821	913	1078	1083	1249	1270	1387	1725	1842	1923	2021	2133	2277	2300
48 (122)	902	1012	1209	1215	1402	1429	1577	1929	2071	2173	2273	2406	2586	2608
60 (152.4)	940	1123	1266	1351	1565	1589	1765	2136	2300	2421	2520	2678	2895	2918
72 (182.9)	1008	1214	1467	1489	1718	1744	1954	2342	2537	2662	2768	2953	3201	3224
84 (213.4)	1091	1398	1603	1642	1879	1896	2136	2541	2762	2913	3028	3224	3509	3533
96 (243.9)	1155	1504	1732	1765	2031	2059	2413	2757	2996	3162	3277	3500	3824	3836

### Add Surcharge to Shade Price

Privacy Liner	204	208	220	220	220	226	231	239	241	243	250	255	264	268
Room-Darkening Liner	264	268	285	285	285	291	298	303	310	322	325	333	340	348

NOTE: Price includes premiere valance. Must provide desired valance options.

### 60% Drapery Fullness

Height up to inches (cm) ↓	Width up to inches (cm) →													
	48 (122)	60 (152.4)	72 (182.9)	78 (198.2)	84 (213.4)	96 (243.9)	108 (274.4)	120 (304.8)	132 (335.3)	144 (365.8)	156 (396.3)	168 (426.8)	180 (457.2)	192 (487.7)
36 (96)	1252	1393	1646	1653	1906	1938	2117	2633	2810	2934	3085	3255	3475	3509
48 (122)	1376	1545	1846	1855	2140	2181	2406	2944	3161	3317	3469	3671	3946	3981
60 (152.4)	1436	1713	1932	2063	2388	2427	2694	3260	3509	3695	3847	4087	4419	4453
72 (182.9)	1538	1853	2238	2272	2622	2660	2981	3574	3872	4062	4224	4506	4884	4920
84 (213.4)	1663	2133	2445	2506	2868	2893	3260	3878	4216	4444	4622	4920	5355	5391
96 (243.9)	1762	2296	2644	2694	3099	3142	3683	4208	4572	4826	5003	5340	5836	5855

### Add Surcharge to Shade Price

Privacy Liner	325	333	351	351	351	361	372	382	386	390	399	409	418	427
Room-Darkening Liner	418	427	458	458	458	467	474	483	504	513	520	531	544	557

NOTE: Price includes premiere valance. Must provide desired valance options.

Moniz					
Finland	05080	Peru	05081	Austria	05083
Belgium	05084				

Sarto			
Fawn	75800	Burlap	75810

Stateside					
Tiki	85830	Fossil Gray	85831	Admiral Navy	85832
Faded Star White	85833				

**Price Group L: Boardwalk, Hadley, Merino, Selene, Wild Haven**

**Standard Drapery Fullness**

Height up to inches (cm) ↓	Width up to inches (cm) →													
	48 (122)	60 (152.4)	72 (182.9)	78 (198.2)	84 (213.4)	96 (243.9)	108 (274.4)	120 (304.8)	132 (335.3)	144 (365.8)	156 (396.3)	168 (426.8)	180 (457.2)	192 (487.7)
<b>36 (96)</b>	831	979	1096	1211	1398	1424	1552	1935	2061	2152	2261	2389	2546	2573
<b>48 (122)</b>	916	1091	1226	1360	1571	1602	1765	2161	2321	2432	2544	2690	2894	2921
<b>60 (152.4)</b>	947	1200	1359	1517	1751	1780	1977	2395	2573	2710	2823	2999	3242	3265
<b>72 (182.9)</b>	1075	1312	1487	1664	1922	1953	2185	2622	2837	2982	3100	3303	3583	3608
<b>84 (213.4)</b>	1162	1418	1625	1845	2101	2123	2395	2837	3097	3261	3389	3608	3927	3956
<b>96 (243.9)</b>	1237	1524	1758	1977	2274	2301	2730	3084	3353	3541	3669	3915	4279	4293

**Add Surcharge to Shade Price**

<b>Privacy Liner</b>	204	208	220	220	220	226	231	239	241	243	250	255	264	268
<b>Room-Darkening Liner</b>	264	268	285	285	285	291	298	303	310	322	325	333	340	348

NOTE: Price includes premiere valance. Must provide desired valance options.

**60% Drapery Fullness**

Height up to inches (cm) ↓	Width up to inches (cm) →													
	48 (122)	60 (152.4)	72 (182.9)	78 (198.2)	84 (213.4)	96 (243.9)	108 (274.4)	120 (304.8)	132 (335.3)	144 (365.8)	156 (396.3)	168 (426.8)	180 (457.2)	192 (487.7)
<b>36 (96)</b>	1268	1492	1672	1849	2133	2174	2368	2953	3145	3285	3451	3645	3885	3926
<b>48 (122)</b>	1398	1663	1870	2073	2396	2443	2694	3297	3540	3711	3882	4106	4417	4457
<b>60 (152.4)</b>	1445	1830	2072	2314	2673	2716	3016	3654	3926	4135	4310	4577	4948	4982
<b>72 (182.9)</b>	1641	2002	2269	2540	2933	2980	3333	4002	4329	4551	4731	5041	5467	5506
<b>84 (213.4)</b>	1774	2164	2480	2815	3207	3240	3654	4329	4726	4976	5171	5506	5993	6037
<b>96 (243.9)</b>	1889	2326	2682	3016	3471	3511	4165	4706	5116	5404	5599	5975	6529	6552

**Add Surcharge to Shade Price**

<b>Privacy Liner</b>	325	333	351	351	351	361	372	382	386	390	399	409	418	427
<b>Room-Darkening Liner</b>	418	427	458	458	458	467	474	483	504	513	520	531	544	557

NOTE: Price includes premiere valance. Must provide desired valance options.

<b>Boardwalk</b>					
Pier	15968	Light Fossil Gray	15961	Saddlery	15962
<b>Hadley</b>					
Ivory Elegance	35910	Silver Mist	35911		
<b>Merino</b>					
Grenada	55507	Faded Star White	50510	Stardust	50511
<b>Selene</b>					
Oatmeal	30900	Sophisticated Slate	30901	Vanilla Cream	30902
<b>Wild Haven</b>					
Faded Star White	47465	Light Fossil Gray	47466	Porch Swing	47467
Sandpiper	47468				

**Price Group M: Oxford, Paralian, Tatum**

**Standard Drapery Fullness**

Height up to inches (cm) ↓	Width up to inches (cm) →													
	48 (122)	60 (152.4)	72 (182.9)	78 (198.2)	84 (213.4)	96 (243.9)	108 (274.4)	120 (304.8)	132 (335.3)	144 (365.8)	156 (396.3)	168 (426.8)	180 (457.2)	192 (487.7)
36 (96)	997	1174	1315	1453	1678	1710	1863	2323	2473	2582	2713	2866	3055	3087
48 (122)	1099	1309	1471	1632	1884	1922	2119	2593	2784	2918	3053	3229	3473	3505
60 (152.4)	1129	1440	1630	1820	2101	2136	2372	2874	3087	3252	3389	3599	3890	3918
72 (182.9)	1291	1575	1785	1998	2306	2344	2621	3148	3404	3579	3720	3964	4300	4330
84 (213.4)	1395	1703	1950	2213	2521	2547	2874	3404	3716	3913	4066	4330	4712	4747
96 (243.9)	1484	1829	2109	2372	2730	2761	3275	3701	4023	4250	4402	4698	5135	5152

**Add Surcharge to Shade Price**

Privacy Liner	204	208	220	220	220	226	231	239	241	243	250	255	264	268
Room-Darkening Liner	264	268	285	285	285	291	298	303	310	322	325	333	340	348

NOTE: Price includes premiere valance. Must provide desired valance options.

**60% Drapery Fullness**

Height up to inches (cm) ↓	Width up to inches (cm) →													
	48 (122)	60 (152.4)	72 (182.9)	78 (198.2)	84 (213.4)	96 (243.9)	108 (274.4)	120 (304.8)	132 (335.3)	144 (365.8)	156 (396.3)	168 (426.8)	180 (457.2)	192 (487.7)
36 (96)	1522	1791	2007	2219	2561	2608	2843	3543	3775	3941	4141	4374	4662	4711
48 (122)	1678	1998	2244	2490	2875	2933	3233	3956	4249	4453	4659	4926	5299	5349
60 (152.4)	1722	2197	2488	2778	3207	3260	3619	4386	4711	4963	5171	5492	5937	5979
72 (182.9)	1970	2403	2723	3049	3518	3577	3999	4802	5195	5461	5677	6050	6561	6607
84 (213.4)	2128	2598	2975	3377	3848	3887	4386	5195	5671	5971	6206	6607	7191	7245
96 (243.9)	2266	2791	3219	3619	4165	4214	5000	5647	6140	6485	6719	7170	7835	7863

**Add Surcharge to Shade Price**

Privacy Liner	325	333	351	351	351	361	372	382	386	390	399	409	418	427
Room-Darkening Liner	418	427	458	458	458	467	474	483	504	513	520	531	544	557

NOTE: Price includes premiere valance. Must provide desired valance options.

<b>Oxford</b>					
Tender Taupe	45740	French Roast	45741	Crisp Cotton	45742
Ebony	45743				

<b>Paralian</b>				
Mink	25050	Otter	25052	

<b>Tatum</b>	
Warm Wicker	70790

**Price Group N: Bayport, Berwick, Cherish**

**Standard Drapery Fullness**

Height up to inches (cm) ↓	Width up to inches (cm) →													
	48 (122)	60 (152.4)	72 (182.9)	78 (198.2)	84 (213.4)	96 (243.9)	108 (274.4)	120 (304.8)	132 (335.3)	144 (365.8)	156 (396.3)	168 (426.8)	180 (457.2)	192 (487.7)
<b>36 (96)</b>	1197	1409	1579	1744	2013	2052	2235	2787	2968	3099	3257	3439	3666	3704
<b>48 (122)</b>	1318	1571	1765	1958	2261	2306	2543	3111	3341	3502	3664	3875	4167	4205
<b>60 (152.4)</b>	1355	1728	1956	2185	2521	2564	2846	3449	3704	3903	4066	4319	4668	4703
<b>72 (182.9)</b>	1549	1890	2141	2398	2768	2813	3145	3777	4086	4294	4465	4758	5160	5195
<b>84 (213.4)</b>	1673	2042	2339	2655	3026	3057	3449	4086	4460	4696	4879	5195	5655	5697
<b>96 (243.9)</b>	1782	2196	2532	2846	3275	3315	3932	4441	4828	5099	5283	5638	6161	6183

**Add Surcharge to Shade Price**

<b>Privacy Liner</b>	204	208	220	220	220	226	231	239	241	243	250	255	264	268
<b>Room-Darkening Liner</b>	264	268	285	285	285	291	298	303	310	322	325	333	340	348

NOTE: Price includes premiere valance. Must provide desired valance options.

**60% Drapery Fullness**

Height up to inches (cm) ↓	Width up to inches (cm) →													
	48 (122)	60 (152.4)	72 (182.9)	78 (198.2)	84 (213.4)	96 (243.9)	108 (274.4)	120 (304.8)	132 (335.3)	144 (365.8)	156 (396.3)	168 (426.8)	180 (457.2)	192 (487.7)
<b>36 (96)</b>	1826	2150	2409	2660	3071	3130	3411	4254	4530	4730	4970	5249	5594	5653
<b>48 (122)</b>	2013	2396	2694	2989	3451	3518	3881	4747	5099	5344	5591	5913	6358	6418
<b>60 (152.4)</b>	2067	2636	2984	3333	3848	3912	4344	5264	5653	5954	6206	6591	7123	7176
<b>72 (182.9)</b>	2364	2884	3267	3659	4224	4292	4799	5764	6235	6554	6812	7259	7874	7928
<b>84 (213.4)</b>	2553	3117	3570	4052	4617	4665	5264	6235	6805	7167	7446	7928	8629	8693
<b>96 (243.9)</b>	2719	3351	3863	4344	5000	5057	5999	6777	7368	7782	8062	8603	9403	9435

**Add Surcharge to Shade Price**

<b>Privacy Liner</b>	325	333	351	351	351	361	372	382	386	390	399	409	418	427
<b>Room-Darkening Liner</b>	418	427	458	458	458	467	474	483	504	513	520	531	544	557

NOTE: Price includes premiere valance. Must provide desired valance options.

<b>Bayport</b>	
Sand Dune	23190
<b>Berwick</b>	
Sand Wood	43195
<b>Cherish</b>	
Natural Sparkle	53205



## Options Pricing

Natural Shade Options	
Angled Top	262 Add to price of standard shade using angled width and longest height
Bay or Corner Window	No charge
Bottom Up/Top Down	104
Continuous-Loop Lift	104 per panel
Cord Cleats	6 Antique brass 11 Solid brass
Cord Winder	9
Cut-outs	71
Edge Banding	146 Standard 184 Looped 146 Old Style 60 Valance only
Hem Options: Standard Hem	No charge
Hold Down Brackets	No charge; Extend from side of hem and must be requested at time of order
Liners (Privacy and Room-Darkening)	See price charts
Motorized Lift: Standard and Old Style Roman Shades	See motorization product information guide
Multiple Shades on One Headrail	If smaller than maximum width, surcharge applies: 104 Two-on-one headrail 104 Three-on-one headrail
Projection Brackets (2" (5.1 cm), 2 5/8" (6.7 cm), 3 1/2" (8.9 cm))	No charge
Returns: 2" (5.1 cm) for Shades	No charge (available on turned headrail)
Side Mount Bracket	No charge
Turned Headrail	No charge
Valances: 6" (15.3 cm) 9" (22.9 cm) Premiere Deco-Trim	No charge 15 No charge for continuous-loop lift or motorized lift See price charts See price charts
Wood Cornices and Valances	See cornices and valances product information guide
Natural Drape Options	
Ceiling Brackets	No charge
Drape Fullness: Standard or 60%	See price charts
Edge Banding for Top, Bottom, and Valance	No charge
Edge Banding for Drape Side: Optional	No charge
No Valance: Optional	No charge
Liner (Privacy or Room-Darkening) (option at time of order)	See price charts
Premiere Valance (included at time of order)	No charge at time of order; for premiere valance only, see price chart
Wood Cornices and Valances	See cornices and valances product information guide

## Premiere Valance Only

Width up to inches (cm) →

18	24	28	32	36	42	48	54	60	66	72
(96)	(61)	(71.2)	(81.3)	(91.5)	(106.7)	(122)	(137.2)	(152.4)	(167.7)	(182.9)

Premiere Valance	102	114	126	145	155	176	196	216	235	255	272
Liner on Valance (Privacy or Room-Darkening)	15	18	21	28	30	34	37	41	44	49	53

Width up to inches (cm) →

78	84	90	96	108	120	144	156	168	180	192
(198.2)	(213.4)	(228.6)	(243.9)	(274.4)	(304.8)	(365.8)	(396.3)	(426.8)	(457.2)	(487.7)

Premiere Valance	293	313	333	352	392	432	471	511	551	591	630
Liner on Valance (Privacy or Room-Darkening)	55	58	60	62	73	81	97	116	136	154	174