

# DESIGN ART™

by ORION



CELEBRATE YOUR CREATIVITY...

2015 Drapery Hardware Catalog



# CELEBRATE YOUR CREATIVITY...



From elegantly simple to exquisitely detailed, Design Art by Orion presents gorgeous drapery hardware designs. Products are offered in **58 hand-painted Décor Finishes, in our unique Dual Finish System with 11 Accent Finishes** , or in your own custom finish.

At Design Art, customization is our specialty, and every order is carefully created by Orion's artisans. Whether you want traversing poles (manual or motorized), or great, originally styled finials, poles, rings, brackets, centerpieces or medallions, Design Art - **proudly made in the USA** - is hand-painted just for you...



# Table of Contents

Finials 5 - 14

For 1-3/8", 2", 2-1/4" and 3" Poles

Rod-Enders 15 - 20

For 1-3/8", 2", 2-1/4" and 3" Poles

Crystal Collection 21 - 36

SwissCrystal-On-Wood For 1-3/8", 2", 2-1/4" and 3" Poles

SwissCrystal Holdbacks and Medallions

SwissCrystal-On-Iron For 1-1/4" Rods

Bohemia-On-Wood For 1-3/8", 2" and 2-1/4" Poles

Inlay Collection 37 - 51

10 Inlay Designs for 2-1/4" and 3" Poles

Wood Poles, Traversing & Motorization 52 - 56

Pole Styles: Smooth, Fluted, Rope and Inlay

Manual Traversing Poles

Manual Traversing Accessories

Motorized Traversing Poles

Motorized Traversing Accessories

Accessories 57 - 64

Brackets, Batons, Rings and Holdbacks

Elegant Adornments 65 - 66

Centerpieces for Poles

Crystal Stair Newels

Medallions

Finishes 67 - 80

58 Décor Finishes: Groups A & B

Dual Finish System with 11 Accent Finishes 

Custom Palette

Finish Notes

Selling Tools 81 - 82

Wall Displays

TableTopper Display and ShowOff Samples

Promotional Binder: Catalog and Finishes

Index 83 - 84

Measurements 85

Hand-Made in USA 86



Finials  
Pages 5-14



Rod-Enders  
Pages 15-20



Crystal  
Collection  
Pages 21-36

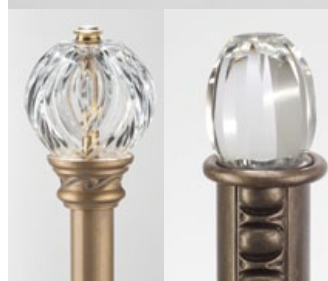

Inlay  
Collection  
Pages 37-51



Wood Poles,  
Traversing &  
Motorization  
Pages 52-56



Accessories  
Pages 57-64



Elegant  
Adornments  
Pages 65-66



Finishes  
Pages 67-80



# DESIGN ART BY ORION

## “What do you want in a drapery hardware line?”

**That’s what we asked Designers,**  
and then we took their answers and we created Design Art.

Here are some of the wishes Designers expressed:

### Finials & Rod-Enders:

*“Sophisticated.” “Simple.” “Design originality & flexibility.”*

- All original designs with styles ranging from simple and petite, to sophisticated and grand.
- Each finial fits at least 2 pole sizes to increase design options.



### Crystal:

*“Distinctive, gorgeous designs.” “Multi-functional.”*

- Design freedom to mix and match 16 styles of SwissCrystal with 28 SwissCrystal Bases and 4 SwissCrystal Medallions Bases.
- SwissCrystal Finials for wood poles and iron rods; for medallions, holdbacks and stair newels.
- 16 Bohemia Crystal finial designs for wood poles and holdbacks.



### Inlay:

*“Really unique and unusual designs.”*

- 10 original Inlay Design patterns for 2-1/4” and 3” poles.
- Matching or coordinating finials, rings, brackets, SwissCrystal bases and decals.



### Poles:

*“Manual traversing.” “Motorized.” “In all sizes & in long lengths.”*

- Poles with finials and all accessories in 1-3/8”, 2”, 2-1/4” and 3”.
- Round or traversing (manual or motorized); with rings or without. Up to 30 feet for traversing.



### Accessories:

*“More than just the basics. New pieces with special features.”*

- Brackets – Simple to magnificent.
- Holdbacks – Iron U-Bends and Posts in Iron or Wood.
- Rings – Smooth to ornate; round and traversing styles.



### Elegant Adornments

*“The finishing touches.”*

- Centerpieces for Poles - Add accents to your poles.
- SwissCrystal Stair Newels - Coordinate stairs and bannisters.
- Medallions - 3 designs to choose from in multiple projections.



## Finishes:

*"Lots and lots of choices in finishes...with finish combinations we can choose ourselves."  
"Every finish offered on every item."*

Throughout the catalog, you'll see 2 items side by side -

**In Single Décor Finish**  
58 Décor Finishes



**Garland Finial** shown in  
Gold Leaf-Antiqued (B).

*Elegantly Simple – Group A or Group B Finish*

**In Dual Finish System with 11 Accent Finishes**   
Décor Finish + Accent Finish



**Garland Finial** shown in Paris Rain with  
Gold Leaf-Burnished Accents (C).

*Exquisitely Detailed – Group C Finish*

Item numbers are shown before the dash, the pole size is after the dash. \*Finial shown with Adaptor.

**With our 58 Décor Finishes,  
plus our unique Dual Finish System with 11 Accent Finishes**   
there are **685 possible Finish combinations...**

Plus...

**Custom Colors** – Our Custom Palette program allows you to match or select any  
**Benjamin Moore** or **Sherwin Williams** color.

## What else?

*"I want to be able to create my own individual look for clients."*

We heard that time and time again...

**And we created Design Art so that you have the freedom to...**

- Combine finials, poles, brackets, rings and other unique design products to create your own individual look.
- And then select from 685 possible hand-painted finish combinations, plus Custom Colors...  
all hand-painted just for you in the USA.



**58 Hand-Painted Décor Finishes**

**Design Art** – Created with you, the professional Designer, in mind.  
Celebrate your Creativity.

# FINIALS



# DESIGN ART BY ORION

## CELEBRATE YOUR CREATIVITY... with the originally designed, artistic finials of Design Art.

### Our original, hand-painted designs:

Created to give you, the Designer, an almost limitless selection of finials and finishes, styles and sizes, to meet all your decorating needs.

All finials are available in 58 Hand-Painted Décor Finishes, or our Dual Finish System with 11 Accent Finishes  to create your own unique designs.

By our count, there are **685 possible combinations** of Décor Finishes and Accent Finishes.

But, if those are not enough colors, you can choose your own Custom Colors. As part of our Custom Palette program, your choice of colors is infinite.

*(Please see catalog pages 79-80.)*

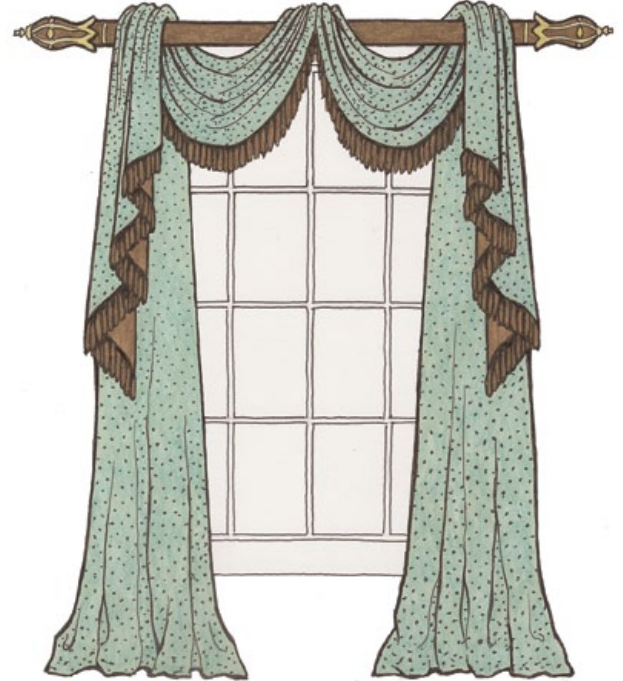

With our unique Adaptor,  
select your finial & still enjoy the freedom  
to choose your pole size!

To increase your creative freedom,  
all Design Art finials **are designed**  
**to fit more than one size pole.**

Just select your pole size and your finial.  
An adaptor will be added automatically  
when needed, so that the finial fits the  
pole size you have chosen at no  
additional charge.



**Autumn Finial DF500-3**  
shown in Mahogany with  
Gold Leaf-Traditional Accents (C).

**Adaptor**



# FINIALS

Finials fit 1-3/8" poles. With Adaptor added, finials fit 2" or 2-1/4" poles.



DF402-1

**Bouquet Finial** (3-3/4"L x 3-1/4"H) shown in Champagne (B).



DF402-2\*

**Bouquet Finial** (4-3/8"L x 3-1/4"H) shown in Clouds with Gold Leaf-Antiqued Accents (C).



DF107-1

**Festival Finial** (3-5/8"L x 2-3/8"H) shown in Antique Gold (A).



DF107-2\*

**Festival Finial** (4-1/4"L x 2-3/8"H) shown in Hammered Silver with Silver Leaf-Burnished Accents (C).



DF106-1

**Holiday Finial** (4-3/8"L x 2-1/2"H) shown in Frosty Morn (A).



DF106-2\*

**Holiday Finial** (5"L x 2-1/2"H) shown in Urbane Bronze with Black-Satin Accents (C).



DF101-2\*

**Hospitality Finial** (4-5/8"L x 2-3/4"H) shown in Aged Brass (B).



DF101-1

**Hospitality Finial** (4"L x 2-3/4"H) shown in Bronze Pewter with Gold Leaf-Traditional Accents (C).

\*Finial shown with Adaptor.



Finials fit 1-3/8" poles. With Adaptor added, finials fit 2" or 2-1/4" poles.

# FINIALS



**Keepsake Finial** (4"L x 2-7/8"H) shown in English Bronze (A).



**Keepsake Finial** (4-5/8"L x 2-7/8"H) shown in Superior Bronze with Gold Leaf-Traditional Accents (C).

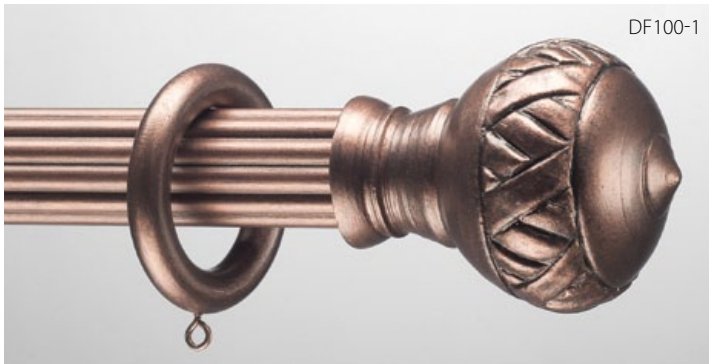

**Lattice Finial** (4"L x 3-1/8"H) shown in Copper Penny (A).



**Lattice Finial** (4-5/8"L x 3-1/8"H) shown in Italian Walnut with Gold Leaf-Antiqued Accents (C).



**Majesty Finial** (3-7/8"L x 3"H) shown in Cast Iron (A).



**Majesty Finial** (4-1/2"L x 3"H) shown in Antique Copper with Black-Satin Accents (C).



**Twirl Finial** (4-1/4"L x 3-1/8"H) shown in Creamy (B).



**Twirl Finial** (4-7/8"L x 3-1/8"H) shown in Bronze Vecchio with Gold Leaf-Antiqued Accents (C).

*\*Finial shown with Adaptor.*



# FINIALS

Finials fit 2" or 2-1/4" poles. With Adaptor added, finials fit 3" poles.



**Autumn Finial** (7-1/8"L x 3-3/4"H) shown in Sage (B).



**Autumn Finial** (7-3/4"L x 3-3/4"H) shown in Mahogany with Gold Leaf-Traditional Accents (C).



**Cameo Finial** (7-3/8"L x 3-1/2"H) shown in Champagne (B).



**Cameo Finial** (6-3/4"L x 3-1/2"H) shown in Queensland Walnut with Gold Leaf-Traditional Accents (C).



**Elegance Finial** (6-1/4"L x 3"H) shown in Gold Leaf-Antiqued (B).



**Elegance Finial** (6-1/4"L x 3"H) shown in Queensland Walnut with Gold Leaf-Burnished Accents (C).



**Eucalyptus Finial** (7-1/4"L x 3-1/4"H) shown in Royal Red (A).



**Eucalyptus Finial** (7-1/4"L x 3-1/4"H) shown in Antique Bronze with Gold Leaf-Burnished Accents (C).

\*Finial shown with Adaptor.

Finials fit 2" or 2-1/4" poles. With Adaptor added, finials fit 3" poles.

# FINIALS 2" - 3"



**Finery Finial** (5-1/4"L x 3-5/8"H) shown in Vintage Gold (B).

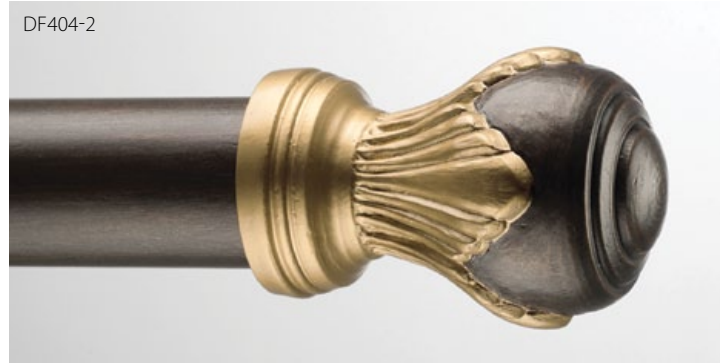

**Finery Finial** (5-1/4"L x 3-5/8"H) shown in Zinc with Liquid Gold Leaf Accents (C).



**Fleur de Lys Finial** (7-3/8"L x 3-3/8"H) shown in Zinc (B).



**Fleur de Lys Finial** (6-3/4"L x 3-1/4"H) shown in Copper Glimmer with Gold Leaf-Polished Accents (C).



**Fluted Ball Finial** (7-1/8"L x 4-1/4"H) shown in Weathered Iron (B).



**Fluted Ball Finial** (6-1/2"L x 4-1/4"H) shown in Mahogany with Black-Satin Accents (C).



**Fruit Finial** (6-1/2"L x 3-1/2"H) shown in Champagne (B).



**Fruit Finial** (7-1/8"L x 3-1/2"H) shown in Clouds with Liquid Gold Leaf Accents (C).

*\*Finial shown with Adaptor.*



# FINIALS

Finials fit 2" or 2-1/4" poles. With Adaptor added, finials fit 3" poles.



**Garland Finial** (7-3/8"L x 3-3/4"H) shown in Gold Leaf-Antiqued (B).



**Garland Finial** (6-3/4"L x 3-3/4"H) shown in Paris Rain with Gold Leaf-Burnished Accents (C).



**Harvest Finial** (7-1/4"L x 3-3/4"H) shown in Aged Chestnut (B).



**Harvest Finial** (6-5/8"L x 3-3/4"H) shown in Precious Metals with Gold Leaf-Antiqued Accents (C).



**Noble Finial** (6-7/8"L x 4"H) shown in Sage (B).



**Noble Finial** (7-1/2"L x 4"H) shown in Superior Bronze with Gold Leaf-Polished Accents (C).



**Oak & Acorn Finial** (6-3/4"L x 4"H) shown in Queensland Walnut (B).



**Oak & Acorn Finial** (7-3/8"L x 4"H) shown in French Nobility with Liquid Gold Leaf Accents (C).

\*Finial shown with Adaptor.

Finials fit 2" or 2-1/4" poles. With Adaptor added, finials fit 3" poles.

# FINIALS 2" - 3"



DF516-3\*

**Opera Finial** (7-1/8"L x 3-1/4"H) shown in Creamy (B).



DF516-2

**Opera Finial** (6-1/2"L x 3-1/4"H) shown in Cherrywood with Gold Leaf-Traditional Accents (C).



DF520-3\*

**Ornament Finial** (6-7/8"L x 3-3/4"H) shown in Bronze Pewter (A).



DF520-2

**Ornament Finial** (6-1/4"L x 3-3/4"H) shown in Ebony with Gold Leaf-Burnished Accents (C).



DF522-2

**Paisley Finial** (6-3/4"L x 3-3/4"H) shown in Vintage Gold (B).



DF522-3\*

**Paisley Finial** (7-3/8"L x 3-3/4"H) shown in Italian Walnut with Gold Leaf-Antiqued Accents (C).



DF070-2

**Pineapple Finial** (6-1/4"L x 3-5/8"H) shown in Gold Leaf-Traditional (B).



DF070-3\*

**Pineapple Finial** (6-7/8"L x 3-5/8"H) shown in Cherrywood with Gold Leaf-Traditional Accents (C).

*\*Finial shown with Adaptor.*



# FINIALS

Finials fit 2" or 2-1/4" poles. With Adaptor added, finials fit 3" poles.



**Pinwheel Finial** (6-3/4"L x 3-3/4"H) shown in White Dove (A).



**Pinwheel Finial** (7-3/8"L x 3-3/4"H) shown in Aged Chestnut with Gold Leaf-Antiqued Accents (C).



**Prestige Finial** (6-3/4"L x 4-1/4"H) shown in Vintage Gold (B).



**Prestige Finial** (7-3/8"L x 4-1/4"H) shown in Hickory with Black-Satin Accents (C).



**Royal Orb Finial** (6-1/4"L x 3-3/4"H) shown in English Bronze (A).



**Royal Orb Finial** (5-5/8"L x 3-3/4"H) shown in Cherrywood with Antique Bronze Accents (C).



**Scroll Finial** (7"L x 4"H) shown in Clouds (B).



**Scroll Finial** (7-5/8"L x 4"H) shown in French Nobility with Gold Leaf-Antiqued Accents (C).

\*Finial shown with Adaptor.

Finials fit 2" or 2-1/4" poles. With Adaptor added, finials fit 3" poles.

# FINIALS 2" - 3"



**Sonnet Finial** (7-5/8"L x 3-3/4"H) shown in Antique Bronze (A).



**Sonnet Finial** (7"L x 3-3/4"H) shown in Queensland Walnut with Gold Leaf-Traditional Accents (C).



**Tiara Finial** (6-1/8"L x 4"H) shown in Weathered Iron (B).



**Tiara Finial** (6-3/4"L x 4"H) shown in Mahogany with Gold Leaf-Traditional Accents (C).

*\*Finial shown with Adaptor.*



**You Design - We Create  
- Enjoy the Freedom!**

# ROD-ENDERS

## Uniquely designed Rod-Enders:

Elegant, smaller finials designed especially for tight corners or small spaces, while still complementing our traditional-size finials.

**Rod-Enders** are offered in several lengths -- from small sizes such as **Sonnet** (1") and **Opera** (1-1/4"), to larger sizes such as **Concerto** (3-1/8") to **Polonaise** (3-5/8").





DESIGN ART BY ORION

# CELEBRATE YOUR CREATIVITY...

with gorgeous Rod-Enders designed for those difficult, tight spaces.





# 1 3/8" ROD-ENDERS

Rod-Enders designed for 1-3/8" poles.  
Not Available in Dual Finish System Accent Finishes.



DE541-1

**Blossom Rod-End** (1-3/4"L x 2"H) shown in Weathered Iron (B).



DE541-1

**Blossom Rod-End** (1-3/4"L x 2"H) shown in Copper Glimmer (A).



DE513-1

**Plume Sleeve Rod-End** (2-3/4"L x 2"H) shown in Royal Red (A). Finial projects out from end of pole: 1-3/8".



DE513-1

**Plume Sleeve Rod-End** (2-3/4"L x 2"H) shown in Clouds (B). Finial projects out from end of pole: 1-3/8".



# 2" - 2 1/4" Rod-Enders designed for 2" and 2-1/4" poles. Not Available in Dual Finish System Accent Finishes.



DE540X-2

**Crest Rod-End** (2-1/2"L x 2-1/2"H) shown in Gold Leaf-Traditional (B).



DE540X-2

**Crest Rod-End** (2-1/2"L x 2-1/2"H) shown in English Bronze (A).



DE525-2

**Petals Sleeve Rod-End** (4-3/4"L x 2-3/4"H) shown in Urbane Bronze (A). Finial projects out from end of pole: 1-3/4".



DE525-2

**Petals Sleeve Rod-End** (4-3/4"L x 2-3/4"H) shown in Gold Leaf-Burnished (B). Finial projects out from end of pole: 1-3/4".

**Rod-Enders designed for 2", 2-1/4" and 3" poles.**  
Available in Dual Finish System Accent Finishes.

# ROD-ENDERS



**Ballet Rod-Ender** (2-5/8"L x 3-1/2"H) shown in Monarch (B).



**Ballet Rod-Ender** (2-5/8"L x 3-1/2"H) shown in Antique Bronze with Black-Satin Accents (C).



**Concerto Rod-Ender** (3-1/8"L x 3-3/4"H) shown in Silver Shimmer (A).



**Concerto Rod-Ender** (3-1/8"L x 3-3/4"H) shown in Ebony with Gold Leaf-Polished Accents (C).



**Cotillion Rod-Ender** (3-1/4"L x 3-7/8"H) shown in White Dove (A).



**Cotillion Rod-Ender** (3-1/4"L x 3-7/8"H) shown in Mahogany with Gold Leaf-Traditional Accents (C).

Examples of color combinations



**Stanza Rod-Ender** shown in Black Embers with Gold Leaf-Polished Accents (C).



**Concerto Rod-Ender** shown in Ebony with Gold Leaf-Polished Accents (C).



**Verse Rod-Ender** shown in Paris Rain with Silver Leaf-Burnished Accents (C).



# ROD-ENDERS

Rod-Enders designed for 2", 2-1/4" and 3" poles.  
Available in Dual Finish System Accent Finishes.



DE052-2

**Encore Rod-End** (2-3/4"L x 3-7/8"H) shown in Champagne (B).



DE052-2

**Encore Rod-End** (2-3/4"L x 3-7/8"H) shown in English Bronze with Gold Leaf-Traditional Accents (C).



DE598-2

**Michele Rod-End/Small** (1-1/2"L x 3"H) shown in Rusty (A).



DE594X-3

**Michele Rod-End/Large** (2-1/8"L x 3-3/8"H) shown in Zinc with Gold Leaf-Burnished Accents (C).



DE086-2

**Opera Rod-End/Small** (1-1/4"L x 4"H) shown in Precious Metals (B).



DE580X-3

**Opera Rod-End/Large** (1-7/8"L x 4"H) shown in Monarch with Gold Leaf-Traditional Accents (C).



DE043-3

**Overture Rod-End** (3-3/4"L x 4-1/4"H) shown in Paris Rain (B).



DE043-3

**Overture Rod-End** (3-3/4"L x 4-1/4"H) shown in Frosty Morn with Silver Leaf-Burnished Accents (C).

**Rod-Enders designed for 2", 2-1/4" and 3" poles.**  
Available in Dual Finish System Accent Finishes.

# ROD-ENDERS



**Polonaise Rod-Ender** (3-5/8"L x 4-1/4"H) shown in Italian Gold (B).



**Polonaise Rod-Ender** (3-5/8"L x 4-1/4"H) shown in Black Embers with Gold Leaf-Polished Accents (C).



**Sonnet Rod-Ender/Small** (1"L x 3-1/8"H) shown in Paris Rain (B).



**Sonnet Rod-Ender/Large** (1-5/8"L x 3-3/8"H) shown in Chateau with Gold Leaf-Traditional Accents (C).



**Stanza Rod-Ender** (2-1/2"L x 4-1/2"H) shown in Ebony (B).

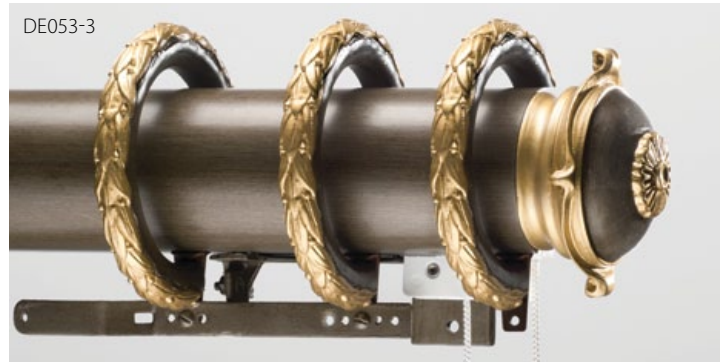

**Stanza Rod-Ender** (2-1/2"L x 4-1/2"H) shown in Cast Iron with Liquid Gold Leaf Accents (C).



**Verse Rod-Ender** (3-3/4"L x 4-3/8"H) shown in Aged Chestnut (B).



**Verse Rod-Ender** (3-3/4"L x 4-3/8"H) shown in Paris Rain with Silver Leaf-Burnished Accents (C).

# CRYSTAL

## SwissCrystal...

24% Full Lead

Mouth-Blown and Hand-Cut

### 16 Styles of SwissCrystal-On-Wood Finials

- 28 SwissCrystal Bases
- 4 SwissCrystal Medallions
- 4 Holdback Options

### SwissCrystal Bases and Medallions in

- 58 Hand-Painted Décor Finishes
- Dual Finish System with 11 Accent Finishes 
- Your Custom Colors

### 5 Styles of SwissCrystal-On-Iron Finials

- 5 Iron Finishes
- 5 Wood SwissCrystal Bases
- 2 Holdback Options

## Bohemia Crystal...

Hand-Crafted Faceted Crystal-Glass

### 16 Styles of Bohemia Crystal-On-Wood Finials

- Metal Adaptor Base
- 4 Holdback Options



DESIGN ART BY ORION  
CELEBRATE YOUR CREATIVITY...

with the sparkle of 24% full lead, hand-cut SwissCrystal Finials,  
hand crafted Bohemia Crystal Finials, Medallions & Holdbacks.



SwissCrystal-On-Wood

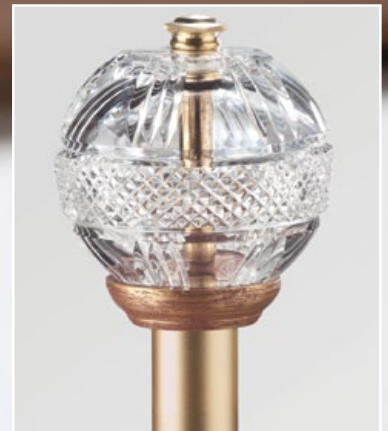

SwissCrystal-On-Iron

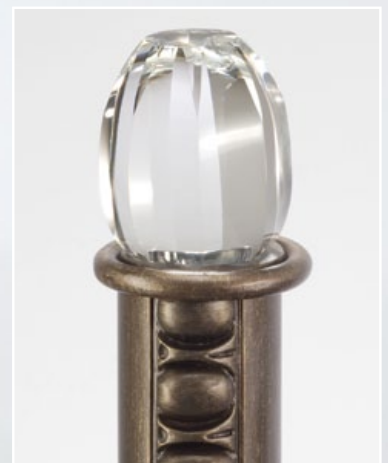

Bohemia Crystal-On-Wood



# SWISSCRYSTAL-ON-WOOD

Choose the SwissCrystal Finial, base and pole, then select your finish.

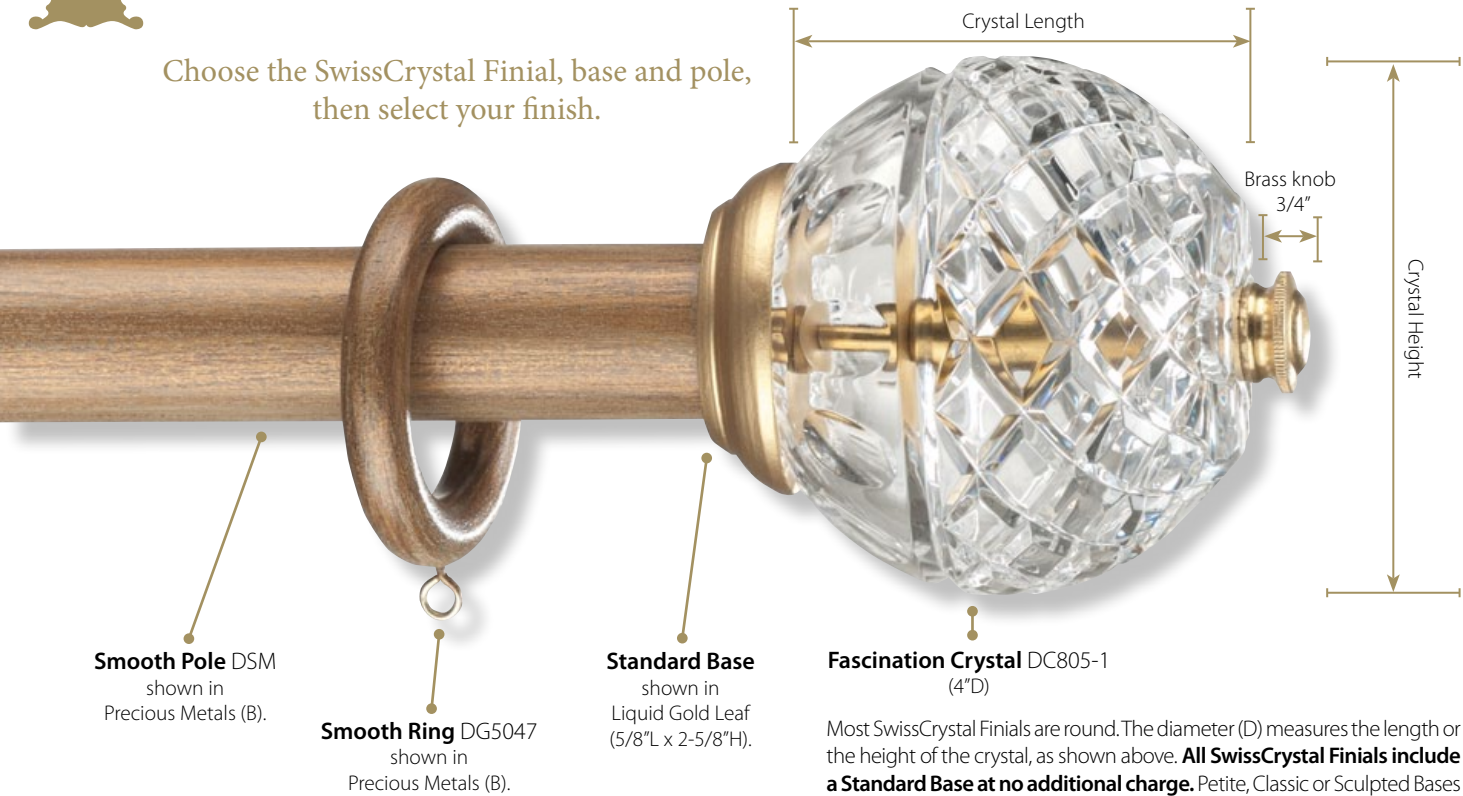

Most SwissCrystal Finials are round. The diameter (D) measures the length or the height of the crystal, as shown above. **All SwissCrystal Finials include a Standard Base at no additional charge.** Petite, Classic or Sculpted Bases can be selected at an additional charge. See Price List for details.

**Please Note:** SwissCrystal Finials are not shown to scale. They are presented to best show the hand-cut design of each crystal. SwissCrystal designs may slightly vary due to the nature of hand-made items.

### Petite Bases for 1-3/8" poles.

Petite Bases can be used with all 3"D and 4"D SwissCrystal Finials. Not Available in Dual Finish System Accent Finishes.



**Petite Elise Crystal** (3"D) shown with **Grecian Base** (1-7/8"L x 2-3/8"H): Silver Leaf-Polished (B). Pole: Silver Shimmer (A).



**Twinkle Crystal** (1-1/4"L x 3"H) shown with **Grecian Base** (1-7/8"L x 2-3/8"H) & pole: Antique Gold (A).



**Rainbow Arc Crystal** (4"D) shown with **Serenade Base** (1-1/2"L x 2-5/8"H) & pole: Champagne (B).



**Fascination Crystal** (4"D) shown with **Serenade Base** (1-1/2"L x 2-5/8"H) & pole: Creamy (B).



**Classic Bases for 2", 2-1/4" and 3" poles.**  
 Classic Bases can be used with all SwissCrystal Finials.  
 Not Available in Dual Finish System Accent Finishes.

# SWISSCRYSTAL-ON-WOOD



**Royal Egyptian Crystal** (6"D) shown on **Amanda Base**  
 (1-1/2"L x 5-3/4"H) & pole: Vintage Gold (B).



**Spring Flowers Crystal** (5"D) shown on **Amanda Base**  
 (1-1/2"L x 5-3/4"H) & pole: Burnt Gold (A).



**Starburst Crystal** (4"D) shown with **Aria Base**  
 (1-1/2"L x 3"H): Gold Leaf-Polished (B). Pole: Royal Red (A).



**Rainbow Arc Crystal** (4"D) shown with **Aria Base**  
 (1-1/2"L x 3"H) & pole: Burnt Gold (A).



**Rainbow Arc Crystal** (4"D) shown on **Cadenza Base**  
 (2-1/8"L x 4-1/2"H) & pole: Gold Leaf-Traditional (B).



**Fascination Crystal** (4"D) shown on **Cadenza Base**  
 (2-1/8"L x 4-1/2"H) & pole: Paris Rain (B).



# SWISSCRYSTAL-On-Wood

**Classic Bases for 2", 2-1/4" and 3" poles.**  
Classic Bases can be used with all SwissCrystal Finials.  
Not Available in Dual Finish System with Accent Finishes.

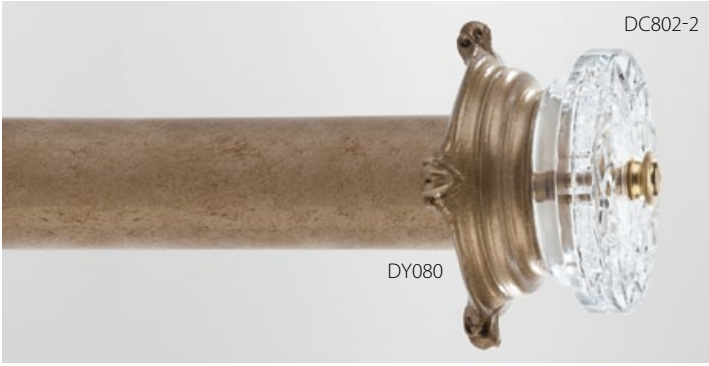

**Corona Crystal** (1-1/4"L x 4-1/4"H) shown on **Choir Base**  
(1-5/8"L x 5-3/8"H) & pole: Monarch (B).

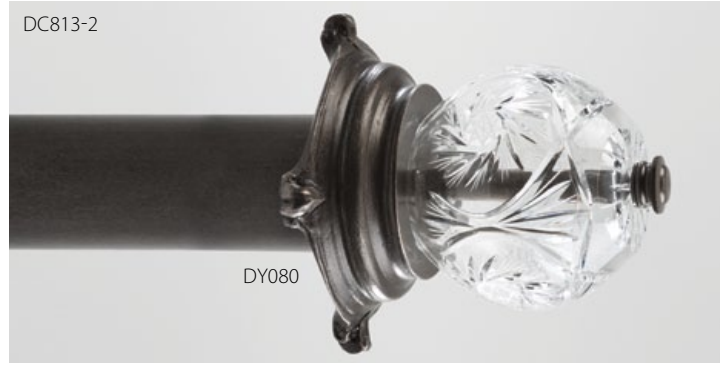

**Starburst Crystal** (4"D) shown on **Choir Base**  
(1-5/8"L x 5-3/8"H) & pole: Steel (A).



**Starburst Crystal** (4"D) shown with **Chorus Base**  
(1-5/8"L x 4-1/2"H) & pole: Gold Leaf-Traditional (B).

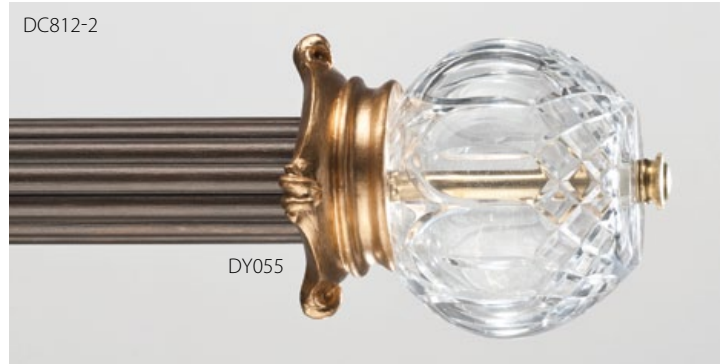

**Spring Flowers Crystal** (5"D) shown with **Chorus Base**  
(1-5/8"L x 4-1/2"H): Gold Leaf-Traditional (B). Pole: Zinc (B).



**Petite Elise Crystal** (3"D) shown with **Grace Base**  
(1-3/8"L x 3-5/8"H): Gold Leaf-Burnished (B). Pole: English Bronze (A).



**Windswept Crystal** (5"D) shown with **Grace Base**  
(1-3/8"L x 3-5/8"H): Gold Leaf-Polished (B). Pole: Champagne (B).



**Aurora Crystal** (5"D) shown with **Music Base**  
(2-3/8"L x 3-3/8"H) & pole: Weathered Iron (B).



**Old Pinwheel Crystal** (6"D) shown with **Music Base**  
(2-3/8"L x 3-3/8"H) & pole: Gold Leaf-Antiqued (B).

**Classic Bases for 2", 2-1/4" and 3" poles.**

Classic Bases can be used with all SwissCrystal Finials.  
Not Available in Dual Finish System with Accent Finishes.

# SWISSCRYSTAL-ON-WOOD



**Heritage Crystal** (5-1/2"L x 4"H) shown with **Opus Base** (3-5/8"L x 2-7/8") & pole: French Nobility (B).



**Spring Flowers Crystal** (5"D) shown with **Opus Base** (3-5/8"L x 2-7/8"H) & pole: Cherrywood (B).



**Heritage Crystal** (5-1/2"L x 4"H) shown with **Orchestra Base** (2"L x 3-7/8"H) & pole: Gold Leaf-Traditional (B).



**Fascination Crystal** (4"D) shown with **Orchestra Base** (2"L x 3-7/8"H) & pole: Sage (B).



**Diamonds Crystal** (4"D) shown with **Rhapsody Base** (2-1/8"L x 3-7/8"H) & pole: Frosty Morn (A).



**Spring Flowers Crystal** (5"D) shown with **Rhapsody Base** (2-1/8"L x 3-7/8"H): Gold Leaf-Polished (B). Pole: Italian Gold (B).



**Spring Flowers Crystal** (5"D) shown with **Symphony Base** (2-1/2"L x 4-1/4"H) & pole: Aged Brass (B).



**Aurora Crystal** (5"D) shown with **Symphony Base** (2-1/2"L x 4-1/4"H) & pole: Silver Leaf-Polished (B).

\*Base shown with Adaptor.



# SWISSCRYSTAL-On-Wood

Sculpted Bases for 2", 2-1/4" and 3" poles.  
Sculpted Bases can be used with all SwissCrystal Finials.



DC805-2

DY072

**Fascination Crystal** (4"D) shown with **Antique Base** (2-1/4"L x 3"H): Gold Leaf-Traditional (B). Pole: Queensland Walnut (B).



DC808-2

DY072

**Old Pinwheel Crystal** (6"D) shown with **Antique Base** (2-1/4"L x 3"H): Silver Shimmer with Liquid Gold Leaf Accents (C). Pole: Silver Shimmer (A).



DC803-2

DY510

**Diamonds Crystal** (4"D) shown with **Ballade Base** (3"L x 3-1/4"H): Gold Leaf-Antiqued (B). Pole: Mahogany (B).



DC805-2

DY510

**Fascination Crystal** (4"D) shown with **Ballade Base** (3"L x 3-1/4"H): Italian Gold with Gold Leaf-Antiqued Accents (C). Pole: Italian Gold (B).



DC801-2

DY503

**Aurora Crystal** (5"D) shown with **Caprice Base** (3"L x 3"H) & pole: Old Black (A).

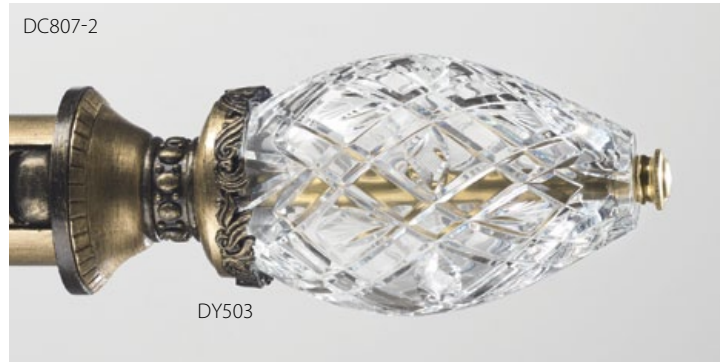

DC807-2

DY503

**Heritage Crystal** (5-1/2"L x 4"H) shown with **Caprice Base** (3"L x 3"H) & pole: Gold Leaf-Burnished with Black-Satin Accents (C).



DC804-2

DY612X

**Empress Crystal** (4"D) shown on **Dancer Base** (1-5/8"L x 4"H) & pole: Silver Shimmer (A).

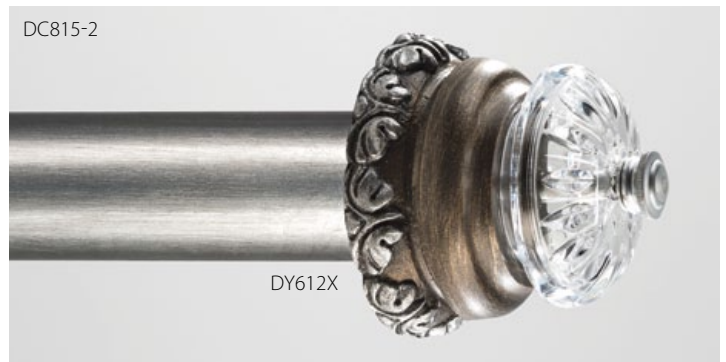

DC815-2

DY612X

**Twinkle Crystal** (1-1/4"L x 3"H) shown on **Dancer Base** (1-5/8"L x 4"H): English Bronze with Silver Leaf-Burnished Accents (C). Pole: Silver Leaf-Burnished (B).

**Sculpted Bases for 2", 2-1/4" and 3" poles.**  
 Sculpted Bases can be used with all SwissCrystal Finials.

# SWISSCRYSTAL-ON-WOOD



DC805-2

DY560

**Fascination Crystal (4"D)** shown on **Diva Base** (3-3/4"L x 4-1/8"H) & pole: Antique Copper (A).



DC811-2

DY560

**Royal Egyptian Crystal (6"D)** shown on **Diva Base** (3-3/4"L x 4-1-8"H) in Antique Bronze with Liquid Gold Leaf Accents (C). Pole: Antique Bronze (A).



DC803-2

DY046

**Diamonds Crystal (4"D)** shown with **Harmony Base** (2-7/8"L x 4-1/2"H): Gold Leaf-Polished (B). Pole: Chateau (B).



DC811-3

DY046

**Royal Egyptian Crystal (6"D)** shown with **Harmony Base** (2-7/8"L x 4-1/2"H) & pole: Italian Walnut with Gold Leaf-Traditional Accents (C).



DC809-2

DY519

**Petite Elise Crystal (3"D)** shown with **Lyric Base** (3-3/8"L x 3"H) & pole: Gold Leaf-Burnished (B).



DC801-3

DY519

**Aurora Crystal (5"D)** shown with **Lyric Base** (3-3/8"L x 3"H): Vintage Gold with Gold Leaf-Antiqued Accents (C). Pole: Vintage Gold (B).



DC808-3

DY526

**Old Pinwheel Crystal (6"D)** shown with **Medley Base** (3-1/8"L x 3-1/2"H) & pole: Royal Red (A).



DC810-2

DY526

**Rainbow Arc Crystal (4"D)** shown with **Medley Base** (3-1/8"L x 3-1/2"H) & pole: Aged Brass with Liquid Gold Leaf Accents (C).



# SWISSCRYSTAL-On-Wood

**Sculpted Bases for 2", 2-1/4" and 3" poles.**  
Sculpted Bases can be used with all SwissCrystal Finials.



DC813-2

DY632

**Starburst Crystal** (4"D) shown with **Operetta Base** (7/8"L x 3-1/2"H) & pole: Gold Leaf-Antiqued (B).



DC816-2

DY632

**Windswept Crystal** (5"D) shown with **Operetta Base** (7/8"L x 3-1/2"H): Aged Chestnut with Gold Leaf-Antiqued (C). Pole: Aged Chestnut (B).



DC816-3

DY041

**Windswept** (5"D) shown with **Prelude Base** (4-3/8"L x 4-1/4"H) & pole: Gold Leaf-Burnished (B).



DC808-3

DY041

**Old Pinwheel Crystal** (6"D) shown with **Prelude Base** (4-3/8"L x 4-1/4"H): Silver Shimmer with Liquid Gold Leaf Accents (C). Pole: Silver Shimmer (A).



DC814-3

DY003

**Timeless Crystal** (5"D) shown on **Sarah Base** (1"L x 6"H) & pole: Aged Chestnut (B).



DC806-3

DY003

**Halo Crystal** (1-1/4"L x 4-1/4"H) shown on **Sarah Base** (1"L x 6"H): Precious Metals Gold Leaf-Polished Accents (C). Pole: Precious Metals (B).



DC807-3

DY409

**Heritage Crystal** (5-1/2"L x 4"H) shown with **Sonata Base** (2-1/2"L x 4-1/2"H): Gold Leaf-Polished (B). Pole: Pure White-Glossy (A).



DC809-2

DY409

**Petite Elise Crystal** (3"D) shown with **Sonata Base** (2-1/2"L x 4-1/2"H): Mahogany with Gold Leaf-Traditional Accents (C). Pole: Mahogany (B).

**Sculpted Bases for 2", 2-1/4" and 3" poles.**  
 Sculpted Bases can be used with all SwissCrystal Finials.

# SWISSCRYSTAL-ON-WOOD



**Diamonds Crystal (4\"/>**



**Rainbow Arc Crystal (4\"/>**



**Royal Egyptian Crystal (6\"/>**



**Timeless Crystal (5\"/>**

## One Crystal, Multiple Ways...

With Design Art's  
 Combination of SwissCrystals,  
 Bases and Finishes, the  
 Possibilities are Nearly Endless!



**Rainbow Arc Crystal (4\"/>**



**Rainbow Arc Crystal (4\"/>**



**Rainbow Arc Crystal (4\"/>**



# CRYSTAL Holdbacks

**Crystal Holdbacks** are available in several design styles: **Iron U-Bend, Iron Post, Wood Post, or Pedestal Holdback.**

To order, select (1) the crystal and (2) the crystal base from pages 23-30, then (3) the holdback style. Some crystal bases may also be used with a flush mount.

See page 64 for more information on Holdbacks.  
Please see the price list for more details.

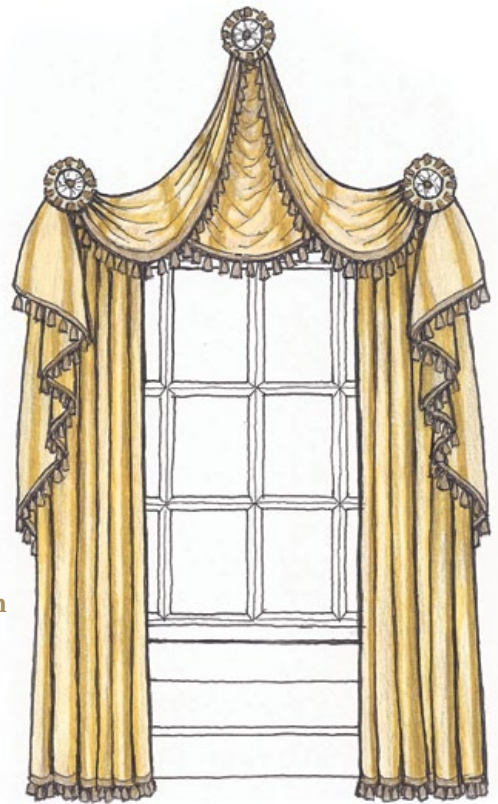

SwissCrystal Finials shown with the Sarah Medallion enhance the richness of these formal drapes.



**Iron U-Bend Holdbacks**  
3-1/2" projection

**Iron Post Holdbacks**  
Available in 3", 4", or 6-1/2" projections.



**Petite Elise Crystal** (3"D) on **Aria Base** (1-1/2"L x 3"H) shown on **Iron U Bend Holdback** (P3-1/2") in Black-Glossy (A).



**Starburst Crystal** (4"D) on **Antique Base** (2-1/4"L x 3"H) shown on **Iron Post Holdback** (P3") in Naturelle (A).

## Wood Post Holdbacks

Available in 2-1/2", 4", or 6" projections with smooth or fluted 2" diameter pole. Custom projections are available at no additional charge.

## Pedestal Holdbacks

Available in 2-1/2", 4", or 6" projections with smooth or fluted 2" diameter pole. Custom projections are available at no additional charge.

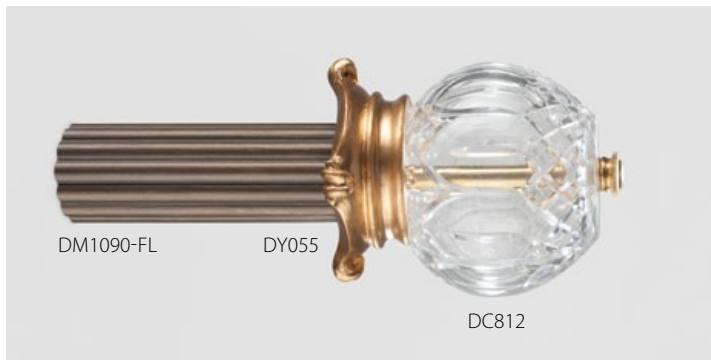

**Spring Flowers Crystal** (5"D) on **Chorus Base** (1-5/8"L x 4-1/2"H) in Gold Leaf-Traditional (B), shown on fluted **Wood Post Holdback** (P6") in Zinc (B).



**Starburst Crystal** (4"D) on **Antique Base** (2-1/4"L x 3"H) shown on **Pedestal Holdback** (2-5/8"L x 4-1/4"H - P6") with smooth pole in Antique Bronze (A).



# SWISSCRYSTAL Medallions



## Medallion Bases

To order, select (1) the medallion base from this page, and (2) the SwissCrystal from pages 23-30. Medallion bases may be used with a post or flush mount. Standard post projections are 2-1/2", 4" or 6" on 2" diameter smooth or fluted pole. Custom projections are available at no additional charge. *Please see price list for details*



DC807

**Heritage Crystal**  
(5-1/4"L x 4"H)  
shown on  
**Bard Base**  
(3-3/4"L x 7-3/4"H)  
in French Nobility (B).  
Shown as **Wood  
Post Holdback**  
(P4").

DM611X



DC810

**Rainbow Arc  
Crystal** (4"D)  
shown on  
**Bard Base**  
(3-3/4"L x 7-3/4"H) in  
Queensland Walnut  
with Gold  
Leaf-Antiqued  
Accents (C).  
Shown as  
**Flush Mount.**

DM611X



DC805

**Fascination  
Crystal** (4"D)  
shown on  
**Bravo Base**  
(1-1/4"L x 7-3/4"H) in  
Bronze Pewter (A).  
Shown as  
**Wood Post  
Holdback** (P4").

DM085



DC807

**Heritage Crystal**  
(5-1/2"L x 4"H)  
shown on  
**Bravo Base**  
(1-1/4"L x 7-3/4"H) in  
Creamy with Gold  
Leaf-Traditional  
Accents (C).  
Shown as  
**Flush Mount.**

DM085



DC804

**Empress Crystal**  
(4"D) shown on  
**Melody Base**  
(1"L x 8"H)  
in Silver Shimmer (A).  
Shown as  
**Wood Post  
Holdback** (P4").

DM094



DC814

**Timeless Crystal**  
(5"D) shown on  
**Melody Base**  
(1"L x 8"H) in  
Antique Bronze (A).  
Shown as  
**Flush Mount.**

DM094



DC816

**Windswept  
Crystal** (5"D)  
shown on  
**Minstrel Base**  
(3-3/4"L x 8"H)  
in Zinc (B).  
Shown on  
**Wood Post  
Holdback** (P4").

DM596X



DC811

**Royal Egyptian  
Crystal** (6"D) on  
**Minstrel Base**  
(3-3/4"L x 8"H)  
shown in  
Queensland Walnut  
with Liquid Gold  
Leaf Accents (C).  
Shown as  
**Flush Mount.**

DM596X



# SWISSCRYSTAL-On-Iron

Contemporary 1-1/4" **iron rods** showcase hand-cut SwissCrystal Finials. Iron rods, rings, brackets and batons are available in **5 iron finishes** shown at right. All **5 SwissCrystal Finials** are available on **5 bases** shown here. The Standard Base is included in the finial price. All bases available in these **5 Décor Finishes only**: Zinc, Silver Shimmer, Antique Bronze, Urbane Bronze, Royal Red.

## IRON FINISHES



DC815

**Twinkle Crystal** (1-1/4"L x 3"H) on **Standard Base** (5/8"L x 2-5/8"H) in Urbane Bronze. Shown on iron rod in Metal Ore (D).



Metal Ore/DP935 (D)



Modern Gold/DP938 (D)



DC803

**Diamonds Crystal** (4"D) on **Allure Base** (2-1/4"L x 2-1/2"H) in Royal Red. Shown on iron rod in Modern Gold (D).



Oil Rubbed Bronze/DP934 (D)



Brushed Nickel/DP958 (E)



DC805

**Fascination Crystal** (4"D) on **Crown Base** (1-3/4"L x 2"H) in Antique Bronze. Shown on iron rod in Oil Rubbed Bronze (D).



Chrome/DP959 (F)

# SWISSCRYSTAL-ON-IRON



**Petite Elise Crystal** (3\"/>

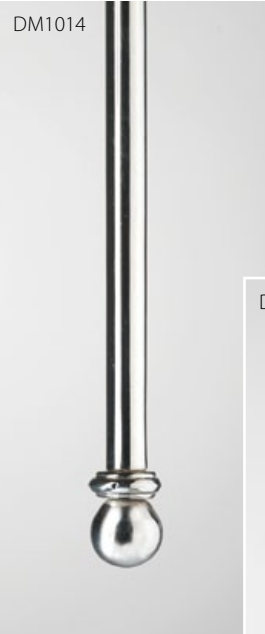

**Baton** (48\"/>



**Rainbow Arc Crystal** (4\"/>



## Iron U-Bend Holdbacks

3-1/2\"/>

**Fascination Crystal** (4\"/>

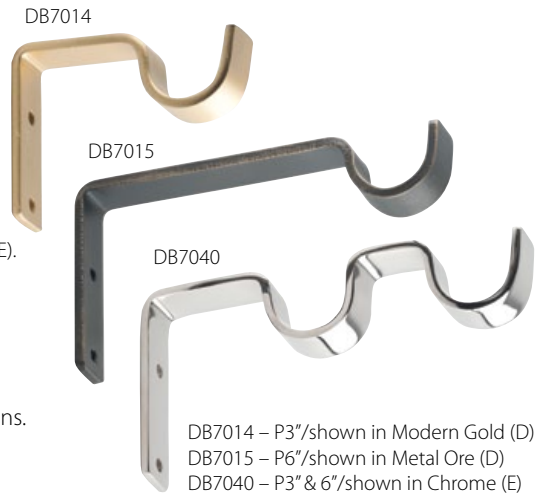

DB7014 – P3\"/>



## Iron Post Holdbacks

Available in 3\", 4\", or 6-1/2\"/>

**Twinkle Crystal** (1-1/4\"/>



Metal Ore (D)

Modern Gold (D)

Oil Rubbed Bronze (D)

Brushed Nickel (E)

Chrome (F)



# BOHEMIA CRYSTAL-On-Wood

Bohemia Crystals for 1-3/8" poles.



DC778-1

**Gem Crystal** (1-1/4"L x 2-3/8"H) shown in Queensland Walnut with Silver Leaf-Polished Accents (C).



DC790-1

**Rondure Crystal** (3/4"L x 2"H) shown in French Nobility (B).



Bohemia Crystals for 1-3/8", 2" and 2-1/4" poles. Also available as Holdbacks.



DC782-2

**Brilliant Block Crystal** (2-7/8"L x 2-3/4"H) shown in Italian Walnut with Gold Leaf-Polished Accents (C).



DC772-2

**Crescent Crystal** (2-3/4"L x 2-3/8"H) shown in English Bronze (A).



DC777-2

**Dazzle Crystal** (3"L x 2-3/4"H) shown in Black Embers (B).



DC787-2

**Exquisite Crystal** (3-1/2"L x 2"H) shown in Clouds (B).



DC776-2

**Facet Crystal** (2-3/8"L x 3-1/8"H) shown in Italian Gold (B).



DC771-2

**Glisten Crystal** (2-3/8"L x 2-1/4"H) shown in Paris Rain (B).

# BOHEMIA CRYSTAL-On-Wood

Bohemia Crystals for 1-3/8", 2" and 2-1/4" poles. Also available as Holdbacks.

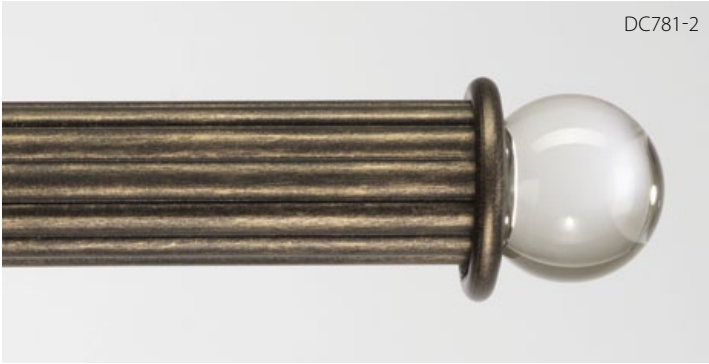

DC781-2

**Orb Crystal** (2-1/8"L x 2-3/8"H) shown in Antique Gold (A).



DC779-2

**Prism Crystal** (1-1/2"L x 3-1/8"H) shown in Mahogany with Gold Leaf-Polished Accents (C).



DC773-2

**Shimmer Crystal** (2-3/4"L x 2-3/8"H) shown in Queensland Walnut with Liquid Gold Leaf Accents (C).



DC774-2

**Solitaire Crystal** (2"L x 2-3/4"H) shown in White Dove (A).



DC775-2

**Sparkle Crystal** (2-3/4"L x 2-1/2"H) shown in Rusty (A).



DC791-2

**Stacked Crystal** (3-5/8"L x 3-5/8"H) shown in Copper Glimmer (A).



DC788-2

**Vortex Crystal** (3-1/2"L x 2"H) shown in Chateau (B).



DC792-2

**Whirl Crystal** (3-3/4"L x 3-1/4"H) shown in Creamy (B).

# INLAY DESIGNS



DESIGN ART BY ORION  
CELEBRATE YOUR CREATIVITY...

with 10 uniquely rich Inlay Designs.

All items are offered in 58 Hand-Painted Décor Finishes,  
our Dual Finish System with 11 Accent Finishes , or in Custom Colors.



# INLAY Designs



## What is an Inlay Design?

Exquisite Inlay furniture dates back to the Pharaohs of Egypt. Beautiful Inlay designs are carved into the main wood piece, such as the cabinet shown left, and then filled in with exotic wood veneers.

Our 10 Inlay designs, hand-made in much the same fashion, are offered in 2-1/4" & 3" smooth round and traversing poles, with coordinating finials, brackets and rings.



Continuous Patterns Run End to End

**Continuous Pattern Inlay Designs** (shown below) run the entire length of the pole. Include design number and pole number from page 52 when ordering.



**Autumn Inlay** - DI502 - Shown in Mahogany with Gold Leaf-Traditional Accents (C).



**Cameo Inlay** - DI010 - Shown in Gold Leaf-Burnished with Black-Satin Accents (C).



**Harvest Inlay** - DI512 - Shown in Precious Metals with Gold Leaf-Antiqued Accents (C)



**Opera Inlay** - DI517 - Shown in Cherrywood with Gold Leaf-Traditional Accents (C).



**Sonnet Inlay** - DI529 - Shown in Italian Walnut with Gold Leaf-Traditional Accents (C).



### Continuous Pattern Splice:

Poles over 4 feet will have multiple Continuous Pattern panels spliced together.



# INLAY Designs

## Inlay Poles:

Inlay pole designs are available in Continuous Pattern and Repeat Pattern styles. Repeat Patterns come in 4 foot sections with a 12" pattern repeat and are centered in the pole. Depending on the pole length, Repeat Patterns may run from end to end on the pole, or there may be spaces on each end without Inlay, as shown below.

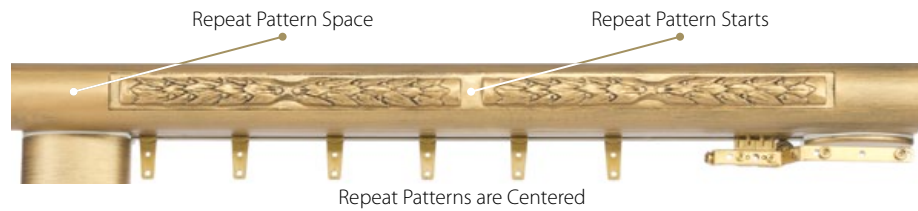

**Repeat Pattern Inlay Designs** (shown below) are centered in the pole. Include design number and pole number from page 52 when ordering.



**Garland Inlay** - DI508 - Shown in Paris Rain with Gold Leaf-Burnished Accents (C).



**Ornament Inlay** - DI006 - Shown in Ebony with Gold Leaf-Burnished Accents (C).



**Paisley Inlay** - DI005 - Shown in Vintage Gold (B).



**Pinwheel Inlay** - DI008 - Shown in Cherrywood with Gold Leaf-Traditional Accents (C).



**Scroll Inlay** - DI009 - Shown in Aged Brass with Liquid Gold Leaf Accents (C).



## Repeat Pattern Splice:

Poles over 4 feet may have multiple Repeat Pattern panels spliced together.

# INLAY Decals

## What is a Decal?

Inlay Decals are small decorative emblems, designed to match each of the 10 Inlay Designs. Decals can only be placed on the finials, SwissCrystal base and bracket as shown below:

### Use Decals only on:



**Insignia Finial**



**Emblem Finial**



**Inlay Base**

Inlay base can be used with any SwissCrystal.



**Decal Bracket**

*Choose the decal to match your Inlay Pole Design.*



**Insignia Finial**  
with Scroll Decal shown  
in Urbane Bronze with  
Gold Leaf-Burnished Accents (C).

**Scroll Decal**  
shown in Gold  
Leaf-Burnished (B).

**Scroll Inlay**  
shown in Urbane Bronze with  
Gold Leaf-Burnished Accents (C).

All Inlay Decals and Inlay Pole Designs can be finished in any of the 58 Décor Finishes, our Dual Finish System with 11 Accent Finishes , or your own custom finish.

# Autumn INLAY

## The 10 Inlay Designs: It's all about choices and creating your individual designs.

On the following pages, you'll see **Inlay Poles**, **finials** (matching or with Inlay Decals), **SwissCrystal Finials** (some on Inlay Base with Decal), as well as **rings** and **brackets** which include Inlay Designs. All are offered in 58 Décor Finishes, or our Dual Finish System with 11 Accent Finishes . *We want it to be a Designer's dream....*

**Autumn Decal**  
DI501



**Poles shown with Autumn Inlay, a continuous design pattern, which runs the length of pole.**

**Autumn Finial** DF500-3\*  
(7-3/4"L x 3-3/4"H)  
shown in Mahogany with  
Gold Leaf-Traditional Accents (C).

**Autumn Inlay** DI502  
shown in Mahogany with  
Gold Leaf-Traditional Accents (C)  
(continuous design pattern).

**Coronet Ring** DG544  
shown in Mahogany with  
Gold Leaf-Traditional Accents (C).



**Insignia Finial** (6-7/8"L x 4"H) with **Autumn Decal** shown in Superior Bronze with Gold Leaf-Polished Accents (C).



**Autumn Finial** (7-1/8"L x 3-3/4"H) shown in Zinc (B).

Examples of how the Autumn Inlay Decal and the Autumn Inlay can be used.



**Starburst Crystal** (4"D) on **Inlay Base** (3"L x 2-7/8"H) with **Autumn Decal** shown in Sage with Gold Leaf-Antiqued Accents (C).



**Heritage Crystal** (5-1/2"L x 4"H) on **Sonata Base** (2-1/2"L x 4-1/2"H) shown in Queensland Walnut with Gold Leaf-Antiqued Accents (C).

\*Finial shown with Adaptor.

# Cameo INLAY

Poles shown with Cameo Inlay, a continuous design pattern, which runs the length of pole.

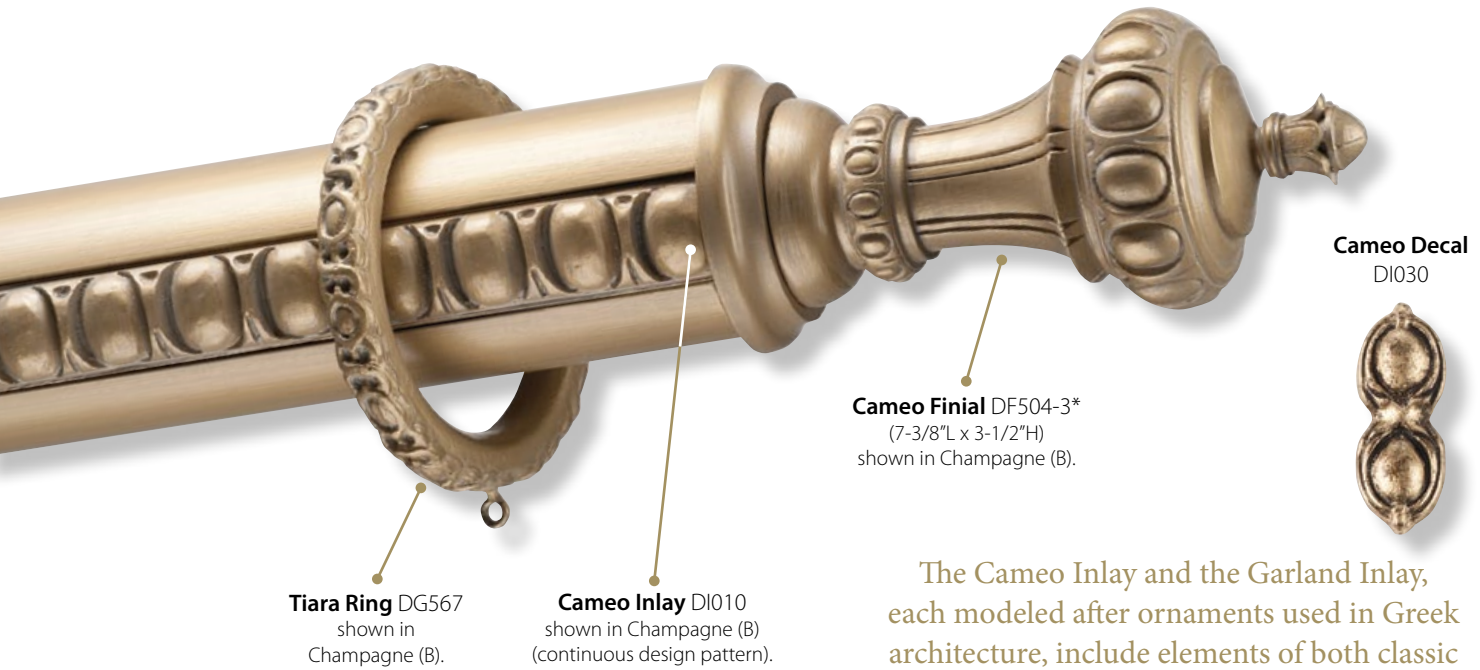

The Cameo Inlay and the Garland Inlay, each modeled after ornaments used in Greek architecture, include elements of both classic and modern décor -- both perfect for today's homes.



**Royal Orb Finial** (5-5/8"L x 3-3/4"H) shown in English Bronze (A).



**Insignia Finial** (6-7/8"L x 4"H) with **Cameo Decal** shown in Silver Leaf-Burnished (B).

Examples of ways the Cameo Inlay Decal and the Cameo Inlay can be used.

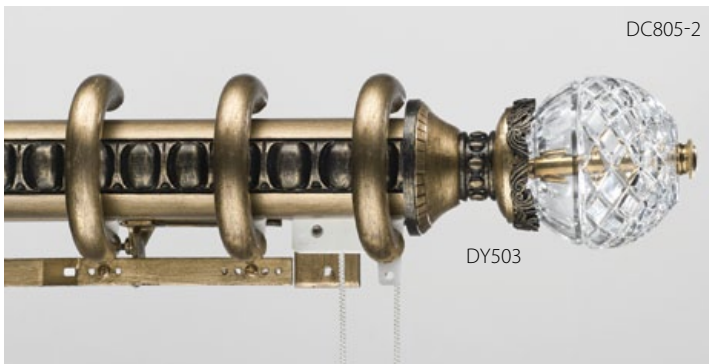

**Fascination Crystal** (4"D) on **Caprice Base** (3"L x 3"H) shown in Gold Leaf-Burnished with Black-Satin Accents (C).



**Cameo Finial** (6-3/4"L x 3-1/2"H) shown in Queensland Walnut with Gold Leaf-Traditional Accents (C).

\*Finial shown with Adaptor.

Poles shown with **Garland Inlay**, a repeat design pattern, which is centered in the pole.

# Garland INLAY



**Heritage Crystal** (5-1/2"L x 4"H) on **Lyric Base** (3-3/8"L x 3"H) shown in Gold Leaf-Burnished (B).

DB555X



The **Inlay Bracket**, shown here with the **Garland Inlay** DI508 design, is hand-finished in Aged Brass with Gold Leaf-Burnished Accents (C).



**Timeless Crystal** (5"D) on **Inlay Base** (3-5/8"L x 2-7/8"H) with **Garland Decal** shown in French Nobility with Gold Leaf-Antiqued Accents (C).

DB057



**Poetry Bracket** shown in Sage (B).

**Garland Decal**  
DI507



DF509-2



**Garland Finial** (6-3/4"L x 3-3/4"H) on **Garland Inlay** motorized traversing pole shown in Rich Gold (B) (repeat design pattern).



**Concerto Rod-End** (3-1/8"L x 3-3/4"H) shown in Ebony with Gold Leaf-Tradition Accents (C).

DF509-2



**Garland Finial** (6-3/4"L x 3-3/4"H) shown in Paris Rain with Gold Leaf-Burnished Accents (C).

# Harvest INLAY

Poles shown with Harvest Inlay, a continuous design pattern, which runs the length of the pole.

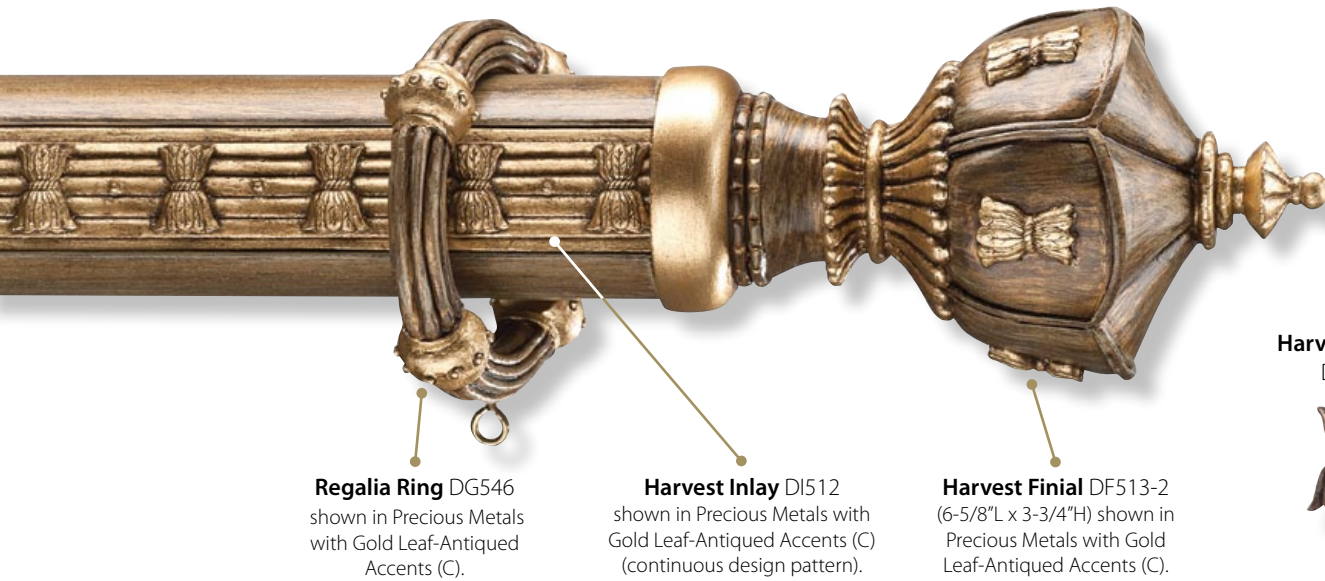

**Regalia Ring** DG546 shown in Precious Metals with Gold Leaf-Antiqued Accents (C).

**Harvest Inlay** DI512 shown in Precious Metals with Gold Leaf-Antiqued Accents (C) (continuous design pattern).

**Harvest Finial** DF513-2 (6-5/8"L x 3-3/4"H) shown in Precious Metals with Gold Leaf-Antiqued Accents (C).

**Harvest Decal** DI511



Celebrate your creativity with the warmth and natural beauty of the designs in the Harvest Inlay Collection.



DF513-2

**Harvest Finial** (6-5/8"L x 3-3/4"H) shown in Aged Chestnut with Gold Leaf-Polished Accents (C).



DC801-2

DY635X-2

**Aurora Crystal** (5"D) on **Inlay Base** (3-5/8"L x 2-7/8"H) with **Harvest Decal** shown in Copper Glimmer with Gold Leaf-Traditional Accents (C).

All finials, rings, decals, poles, etc. come in all 58 Décor Finishes, Dual Finish System with 11 Accent Finishes , or in Custom Colors.



DC803-2

DY510

**Diamonds Crystal** (4"D) on shown **Ballade Base** (3"L x 3-1/4"H) in Italian Gold with Gold Leaf-Traditional Accents (C).



DG546

**Regalia Ring** shown in Aged Chestnut (B); Precious Metals with Gold Leaf-Antiqued Accents (C).

Poles shown with Opera Inlay, a continuous design pattern, which runs the length of the pole.

# Opera INLAY



Opera Inlay, which includes elements of the ancient Greek Acanthus leaf in its design, offers matching finials, rod-enders, rings, & brackets, all in your choice of finishes.



**Overture Rod-Ender** (3-3/4"L x 4-1/4"H) shown in Paris Rain (B).



**Starburst Crystal** (4"D) on **Song Base** (3-1/8"L x 3"H) shown in Queensland Walnut with Gold Leaf-Antiqued Accents (C).

Examples of ways the Opera Inlay can be used.



**Opera Finial** (7-1/8"L x 3-1/4"H) shown in Creamy (B).

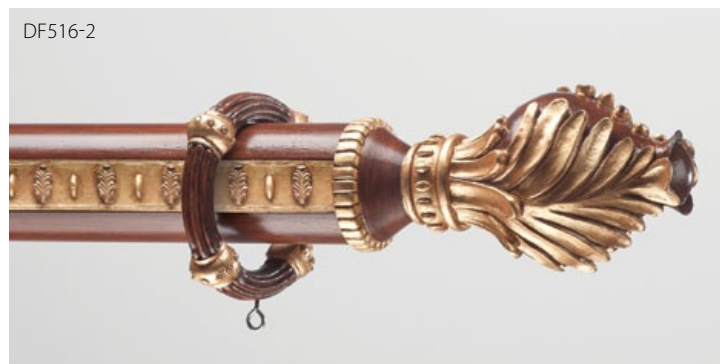

**Opera Finial** (6-1/2"L x 3-1/4"H) shown in Cherrywood with Gold Leaf-Traditional Accents (C).

\*Finial shown with Adaptor.

# Ornament INLAY

Poles shown with Ornament Inlay, a repeat design pattern, which is centered in the pole.

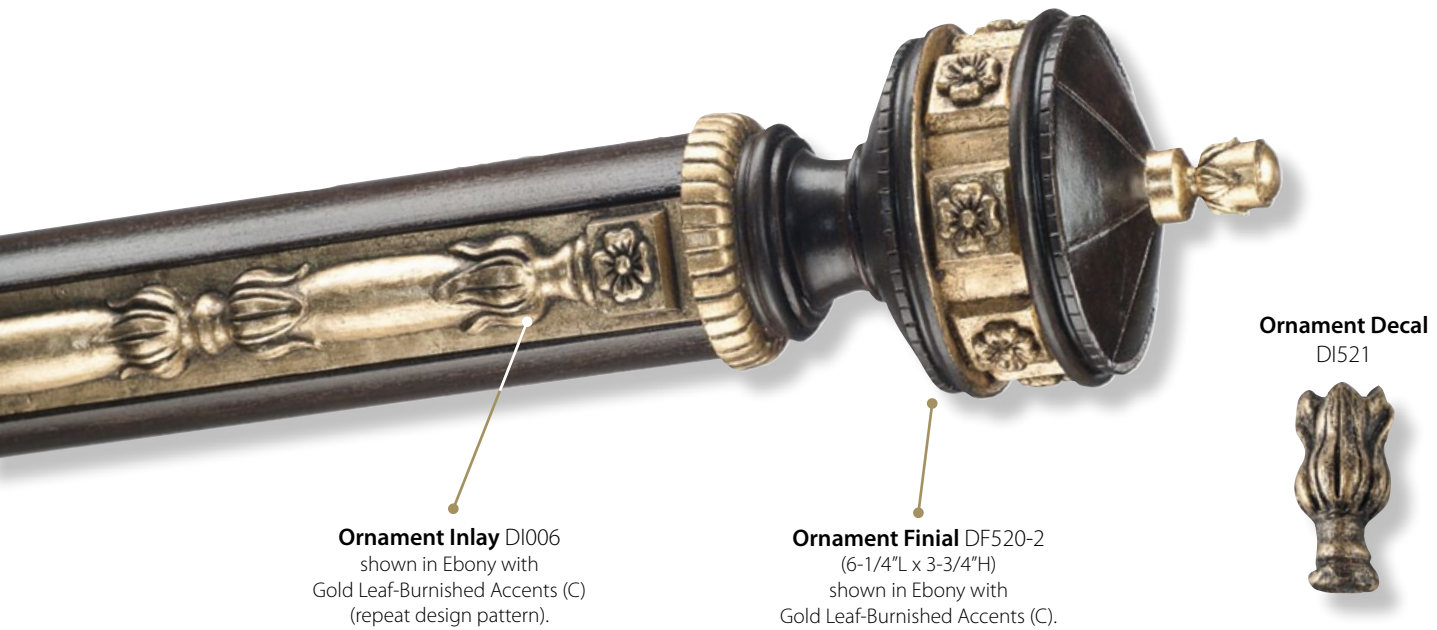

The Ornament Inlay Collection, modeled on an exquisite antique mirror, offers many beautiful design options.

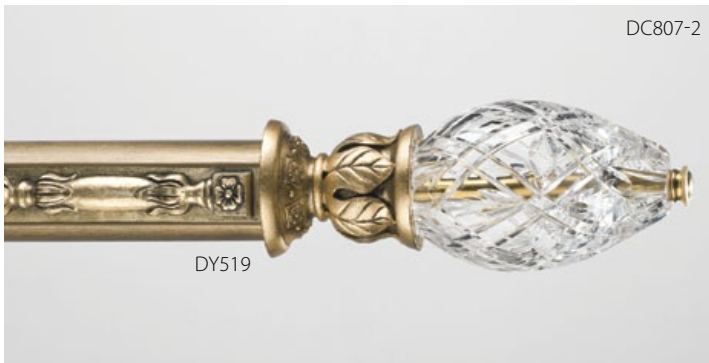

**Heritage Crystal** (5-1/2"L x 4"H) on **Lyric Base** (3-3/8"L x 3"H) in Gold Leaf-Burnished (B).



**Aurora Crystal** (5"D) on **Lyric Base** (3-3/8"L x 3"H) shown in Vintage Gold with Gold Leaf-Antiqued Accents (C).

Examples of how the Ornament Inlay can be used.



**Ornament Finial** (6-7/8"L x 3-3/4"H) shown in Bronze Pewter (A).



**Overture Rod-End** (3-3/4"L x 4-1/4"H) shown in Creamy with Gold Leaf-Antiqued Accents (C).

\*Finial shown with Adaptor.



Poles shown with Paisley Inlay, a repeat design pattern, which is centered in the pole.

# Paisley INLAY



**Paisley Finial** DF522-3\*  
(7-3/8"L x 3-3/4"H)  
shown in Italian Walnut with  
Gold Leaf-Antiqued Accents (C).

DG062

**Paisley Ring**  
shown in Italian Walnut with Gold Leaf-Antiqued Accents (C);  
Silver Shimmer with Liquid Gold Leaf Accents (C).

**Paisley Decal**  
DI019

**Paisley Inlay** DI005  
shown in Italian Walnut with  
Gold Leaf-Antiqued Accents (C)  
(repeat design pattern).

The Paisley Inlay design with its romantic curves, is modeled after the fleur-de-lys, the royal symbol of French kings.



DF107-2\*

**Festival Finial** (4-1/4"L x 2-3/8"H) in Hammered Silver  
with Silver Leaf-Burnished Accents (C).



DC805-2

DY072

**Fascination Crystal** (4") on **Antique Base** (2-1/4"L x 3"H)  
shown in Gold Leaf-Antiqued (B) with pole in Mahogany (B).

Examples of how the Paisley Inlay can be used.



DC808-3

DY041

**Old Pinwheel Crystal** (6"D) on **Prelude Base** (4-3/8"L x 4-1/4"H)  
shown in Gold Leaf-Burnished (B).



DF522-2

**Paisley Finial** (6-3/4"L x 3-3/4"H) shown in Vintage Gold (B).

\*Finial shown with Adaptor.

# Pinwheel INLAY

Poles shown with Pinwheel Inlay, a repeat design pattern, which is centered in the pole.

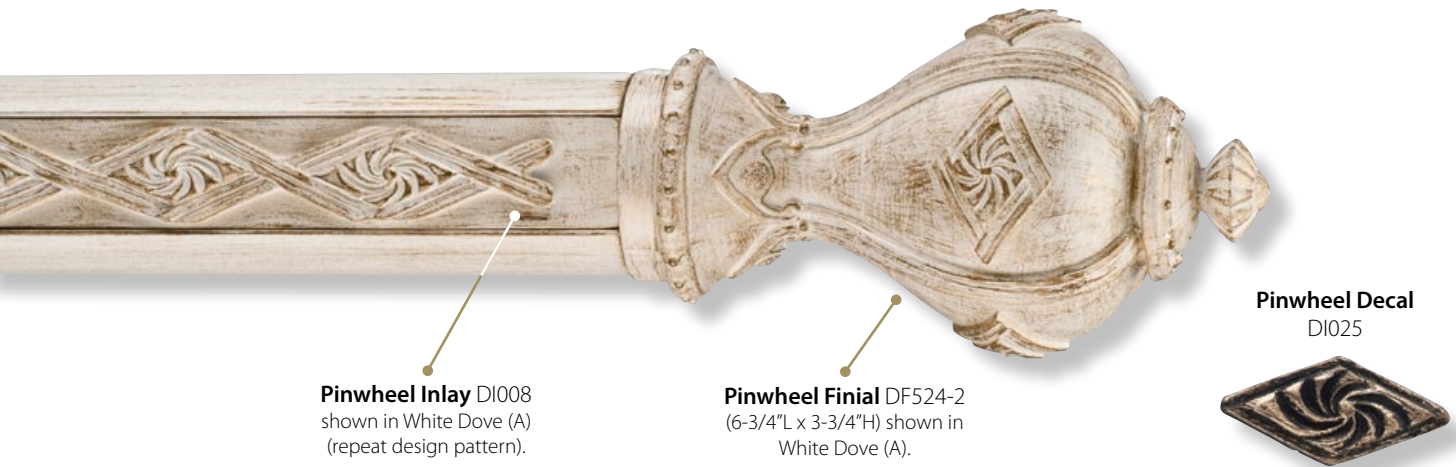

**Pinwheel Inlay** DI008 shown in White Dove (A) (repeat design pattern).

**Pinwheel Finial** DF524-2 (6-3/4"L x 3-3/4"H) shown in White Dove (A).

**Pinwheel Decal** DI025

Pinwheel Inlay is designed to reflect the beauty of the pinwheel crystal pattern, shown in Old Pinwheel Crystal (bottom left).



DF404-2

**Finery Finial** (5-1/4"L x 3-5/8"H) shown in Zinc with Gold Leaf-Burnished Accents (C).



DF633X-2

**Emblem Finial** (6-3/4"H x 4-1/4"H) with **Pinwheel Decal** shown in Hickory with Black-Satin Accents (C).



DF100-2\*

**Lattice Finial** (4-5/8"L x 3-1/8"H) shown in Italian Walnut with Gold Leaf-Antiqued Accents (C).



DF524-3\*

**Pinwheel Finial** (7-3/8"L x 3-3/4"H) shown in Aged Chestnut with Gold Leaf-Antiqued Accents (C).



DC808-3

DY407

**Old Pinwheel Crystal** (6"D) on **Music Base** (2-3/8"L x 3-3/8"H) shown in Gold Leaf-Antiqued (B).



DC812-2

DY635X-2

**Spring Flowers Crystal** (5"D) on **Inlay Base** (3-5/8"L x 2-7/8"H) with **Pinwheel Decal** shown in Cherrywood with Gold Leaf-Antiqued Accents (C).

\*Finial shown with Adaptor.

Poles shown with Scroll Inlay, a repeat design pattern, which is centered in the pole.

# Scroll INLAY

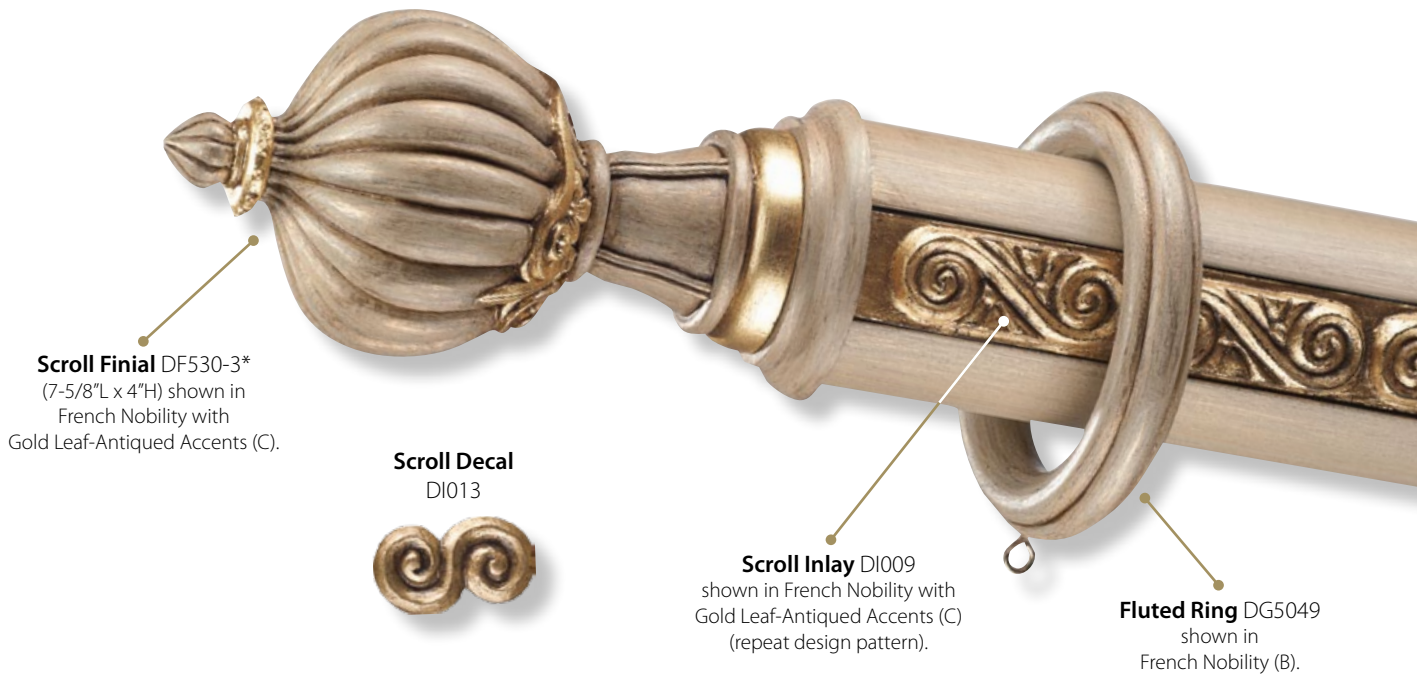

The Scroll Inlay, based on ancient Greek architectural designs, includes classic elements which fit any style of décor.



**Spring Flowers Crystal** (5"D) on **Inlay Base** (4-1/4"L x 3-3/8"H) with **Scroll Decal** shown in French Nobility with Gold Leaf-Antiqued Accents (C).

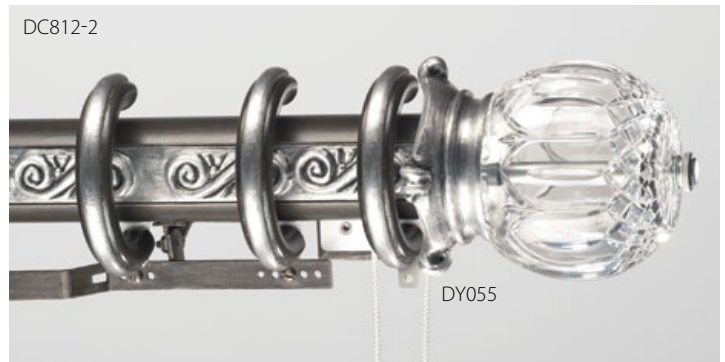

**Spring Flowers Crystal** (5"D) on **Chorus Base** (1-5/8"L x 4-1/2"H) shown in Steel with Silver Leaf-Burnished Accents (C).

Examples of how the Scroll Inlay Decal and the Scroll Inlay can be used.



**Scroll Finial** (7"L x 4"H) shown in Clouds (B).



**Rainbow Arc Crystal** (4"D) on **Medley Base** (3-1/8"L x 3-1/2"H) shown in Aged Brass with Liquid Gold Leaf Accents (C).

\*Finial shown with Adaptor.

# Sonnet INLAY

Poles shown with Sonnet Inlay, a continuous design pattern, which runs the length of the pole.

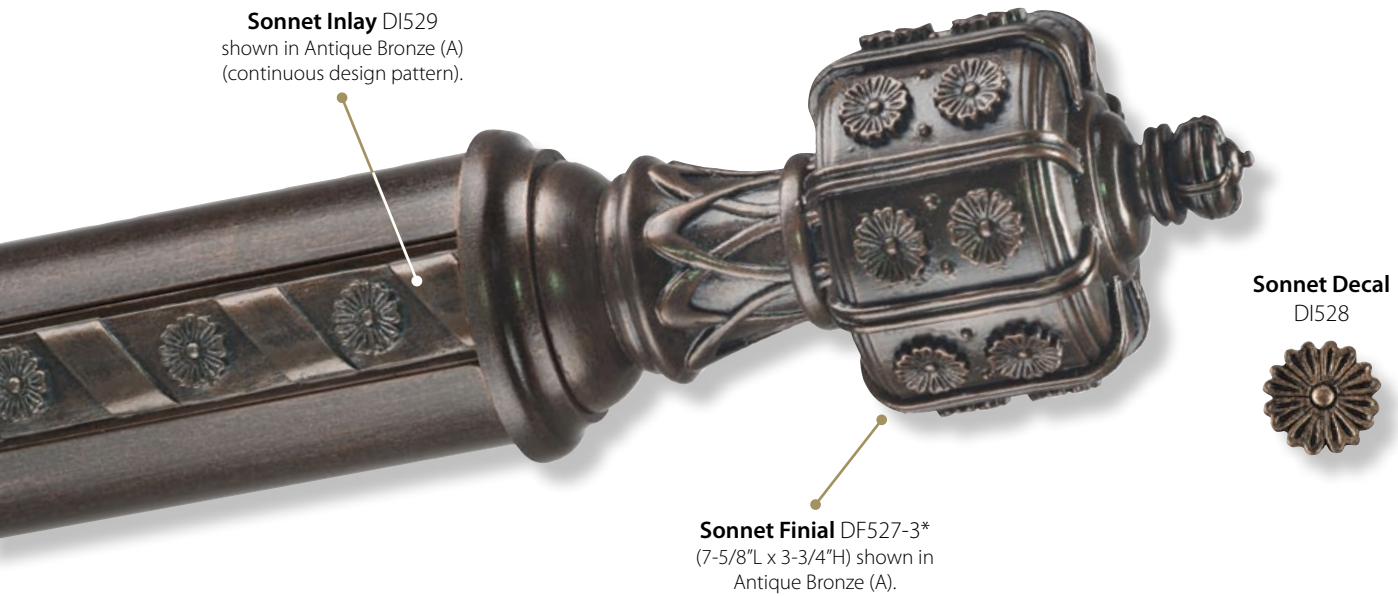

Depending on the Finial, SwissCrystal Base, Rod-Ender or fabric chosen to go with it, the Sonnet Inlay design can bring either a floral motif or a Victorian look to drapes.



**Heritage Crystal** (5-1/2"L x 4"H) on **Orchestra Base** (2"L x 3-7/8"H) shown in Gold Leaf-Traditional (B).



**Sonnet Finial** (7"L x 3-3/4"H) shown in Queensland Walnut with Gold Leaf-Traditional Accents (C).

Examples of how the Sonnet Inlay Decal and the Sonnet Inlay can be used.



**Verse Rod-Ender** (3-3/4"L x 4-3/8"H) shown in Aged Brass with Gold Leaf-Burnished Accents (C).



**Windswept Crystal** (5"D) on **Inlay Base** (3-5/8"L x 2-7/8"H) with **Sonnet Decal** shown in Champagne with Gold Leaf-Polished Accents (C).

\*Finial shown with Adaptor.

# WOOD POLES

Wood Pole Splice



## Wood Poles:

The maximum continuous length for wood poles is 16' (192"). Available spliced for standard delivery (maximum length is 8'10" (106") or continuous through truck delivery (please contact customer service for details). Manual or motorized traversing poles are available for poles over 2" in diameter, and up to 30' (360") in length (see pages 53-56). *Please see price list for details.*

**Smooth, Fluted, Rope:** Available in 58 Décor Finishes, or Custom Colors.

Smooth Pole Sizes:  $\frac{1-3/8"}{DSM-138}$   $\frac{2"}{DSM-200}$   $\frac{2-1/4"}{DSM-225}$   $\frac{3"}{DSM-300}$



Smooth Pole shown in Copper Glimmer (B).

Fluted Pole Sizes:  $\frac{1-3/8"}{DFL-138}$   $\frac{2"}{DFL-200}$   $\frac{2-1/4"}{DFL-225}$   $\frac{3"}{DFL-300}$



Fluted Pole shown in Gold Leaf-Antiqued (B).

Rope Pole Sizes:  $\frac{1-3/8"}{DRP-138}$   $\frac{2"}{DRP-200}$   $\frac{2-1/4"}{DRP-225}$   $\frac{3"}{DRP-300}$



Rope Pole shown in Antique Copper (A).

**Inlay Poles:** Available in 58 Décor Finishes, Dual Finish System with 11 Accent Finishes , or Custom Colors.

Inlay Pole Sizes:  $\frac{2-1/4"}{DIN-225}$   $\frac{3"}{DIN-300}$



Autumn Inlay Pole shown in Mahogany with Gold Leaf-Traditional Accents (C).

Inlay poles are offered in 10 Inlay Designs (see pages 39-40). Please include pole number and design number when ordering.

# MANUAL Traversing Poles

**Pole Styles:** Smooth, Fluted, Rope: 2", 2-1/4", 3"; Inlay: 2-1/4", 3"

DTSM-S



**Single:** Smooth Traversing Pole in Antique Copper (A) • Shown Center Open

DTFL-S



**Single:** Fluted Traversing Pole in Antique Copper (A) • Shown Center Open

DTRP-S



**Single:** Rope Traversing Pole in Antique Copper (A) • Shown Left Stack

DTIN-S



**Single:** Inlay Traversing Pole in Antique Copper (A) • Shown Center Open

DTIN-D



**Double:** Front Inlay Traversing Pole • Rear Smooth Traversing Pole • Shown Center Open  
Set shown in Zinc with Gold Leaf-Burnished Accents (C)

DRTIN-D



**Double:** Stationary Front Inlay Pole • Shown with rings  
Smooth Traversing Rear Pole • Shown Stack Right • Set shown in Old Black (A)

## Pole Styles:

Front Poles -

Smooth, Fluted, Rope: 2", 2-1/4", 3"  
Inlay: 2-1/4", 3"

Back Poles (For Double) -

With Smooth, Fluted, or Rope Front:  
Matching 1-3/8" Poles  
With Inlay Front: 1-3/8" Smooth Pole

**Finished End Cap Included  
on All Back Rods**

Miter Return Available (307MR)

## Finishes:

For Front & Back Poles

Smooth, Fluted, Rope:

58 Décor Finishes,  
**plus** Custom Colors

For Front Inlay Poles Only:

58 Décor Finishes,  
Dual Finish System with  
11 Accent Finishes ,  
**plus** Custom Colors

## All Pole Lengths:

Up to 30 Feet for Traversing

## Sets Include:

Traversing Pole(s)

Heavy Duty Track(s) (See Colors Right)

Glides (Pinch Pleat or RippleFold)

Master Carriers\*

Cord, Cord Pulleys & Safety Pulley(s)\*

Drapery Return Hook(s)

End Brackets

Support Brackets

Finished End Caps (For Back Rods)

## Items Sold Separately:

Finials - pages 7-36

Batons - page 61

Rings Styles For:

Traversing Poles - page 54

Stationery Front Rod - page 62

**Rings Available on Front Poles Only:**

\*Please see price list for details.

# MANUAL Traversing Accessories



**Double Traversing Pole with Miter:**  
Front Pole Shown with Rings in White Dove (A).  
*Miter available for poles, manual traversing and motorized traversing.*

## Heavy Duty Brackets - Automatically Included in Sets

Wall Mount  
End Brackets



DB1048EBS  
**Single End Bracket**  
Vertical back plate

DB1049EBD  
**Double End Bracket**  
Vertical back plate

Wall Mount  
Support Brackets



DB1050SBS  
**Single Support Bracket**  
Horizontal back plate

DB1051SBD  
**Double Support Bracket**  
Horizontal back plate

Ceiling Mount  
End and Support Brackets



DB1052CBS  
**Single Bracket**  
Horizontal top plate

DB1053CBD  
**Double Bracket**  
Horizontal top plate

## Traversing Rings



Smooth Traversing Rings  
2", 2-1/4", 3"



Fluted Traversing Rings  
2", 2-1/4", 3"



Soprano Traversing Rings  
2", 2-1/4", 3"

## Heavy Duty Tracks, Pinch Pleat Glides & Return Hooks - Available in:



Gold



Antique Bronze



White



Black

## Pinch Pleat Glides & Return Hooks



TRGLP

## RippleFold Glides - Available in White



TRGLR



# MOTORIZED Traversing Poles

**Pole Styles:** Smooth, Fluted, Rope: 2", 2-1/4", 3"; Inlay: 2-1/4", 3"

DSTSM-S



**Single:** Smooth Traversing Pole in Rich Gold (B) • Shown Center Open

DSTFL-S



**Single:** Fluted Traversing Pole in Rich Gold (B) • Shown Left Stack

DSTRP-S



**Single:** Rope Traversing Pole in Rich Gold (B) • Shown Center Open

DSTIN-S



**Single:** Inlay Traversing Pole in Rich Gold (B) • Shown Left Stack

DSTSM-D



**Double:** Smooth Traversing Poles in Old Black (A) • Shown Right Stack

DRSTIN-D



**Double:** Stationary Front Inlay Pole • Shown with rings  
Smooth Traversing Rear Pole • Shown Right Stack • Set shown in Old Black (A)

## Pole Styles:

Front Poles -  
Smooth, Fluted, Rope: 2", 2-1/4", 3"  
Inlay: 2-1/4", 3"

Back Poles (For Double) -  
With Smooth, Fluted, or Rope Front:  
Matching 1-3/8" Poles  
With Inlay Front: 1-3/8" Smooth Pole

**Finished End Cap Included  
on All Back Rods**

Miter Return Available (307MR)

## Finishes:

For Front & Back Poles  
Smooth, Fluted, Rope:  
58 Décor Finishes,  
**plus** Custom Colors

For Front Inlay Poles Only:  
58 Décor Finishes,  
Dual Finish System with  
11 Accent Finishes ,  
**plus** Custom Colors

## All Pole Lengths:

Up to 30 Feet for Traversing

## Sets Include:

Traversing Pole(s)  
Heavy Duty Track(s) (See Page 54)  
Glides (Pinch Pleat or RippleFold)  
Master Carriers\*  
Motor(s)  
Finished Motor Sleeve(s) and  
Pulley Cover(s) (Match Fascia)  
Drapery Return Hook(s)  
End Brackets  
Support Brackets  
Finished End Caps (For Back Rods)

## Items Sold Separately:

Finials - pages 7-36  
Control Options - page 56  
Rings Styles For:  
Traversing Poles - page 56  
Stationery Front Rod - page 62  
**Rings Available on Front Poles Only:**

\*Please see price list for details.



# MOTORIZED Traversing Accessories

## Heavy Duty Brackets - Automatically Included in Sets

Wall Mount  
End Brackets



DB1048EBSS  
**Single  
End Bracket**  
Vertical back plate

DB1049EBSD  
**Double  
End Bracket**  
Vertical back plate

Wall Mount  
Support Brackets



DB1050SBSS  
**Single  
Support Bracket**  
Horizontal back plate

DB1051BSD  
**Double  
Support Bracket**  
Horizontal back plate

Ceiling Mount  
End & Support Brackets



DB1052CBSS  
**Single Bracket**  
Horizontal top plate

DB1053CBSD  
**Double Bracket**  
Horizontal top plate

## Traversing Rings



DGT5047  
Smooth Traversing Rings  
2", 2-1/4", 3"



DGT5049  
Fluted Traversing Rings  
2", 2-1/4", 3"



DGT059  
Soprano Traversing Rings  
2", 2-1/4", 3"

## Control Options

### DecoFlex Wire Free RTS Wall Switches

White Finish



**STSW1-WH**  
1 Track  
1 Channel

**STSW5-WH**  
1-5 Tracks  
5 Channels

Ivory Finish



**STSW1-IV**  
1 Track  
1 Channel

**STSW5-IV**  
1-5 Tracks  
5 Channels

Black Finish



**STSW1-BL**  
1 Track  
1 Channel

**STSW5-BL**  
1-5 Tracks  
5 Channels

### Telis 1 Chronis RTS

Silver Star Finish



**STRP1-SS**  
1 Track  
1 Channel

Pure Finish



**STRP1-PR**  
1 Track  
1 Channel

**STRP5-PR**  
1-5 Tracks  
5 Channels

### Telis RTS Remote Control

Silver Finish



**STRP1-SL**  
1 Track  
1 Channel

**STRP5-SL**  
1-5 Tracks  
5 Channels

Black Finish



**STRP1-BL**  
1 Track  
1 Channel

**STRP5-BL**  
1-5 Tracks  
5 Channels

## Why Motorization???

- Child Safety! No Cord.
- Already Assembled.
  - Easy to install.
  - Simple to operate.
- Operates Smoothly & Quietly.
  - Touch Motor System on Heavy Duty Motor 60e allows easy manual operation of drapes.
  - Standard motor available upon request.
- Works with Pinch Pleat or RippleFold.
- Weight Limit for Heavy Duty 60e Motor: 132 lbs.
- Can be Integrated into Home Automation Systems.
- More Controls Available Upon Request.

# ACCESSORIES

Design Art offers Brackets (standard, decorative and iron), Batons, Rings (standard, decorative and iron), Holdbacks, and Adornments in many sizes and styles to fulfill all your design desires.



# DESIGN ART BY ORION CELEBRATE YOUR CREATIVITY...

You create your own individual design look as you choose Brackets, Batons, Rings, Holdbacks and Adornments from the many styles offered by Design Art.

*And then, make your design unique by selecting your hand-painted finish from 58 Décor Finishes, Dual Finish System with 11 Accent Finishes , or your Custom Finish.*



# BRACKETS: Standard

Please see price list for all available sizes and product codes.



**\*European Bracket**

Top shown in Naturelle (A);  
Bottom shown in Soft Pewter (A).  
Available for 1-3/8", 2", 2-1/4" and 3" poles.



**American Bracket**

Top shown in Champagne (B);  
Bottom shown in Chateau (B).  
Available for 1-3/8", 2", 2-1/4" and 3" poles.



**\*Rectangle Bracket**

Top shown in Vintage Gold (B);  
Bottom shown in Creamy (B).  
Available for 2", 2-1/4" and 3" poles.

## Accent Brackets

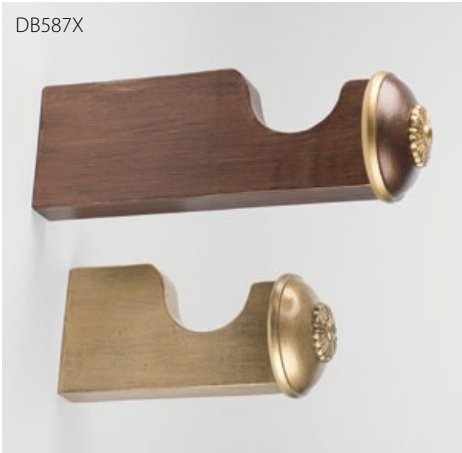

**\*Sonnet Bracket** Top shown in Copper Glimmer with Liquid Gold Leaf Accents (C);  
Bottom shown in Rich Gold (B).  
Available for 2", 2-1/4" and 3" poles.



**\*Decal Bracket** Top shown in Vintage Gold (B);  
Bottom shown in Ebony with Silver Leaf-Burnished Accents (C).  
Available for 2", 2-1/4" and 3" poles.  
Available in 10 Inlay Decal designs (see page 41).



**\*Opera Bracket** Top shown in Weathered Iron with Gold Leaf-Antiqued Accents (C);  
Bottom shown in Silver Shimmer (A).  
Available for 2", 2-1/4" and 3" poles.



**\*Sonnet Bracket** shown with **Cotillion Rod-Ender**.



**\*Opera Bracket** shown with **Opera Rod-Ender/Small**.

\*Indicates bracket has small back plate for use in tight spaces.

# BRACKETS: Decorative



**Doublet Bracket** Top shown in Ebony with Gold Leaf-Burnished Accents (C); Bottom shown Superior Bronze (A). Available for 2" and 2-1/4" poles.



**Inlay Bracket** Top shown in Aged Brass with Gold Leaf-Burnished Accents (C); Bottom shown in Italian Gold (B). Available for 2", 2-1/4" and 3" poles. Available in 10 Inlay Designs (See pages 39-40).



**Poetry Bracket** Top shown in Sage(B); Bottom shown in Burnt Gold with Gold Leaf-Burnished Accents (C). Available for 2" and 2-1/4" poles.



**Prose Bracket** Top shown in Monarch (A); Bottom shown in Superior Bronze with Liquid Gold Leaf Accents (C). Available for 1-3/8", 2" and 2-1/4" poles.



**Rhythm Bracket** Top shown in Queensland Walnut with Gold Leaf-Antiqued Accents (C); Bottom shown in Paris Rain (B). Available for 2" and 2-1/4" poles.

# BRACKETS: Socket

Please see price list for all available sizes and product codes.



DB535

DB535

DB5051



**Laurel Wreath Socket Bracket** shown in Weathered Iron (B). Available for 2", 2-1/4" and 3" poles.

**Laurel Wreath Socket Bracket** shown in Royal Red with Gold Leaf-Polished Accents (C). Available for 2", 2-1/4" and 3" poles.

**Standard Socket Bracket** shown in Antique Bronze (A). Available for 1-3/8", 2" and 2-1/4" poles.

# BATONS

# MORE...



DM1016



DM1020



DM5053



DM5071

**Iron Round Pole** shown in Black-Satin (A). 1/2"D with Iron Ball; Clip or Ring

**Iron Round Pole** shown in Antique Bronze (A). 1/2"D with Wood Handle; Ring or Clip

**Wood Round Pole** shown in Rich Gold (B). 1/2"D with Wood Handle; Clip Only

**Wood Round Pole** shown in Antique Gold (A). 5/8"D with Wood Handle; Clip Only



DB5050

**Swivel Elbow** shown in Black-Glossy (A); Pure White-Glossy (A). Available for 1-3/8", 2", and 2-1/4" poles.



DE5052

**End Cap** shown in Antique Bronze (A). Available for 1-3/8", 2", 2-1/4" and 3" poles.

**Batons.** Please see price list for lengths.

# WOOD RINGS



Pinwheel    Soprano    Paisley    Tiara    Coronet    Regalia    Fluted    Smooth    Twisted Iron    Hammered Iron  
Round Iron



DG5047-138    DG5047-300    DG5047-225

**Smooth Rings** (L-R) shown in Frosty Morn (A); Clouds (B); Cherrywood (B).



DG5049-138    DG5049-300    DG5049-225

**Fluted Rings** (L-R) shown in Precious Metals (B); French Nobility (B); Queensland Walnut with Gold Leaf-Burnished Accents (C).



DG544-300    DG544-225

**Coronet Rings** (L-R) shown in Mahogany with Gold Leaf-Traditional Accents (C); Sage (B).



DG546-300    DG546-225

**Regalia Rings** (L-R) shown in Aged Chestnut (B); Precious Metals with Gold Leaf-Antiqued Accents (C).



DG062-300    DG062-225

**Paisley Rings** (L-R) shown in Italian Walnut with Gold Leaf-Antiqued Accents (C); Silver Shimmer with Liquid Gold Leaf Accents (C).



DG059-138    DG059-300    DG059-225

**Soprano Rings** (L-R) shown in Old Rust with Liquid Gold Leaf Accents (C); Mahogany with Gold Leaf-Traditional Accents (C); Ebony with Gold Leaf-Traditional Accents (C).



DG063-300    DG063-225

**Pinwheel Rings** (L-R) shown in Aged Chestnut with Gold Leaf-Antiqued Accents (C); Italian Walnut with Gold Leaf-Antiqued Accents (C).



DG567-300    DG567-225

**Tiara Rings** (L-R) shown in Queensland Walnut with Gold Leaf-Traditional Accents (C); Weathered Iron (B).

# IRON RINGS

All iron rings and brackets are available in Group A & Group B finishes.  
(See Finishes pages 67-80.)



**Hammered Iron Rings** (L-R) shown in Soft Pewter (A); Rich Gold (B); Old Black (A).



**Round Iron Rings** (L-R) shown in Soft Pewter (A); Antique Bronze (A); Rich Gold (B).



**Twisted Iron Rings** (L-R) shown in Soft Pewter (A); Old Black (A); Rich Gold (B).

# IRON BRACKETS for Wood Poles

Please see price list for all available sizes and product codes.

DB1028-RND



**Bracket** shown in Old Black (A).

DB1028-RND



**Bracket** shown in Old Black (A).

DB1040-RND



**Bracket** shown in Old Black (A).

DB1040-RND



**Bracket** shown in Rich Gold (B).

DB1028HP-RND



**Bracket** shown in Soft Pewter (A).

DB1028HP-RND



**Bracket** shown in Soft Pewter (A).

DB1024DBWS-RND



**Double Bracket** shown in Rich Gold (B).

DB1040DBWS-RND



**Double Bracket** shown in Antique Bronze (A).

DB324-RND



**Socket Bracket Pair** shown in Rich Gold (B).

DB1010-RND



**Eyelet Bracket** shown in Soft Pewter (A).

DB1035-RND



**Ceiling Bracket** shown in Soft Pewter (A).

DB1036-RND



**Double Ceiling Bracket** shown in Antique Bronze (A).



Holdbacks are available in several design styles:

**Iron U-Bend, Iron Post, Wood Post, or Pedestal.**

Choose any Finial from pages 7-14 or Rod-Ender from pages 17-20.

# HOLDBACKS

## Iron U-Bend Holdbacks

3-1/2" projection



**Fruit Finial** (6-1/2"L x 3-1/2"H) shown on **Iron U-Bend Holdback** (P3-1/2") in Clouds (B).



**Sonnet Rod-Ender/Small** (1"L x 3-1/8"H) shown on **Iron U-Bend Holdback** (P3-1/2") in Paris Rain (B).



Iron Post, Wood Post, and Pedestal Holdbacks mount to the wall with a mounting plate.

## Iron Post Holdbacks

Available in 3", 4", or 6-1/2" projections.



**Bouquet Finial** (3-3/4"L x 3-1/4"H) shown on **Iron Post Holdback** (P4") in Weathered Iron (B).



**Sonnet Rod-Ender/Small** (1"L x 3-1/8"H) shown on **Iron Post Holdback** (P4") in Royal Red (A).

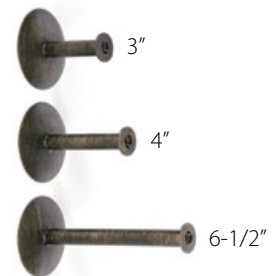

**Projections**

## Wood Post Holdbacks

Available in 2-1/2", 4", or 6" projections with smooth or fluted 2" diameter pole. Custom projections are available at no additional charge.



**Pineapple Finial** (6-1/4"L x 3-5/8"H) shown on smooth **Wood Post Holdback** (P2-1/2") in Queensland Walnut with Black-Satin Accents (C).



**Ballet Rod-Ender** (2-5/8"L x 3-1/2"H) shown on fluted **Wood Post Holdback** (P2-1/2") in Antique Bronze (A).



**Projections**

## Pedestal Holdbacks

Available in 2-1/2", 4", or 6" projections with smooth or fluted 2" diameter pole. Custom projections are available at no additional charge.



**Pineapple Finial** (6-1/4"L x 3-5/8"H) shown on **Pedestal Holdback** (2-1/2"L x 4-1/4"H - P4") with smooth pole in Queensland Walnut with Black-Satin Accents (C).



**Ballet Rod-Ender** (2-5/8"L x 3-1/2"H) shown on **Pedestal Holdback** (2-1/2"L x 4-1/4"H - P4") with smooth pole in Antique Bronze (A).



**Projections**

# ELEGANT Adornments

**CENTERPIECES** - Beautiful and elegant “sleeves”, designed to simply slide on 2” & 2-1/4” poles. Available in 58 Décor Finishes, Dual Finish System with 11 Accent Finishes [↗](#), plus custom finishes. Pole length? Up to you. Unique design possibilities? Definitely!



**Hallmark Centerpiece**  
(9”L x 4-1/8”H) shown in Precious Metals (B).



**Hallmark Centerpiece**  
(9”L x 4-1/8”H) shown in Ebony with Gold Leaf-Antiqued Accents (C).



**Signet Centerpiece**  
(9”L x 4-7/8”H) shown in Gold Leaf-Traditional (B).



**Signet Centerpiece**  
(9”L x 4-7/8”H) shown in French Nobility with Gold Leaf-Antiqued Accents (C).

# ELEGANT Adornments



DY510

Crystal Stair Newel Finial

**STAIR NEWELS** - Elegant Crystal Stair Newel Finials, such as this one shown in the traditional Pinwheel pattern, have graced the stair newel posts of fine homes for centuries. Create your own Crystal Stair Newel Finials by combining any SwissCrystal with any flush mountable SwissCrystal Base.

See price list for details.

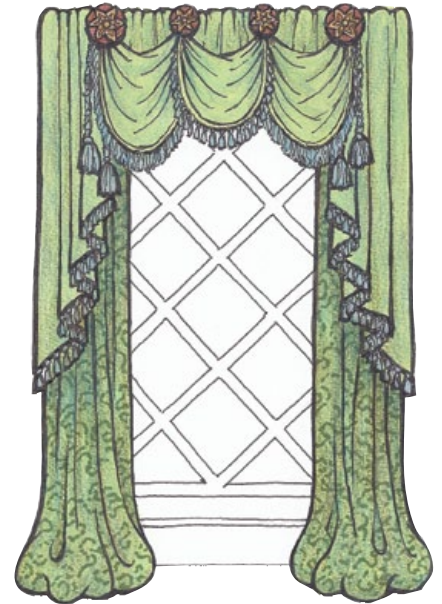

Combine the petite Beth Medallions with the larger Elizabeth Medallions to create a stunningly unique drapery design.

## MEDALLIONS



DY001

**Amanda Medallion** (1-1/2" x 5-3/4") shown in Burnt Gold (A). Flush Mount.



DM125

**Beth Medallion** (1-1/2" L x 4" H) shown as **Wood Post Holdback** (P4") in Hammered Silver with Silver Leaf-Polished Accents (C).



DM125

**Beth Medallion** (1-1/2" L x 4" H) shown in Italian Gold (B). Flush Mount.

All medallions are available as Flush Mount. All are also available as holdbacks with Iron Post, Iron U-Bend, Wood Post or Pedestal.

Available in 58 Décor Finishes, Dual Finish System with 11 Accent Finishes , or in Custom Colors. See price list for details.



DM002

**Elizabeth Medallion** (1-7/8" L x 5-3/4" H) shown as **Wood Post Holdback** (P4") in Precious Metals (B).



DM002

**Elizabeth Medallion** (1-7/8" L x 5-3/4" H) shown in Urbane Bronze with Gold Leaf-Burnished Accents (C). Flush Mount.

# FINISHES



# DESIGN ART BY ORION

## CELEBRATE YOUR CREATIVITY...

with 58 Hand-Painted Décor Finishes done just for you at Orion.

- 58 Hand-Painted Décor Finishes
- Dual Finish System with 11 Accent Finishes 
- Custom Palette Finishes

*All hand-painted for you at Orion. All Made in the USA.*

# FINISHES

CELEBRATE YOUR CREATIVITY...  
with Design Art's unique Dual Finish System.

Throughout our catalog you will see two items side-by-side: One is shown in a single Décor Finish (Groups A or B), and beside it is another with our Dual Finish System with 11 Accent Finishes (Groups A or B plus Group C). **It's your choice:** Elegantly simple Décor Finishes - Groups A or B, or exquisitely detailed with Accent Finishes - Group C.

Décor Finishes - A	Code / Finish	Page No.
Antique Bronze	DP902A	70
Antique Copper	DP910A	70
Antique Gold	DP906A	70
Black-Glossy	DP937A	70
Black-Satin	DP914A	70
Bronze Pewter	DP909A	70
Bronze Vecchio	DP915A	70
Brown	DP919A	70
Burnt Gold	DP925A	71
Cast Iron	DP912A	71
Copper Glimmer	DP918A	71
Copper Penny	DP961A	71
English Bronze	DP922A	71
Frosty Morn	DP924A	71
Hammered Silver	DP929A	71
Naturelle	DP903A	71
Old Black	DP901A	71
Old Rust	DP955A	72
Pure White-Glossy	DP936A	72
Pure White-Satin	DP933A	72
Royal Red	DP942A	72
Rusty	DP904A	72
Silver Shimmer	DP947A	72
Soft Pewter	DP913A	72
Steel	DP949A	72
Superior Bronze	DP950A	72
Urbane Bronze	DP951A	73
White Dove	DP954A	73

Décor Finishes - B	Code / Finish	Page No.
Aged Brass	DP956B	73
Aged Chestnut	DP905B	73
Black Embers	DP908B	73
Champagne	DP948B	73
Chateau	DP916B	73
Cherrywood	DP917B	73
Clouds	DP911B	74
Creamy	DP920B	74
Ebony	DP921B	74
French Nobility	DP923B	74
Gold Leaf-Antiqued	DP941B	74
Gold Leaf-Burnished	DP926B	74
Gold Leaf-Polished	DP927B	74
Gold Leaf-Traditional	DP928B	74
Hickory	DP930B	74
Italian Gold	DP931B	75
Italian Walnut	DP932B	75
Liquid Gold Leaf	DP963B	75
Mahogany	DP943B	75
Monarch	DP960B	75
Paris Rain	DP962B	75
Precious Metals	DP939B	75
Queensland Walnut	DP940B	75
Rich Gold	DP907B	75
Sage	DP946B	76
Silver Leaf-Burnished	DP944B	76
Silver Leaf-Polished	DP945B	76
Vintage Gold	DP952B	76
Weathered Iron	DP953B	76
Zinc	DP957B	76



Décor Finish

Accent Finish 

• Select one of our **58 Décor Finishes**, our **Dual Finish System with 11 Accent Finishes** , or **your own custom finish**. See price list for Accent Finish placement.

• There are **685 Finish** combinations possible -- great chances to create your own unique designs.



Accent Finishes - C	Code / Finish	Page No.
Antique Bronze	DP902C	77
Antique Gold	DP906C	78
Black-Satin	DP914C	78
Gold Leaf-Antiqued	DP941C	78
Gold Leaf-Burnished	DP926C	77
Gold Leaf-Polished	DP927C	78
Gold Leaf-Traditional	DP928C	77
Liquid Gold Leaf	DP963C	77
Silver Leaf-Burnished	DP944C	77
Silver Leaf-Polished	DP945C	77
Soft Pewter	DP913C	78

Group A : Warm and cool tones include bronze, black, silver, white...

# Décor FINISHES

Design Art by Orion offers 58 hand-painted Décor Finishes, plus our Dual Finish System with 11 Accent Finishes all designed to enhance your freedom of design.

Group A



Antique Bronze / DP902A



Antique Copper / DP910A



Antique Gold / DP906A



Black-Glossy / DP937A



Black-Satin / DP914A



Bronze Pewter / DP909A



Bronze Vecchio / DP915A

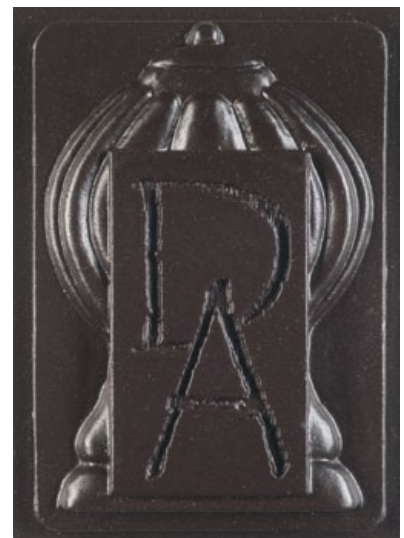

Brown / DP919A

Accent Finish

# Décor FINISHES

Group A



Burnt Gold / DP925A



Cast Iron / DP912A



Copper Glimmer / DP918A



Copper Penny / DP961A



English Bronze / DP922A



Frosty Morn / DP924A



Hammered Silver / DP929A



Naturelle / DP903A



Old Black / DP901A



# Décor FINISHES

Group A —————



Old Rust / DP955A



Pure White-Glossy / DP936A



Pure White-Satin / DP933A



Royal Red / DP942A



Rusty / DP904A



Silver Shimmer / DP947A



Soft Pewter / DP913A



Steel / DP949A



Superior Bronze / DP950A

Accent Finish

# Décor FINISHES

Group A



Urbane Bronze / DP951A



White Dove / DP954A

Group B: Warm tones include gold and silver leaf, wood grains...

Group B



Aged Brass / DP956B



Aged Chestnut / DP905B



Black Embers / DP908B



Champagne / DP948B



Chateau / DP916B



Cherrywood / DP917B

# Décor FINISHES

Group B: Warm tones include gold and silver leaf, wood grains...

Group B —————



Clouds / DP911B



Creamy / DP920B



Ebony / DP921B



French Nobility / DP923B



Gold Leaf-Antiqued / DP941B



Gold Leaf-Burnished / DP926B



Gold Leaf-Polished / DP927B



Gold Leaf-Traditional / DP928B



Hickory / DP930B

Accent Finish

# Décor FINISHES

Group B



Italian Gold / DP931B



Italian Walnut / DP932B



Liquid Gold Leaf / DP963B



Mahogany / DP943B



Monarch / DP960B



Paris Rain / DP962B



Precious Metals / DP939B



Queensland Walnut / DP940B



Rich Gold / DP907B

Accent Finish

# Décor FINISHES

Group B \_\_\_\_\_



Sage / DP946B



Silver Leaf-Burnished / DP944B 



Silver Leaf-Polished / DP945B 



Vintage Gold / DP952B



Weathered Iron / DP953B



Zinc / DP957B



**Uniquely Design Art--**  
58 Décor Finishes, plus our Dual  
Finish System with 11 Accent  
Finishes 



Accent Finish 

# Dual Finish System

Group C

Queensland Walnut/DP940B shown with each of the 11 Accent Finishes 

Gold Leaf-Traditional / DP928C



Queensland Walnut / DP940B +  
Gold Leaf-Traditional / DP928C

Antique Bronze / DP902C

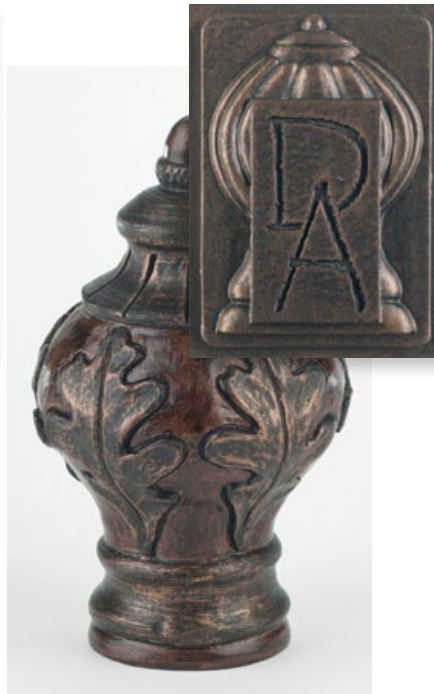

Queensland Walnut / DP940B +  
Antique Bronze / DP902C

Liquid Gold Leaf / DP963C



Queensland Walnut / DP940B +  
Liquid Gold Leaf / DP963C

Silver Leaf-Burnished / DP944C



Queensland Walnut / DP940B +  
Silver Leaf-Burnished / DP944C

Gold Leaf-Burnished / DP926C



Queensland Walnut / DP940B +  
Gold Leaf-Burnished / DP926C

Silver Leaf-Polished / DP945C

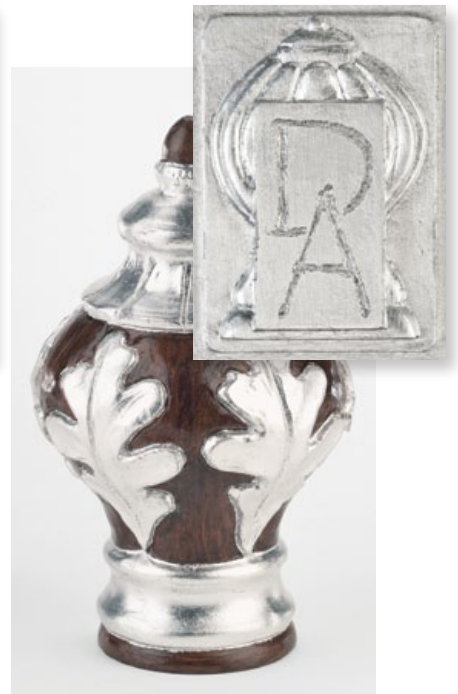

Queensland Walnut / DP940B +  
Silver Leaf-Polished / DP945C

# Dual Finish System

Queensland Walnut/DP940B shown with each of the 11 Accent Finishes 

Group C

Antique Gold / DP906C



Queensland Walnut / DP940B +  
Antique Gold / DP906C

Soft Pewter / DP913C



Queensland Walnut / DP940B +  
Soft Pewter / DP913C

Gold Leaf-Antiqued / DP941C



Queensland Walnut / DP940B +  
Gold Leaf-Antiqued / DP941C

Black-Satin / DP914C



Queensland Walnut / DP940B +  
Black-Satin / DP914C

Gold Leaf-Polished / DP927C



Queensland Walnut / DP940B +  
Gold Leaf-Polished / DP927C

# CUSTOM PALETTE



## Celebrate Your Creativity...

That's what Design Art is all about.  
And here is another way you can design  
with creative freedom.

**Match my color.** Choose a color from Benjamin Moore or Sherwin Williams, or send us a fabric or other color swatch to match. Let us know whether you prefer Gloss, Semi-Gloss or Matte. We'll send you a strike off for your approval.

### Or – Match my color and add Accents.

Here are some options:  
We can add Accents with any of our 11 Accent Finishes like those shown in the catalog on pages 77-78.

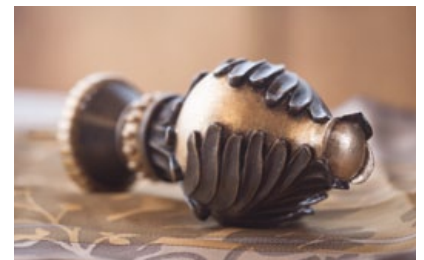

### Or – Match my color and add Highlights.

We can add Gold, Silver or Bronze Highlights--

\*To the carved areas of the piece

\*Over the entire piece.

*See price list for details.*

CHOOSE & MATCH





# FINISH Notes

## Painting Process

All Design Art items are hand painted after we receive your order. Items are painted together to ensure a consistent finish. Due to the nature of wood grain in the products and hand painting, some variations will occur. Finials, poles, brackets and rings each absorb paints and stains differently, making each order beautifully one-of-a-kind.

## Finishes

The finishes presented in this catalog are photographic and lithographic reproductions, and as such may not accurately reflect the true depth and tone of our finishes. Please refer to our actual color swatch samples before ordering. Our color swatches show both smooth and detailed surfaces, indicating how the finish will look on various products.

## Topcoat Sheens

Design Art colors primarily use a Semi-Gloss or Gloss topcoat (see color swatches for actual sheen). We can change the topcoat finish to your choice of Glossy, Semi-Gloss, or Matte at no additional charge, to achieve your preferred sheen level.

## Touch-Up Paint

Touch-up paint is available upon request for an additional charge. Please see price list for details.

## Additional Painting Fees

We can repaint finished or unfinished hardware from other manufactures upon request. Please contact customer service for a quote.



**Celebrate Your Creativity...  
with any color**

# SELLING TOOLS

DS100



Displays to support and promote your sales.



Wall Displays (size: 32"W x 48"H) showing Rod-Enders, Finials, SwissCrystal Finials, Holdbacks, Medallions and Brackets in various color combinations. Included on some of the finials are samples of Inlays and Inlay Rings.

DS200



The TableTopper (30"W x 17"H x 4"D) displays 5 samples; one SwissCrystal Finial, three Finials (one with an Inlay Design Ring, one with an Inlay Design Pole, and one without any additions), and a Rod-End with a traversing track.

## Wall Displays and TableTopper

The Wall Display and TableTopper units are an excellent addition to any show room. They immediately promote the concept that full creativity is possible with Design Art. Each Wall Display contains samples of product showing size, style and color combinations, for example one of our finials with a Décor Finish and a choice of an Accent Finish. The Wall Display also includes examples of poles and rings with the Inlay design. And last but not least are samples of distinctly styled holdbacks, medallions and brackets.

DS300



**Diamonds Crystal** shown with **Antique Base** and a **Soprano Ring** in Rich Gold (B).



**Stanza Rod-End** shown in Queensland Walnut with Gold Leaf-Traditional Accents (C).



**Oak & Acorn Finial** shown in Sage (B).

## ShowOffs

This set of four ShowOffs is the perfect tool when you need to take samples on the road. Each comes with its own soft velvet protective sleeve with gold ties (7"W x 17-1/2"H). They make an elegant, portable presentation.



**Scroll Finial** with **Scroll Inlay Pole** shown in French Nobility with Gold Leaf-Antiqued Accents (C).

DS400



## Promotional Binder

It is not always easy to convey a color or visualize an idea, so to make things a little simpler we have assembled a sales binder. It contains a price list, full color 88 page catalog, which shows all of our product, and a 2-5/8"H x 1-7/8"W sample swatch of each beautiful finish.

DS500



The **Design Art by Orion Catalog Set** consists of:

- 88 page full color catalog
- Price list book and order forms for all products



The **Design Art by Orion Catalog Binder** consists of:

- 88 page full color catalog
- Price list book and order forms for all products
- 58 swatches showing unique Décor Finishes
- 5 swatches showing SwissCrystal-On-Iron Finishes



Individual **Finish Swatches** also available.

DS600

# INDEX

Batons	Item No.	Page No.
Iron Rod 1/2"D	DM1016	61
Swiss-On-Iron 1/2"D	DM1014	34
Iron Rod 1/2"D with Wood Handle	DM1020	61
Wood Rod 1/2" D	DM5053	61
Wood Rod 5/8"D	DM5071	61

Bohemia Crystal	Item No.	Page No.
Brilliant Block	DC782	35
Crescent	DC772	2, 22, <b>35</b>
Dazzle	DC777	35
Exquisite	DC787	35
Facet	DC776	35
Gem	DC778	35
Glisten	DC771	35
Orb	DC781	36
Prism	DC779	36
Rondure	DC790	35
Shimmer	DC773	36
Solitaire	DC774	36
Sparkle	DC775	36
Stacked	DC791	36
Vortex	DC788	36
Whirl	DC792	36

Brackets	Item No.	Page No.
American Bracket	DB5045	59
Decal Bracket	DB605X	41, <b>59</b>
Dbl Ceiling Bracket	DB1036	63
Dbl Metal Bracket	DB1024DBWS	63
Dbl Metal Bracket with Support	DB1040DBWS	63
Doublet Bracket	DB028	58, <b>60</b>
European Bracket	DB5046	59
Eyelet Bracket	DB1010	63
Horiz Plate Bracket	DB1028HP	63
Inlay Bracket	DB555X	38, 44, <b>60</b>
Laurel Wreath Socket Bracket Pair	DB535	57, <b>61</b>
Metal Socket Pair	DB324	63
Opera Bracket	DB586X	59
Poetry Bracket	DB057	38, 44, <b>60</b>
Prose Bracket	DB056	2, 3, 57, <b>60</b>
Rectangle Bracket	DB626	59
Rhythm Bracket	DB117	60
Single Bracket	DB1028	63
Single Bracket	DB1040	63
Single Ceiling Brkt	DB1035	63
Sonnet Bracket	DB587X	57, <b>59</b>
Standard Socket Pair	DB5051	61

Centerpieces	Item No.	Page No.
Hallmark	DM604X	65
Signet	DM603X	65

Finials	Item No.	Page No.
Autumn Finial	DF500	6, <b>9</b> , 37, 42
Bouquet Finial	DF402	<b>7</b> , 64
Cameo Finial	DF504	5, <b>9</b> , 43, 53, 55
Elegance Finial	DF033	9
Eucalyptus Finial	DF569	9
Festival Finial	DF107	<b>7</b> , 48
Finery Finial	DF404	<b>10</b> , 49, 53
Fleur de Lys Finial	DF506	5, <b>10</b>
Fluted Ball Finial	DF069	10
Fruit Finial	DF095	<b>10</b> , 64
Garland Finial	DF509	4, <b>11</b> , 44, 55
Harvest Finial	DF513	<b>11</b> , 45
Holiday Finial	DF106	7
Hospitality Finial	DF101	7
Keepsake Finial	DF096	8
Lattice Finial	DF100	<b>8</b> , 14, 49
Majesty Finial	DF102	8
Noble Finial	DF514	11
Oak & Acorn Finial	DF071	11
Opera Finial	DF516	1, <b>12</b> , 46
Ornament Finial	DF520	<b>12</b> , 37, 47
Paisley Finial	DF522	<b>12</b> , 48
Pineapple Finial	DF070	<b>12</b> , 64
Pinwheel Finial	DF524	3, <b>13</b> , 49
Prestige Finial	DF505	13
Royal Orb Finial	DF087	<b>13</b> , 43
Scroll Finial	DF530	2, <b>13</b> , 50
Sonnet Finial	DF527	<b>14</b> , 51
Tiara Finial	DF533	3, 5, <b>14</b>
Twirl Finial	DF089	<b>8</b> , 14

Holdbacks	Item No.	Page No.
Iron Post	DM1088	31, 34, <b>64</b>
Iron U-Bend	DM1087	31, 34, <b>64</b>
Pedestal	DM111	31, <b>64</b>
Wood Post	DM1090	31, <b>64</b>

Inlay Designs	Item No.	Page No.
Autumn Decal	DI501	<b>41</b> , 42
Autumn Finial	DF500	6, 9, 37, <b>42</b>
Autumn Inlay	DI502	<b>39</b> , 42, 52
Cameo Decal	DI030	<b>41</b> , 43
Cameo Finial	DF504	5, 9, <b>43</b> , 53, 55
Cameo Inlay	DI010	2, 22, 27, 35, <b>39</b> , 43, 53, 55
Decal Bracket	DB605X	41, <b>59</b>
Emblem Finial	DF633X	41, <b>49</b>
Garland Decal	DI507	<b>41</b> , 44
Garland Finial	DF509	4, 11, <b>44</b> , 55
Garland Inlay	DI508	2, 28, <b>40</b> , 44, 53, 55, 60
Harvest Decal	DI511	<b>41</b> , 45
Harvest Finial	DF513	11, <b>45</b>
Harvest Inlay	DI512	<b>39</b> , 45
Inlay Base	DY635X	41, 42, 44, 45, 49-51
Inlay Bracket	DB555X	38, 44, <b>60</b>
Inlay Pole	DIN	52
Insignia Finial	DF634X	41-43
Opera Decal	DI518	<b>41</b> , 46
Opera Finial	DF516	1, 12, <b>46</b>

Inlay Designs	Item No.	Page No.
Opera Inlay	DI517	<b>39</b> , 46
Ornament Decal	DI521	<b>41</b> , 47, 59
Ornament Finial	DF520	12, 37, <b>47</b>
Ornament Inlay	DI006	1, 37, <b>40</b> , 47
Paisley Decal	DI019	<b>41</b> , 48, 59
Paisley Finial	DF522	12, <b>48</b>
Paisley Inlay	DI005	2, 38, <b>40</b> , 48, 60
Pinwheel Decal	DI025	<b>41</b> , 49
Pinwheel Finial	DF524	3, 13, <b>49</b>
Pinwheel Inlay	DI008	2, 3, 25, <b>40</b> , 49, 53
Scroll Decal	DI013	<b>41</b> , 50
Scroll Finial	DF530	2, 13, <b>50</b>
Scroll Inlay	DI009	28, <b>40</b> , 50
Sonnet Decal	DI528	<b>41</b> , 51
Sonnet Finial	DF527	14, <b>51</b>
Sonnet Inlay	DI529	36, 37, <b>39</b> , 51

Manual Traversing	Item No.	Page No.
Double Fluted	DTFL-D	<b>53</b> , 54
Double Inlay	DTIN-D	49, <b>53</b>
Double Rope	DTRP-D	53
Double Smooth	DTSM-D	53
Frnt Pole / Rear Trav Fluted	DRTFL-D	53
Frnt Pole / Rear Trav Inlay	DRTIN-D	53
Frnt Pole / Rear Trav Rope	DRTRP-D	53
Frnt Pole / Rear Trav Smth	DRTSM-D	53
Single Fluted	DTFL-S	53
Single Inlay	DTIN-S	2, 28, 43, 46, 47, 49, 50, <b>53</b>
Single Rope	DTRP-S	53
Single Smooth	DTSM-S	20, 26, 28, <b>53</b>
Standard Trav Ring	DGT5047	2, 43, 53, <b>54</b> , 56
Fluted Trav Ring	DGT5049	26, 28, 50, 53, <b>54</b> , 56
Soprano Trav Ring	DGT059	20, 46, <b>54</b> , 56

Dbl Trav Ceiling Brkt	DB1053CBD	54
Dbl Trav End Brkt	DB1049EBD	54
Dbl Trav Support Brkt	DB1051SBD	54
Sngl Trav Ceiling Brkt	DB1052CBS	54
Sngl Trav End Brkt	DB1048EBS	54
Sngl Trav Support Brkt	DB1050SBS	54
Miter	307MR	54
Pinch Pleat Glides	TRGLP	54
RippleFold Glides	TRGLR	54

Medallions	Item No.	Page No.
Amanda Medallion	DY001	1, <b>66</b>
Beth Medallion	DM125	66
Elizabeth Medallion	DM002	2, <b>66</b>

More...	Item No.	Page No.
End Cap	DE5052	61
Swivel Elbow	DB5050	61

Motorized Traversing	Item No.	Page No.
Double Fluted	DSTFL-D	55
Double Inlay	DSTIN-D	55
Double Rope	DSTRP-D	55
Double Smooth	DSTSM-D	55

When multiple pages are listed, bold pages denote main information when applicable.

# INDEX

Motorized Traversing	Item No.	Page No.
Frt Pole / Rear Trav Fluted	DRSTFL-D	55
Frt Pole / Rear Trav Inlay	DRSTIN-D	55
Frt Pole / Rear Trav Rope	DRSTRP-D	55
Frt Pole / Rear Trav Smth	DRSTSM-D	55
Single Fluted	DSTFL-S	55
Single Inlay	DSTIN-S	44, <b>55</b>
Single Rope	DSTRP-S	55
Single Smooth	DSTSM-S	55
Standard Trav Ring	DGT5047	2, 43, 53, <b>54</b> , 56
Fluted Trav Ring	DGT5049	26, 28, 50, 53, <b>54</b> , 56
Soprano Trav Ring	DGT059	20, 46, <b>54</b> , 56
Dbl Trav Ceiling Brkt	DB1053CBSD	56
Dbl Trav End Brkt	DB1049EBS	56
Dbl Trav Support Brkt	DB1051SBS	56
Sngl Trav Ceiling Brkt	DB1052CBSS	56
Sngl Trav End Brkt	DB1048EBS	56
Sngl Trav Support Brkt	DB1050SBS	56
Miter	307MR	54
Pinch Pleat Glides	TRGLP	54
RippleFold Glides	TRGLR	54
DecoFlex Wall Blk 1 Track/1 Channel	STSW1-BL	56
DecoFlex Wall Blk 1-5 Track/5 Channel	STSW5-BL	56
DecoFlex Wall Ivory 1 Track/1 Channel	STSW1-IV	56
DecoFlex Wall Ivory 1-5 Track/5 Channel	STSW5-IV	56
DecoFlex Wall Wht 1 Track/1 Channel	STSW1-WH	56
DecoFlex Wall Wht 1-5 Track/5 Channel	STSW5-WH	56
Telis 1 Chronis RTS Remote Silver Star 1 Track /1 Channel	STRP1-SS	56
Telis RTS Remote Blk 1 Track/1 Channel	STRP1-BL	56
Telis RTS Remote Blk 1-5 Track/5 Channel	STRP5-BL	56
Telis RTS Remote Pure/1 Track/1 Channel	STRP1-PR	56
Telis RTS Remote Pure/1-5Track/5 Channel	STRP5-PR	56
Telis RTS Remote Silver/1 Track/1 Channel	STRP1-SL	56
Telis RTS Remote Silver/1-5Track/5 Channel	STRP5-SL	56
Poles	Item No.	Page No.
Fluted Pole	DFL	52
Inlay Pole	DIN	52
Rope Pole	DRP	52
Smooth Pole	DSM	52
Miter	307MR	54
Rings	Item No.	Page No.
Coronet Ring	DG544	9, 42, <b>62</b>
Fluted Ring	DG5049	9, 13, 24, 25, 35, 50, 53, 55, 57, <b>62</b>
Hammered Iron Ring	DG356	20, 62, 63

Rings	Item No.	Page No.
Paisley Ring	DG062	12, 27, 37, 48, <b>62</b>
Pinwheel Ring	DG063	3, 8, 13, 25, 38, 49, 50, <b>62</b>
Regalia Ring	DG546	11, 12, 14, 45, 46, <b>62</b>
Smooth Iron Ring	DG350	2, 9, 11, 14, 33, 34, 58, 62, <b>63</b>
Smooth Ring	DG5047	3, 7, 8, 10, 14, 23, 28, 35, 36, 57, <b>62</b>
Soprano Ring	DG059	2, 3, 4, 7, 11, 12, 23, 29, 37, 42, 44, 46, <b>62</b>
Tiara Ring	DG567	9, 14, 30, 43, 57, <b>62</b>
Twisted Iron Ring	DG351	8, 12, 62, <b>63</b> ,
Rod-Enders	Item No.	Page No.
Ballet Rod-Ende	DE049	2, 15, <b>18</b> , 53, 64
Blossom Rod-Ende	DE541	15, <b>17</b>
Concerto Rod-Ende	DE045	16, <b>18</b> , 44
Cotillion Rod-Ende	DE048	1, <b>18</b> , 59
Crest Rod-Ende	DE540X	17
Encore Rod-Ende	DE052	19
Michele Rod-Ende (Lg)	DE594X	19
Michele Rod-Ende (Sm)	DE598	19
Opera Rod-Ende (Lg)	DE580X	19
Opera Rod-Ende (Sm)	DE086	<b>19</b> , 59
Overture Rod-Ende	DE043	<b>19</b> , 46, 47
Petals Rod-Ende	DE525	17
Plume Rod-Ende	DE513	2, <b>17</b>
Polonaise Rod-Ende	DE042	3, <b>20</b>
Sonnet Rod-Ende (Lg)	DE581X	20
Sonnet Rod-Ende (Sm)	DE110	15, <b>20</b> , 64
Stanza Rod-Ende	DE053	18, <b>20</b>
Verse Rod-Ende	DE044	16, 18, <b>20</b> , 51
SwissCrystal	Item No.	Page No.
Aurora	DC801	3, 21, 25-28, 45, 47
Corona	DC802	25
Diamonds	DC803	21, 22, 26-28, 30, 33, 45
Empress	DC804	27, 32
Fascination	DC805	23, 24, 26-28, 32, 33, 43, 48
Halo	DC806	29, 31
Heritage	DC807	26, 27, 29, 32, 42, 44, 47, 51
Old Pinwheel	DC808	25, 27-29, 48, 49
Petite Elise	DC809	23, 25, 28, 29, 31, 34
Rainbow Arc	DC810	2, 21, 23, 24, 28, 30, 32, 34, 50
Royal Egyptian	DC811	24, 28, 30, 32
Spring Flowers	DC812	24-26, 31, 41, 49, 50
Starburst	DC813	22, 24, 25, 29, 31, 37, 42, 46
Timeless	DC814	1, 29, 30, 32, 44, 66
Twinkle	DC815	2, 21, 23, 27, 33, 34
Windswept	DC816	22, 25, 29, 32, 51

SwissCrystal Bases	Item No.	Page No.
Amanda Base	DY001	24
Antique Base	DY072	<b>27</b> , 31, 48
Aria Base	DY038	<b>24</b> , 31
Ballade Base	DY510	1, 21, <b>27</b> , 45, 66
Cadenza Base	DY599X	<b>24</b> , 30
Caprice Base	DY503	<b>27</b> , 43
Choir Base	DY080	25
Chorus Base	DY055	<b>25</b> , 31, 50
Dancer Base	DY612X	21, <b>27</b>
Diva Base	DM560	28
Grace Base	DY039	25
Grecian Base	DY099	23
Harmony Base	DY046	28
Lyric Base	DY519	<b>28</b> , 44, 47
Medley Base	DY526	21, <b>28</b> , 30, 50
Music Base	DY407	<b>25</b> , 49
Operetta Base	DY632	22, <b>29</b>
Opus Base	DY542X	26
Orchestra Base	DY054	<b>26</b> , 51
Prelude Base	DY041	3, 21, <b>29</b> , 48
Rhapsody Base	DY051	26
Sarah Base	DY003	<b>29</b> , 31
Serenade Base	DY090	2, <b>23</b> , 30
Sonata Base	DY409	<b>29</b> , 42
Song Base	DY515	22, <b>30</b> , 37, 46
Symphony Base	DY047	26
Tenor Base	DY532	30
SwissCrystal Medallions	Item No.	Page No.
Bard Base	DM611X	32
Bravo Base	DM085	32
Melody Base	DM094	32
Minstrel Base	DM596X	32
SwissCrystal-On-Iron	Item No.	Page No.
Allure Base	DY609X	<b>33</b> , 34
Baton	DM1014	34
Charm Base	DY575	34
Crown Base	DY610X	33
Diamonds SwissCrystal	DC803	22, <b>33</b>
Double Bracket	DB7040	34
Fascination SwissCrystal	DC805	<b>33</b> , 34
Iron Post Holdback	DM1088	34
Iron U-Bend Holdback	DM1087	34
Petite Elise SwissCrystal	DC809	34
Rainbow Arc SwissCrystal	DC810	34
Round Iron Ring	DG350	2, 33, <b>34</b>
Simplicity Base	DY577	34
Single Bracket - P3"	DB7014	34
Single Bracket - P6"	DB7015	34
Smooth Iron Rod	DIR	33, 34
Twinkle SwissCrystal	DC815	2, <b>33</b> , 34

When multiple pages are listed, bold pages denote main information when applicable.

# MEASUREMENTS

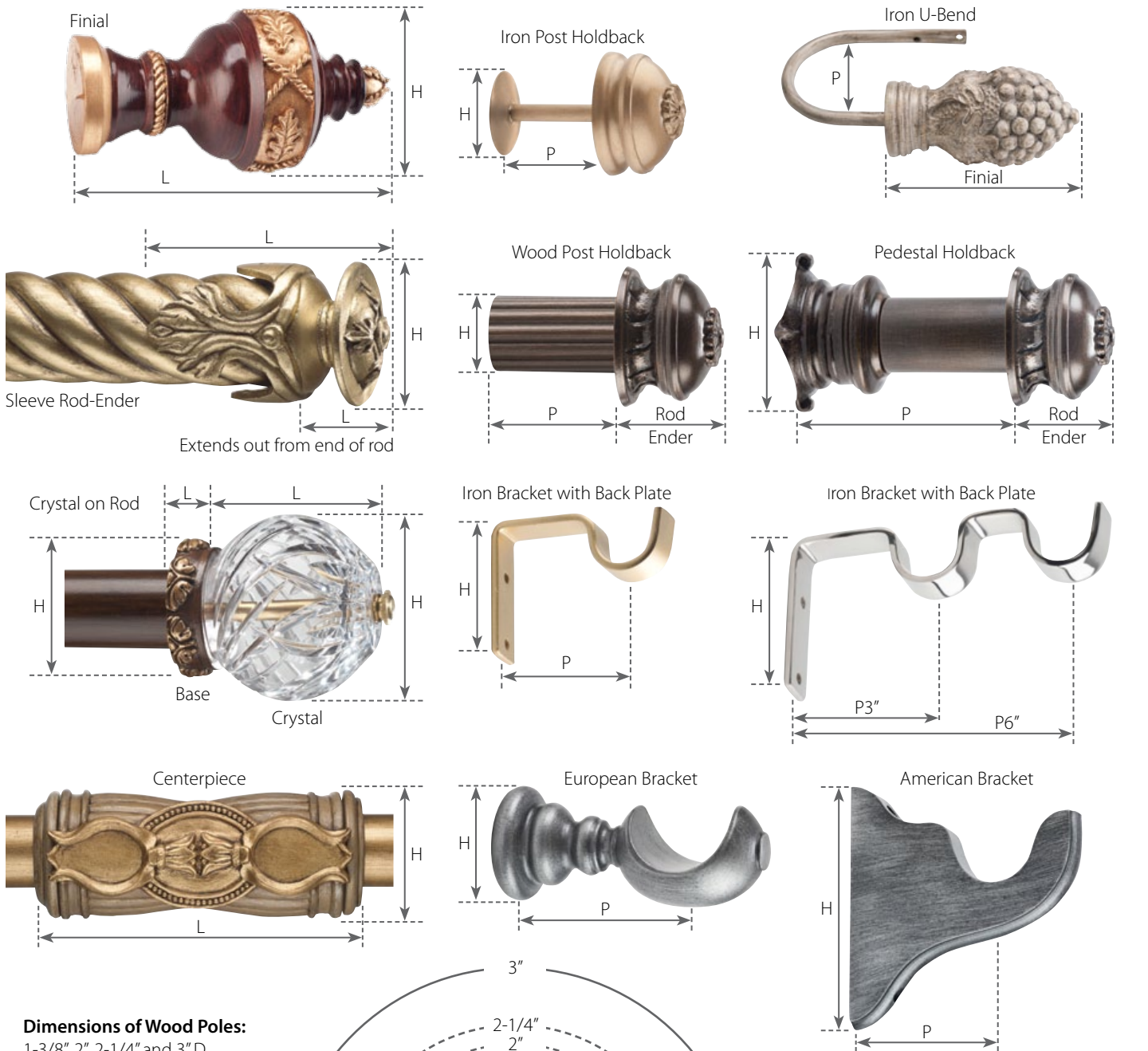

**Dimensions of Wood Poles:**

1-3/8", 2", 2-1/4" and 3" D.

**Dimension of Iron Rods:**

1-1/4"D

Table

H = Height

L = Length

P = Projection

ID = Inside Diameter

OD = Outside Diameter

T = Thickness

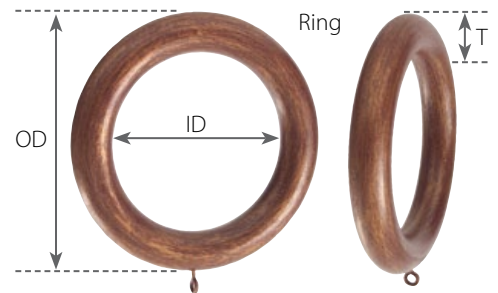
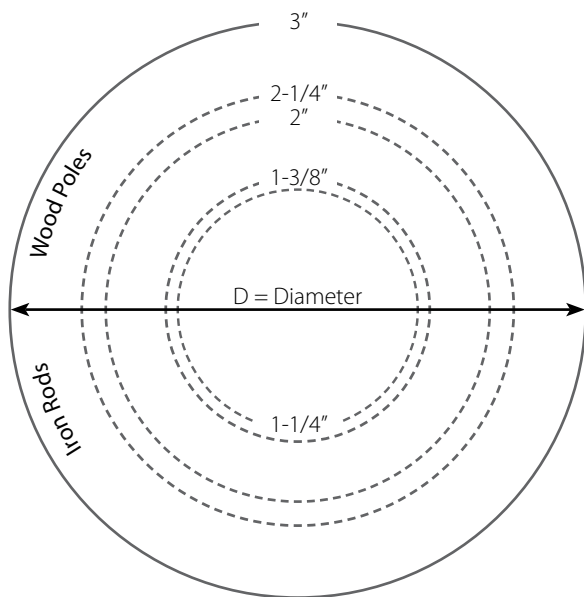

Celebrate Your Creativity...

# HAND-MADE IN USA

## Your order gets us started.

You choose the hardware, then select from any of our 58 hand-painted Décor Finishes, our Dual Finish System with 11 Accent Finishes , or choose a Custom Color from our limitless Custom Palette program.



From design concept, to finial and pole style (including traversing; manual or motorized), to the final hand-painting, Design Art by Orion is hand-made just for you at Orion here in the USA.



In September 2014, Orion was voted as a finalist in the Martha Stewart American Made Awards. Orion is delighted to have been a finalist in this amazing group of makers, small-business owners, and creative entrepreneurs who have turned their passion for quality craftsmanship and well-designed goods into a way of life.



Your complete delight in our products and service, from start to finish, is our single most important goal. We say, **“Our world revolves around you.”** – and we mean it. That’s why we always ask for your feedback. We know we are only practically perfect, but we keep trying.



And to complete the product cycle, we want you to know that **“Going Green”** is important at Orion. That’s why we offer you a chance to join us in support of conservation and preservation work.





6918 Tujunga Avenue  
North Hollywood, California 91605-6212

Toll Free: (877) 476-6278  
Tel: (818) 752-0688

Toll-Free Fax: (866) 296-7466  
Fax: (818) 752-5672  
sales@designartbyorion.com  
www.designartbyorion.com

