

# GRABER®



Graber Overture Sheer Shades  
English US Price Guide

# OVERTURE SHEER SHADES

## Product Information Guide

### Features

Overture Sheer Shades . . . . .	2
Fabric Styles and Information: Sheer Shades . . . . .	3 – 4
Light Control and Privacy, Fabric Recommendations, Light Gap, Fabric Disclaimers . . . . .	5
Cleaning and Care Information, Fabric Certifications . . . . .	6

### Size Considerations

Continuous-Loop Lift and Motorized Lift Mounting Depth Illustrations . . . . .	7
Maximum Shade Size . . . . .	8 - 12

### Options

Shade Options, Projection Brackets . . . . .	13
Continuous-Loop Lift Control, Motorized Lift . . . . .	14
Corner Windows, Adjacent Shadings . . . . .	15
Bay Windows . . . . .	16

### General Information

Continuous-Loop Lift . . . . .	17
Continuous-Loop Lift and Motorized Lift . . . . .	18
Continuous-Loop Lift Product Detail . . . . .	19
Color Coordination Charts . . . . .	20 – 21

## PLEASE NOTE:

Photos and illustrations are for inspiration only.  
Not all product configurations are available in all countries.

Window blind cords are a strangulation hazard for young children.  
Consult your dealer or store associate for cordless products, or products with inaccessible cords. Remove this product immediately if a cord longer than 22 cm, or a loop exceeding 44 cm, becomes accessible.

## VEUILLEZ NOTER :

Les photos et les illustrations ne sont offertes qu'à titre d'inspiration.  
Toutes les configurations de produits ne sont pas disponibles dans tous les pays.

Les cordons pour store de fenêtre représentent un risque d'étranglement pour les jeunes enfants. Consultez votre dépositaire ou un associé de magasin pour des produits sans cordon ou des produits dont les cordons ne sont pas accessibles. Retirez ce produit immédiatement si un cordon mesurant plus de 22 cm de longueur ou une boucle dépassant 44 cm deviennent accessibles.

# GRABER®

DECEMBER 2022

# Features

## Overture Sheer Shades

- Two layers of fabric encase lightweight fabric vanes for effortless light control
- The sheer softens incoming light and helps filter out harmful UV rays while providing an outside view
- The light filtering option allows soft light to flow through while providing privacy
- Smaller vanes are often better for smaller-sized windows while larger vanes work best for larger windows and have the added advantage of providing more view-through

Features	Benefits
Continuous-Loop Lift	<ul style="list-style-type: none"> <li>• Cord and clutch system makes raising and lowering shade easy</li> <li>• Cord remains at same length, regardless of shade position</li> <li>• Choose left or right cord location</li> <li>• Color coordinated cords</li> <li>• Choose from six colors of bottomrail                             <ul style="list-style-type: none"> <li>• Bottomrail color selected is also used for cassette end caps and cord guide</li> </ul> </li> <li>• For Canadian orders, cord color is Bamboo only, and shrouded continuous loop lift is opaque.</li> </ul>
Motorized Lift	<ul style="list-style-type: none"> <li>• Window treatments can be operated from virtually anywhere in the home</li> <li>• Easily operate hard-to-reach or large window coverings</li> <li>• Operate multiple window treatments simultaneously or individually</li> </ul>
Fabric-Wrapped Cassette	<ul style="list-style-type: none"> <li>• Fabric-wrapped cassette (standard) creates a cohesive appearance in the window</li> </ul>

# Features

## Fabric Styles and Information: Sheer Shades

Style Name	Color Name	Opacity/Privacy	Oeko-Tex® Certified	Fire Retardant Rated	Green Guard
Alpine 2"	Milky Way	Light Filtering	No	No	●
	Quartz		No	No	●
Coastal Waves 2"	Gentle Gray	Light Filtering	●	No	No
	Montauk Slate		●	●	No
	Sea Salt		●	●	No
Deco Diamond 2"	Champagne	Light Filtering	●	No	No
	Elegant Gray		●	No	No
	Frost		●	●	No
	Icelandic		●	●	No
	Mink		●	●	No
	Shale		●	●	No
	Sultry White		●	●	No
Deco Diamond 3"	Evening Lustre	Light Filtering	●	No	No
Evening Star 2"	Moonlight	Room Darkening	No	No	●
	Twilight		No	No	●
Glessner 2" Glessner 3"	Cavalry	Light Filtering	●	●	No
	Downtown		●	●	No
	Glacial		●	●	No
	Limestone		●	●	No
	Portico		●	●	No
	Rodeo Drive		●	●	No
	Sandstone		●	●	No
	Stationery		●	●	No
	Vellum		●	●	No
Glessner Sheen 2" Glessner Sheen 3"	Bubbly	Light Filtering	●	No	No
	Gala		●	No	No
	Limousine		●	No	No
	Soiree		●	No	No
Glessner Woven 2" Glessner Woven 3"	Bamboo	Light Filtering	●	●	No
	Champagne		●	●	No
	Everglades		●	●	No
Lustrous 1"	Candlelight	Light Filtering	●	No	No
	Mercury		●	No	No
Lustrous 2"	Silversmith	Light Filtering	●	●	No
Marisco 2" Marisco 2¾"	Bechamel	Light Filtering	●	●	No
	Stationery		●	●	No

**NOTE:** All fabric composition consists of 100% polyester.

\*Styles have a 2" vane size with a unique design, limiting the outside view to 1".

## Features

### Fabric Styles and Information: Sheer Shades

Style Name	Color Name	Opacity/Privacy	Oeko-Tex® Certified	Fire Retardant Rated	Green Guard
Modern Grid 1"	Chalk	Light Filtering	•	•	No
	Dapper Gray		•	•	No
	Executive Gray		•	No	No
	Lilac		•	•	No
	Ocean Breeze		•	•	No
Roslin 1"	Downtown	Light Filtering	•	•	No
	Stationery		•	•	No
San Simeon 3"	Adirondack	Room Darkening	•	•	No
	Everglades		•	•	No
	Sandstone		•	•	No
	Silver Mine		•	•	No
	Stationery		•	•	No
	Vellum		•	•	No
Starlight 2"	Lunar Light	Light Filtering	•	•	No
	Milky Way		•	•	No
	Moonlit		•	•	No
	Sable		•	•	No
	Stardust		•	•	No
Starlight 3"	Evening Light	Light Filtering	•	No	No
Sun Reflections 2"	Dawn	Light Filtering	•	•	No
	Glisten		•	•	No
	Utopia		•	•	No
Surfside 2"	Driftwood	Light Filtering	•	•	No
	Moonbeam		•	•	No
	Mussel		•	•	No
	Soft Seashell		•	•	No
	White Sand		•	•	No
Surfside 3"	Evening View	Light Filtering	•	No	No
Winchester 1" *	Bechamel	Light Filtering	•	•	No
	Stationery		•	•	No
Winchester Sheen 1" *	Limousine	Light Filtering	•	No	No
	Soiree		•	No	No
	Sunset Strip		•	No	No
Winchester Woven 1" *	Champagne	Light Filtering	•	•	No
	Silver Mine		•	•	No

**NOTE:** All fabric composition consists of 100% polyester.

\*Styles have a 2" vane size with a unique design, limiting the outside view to 1".

# Features

## Light Control and Privacy

**Light Filtering\*:** Allows light to gently filter through and provides privacy. Images and shapes may be seen through these shades, but details are not visible. Deep fabric colors provide moderate light control, while light colors provide lower light control. **Privacy Level:** Moderate.

**Room Darkening\*:** Allows some light to filter into the room and provides privacy. Objects in a lit room seen through these shades appear as vague shapes. Deep fabric colors darken a room; light colors filter and diffuse bright sunlight. **Privacy Level:** Maximum.

\*These fabrics are translucent and their colors may be influenced by changing light conditions. Colors may appear to vary depending upon the time of day and type of lighting, as well as whether the shade is partially or fully open.

## Fabric Recommendations

Order all shades for the same room at the same time to ensure color consistency and to minimize dye lot variation. For side-by-side sheer shades, request vane alignment. Vanes can be aligned to within ¼".

**NOTE:** Shades must be ordered at the same time with the same fabric color and height. To ensure best results, combined shade width should be 102" or less.

## Light Gap

The fabric width is narrower than the finished shade width of the tube and its components. For optimal light and glare control, outside mount is recommended, or you may add a secondary sot window treatment (drapery or curtain) to hide the light gap on all inside mount. See chart below for light gap.

Control Type	Control End		Idle End	
	Inside Mount (inches)	Outside Mount (inches)	Inside Mount (inches)	Outside Mount (inches)
Continuous-Loop Lift	15/16	7/8	11/16	5/8
Motorized Lift	1 1/16	1	3/4	1 1/16

## Fabric Disclaimers

Due to the nature of the weaving process, some imperfections in the weave are normal. Fabric appearance can vary based on changing light conditions in the room.

Due to the construction and functionality of sheer shades, the front and back sheer fabric will not form a perfect seal against light leakage.

As with all textiles, the fabric is subject to some variations. Slight wrinkling, puckering, or bowing is inherent to this textile product and should be considered normal, acceptable quality.

# Features

## Cleaning and Care Information

Regular light dusting with a feather duster, vacuum with low suction, or a hair dryer on a cool temperature.

Professional blind cleaners use a variety of methods to clean blinds and vary in their capabilities. While Springs Window Fashions, LLC knows that many of our window treatments can be safely cleaned using the appropriate ultrasonic or injection/extraction cleaning methods, we cannot guarantee the outcome of any cleaning services provided by an independent company.

For assistance in locating a certified blind cleaner that serves your area, visit [blindcleaners.net](http://blindcleaners.net) or contact customer service.

## Fabric Certifications

**Oeko-Tex® Standard 100** certifies that our fabrics are free of PVC, halogen, lead, formaldehyde, allergenic dyes, pesticides, phenols, heavy metals, and meet all VOC content limits.

Oeko-Tex is a registered trademark of the Oeko-Tex Association.



**GREENGUARD Indoor Air Quality Certified® Fabrics:**

Many Graber® fabrics have been certified by GREENGUARD Environmental Institute (GEI) to be low chemical- and particle-emitting fabrics, which provides a healthier indoor air quality. The process used for certification complies with established indoor air quality standards and is performed by a third party lab. Please see [baliblinds.com](http://baliblinds.com) for more information.



# Size Considerations

## Continuous-Loop Lift and Motorized Lift Mounting Depth Illustrations

The following diagram illustrates the mounting depth requirements for shades mounted inside window casements.

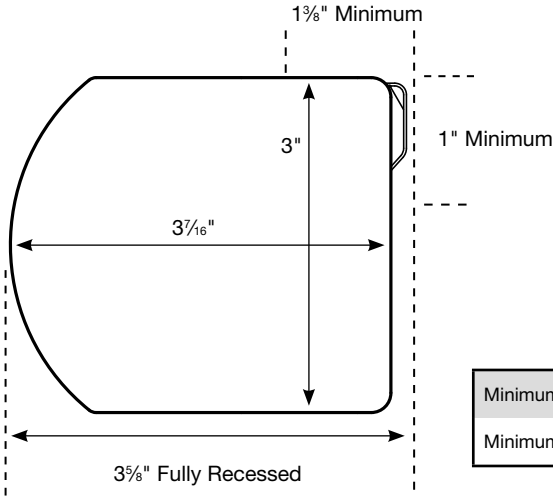
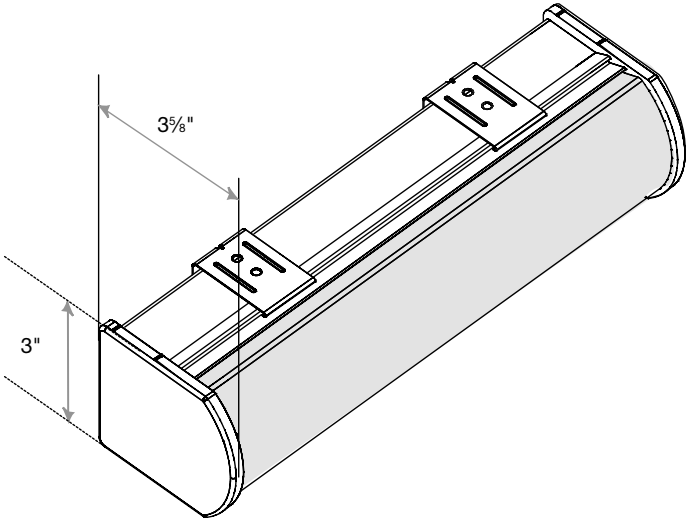

Fabric-Wrapped Cassette

Minimum Mounting Depth	1 3/8"
Minimum Mounting Depth, Flush Mount	3 5/8"



## Size Considerations

### Maximum Shade Size

Minimum width: Continuous-loop lift 12"

Minimum height: 12" all control types

	Continuous Cord Loop Control			
	Width		Height	
	Min (in.)	Max (in.)	Min (in.)	Max (in.)
Alpine 2"	12	79	12	110
Coastal Waves 2"	12	96	12	105
Deco Diamond 2"	12	96	12	105
Deco Diamond 3"	12	96	12	65
Evening Star 2"	12	71	12	85
Glessner 2"/Glessner 3"	12	96	12	105
Glessner Sheen 2"/ Glessner Sheen 3"	12	98	12	110
Glessner Woven 2"/ Glessner Woven 3"	12	96	12	110
Lustrous 1"	12	102	12	69
Lustrous 2"	12	96	12	105
Marisco 2"/ Marisco 2¾"	12	94	12	99
Modern Grid 1" 5301	12	102	12	69
Modern Grid 1" 5302, 5303, 5304	12	98	12	87
Modern Grid 1" 5300	12	94	12	75
Roslin 1"	12	94	12	75
San Simeon 3"	12	96	12	65
Starlight 2"	12	96	12	105
Starlight 3"	12	96	12	65
Sun Reflections 2"	12	96	12	105
Surfside 2"	12	96	12	105
Surfside 3"	12	96	12	65
Winchester 1"	12	97	12	87
Winchester Sheen 1"	12	102	12	69
Winchester Woven 1"	12	97	12	87

**NOTE:** Size availability is based on fabric. See size considerations grids for specific maximum shade sizes.

# Size Considerations

## Maximum Shade Size

**NOTE:** Shaded areas are available for order. Dark shading indicates availability in Canada. If only dark shading is present, shaded areas are available for order in both Canada and the United States.

Minimum width: Continuous-loop lift 12"  
 Minimum height: 12" all control types

For sizes within the next size break, please reach out to customer service or enter order into ordering system.

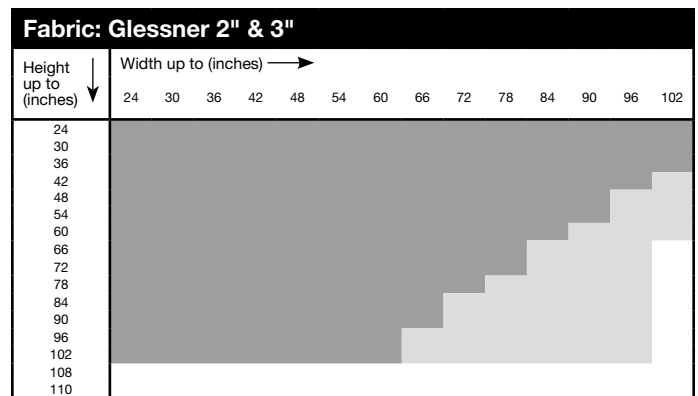
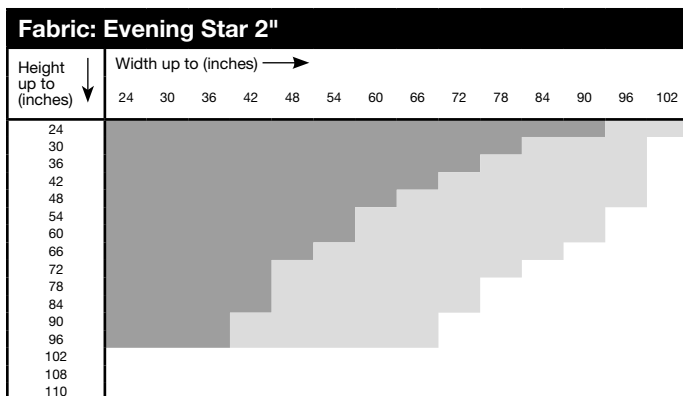
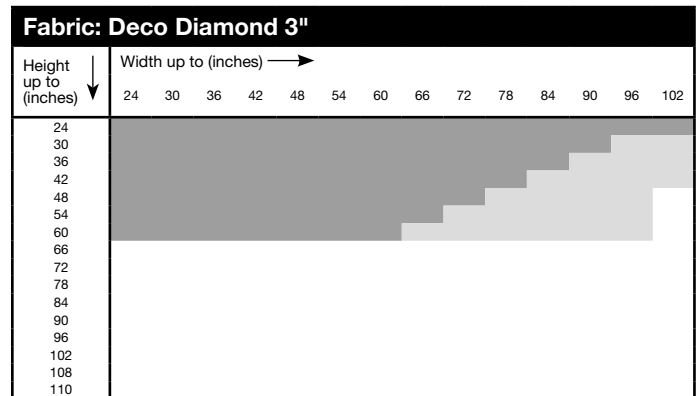
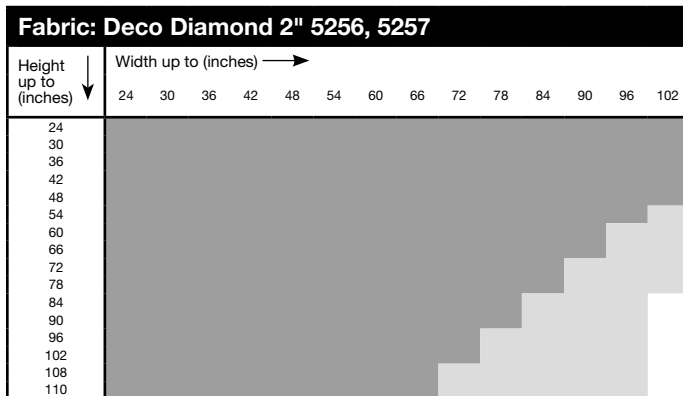
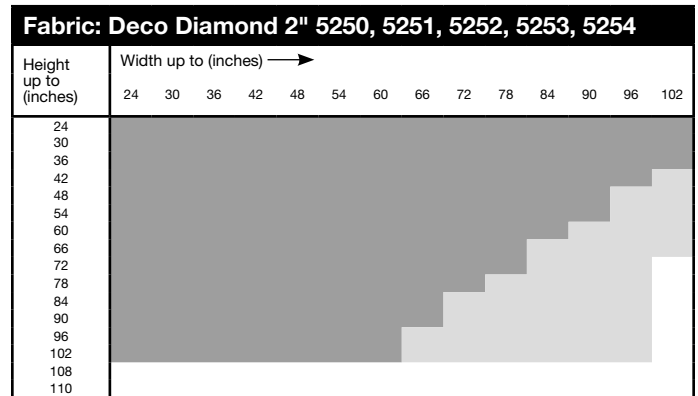
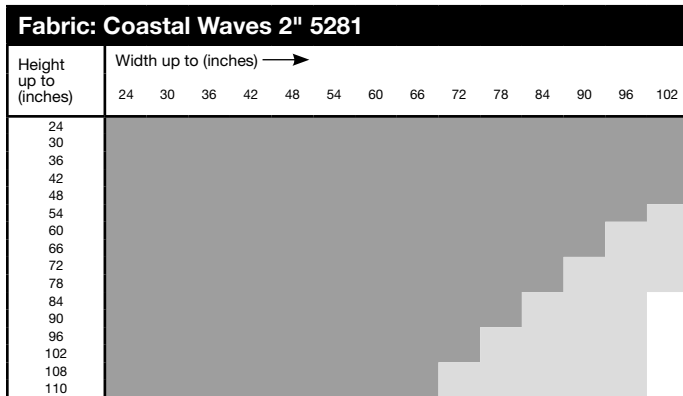
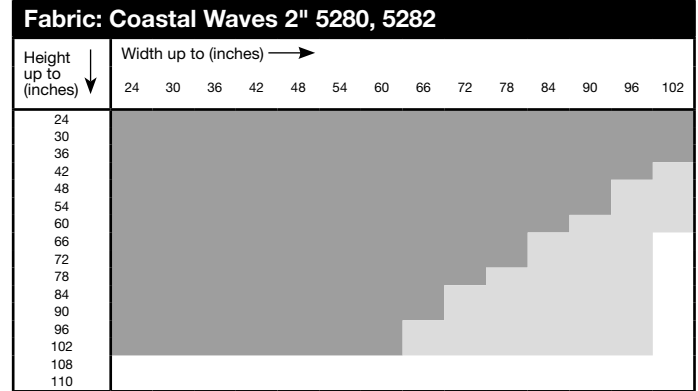
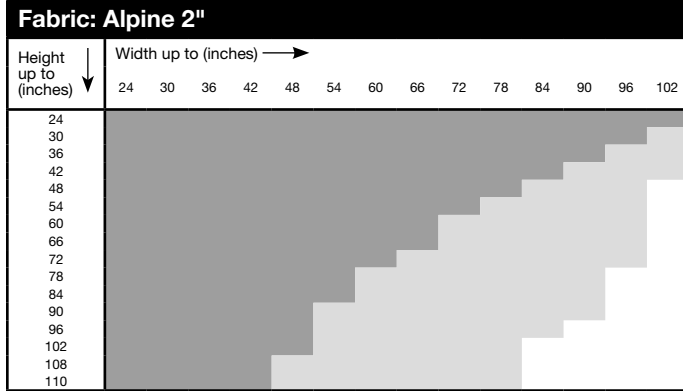

# Size Considerations

## Maximum Shade Size

**NOTE:** Shaded areas are available for order. Dark shading indicates availability in Canada.  
If only dark shading is present, shaded areas are available for order in both Canada and the United States.

Minimum width: Continuous-loop lift 12"  
Minimum height: 12" all control types

For sizes within the next size break, please reach out to customer service or enter order into ordering system.

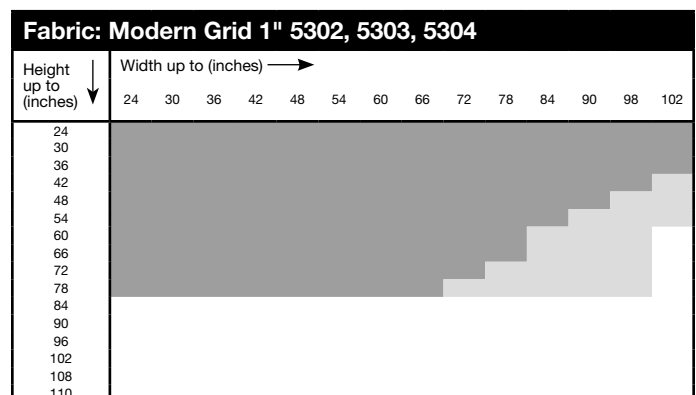
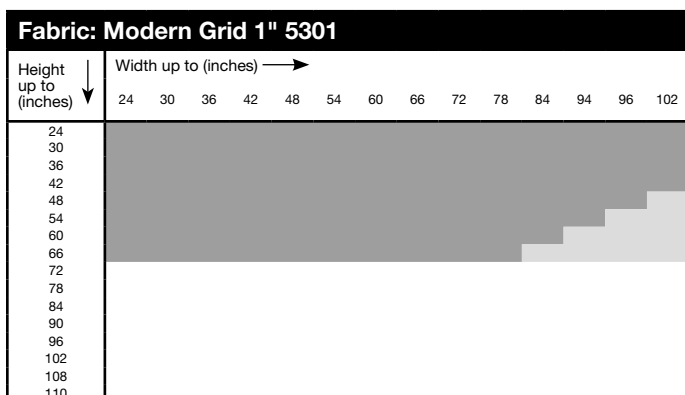
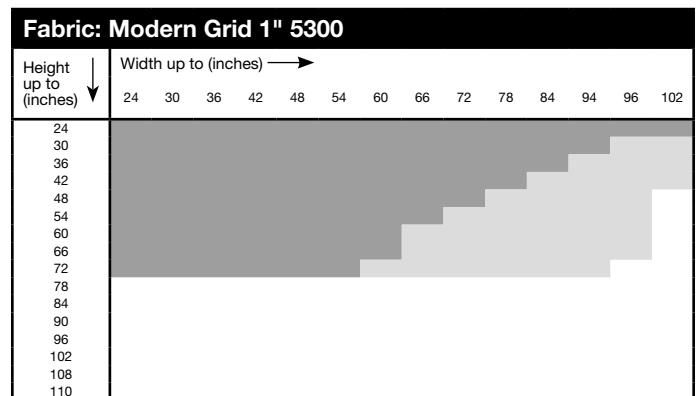
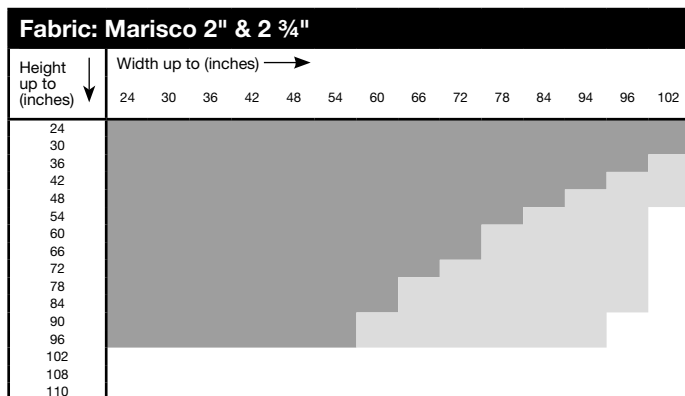
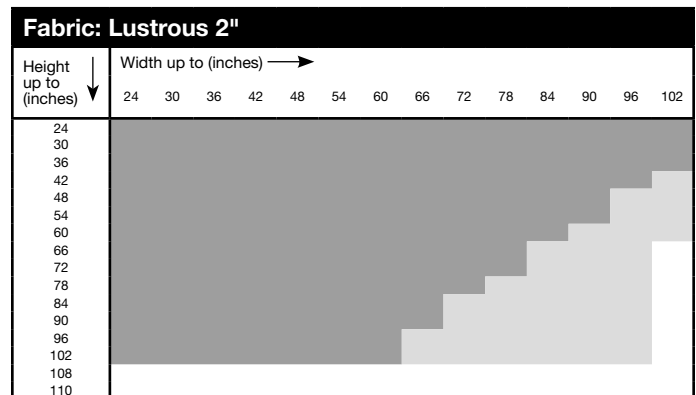
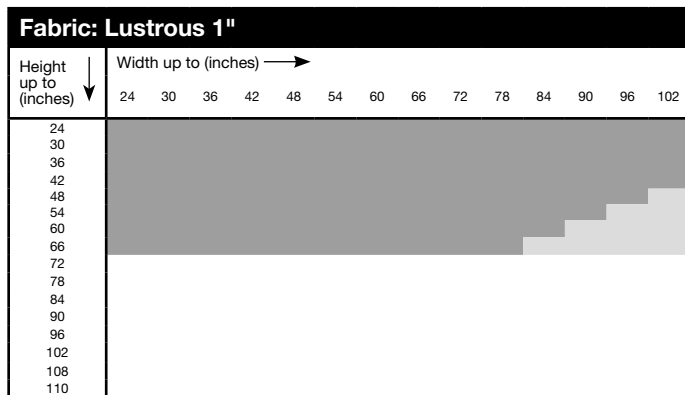
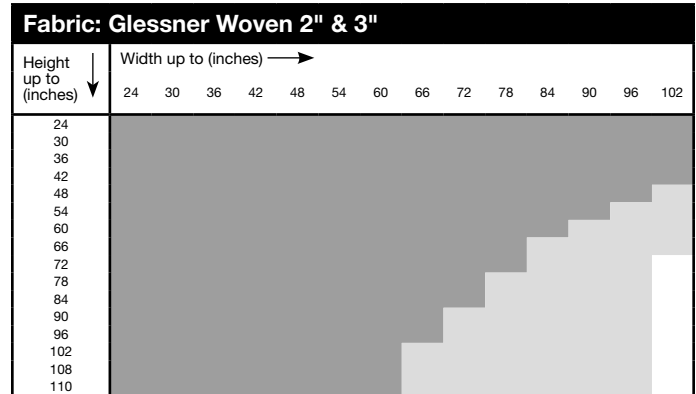
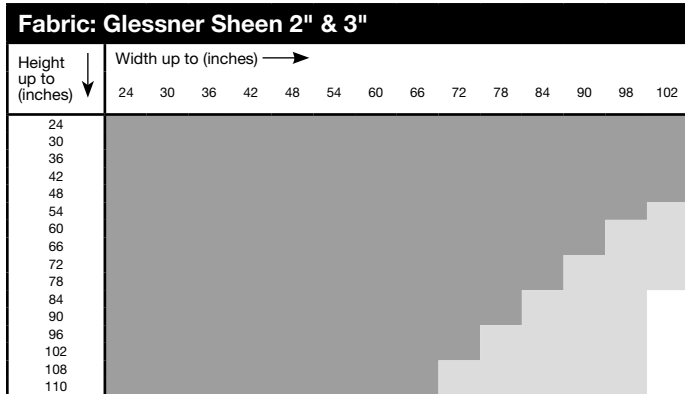

# Size Considerations

## Maximum Shade Size

**NOTE:** Shaded areas are available for order. Dark shading indicates availability in Canada. If only dark shading is present, shaded areas are available for order in both Canada and the United States.

Minimum width: Continuous-loop lift 12"  
 Minimum height: 12" all control types

For sizes within the next size break, please reach out to customer service or enter order into ordering system.

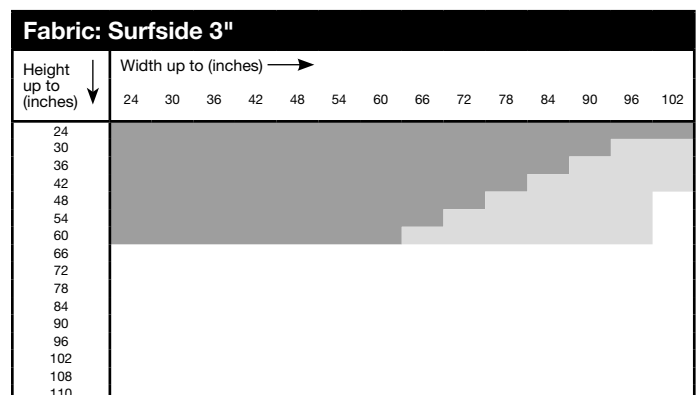
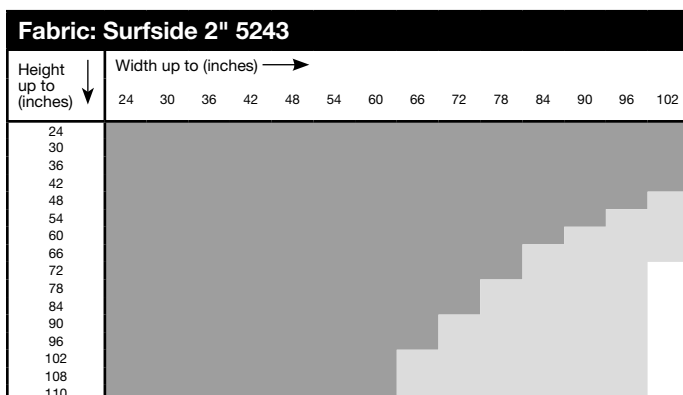
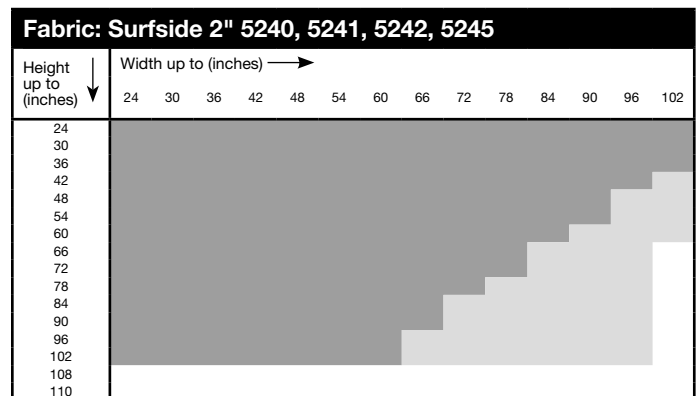
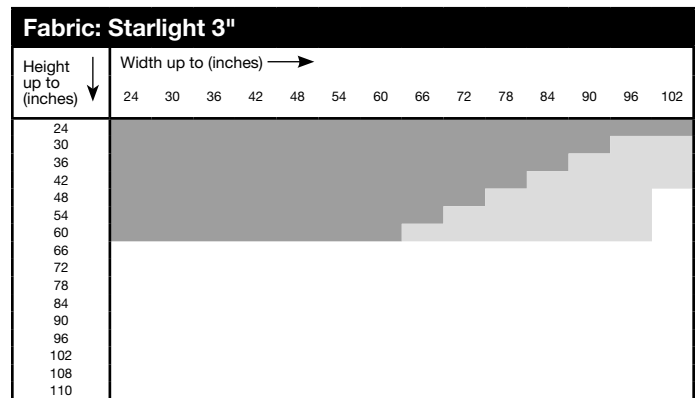
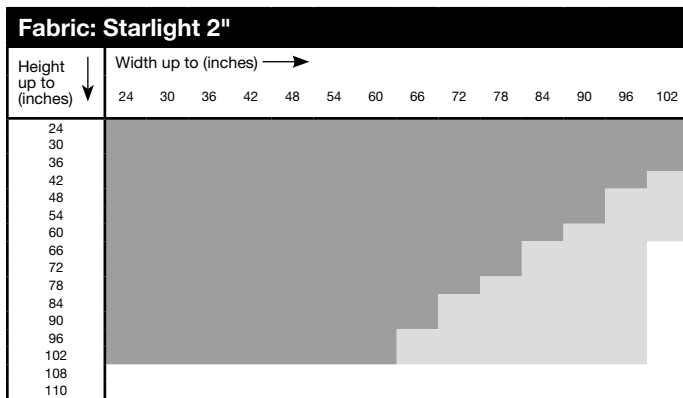
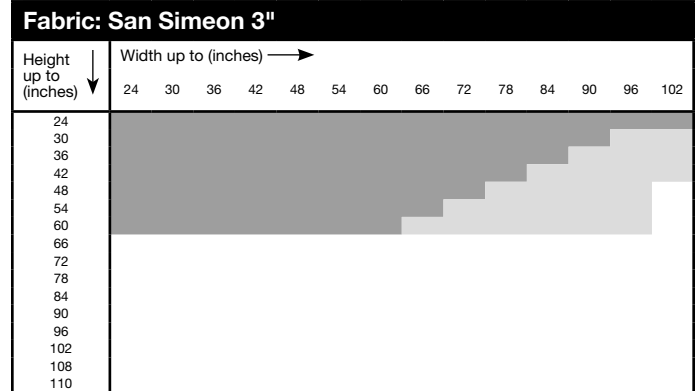
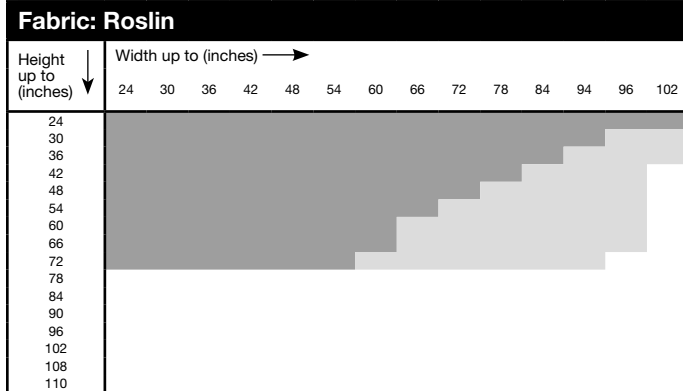

# Size Considerations

## Maximum Shade Size

**NOTE:** Shaded areas are available for order. Dark shading indicates availability in Canada.  
 If only dark shading is present, shaded areas are available for order in both Canada and the United States.

Minimum width: Continuous-loop lift 12"  
 Minimum height: 12" all control types

For sizes within the next size break, please reach out to customer service or enter order into ordering system.

### Fabric: Winchester 1"

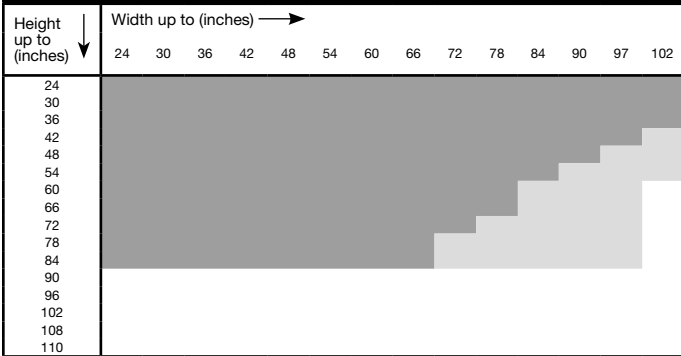

### Fabric: Winchester Sheen 1"

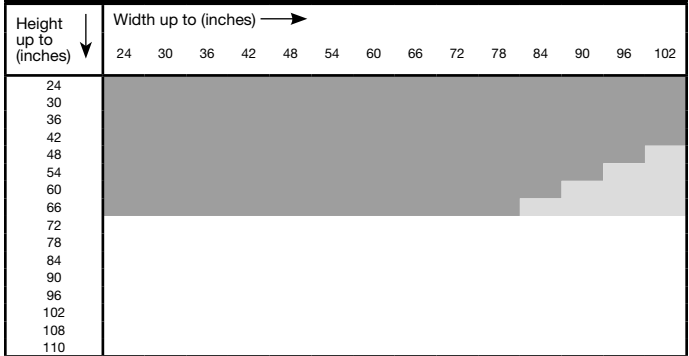

### Fabric: Winchester Woven 1"

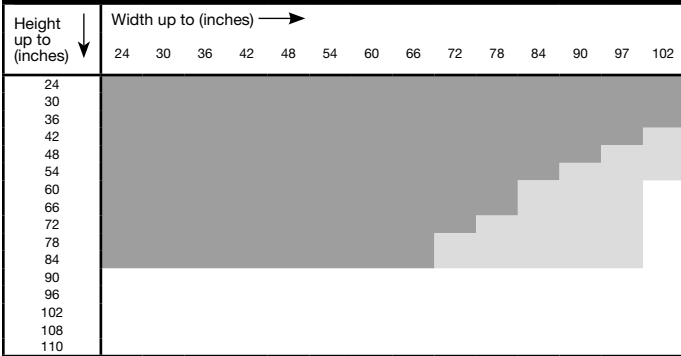

# Options

## Shade Options (for surcharges and pricing refer to price charts)

Below is a list of options for sheer shades. All options are available in all styles and colors. See detailed descriptions on the following pages.

### Control Type Options

- Continuous-loop lift
- Motorized lift (see motorization product information guide)

### Shade Options—No Charge

- Bottomrail and end cap colors
- Bay and corner windows
- Cord length (must specify different length)
- Cord location
- Projection brackets 3¼" and 4"
  - 3¼" projection brackets add up to 2⅛" extension from wall
  - 4" projection brackets add up to 2⅞" extension from wall

### Shade Options—Surcharge

- Motorization (see motorization product information guide)
- Palladian window shelf (see cornice, valance, and palladian window shelf product information guide)

## Projection Brackets

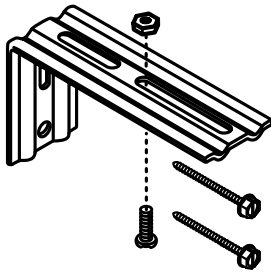

- **No charge**
- Available with continuous-loop lift and motorized lift
- Two sizes: 3¼" and 4"
- 3¼" projection brackets add up to 2⅛" extension from wall
- 4" projection brackets add up to 2⅞" extension from wall

# Options

## Continuous-Loop Lift Control

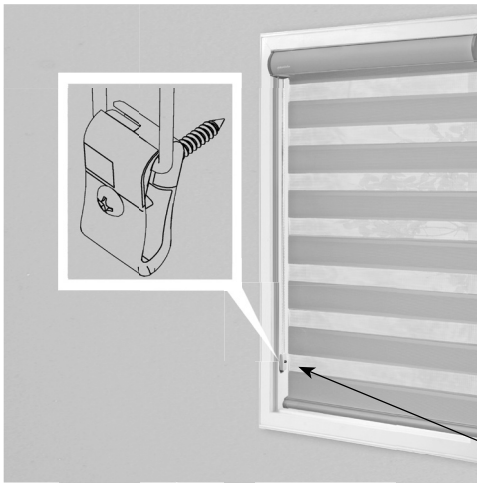

- **Standard**
- Cord loop and clutch system makes raising and lowering shade easy
- Special cord loop length must be requested at time of order
- Cord remains at same length regardless of shade position
- Color coordinated cord loop and cord guide
- Safety cord guide keeps the cord out of the reach of children and pets to enhance safety
- Choose left or right cord location
- Outside mount is recommended for maximum light control

**NOTE:** Cord guide must be installed to operate shade.



Inside Mount Light Gap  
Refer to Light Gap Chart

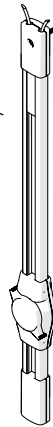

- For Canadian orders, cord color is Bamboo only, and shrouded continuous loop lift is opaque. See image pictured left.

## Motorized Lift



- **See motorization product information guide for accessories, additional options, sizing, and pricing**
- Down position will have vanes open
- Allows for easy operation of hard-to-reach or large window coverings
- Efficiently manages energy (heat gain and loss)
- Motorized lift shades are cordless and are a safer choice for homes with children or pets
- Low-voltage motorization requires no costly electrical hardwiring
- Available with multiple power and control options
- Motor located on the left or right side; standard on the right

**NOTE:** Motorization components and accessories have a five-year limited warranty, excluding batteries.



# Options

## Corner Windows



Shades on Corner Windows

- **No charge**
- Made as individual shades
- Each shade will have its own control; we recommend opposite corners
- Indicate for each shade whether butt or bypass
- Bypass shade is mounted into the corner; butt shade is butted to the other shade
- Manufacturer will take appropriate deductions for proper fit; DO NOT order as a corner shade if you do not want manufacturer to take deductions

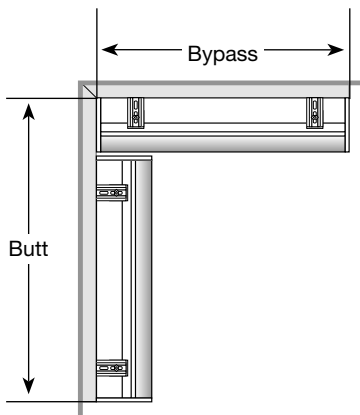

### Measuring Information

#### Mounting on a Wall or Molding:

Measure the width of each window from the corner on the mounting surface (molding or wall) to the point you would like to cover.

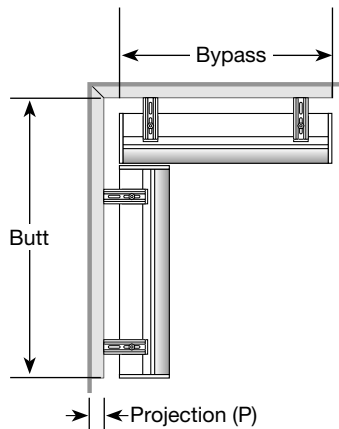

#### Mounting Above the Molding:

Measure the width of each window from the corner on the mounting surface to the point you would like to cover.

Projection measurement is the distance needed to clear any molding or obstructions that the shade will be mounted above.

**NOTE:** The projection (P) distance is needed to correctly calculate deductions for installations where the shades will use shims or projection brackets to clear molding. All projection distances must match for correct deductions to be calculated.

## Adjacent Shadings

To cover wide window openings, window shadings may be installed end to end so that the cassette headrails touch. The gap between the fabric panels of the adjacent shading varies by the control placement as shown in the chart.

Control Placement for Adjacent Shades			
Control Placement		Gap	
Left Shade Control	Right Shade Control	Continuous-Loop Lift (inches)	Motorized Lift (inches)
Right	Right	1 $\frac{5}{8}$	1 $\frac{1}{16}$
Left	Left	1 $\frac{5}{8}$	1 $\frac{1}{16}$
Right	Left	1 $\frac{5}{8}$	2
Left	Right	1 $\frac{5}{8}$	1 $\frac{3}{8}$

### Side-by-Side Alignment

Vane alignment to within  $\frac{1}{4}$ " is available upon request only for shades ordered at the same time with the same fabric color and height. Add note in special instructions. To ensure best results, combined shade width should be 102" or less.



# Options

## Bay Windows



Shades on Bay Windows

- **No charge**
- Made as individual shades
- Each section will have its own control
- Manufacturer will take appropriate deductions for proper fit; **DO NOT** order as a bay window shade if you do not want manufacturer to take deductions

### Measuring Information: Three-Sided Bay Window

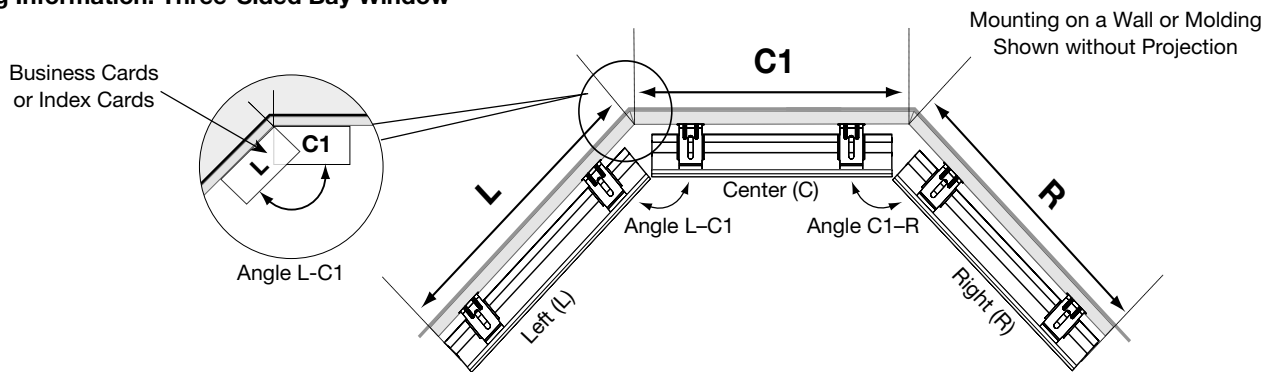

**Measure:**

- L and R:** Width of each side window from the corners on the mounting surface to the point you would like to cover.
- C1:** Width of the center window on the mounting surface from corner to corner.

- Angle L-C1:** Angle between the (L) and (C1) windows.
- Angle C1-R:** Angle between the (C1) and (R) windows.
- Projection:** If needed: the depth of the trim or molding the shade will be mounted above.

### Measuring Information: Four-Sided Bay Window

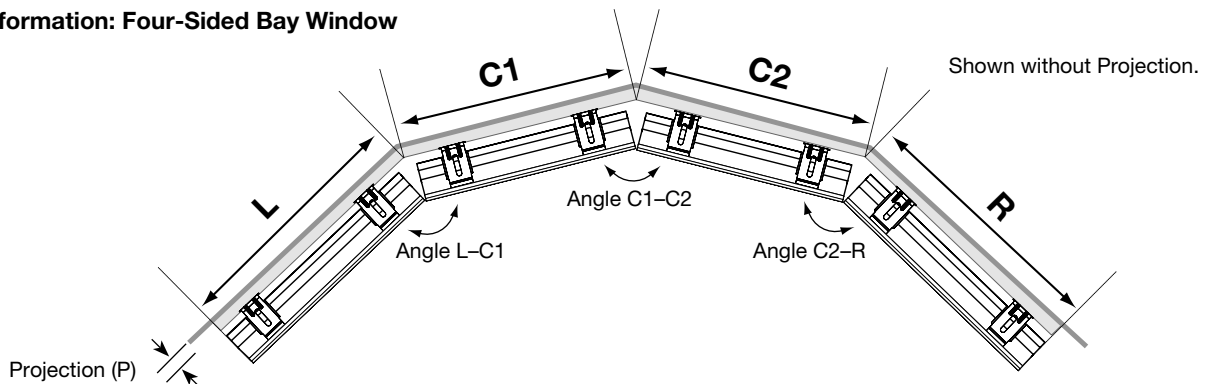

- L and R:** Width of each side window from the corners on the mounting surface to the point you would like to cover.
- C1, C2:** Width of each center window on the mounting surface from corner to corner.

- Angle L-C1:** Angle between the (L) and (C1) windows.
- Angle C1-C2:** Angle between the (C1) and (C2) windows.
- Angle C2-R:** Angle between the (C2) and (R) windows.
- Projection (P):** If needed: the depth of the trim or molding the shade will be mounted above.

**NOTE:** The projection (P) distance is needed to correctly calculate deductions for installations where the shades will use shims or projection brackets to clear trim or molding. All projection distances must match for correct deductions to be calculated. For additional windows on bays with up to five sides continue with number progression for center shade sizes (C1, C2, C3, ...) and angles (angle C1-C2, angle C2-C3, ...) as needed. Measure each bay angle using a protractor or angle finder or use two business cards in each bay corner as illustrated above, trace on paper, and fax to customer service.

**The angle to use between adjacent center bay windows along a straight section of wall is 180° (degrees).**

# General Information

## Continuous-Loop Lift

### Shade Operation

- A. To lower, pull down on the back cord.
- B. Continue to pull on the back cord when fully lowered to open the vanes. Over-rotation will occur if you continue to pull when the vanes are fully opened. The bottomrail will face into the room if over-rotated.
- C. To close, pull the front cord. Continue to pull on the front cord to raise the shade.

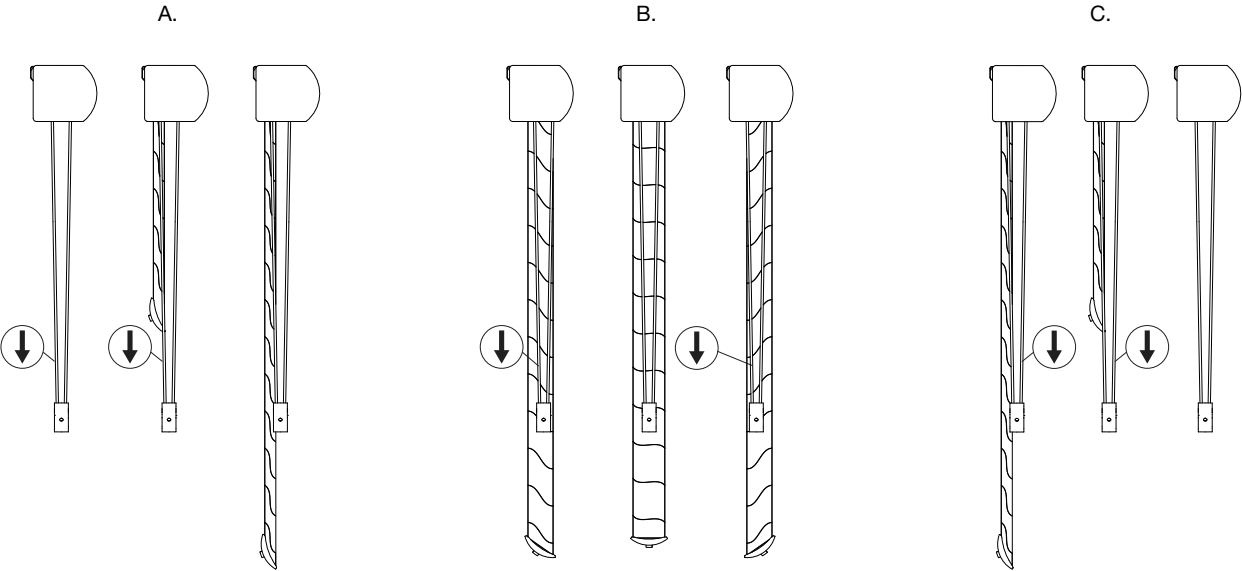

### Open Vanes

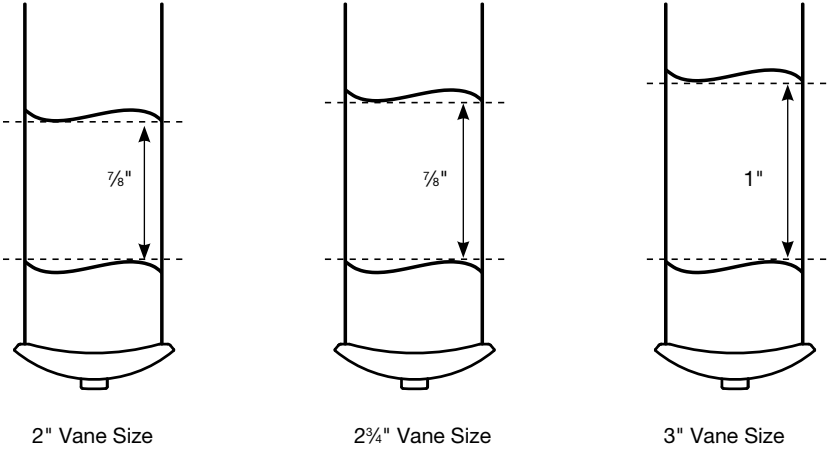

## General Information

### Continuous-Loop Lift and Motorized Lift

#### Closed Vanes

When closed, the vanes of sheer shades overlap providing privacy. Sheer shades may have light gaps towards the bottom of the shade.

#### Importance of Correct Shade Height

The bottomrail pivots when the vanes are opened and closed as shown below. The proper height measurement is critical in applications where the window shading closes just above a window sill or floor. If the window shading is too long and the bottomrail rests on the sill or floor when it is fully lowered, the rail cannot pivot freely and the vanes cannot be opened properly.

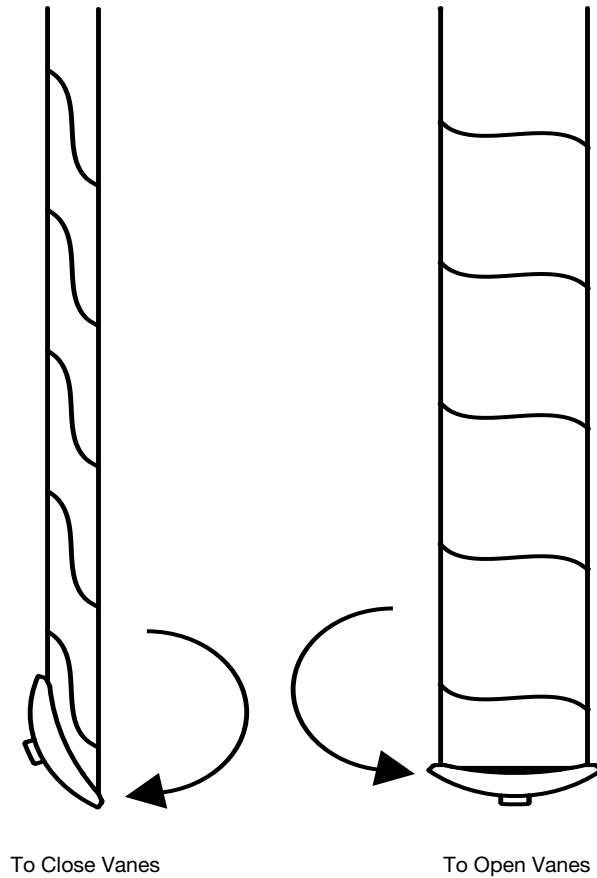

# General Information

## Continuous-Loop Lift Product Detail

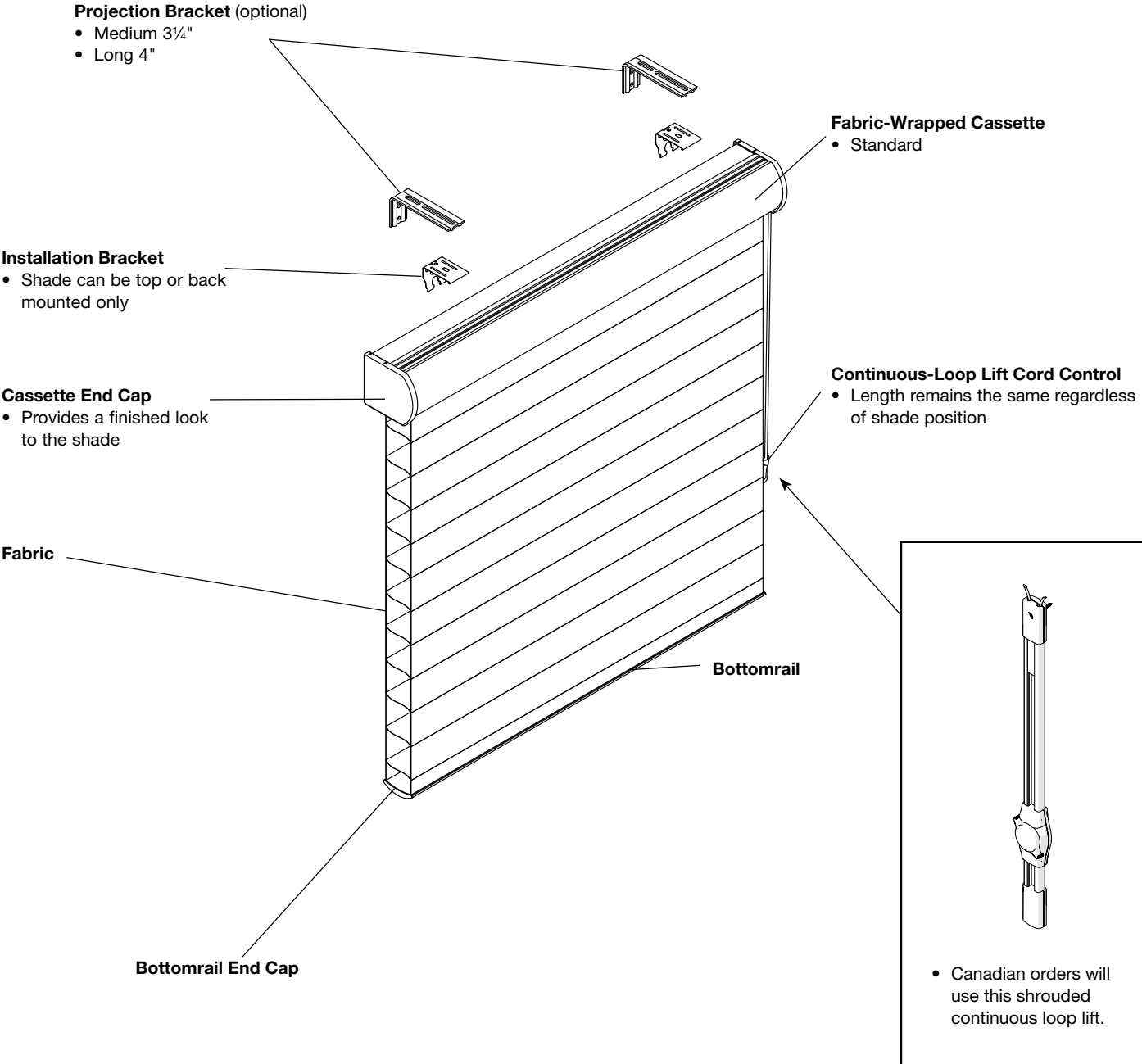

## General Information

### Color Coordination Charts

Color coordination is shown for informational purposes only.

Style	Color Name	Bottomrail Color	Continuous-Loop Lift
Alpine 2"	Milky Way	Cream	Bamboo
	Quartz	Classic Gray	Smokey Gray
Coastal Waves 2"	Gentle Gray	Classic Gray	Smokey Gray
	Montauk Slate	Classic Gray	Smokey Gray
	Sea Salt	White Satin	Bamboo
Deco Diamond 2"	Champagne	Cream	Bamboo
	Elegant Gray	White Satin	Bamboo
	Frost	White Satin	Bamboo
	Icelandic	White Satin	Bamboo
	Mink	Classic Gray	Smokey Gray
	Shale	Classic Gray	Smokey Gray
	Sultry White	White Satin	Bamboo
Deco Diamond 3"	Evening Lustre	White Satin	Bamboo
Evening Star 2"	Moonlight	Classic Gray	Smokey Gray
	Twilight	Classic Gray	Smokey Gray
Glessner 2"/ Glessner 3"	Cavalry	Classic Gray	Smokey Gray
	Downtown	Classic Gray	Smokey Gray
	Glacial	White Satin	Bamboo
	Limestone	Sand	Tuscany
	Portico	White Satin	Bamboo
	Rodeo Drive	White Satin	Bamboo
	Sandstone	Cream	Tuscany
	Stationery	White Satin	Bamboo
	Vellum	Cream	Bamboo
	Glessner Sheen 2"/ Glessner Sheen 3"	Bubbly	Cream
Gala		Cream	Bamboo
Limousine		Classic Gray	Smokey Gray
Soiree		White Satin	Bamboo
Glessner Woven 2"/ Glessner Woven 3"	Bamboo	Cream	Tuscany
	Champagne	Sand	Tuscany
	Everglades	Coffee	Cocoa
	Silver Mine	Classic Gray	Smokey Gray
Lustrous 1"	Candlelight	White Satin	Bamboo
	Mercury	Classic Gray	Smokey Gray
Lustrous 2"	Silversmith	Classic Gray	Smokey Gray
Marisco 2"/ Marisco 2¾"	Bechamel	Cream	Bamboo
	Stationery	White Satin	Bamboo
Modern Grid 1"	Chalk	White Satin	Bamboo
	Dapper Gray	Classic Gray	Smokey Gray
	Executive Gray	Classic Gray	Smokey Gray
	Lilac	White Satin	Bamboo
	Ocean Breeze	White Satin	Bamboo
Roslin 1"	Downtown	Classic Gray	Smokey Gray
	Stationery	White Satin	Bamboo
San Simeon 3"	Adirondack	Coffee	Cocoa
	Everglades	Coffee	Cocoa
	Sandstone	Sand	Tuscany
	Silver Mine	Classic Gray	Smokey Gray
	Stationery	White Satin	Bamboo
	Vellum	Cream	Bamboo

**NOTE:** Certain components are only available in limited colors. For Canadian orders, cord color is Bamboo only and shrouded continuous loop lift is opaque.

## General Information

### Color Coordination Charts (continued)

Color coordination is shown for informational purposes only.

Style	Color Name	Bottomrail Color	Continuous-Loop Lift
Starlight 2"	Lunar Light	Cream	Bamboo
	Milky Way	White Satin	Bamboo
	Moonlit	White Satin	Bamboo
	Sable	Classic Gray	Smokey Gray
	Stardust	White Satin	Bamboo
Starlight 3"	Evening Light	Classic Gray	Smokey Gray
Sun Reflections 2"	Dawn	Classic Gray	Smokey Gray
	Glisten	Classic Gray	Smokey Gray
	Utopia	White Satin	Bamboo
Surfside 2"	Driftwood	Cream	Tuscany
	Moonbeam	White Satin	Bamboo
	Mussel	Classic Gray	Smokey Gray
	Soft Seashell	Cream	Bamboo
	White Sand	White Satin	Bamboo
Surfside 3"	Evening View	Classic Gray	Smokey Gray
Winchester 1"	Bechamel	Cream	Bamboo
	Stationery	White Satin	Bamboo
	Limousine	Classic Gray	Smokey Gray
Winchester Sheen 1"	Soiree	White Satin	Bamboo
	Sunset Strip	Classic Gray	Smokey Gray
	Champagne	Sand	Tuscany
Winchester Woven 1"	Silver Mine	Classic Gray	Smokey Gray

Bottomrail Colors
Classic Gray
Coffee
Cream
Sand
White Satin

Continuous-Loop Lift Cord Colors
Bamboo
Cocoa
Smokey Gray
Tuscany

Continuous-Loop Lift Lengths (inches)
18
24
36
48
60
72
84

**NOTE:** Certain components are only available in limited colors. For Canadian orders, cord color is Bamboo only and shrouded continuous loop lift is opaque.

# GRABER®

Grabber is a brand of Springs Window Fashions, the Best Experience Company

Grabber and the Grabber logo are registered trademarks of Springs Window Fashions, LLC.

(12/22) 22-393904

# GRABER.

## Graber Overture Sheer Shades Designer US Price List — Effective June 2022

### Price Group A: Marisco 2", Marisco 2 3/4", Evening Star, Alpine

Height up to inches (cm) ↓	Width up to inches (cm) →												
	24 (61)	32 (81.3)	36 (91.5)	42 (106.7)	48 (122)	54 (137.2)	60 (152.4)	66 (167.7)	72 (182.9)	78 (198.2)	84 (213.4)	96 (243.9)	102 (259.1)
36 (96)	629	697	781	853	928	1003	1075	1153	1307	1415	1457	1603	1700
42 (106.7)	656	747	822	905	985	1070	1153	1232	1391	1505	1551	1713	1816
48 (122)	695	783	871	955	1045	1135	1230	1318	1482	1607	1650	1825	1956
54 (137.2)	719	821	914	1016	1109	1205	1305	1409	1568	1698	1749	1949	2091
60 (152.4)	750	862	962	1065	1163	1271	1381	1489	1641	1779	1858	2072	2239
66 (167.7)	765	899	1015	1118	1232	1346	1470	1582	1733	1879	1972	2203	2356
72 (182.9)	822	940	1055	1170	1295	1422	1551	1672	1851	2005	2074	2327	2448
78 (198.2)	839	971	1096	1218	1347	1482	1615	1753	1935	2097	2207	2470	2650
84 (213.4)	880	1015	1136	1278	1416	1557	1707	1847	2032	2203	2326	2603	2787
96 (243.9)	942	1090	1235	1387	1551	1708	1867	2024	2227	2414	2512	2860	3065
110 (279.4)	1032	1248	1395	1547	1710	1866	2027	2183	2388	2585	2671	3020	3226

NOTE: Size availability is based on fabric. See minimum and maximum charts for specific sizes.

#### Marisco 2"

Bechamel	6200	Stationery	6201
----------	------	------------	------

#### Marisco 2 3/4"

Bechamel	7200	Stationery	7201
----------	------	------------	------

#### Evening Star

Moonlight	5221	Twilight	5220
-----------	------	----------	------

#### Alpine

Milky Way	5200	Quartz	5201
-----------	------	--------	------

**Price Group B: Glessner 2", Glessner 3", Roslin, Winchester, Lustrous, Surfside,**

**Modern Grid**

Height up to inches (cm) ↓	Width up to inches (cm) →												
	24 (61)	32 (81.3)	36 (91.5)	42 (106.7)	48 (122)	54 (137.2)	60 (152.4)	66 (167.7)	72 (182.9)	78 (198.2)	84 (213.4)	96 (243.9)	102 (259.1)
36 (96)	702	783	874	957	1040	1124	1202	1293	1467	1588	1634	1797	1906
42 (106.7)	737	836	921	1016	1101	1199	1293	1380	1558	1688	1741	1920	2033
48 (122)	778	878	976	1071	1172	1271	1379	1480	1660	1799	1847	2046	2194
54 (137.2)	803	916	1025	1135	1243	1349	1462	1580	1758	1904	1959	2184	2346
60 (152.4)	838	968	1078	1193	1302	1424	1549	1671	1841	1996	2083	2323	2510
66 (167.7)	858	1006	1134	1252	1380	1510	1647	1773	1944	2104	2209	2470	2643
72 (182.9)	921	1051	1183	1310	1450	1594	1739	1875	2074	2247	2325	2609	2745
78 (198.2)	940	1089	1228	1365	1511	1661	1810	1965	2168	2349	2473	2770	2971
84 (213.4)	984	1134	1274	1434	1587	1744	1913	2068	2278	2469	2607	2920	3126
96 (243.9)	1056	1224	1384	1557	1739	1914	2094	2269	2497	2705	2817	3208	3438
110 (279.4)	1215	1399	1583	1784	1960	2141	2381	2611	2787	3019	3161	3527	3746

NOTE: Size availability is based on fabric. See minimum and maximum charts for specific sizes.

<b>Glessner 2"</b>					
Cavalry	5117	Limestone	5111	Sandstone	5121
Downtown	5124	Portico	5101	Stationery	5125
Glacial	5100	Rodeo Drive	5118	Vellum	5122

<b>Glessner 3"</b>					
Cavalry	6117	Limestone	6111	Sandstone	6121
Downtown	6124	Portico	6101	Stationery	6125
Glacial	6100	Rodeo Drive	6118	Vellum	6122

<b>Roslin</b>					
Downtown	7243	Stationery	7247		

<b>Winchester</b>					
Bechamel	7261	Stationery	7260		

<b>Lustrous</b>					
Candlelight	5226	Mercury	5227	Silversmith	5225

<b>Surfside</b>					
Driftwood	5243	Moonbeam	5241	Soft Seashell	5245
Evening View	5244	Mussel	5242	White Sand	5240

<b>Modern Grid</b>					
Chalk	5300	Executive Gray	5301	Ocean Breeze	5303
Dapper Gray	5304	Lilac	5302		



**Price Group C: Glessner Woven 2", Glessner Woven 3",  
San Simeon 3", Winchester Woven, Coastal Waves**

Height up to inches (cm) ↓	Width up to inches (cm) →												
	24 (61)	32 (81.3)	36 (91.5)	42 (106.7)	48 (122)	54 (137.2)	60 (152.4)	66 (167.7)	72 (182.9)	78 (198.2)	84 (213.4)	96 (243.9)	102 (259.1)
36 (96)	777	865	966	1056	1146	1244	1330	1427	1620	1756	1812	1991	2107
42 (106.7)	812	922	1016	1117	1220	1323	1427	1524	1733	1880	1928	2129	2252
48 (122)	852	966	1075	1182	1298	1406	1520	1633	1833	1986	2048	2261	2432
54 (137.2)	887	1012	1134	1257	1366	1494	1610	1742	1938	2099	2172	2421	2597
60 (152.4)	930	1061	1193	1318	1438	1577	1718	1855	2042	2212	2301	2579	2780
66 (167.7)	950	1107	1255	1392	1524	1670	1823	1971	2149	2326	2444	2740	2923
72 (182.9)	1016	1163	1312	1449	1604	1774	1925	2081	2293	2483	2583	2886	3043
78 (198.2)	1051	1199	1358	1510	1670	1848	2014	2178	2404	2605	2750	3074	3292
84 (213.4)	1089	1255	1407	1581	1757	1934	2118	2290	2527	2739	2885	3237	3468
96 (243.9)	1171	1346	1525	1720	1925	2120	2312	2513	2760	2989	3127	3558	3808
110 (279.4)	1345	1544	1755	1973	2177	2377	2636	2895	3094	3353	3505	3911	4151

<b>Glessner Woven 2"</b>						
Bamboo		5181	Champagne	5183	Silver Mine	5182

<b>Glessner Woven 3"</b>						
Bamboo		6181	Champagne	6183	Silver Mine	6182

<b>San Simeon 3"</b>						
Adirondack		7224	Sandstone	7221	Stationery	7225
Everglades		7220	Silver Mine	7223	Vellum	7222

<b>Winchester Woven</b>						
Champagne		7264	Silver Mine	7265		

<b>Coastal Waves</b>						
Gentle Gray		5281	Montauk Slate	5282	Sea Salt	5280

**Price Group D: Glessner Sheen 2", Glessner Sheen 3", Winchester Sheen**

Height up to inches (cm) ↓	Width up to inches (cm) →												
	24 (61)	32 (81.3)	36 (91.5)	42 (106.7)	48 (122)	54 (137.2)	60 (152.4)	66 (167.7)	72 (182.9)	78 (198.2)	84 (213.4)	96 (243.9)	102 (259.1)
36 (96)	862	960	1075	1178	1279	1386	1481	1592	1810	1961	2025	2222	2351
42 (106.7)	905	1027	1132	1251	1362	1475	1592	1700	1932	2093	2156	2374	2518
48 (122)	949	1076	1201	1320	1448	1567	1695	1819	2049	2218	2289	2532	2719
54 (137.2)	987	1128	1267	1401	1525	1662	1804	1943	2169	2349	2429	2708	2903
60 (152.4)	1034	1186	1329	1471	1606	1760	1919	2074	2279	2471	2568	2881	3105
66 (167.7)	1055	1239	1396	1548	1700	1865	2036	2199	2404	2604	2732	3058	3271
72 (182.9)	1132	1294	1462	1622	1790	1975	2152	2323	2566	2779	2886	3226	3397
78 (198.2)	1170	1336	1513	1686	1866	2061	2240	2431	2684	2910	3072	3438	3681
84 (213.4)	1337	1525	1711	1916	2102	2280	2499	2719	3034	3288	3407	3769	4028
96 (243.9)	1432	1633	1845	2063	2269	2471	2707	2945	3275	3549	3633	4086	4385
110 (279.4)	1641	1875	2131	2374	2578	2786	3090	3362	3670	3973	4079	4500	4781

NOTE: Size availability is based on fabric. See minimum and maximum charts for specific sizes.

<b>Glessner Sheen 2"</b>					
Bubbly	5161	Limousine	5162	Soiree	5163

<b>Glessner Sheen 3"</b>					
Bubbly	6161	Limousine	6162	Soiree	6163

<b>Winchester Sheen</b>					
Limousine	7301	Soiree	7302	Sunset Strip	7300

## Price Group E: Sun Reflections, Deco Diamond, Starlight

Height up to inches (cm) ↓	Width up to inches (cm) →												
	24 (61)	32 (81.3)	36 (91.5)	42 (106.7)	48 (122)	54 (137.2)	60 (152.4)	66 (167.7)	72 (182.9)	78 (198.2)	84 (213.4)	96 (243.9)	102 (259.1)
36 (96)	931	1037	1162	1273	1381	1498	1600	1720	1955	2118	2187	2400	2540
42 (106.7)	977	1109	1223	1351	1471	1593	1720	1835	2087	2261	2328	2564	2720
48 (122)	1025	1163	1297	1427	1564	1692	1831	1964	2212	2395	2472	2735	2937
54 (137.2)	1066	1218	1368	1513	1647	1795	1948	2098	2342	2537	2623	2924	3134
60 (152.4)	1117	1280	1435	1588	1735	1901	2072	2240	2462	2669	2773	3112	3354
66 (167.7)	1139	1338	1507	1672	1835	2015	2199	2375	2597	2812	2950	3303	3533
72 (182.9)	1223	1397	1579	1752	1933	2132	2324	2508	2771	3001	3117	3484	3669
78 (198.2)	1264	1443	1635	1821	2016	2226	2419	2625	2898	3143	3319	3713	3976
84 (213.4)	1444	1647	1848	2069	2270	2463	2699	2937	3277	3550	3680	4071	4351
96 (243.9)	1546	1763	1992	2228	2450	2669	2923	3181	3537	3834	3923	4413	4736
110 (279.4)	1772	2025	2302	2564	2784	3009	3337	3631	3963	4291	4405	4861	5163

NOTE: Size availability is based on fabric. See minimum and maximum charts for specific sizes.

Sun Reflections					
Dawn	5230	Glisten	5231	Utopia	5232

Deco Diamond					
Champagne	5256	Frost	5252	Shale	5253
Elegant Gray	5257	Icelandic	5250	Sultry White	5251
Evening Lustre	5255	Mink	5254		

Starlight					
Evening Light	5310	Milky Way	5313	Sable	5312
Lunar Light	5311	Moonlit	5314	Stardust	5316

## Options Pricing

Bay and Corner Window Shades	No charge
Bottomrail Color	No charge
Continuous-Loop Lift	No charge
Fabric-Wrapped Cassette	Standard—No charge
Motorized Lift	See motorization product information guide
Projection Brackets	No charge
Wood Cornice and Valance	See cornices and valances product information guide