

GRABER | DELIGHT IN
EVERY DETAIL



Graber Wood Shutters English/US Price Guide

TRADITIONS™ WOOD SHUTTERS

Product Information Guide

Features

The Springs Window Fashions (SWF) Wood Story	3
Wood Characteristics	4
Shutter Styles	5-6
Product Illustration: Wood Shutters	7
Product Illustration: Panel Detail	7

Options

Frame Type Decision Tree	8
Measuring Standard Wood Shutters	9
Color Options	10
Additional Color Information	10
Graber® Custom Color	10
Custom Color Match Process	10
Louver Options	11
Hardware Options	12
Panel Overlap Options	12
Tilt Type Options: Overview	12
Tilt Type Options: Front Tilt	13
Tilt Type Options: Hide-A-Tilt™	13-14
Tilt Options: Split Tilt	14
Divider Rail Requirements	15
Measuring Divider Rail or Split Tilt Location	15
Measuring T-Post Locations	15
Standard Shutters Wood Panel Configurations	16
Wood Frame Configurations	17
Frame Product Detail	18-21

Specifications

Proper Application of the Tilt-Out Z-Frame	22
Sill Cap Application	22
Deductions for Frame Allowances	23
Installation Hardware	23

Size Considerations

All Louver Sizes: Minimum and Maximum	24
Standard Shutters: Minimum and Maximum	25

GRABER®

JULY 2022

(7/22) 22-346650

Specialty Styles

Café Shutters	26
Double Hung Shutters	27
Double Hung Shutters: Minimum and Maximum Order Width	28
Measuring Double Hung Split Location	28
Double Hung Shutters: Minimum and Maximum Order Height	29
Sunburst Arch without Frame	30
Sunburst Arch with Frame	31
Framed Arch Installation Option	32
Frameless Arch Installation Options	32
Arch and Angle Top Panel Shutters	33
Arch and Angle Top Panel Shutters Height Limitations	34
Measuring Leg Height and Divider Rail Height for Window Opening	34
Measuring Leg Height and Divider Rail Height for Frame-to-Frame Measurement	34
How to Make a Template	35
French Door Options	36
French Door Sizes: Minimum and Maximum	36
French Door Shutters: Placement of L-Frame	36
French Door Shutters: Recessed Back Plate	36
French Door Options: Cut-Out	37
Bypass Shutters	38
Bypass Valance Options	38
Valance Keystones	38
Bypass Shutters: Mounting Options	39
Bypass Track System Configuration Options	40
Bypass Shutters: Minimum and Maximum Width	40
Bypass Track System Stack Back Option	41
Custom Header	41
Bifold Track System Stack Back Option	41
Bifold Track System	42
Bifold Track System: Mounting Options	42
Bifold Shutters Minimum and Maximum Width	43
Bifold Valance Options	43
Sidelight	44
Bay Windows	45-46
Corner Windows	47-48

General Information

Definitions	49
Care Instructions	49

Features

The Springs Window Fashions (SWF) Wood Story

Quality of Wood Defines a Shutter's Quality

We use only 100% North American hardwood in the construction of our wood shutters because of its light weight, consistent color, hardness, structural stability, and attractive grain.

Sound Forestry Techniques

We work only with foresters who practice "sustained yield forest management"—nearly twice as much hardwood grows as is harvested in the U.S. each year. The volume of hardwoods in American forests today is 90% larger than it was 50 years ago.

Preserving Our Natural Resources

Our SWF wood facility in Grayling, Michigan, consumes recycled sawdust and wood shavings, generating the heat required to dry lumber, for a completely self-sufficient manufacturing process. Our Reynosa, Mexico, fabrication and finishing facility is 99.7% pollution-free, above any U.S. standard.

SWF Wood Facility in Grayling, Michigan

We have control over the quality of wood used—we control the process from green lumber to finished shutters. Hardwoods used in crafting Graber® Wood Shutters are kiln-dried and molded at our SWF wood facility. The wood is dried slowly to strict wood shutter specifications because structural change can occur when moisture is removed. Molding and sanding operations provide the highest quality surface, free of defects.

SWF Wood Fabrication and Finishing in Reynosa, Mexico

At our state-of-the-art finishing plant in Reynosa, Mexico, components are carefully sorted prior to fabrication for color uniformity and wood characteristics. We sort wood as an end user, rather than as a finishing vendor, taking out defects in a climate-controlled building. Each shutter is handmade by craftsmen to your client's custom needs. To finish the shutter, we use only high quality paints and stains; on-site certified color technicians provide both application and quality control.

What Makes SWF Shutters Different from the Rest?

- Wood shutters are made from 100% North American hardwoods—the premier wood used in the construction of shutters
- SWF wood facilities provide state-of-the-art technologies and processes
- Expanded finish choices with unique staining process that showcases the natural grain of the wood
- An outstanding selection of styles, louvers (including 4½" size), frames, and arches
- The best customer service team in the industry—trained to answer any questions about Graber Wood Shutters
- Limited lifetime warranty

Features

Wood Characteristics

Wood used to manufacture Graber® Wood Shutters has many natural characteristics that make it truly unique. No two pieces of hardwood are alike. The following are all natural characteristics of wood, and we do not consider them to be defects:

- Grain—the direction, size, and appearance of wood fibers vary greatly depending on where the wood is cut within the tree
- Mineral Marks—dark or discolored areas caused by minerals that the tree extracts from the soil; they can be either streaks or stains, usually blackish blue
- Tiger Striping—directional change in grain pattern
- Burl—formed from an irregular growth on the outer edge of the tree
- Bird's Eye—small area on the surface of the board where fibers are contorted to form circular figures that resemble birds' eyes
- Knots—vary in size, shape, structure, and color (only solid knots less than 3/8" diameter are allowed)

Natural variations in color and grain effect are inherent in the beauty of wood. These variations are within established industry guidelines and should be expected. In addition, shutters may stain slightly darker or lighter than the samples shown.

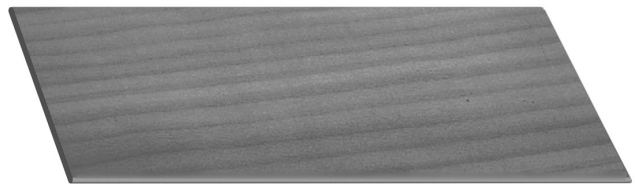

Flat Grain

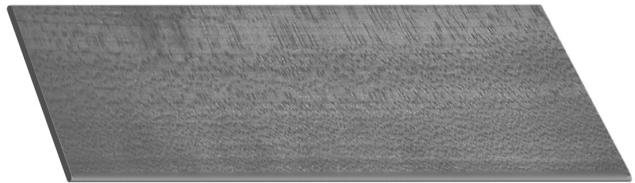

Grain Change



Mineral Marks

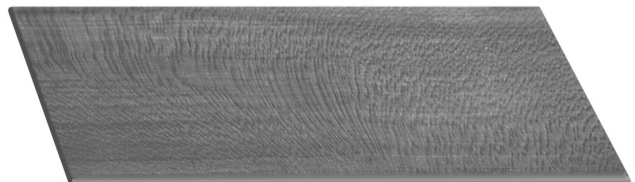

Tiger Striping

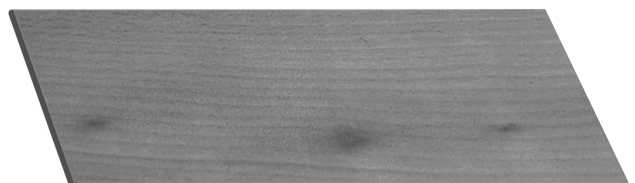

Burl/Bird's Eye

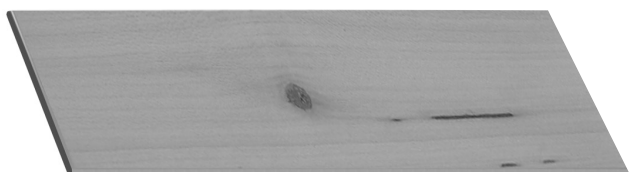

Knots

Features

Shutter Styles

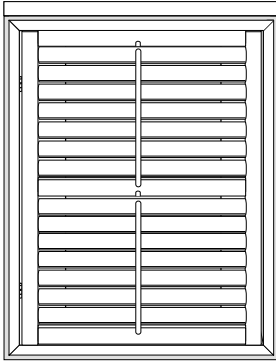

Standard Panel: A rectangular-shaped panel that can be installed using any frame style. Panel covers the entire window opening.

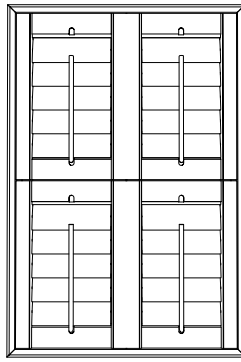

Double Hung: Versatile style in which panels are mounted separately on top of each other, allowing the top and bottom to be opened independently.

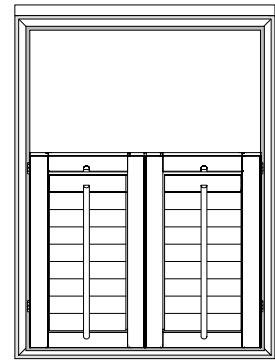

Café: Classic style covers the bottom part of the window, allowing light to enter while protecting your privacy. A good choice for bedrooms or kitchens.

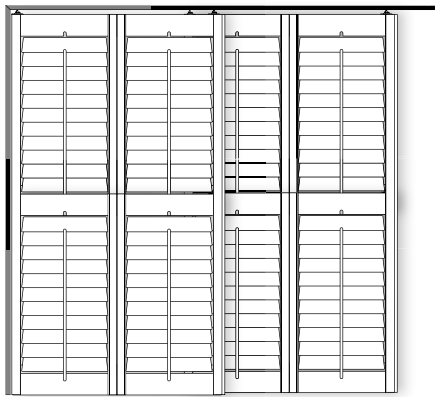

Bypass Track System: Shutter panels slide on double top tracks to open and close. The track system can be ordered with a box-out (side frame) or with the header mounted directly to a window casing or the ceiling. Ideal for patios or closet doors. Louvers must be closed to pass.

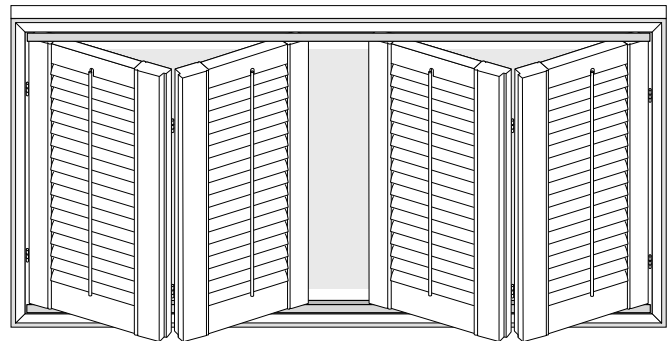

Bifold Track System: Two, four, or eight panels are hinged together with a top and bottom track. Popular for large windows, patio doors, or sliding glass doors.

NOTE: Remember that shutters do not block all light from entering the room. All shutters have moving parts. These parts have tolerance gaps that will allow some light to filter through the shutter.

Features

Shutter Styles

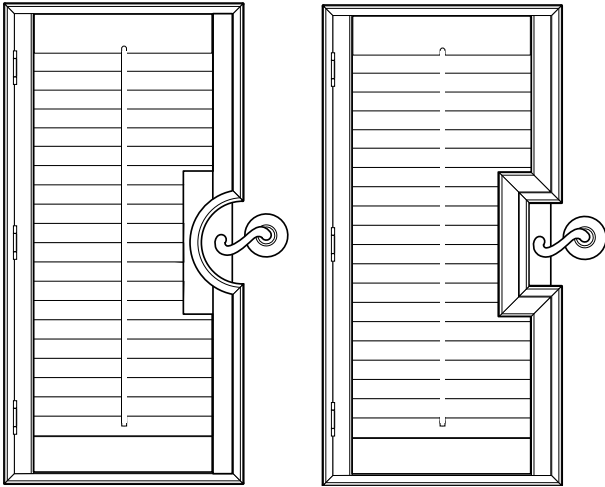

French Doors: Add the beauty of shutters to French doors. Curved or rectangular cut-out options complement contemporary door handles or traditional door knobs.

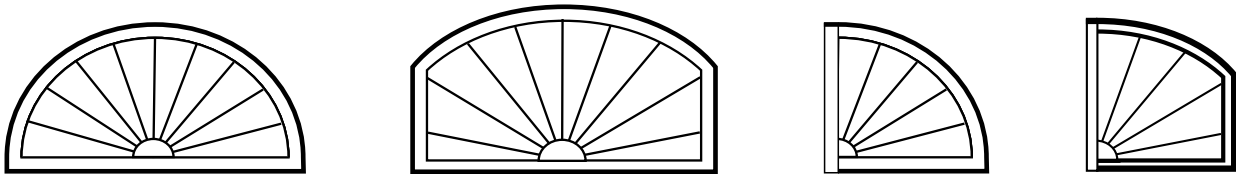

Sunburst Arches: Sunburst patterned louvers cover unique window silhouettes such as eyebrow, elongated, and elliptical arches. Also available as $\frac{1}{4}$ arches.

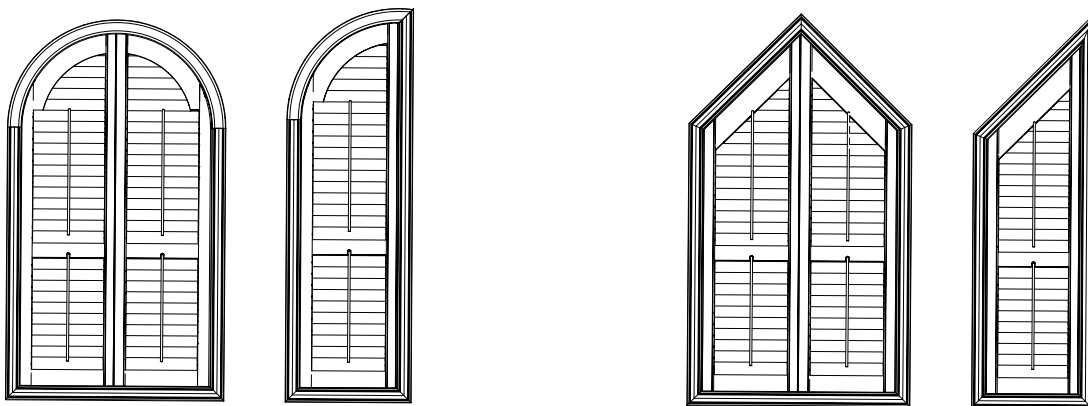

Arched Panels: Provide whole window solutions that fit the rounded shape of full arch windows perfectly. Available in full arch panel or $\frac{1}{2}$ arch panel.

Angled Top Panels: Provide whole window solutions that accommodate slanted windows. Available in full angle panel or $\frac{1}{2}$ angle panel.

Features

Product Illustration: Wood Shutters

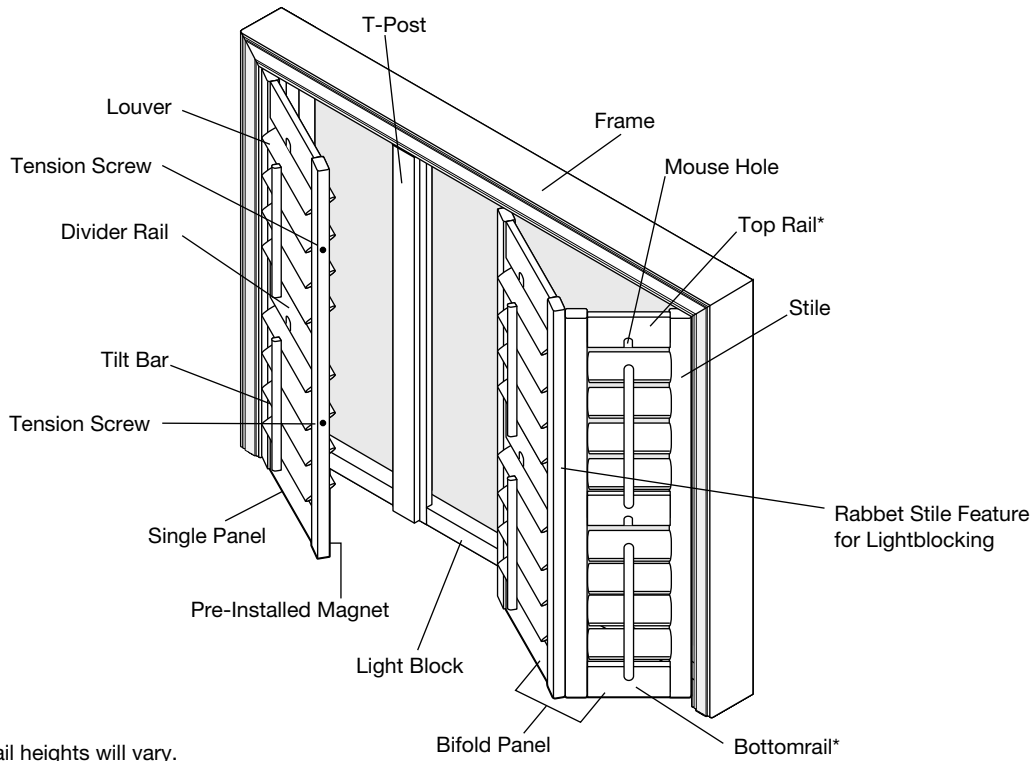

*Top and bottomrail heights will vary.

Product Illustration: Panel Detail

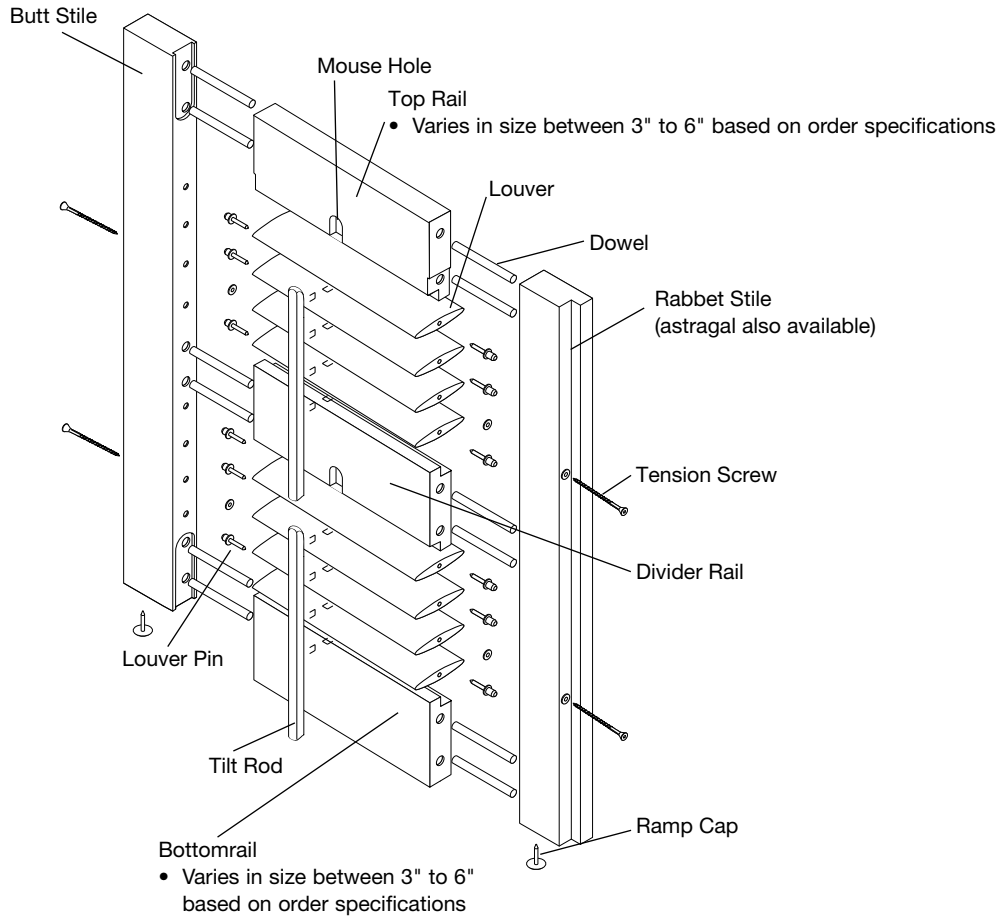

Options

Frame Type Decision Tree

Review window and the area around the window. Choose from the options below.

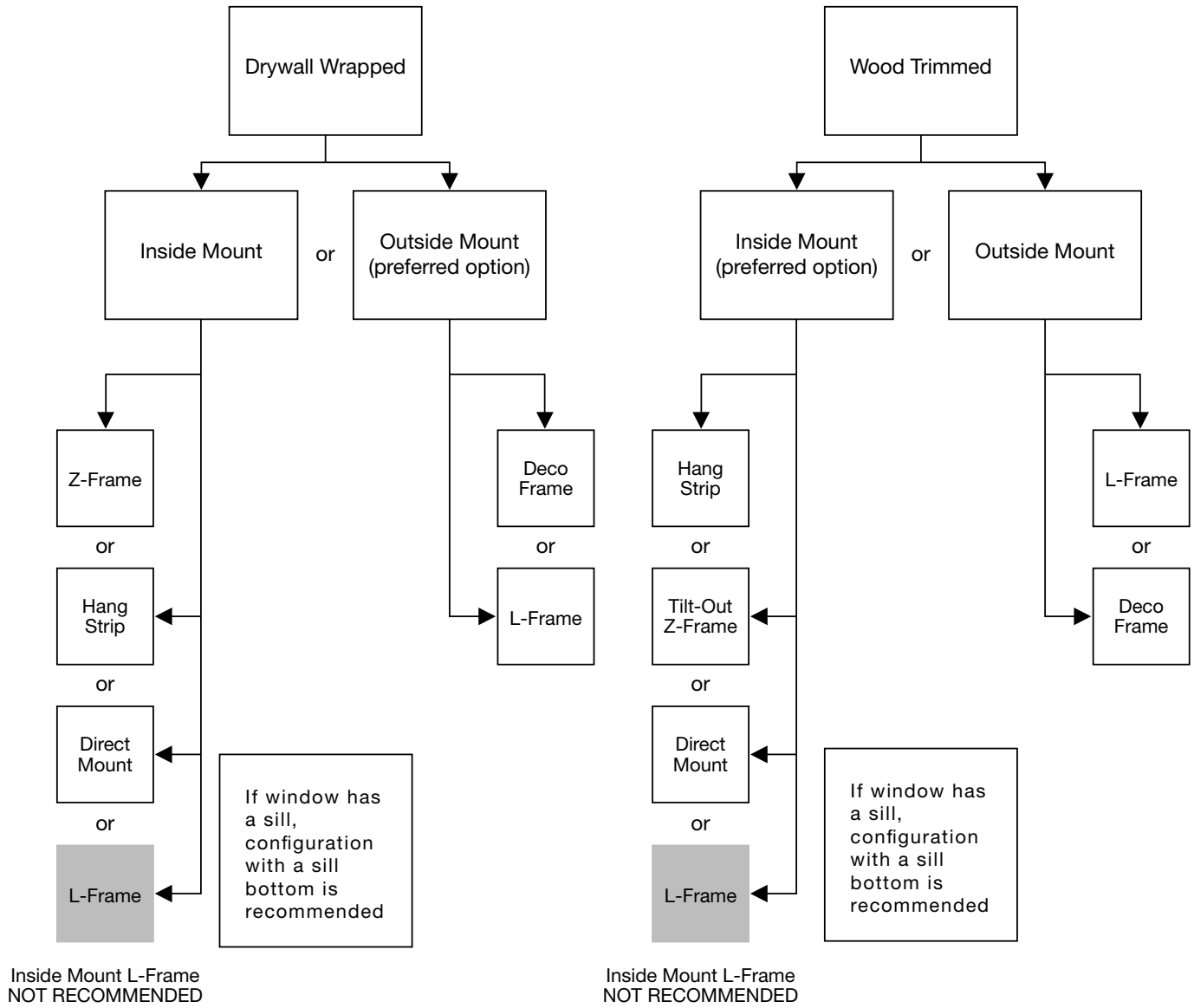

Options

Measuring Standard Wood Shutters

Confirm That The Window Is Square.

Measure the diagonals. If the difference between the two diagonal measurements in the same window is greater than $\frac{1}{4}$ ", an outside mount shutter is required.

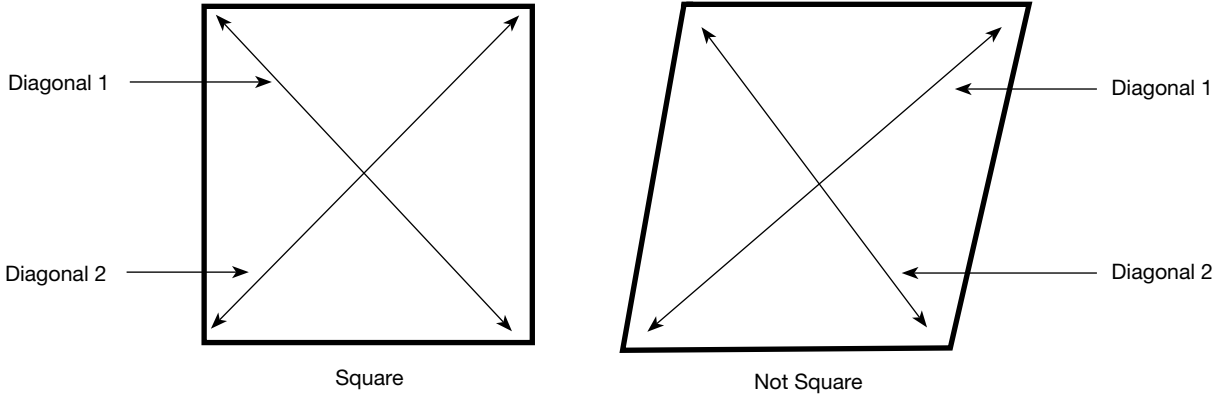

Window Opening Measurement

Inside Mount with Hang Strips, Direct Mount, Z-Frame, Tilt-Out Z-Frame

- Measure the width at three points and the height at three points
- Use the **SMALLEST** width and height measurements

NOTE: Factory makes no allowances/deductions for tilt-out Z-frame.

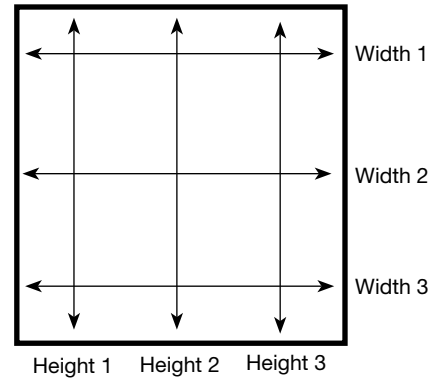

Frame-to-Frame Measurement

Required for L-Frame and Deco Frame

- Place a sample of the L-frame or deco frame on the window frame or wall to determine frame-to-frame placement
- Measure frame-to-frame width at three points and frame-to-frame height at three points
- Use the **LARGEST** width and height measurements

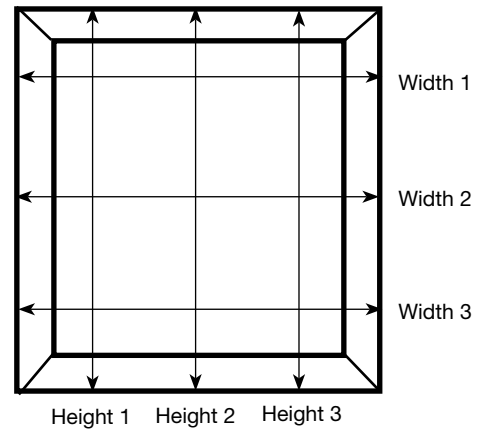

HELPFUL HINT: If shutters are in the same room and/or side by side, shutters must be ordered at the same height to ensure that rail height, divider rail location, louver count, and hinge quantity will match.

NOTE: See "Corner Windows" and "Bay Windows" sections for measuring instructions.

Options

Color Options: Refer to Price List

Additional Color Information

Due to the nature of manufacturing, colors may vary slightly between dye lots. Please order all shutters for the same room at the same time. Slight variations may also occur between the finished products and the color samples (see “Wood Characteristics” section).

Graber® Custom Color

Choosing an appropriate color for Graber Wood Shutters is critical to pulling a room’s style together. With our unique custom color matching, your clients will never have to compromise on color again! We will even color match a competitor’s color at no extra charge.

Just provide a color swatch or sample of the color you want to match—woodwork, wall coverings, paint, fabric—and our expert color technicians will provide an exact color match.

NOTE: See custom color form for colors that do not require a sample to be submitted. A strike-off approval will still be required prior to production.

Custom Color Match Process

1. Complete the custom color match request form.
2. Supply Springs Window Fashions with a color sample.
For best results, submit a 3" x 3" color sample.
3. Send the form and the sample to:
Springs Window Fashions
1500 Sycamore Road G5
Montoursville, PA 17754
Attn: Custom Color Department
4. Strike-off approval is required for all shutter orders.
5. Strike-offs will be sent for approval within 10 to 14 days of receiving the color sample.
6. Once color approval is received, fabrication of the custom shutters will begin. Lead time begins once color is approved.

NOTE: A color chip must be sent or color on file must be chosen. We cannot accept paint formulas from vendors.

Options

Louver Options

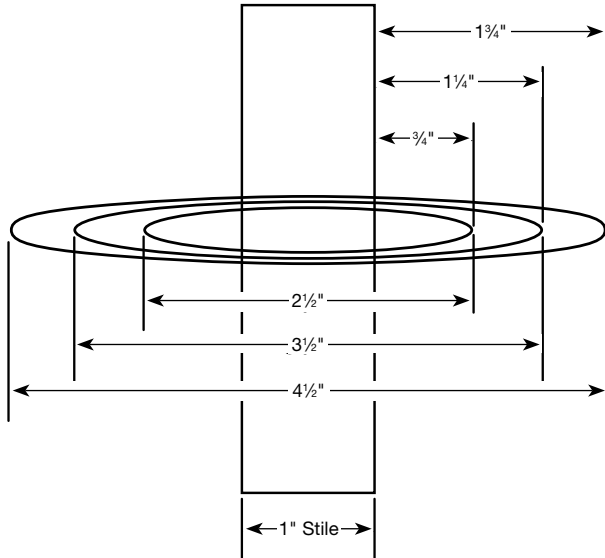

Minimum Clearance Needed from Back Panel Surface		
Louver Size (inches)	Standard Tilt (inches)	Hide-A-Tilt™ (inches)
2½	¾	1½
3½	1¼	1½
4½	1¾	2½

NOTE: Hide-A-Tilt requires an additional ¾" window clearance.

Minimum Clearance Needed by Louver Size and Frame Type Standard Tilt (Hide-A-Tilt)							
Louver Size (inches)	Direct Mount (inches)	Hang Strip (inches)	Standard Z-Frame (inches)	Legacy Z-Frame (inches)	Signature, Bullnose, and Craftsman Z-Frames (inches)	2" L-Frame (inches)	Traditional Deco and Tilt-Out Z-Frames (inches)
2½	1¼ (2⅝)	2⅝ (2⅞)	1⅝ (1¾)	1⅝ (1⅞)	1⅝ (1⅞)	0 (0)	¼ (⅝)
3½	2¼ (2⅝)	2⅝ (2⅞)	1⅞ (2¼)	1⅞ (2⅝)	1⅞ (2⅞)	½ (⅞)	¾ (1⅞)
4½	2¾ (3⅞)	2¾ (3⅞)	2⅞ (2¾)	2⅞ (2⅞)	2⅞ (2⅞)	1 (1¾)	1¼ (1⅞)

2½" Louver

- Traditional in style
- Minimal window depth needed
- Shutters are focal point of the room

3½" Louver

- Most popular louver size
- Offers more visibility and light control than 2½" louver

4½" Louver

- Provides the greatest visibility through the open louvers
- Looks most proportionate in a larger window; view beyond the window becomes more important
- Louvers almost disappear when open

Wood Louver Sizes

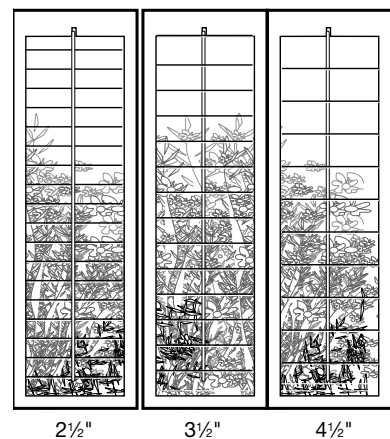

Options

Hardware Options

Select the hardware color that best fits your décor.

Hinge Colors

- Antique Brass
- Off White
- Oil Rubbed Bronze
- Satin Nickel
- Stainless Steel*
- White

*Surcharge, see price charts

Hide-A-Tilt™ Colors

(see color coordination chart in “Tilt Options: Hide-A-Tilt” section)

- Steel Grey
- White

NOTES:

1. Hide-A-Tilt color will default to shutter color but can be changed at time of order.
2. Bifold hinges are seen from the street side. On painted shutters the bifold hinge color will default to White or Off White to coordinate with paint color regardless of hardware color ordered.

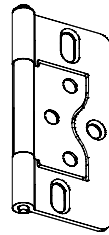

Frame Hinge

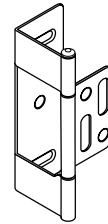

Hang Strip Hinge



Bifold Hinge

Panel Overlap Options

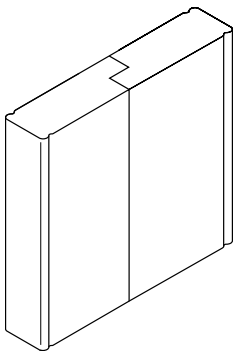

Rabbet Stile Panel Overlap

- Factory standard
- Right over left overlap only
- Left over right overlap not available

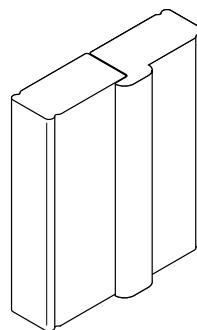

Astragal Stile Panel Overlap

- No charge option
- Right over left overlap standard
- Left over right overlap optional
- Astragal will automatically be used between bifold panels

Tilt Type Options: Overview

We offer four tilt type options – two with 1-way louver closure (up only) and two with 2-way louver closure (up and down).

1. Front Tilt 1-Way Closure (Up Only)
2. Front Tilt 2-Way Closure (Up/Down)
3. Hidden Tilt 1-Way Closure (Up Only)
4. Hidden Tilt 2-Way Closure (Up/Down)

Different rails are used for 1-way closure vs. 2-way closure, as shown to the right.

Shutter panels made with 1-way closure (up only) will have the tightest louver to louver closure.

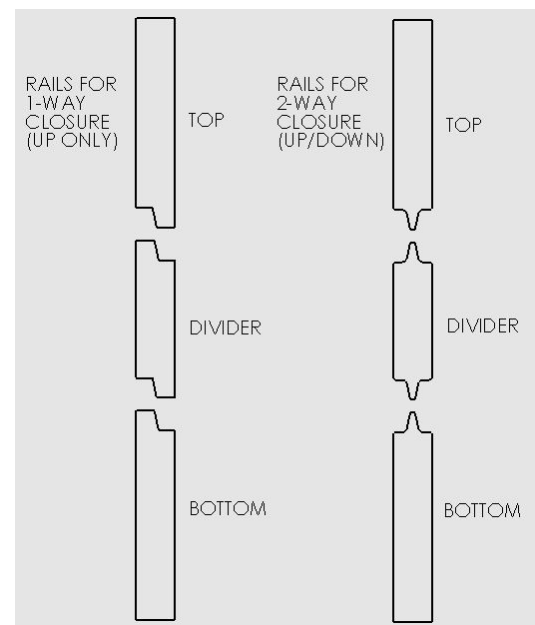

Options

Tilt Options: Front Tilt

A traditional tilt bar is located on the front center of the panel and is connected to the edge of the louvers with staples.

Important: The purpose of the tilt bar is to provide louver alignment, not for changing louver position or opening the shutter panel. Louvers should be opened/closed by grabbing onto one louver directly and the remaining louvers will follow.

1-Way Closure (Up Only) – Panels have a mouse hole on the rails above each louver section

- Panels with 1-way louver closure will have the tightest louver to louver closure, but in the upwards direction only

2-Way Closure (Up/Down) – Panels have mouse holes on the rails above and below each louver section

- Shutters with 2-way louver closure will allow the louvers to be closed up and down; however, louver to louver light gaps will be larger
- Shutters with 2-way louver closure will have better closure when louvers are in the upwards position vs. downwards position

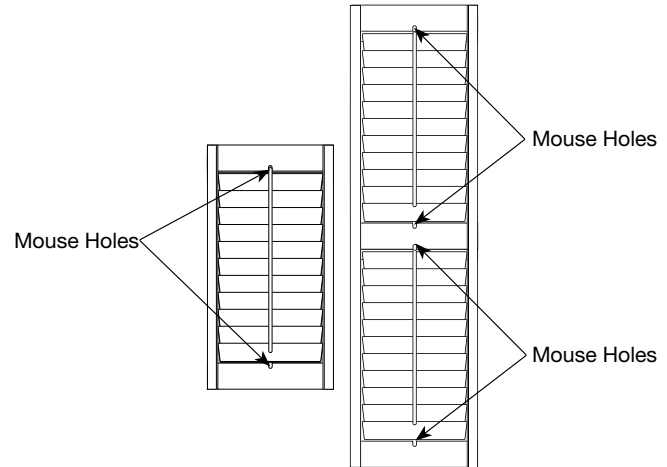
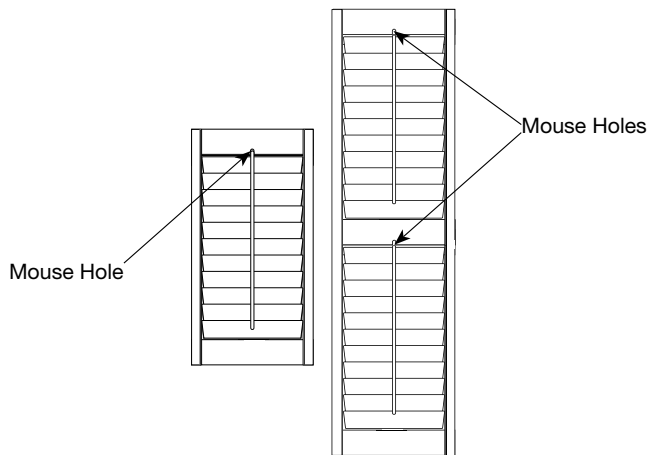

Tilt Options: Hide-A-Tilt™

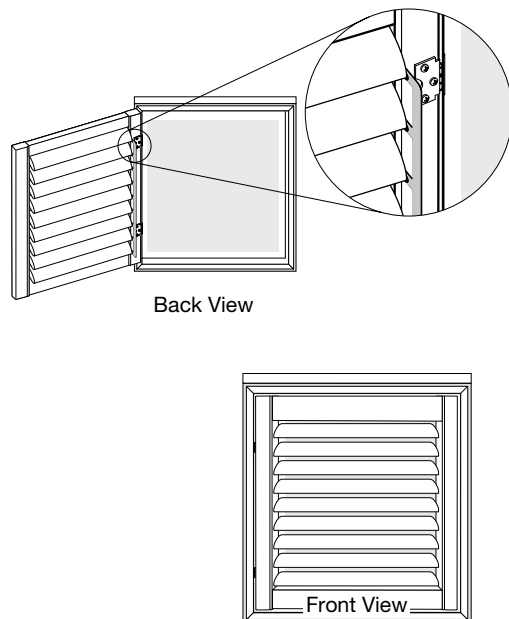

Hide-A-Tilt option – Includes the tilt mechanism on the back side of the shutter panel, eliminating the traditional front tilt bar to create an unobstructed view and clean linear appearance. A thin steel bar is attached to the louvers on the rear of the panel. Operation of the shutter is as simple as moving one louver into position, and all of the other louvers will follow.

- Available as 1-Way Closure (Up Only) and 2-Way Closure (Up/Down)
- Shutters with 1-way louver closure will have the tightest louver to louver closure, but in the upwards direction only
- Shutters with 2-way louver closure will allow the louvers to be closed up and down; however, louver to louver light gaps will be larger
- Shutters with 2-way louver closure will have better closure when louvers are in the upwards position vs. downwards position
- Hide-A-Tilt is mounted on hinge side for standard shutters and attached with screws
- No mouse hole in the panel
- Hide-A-Tilt bar color will default based on shutter color (see chart below) but can be manually changed at time of order
- Ordered heights over 60" require split tilt
- Hide-A-Tilt requires an additional $\frac{3}{8}$ " window clearance

Hide-A-Tilt™ Color Coordination Chart

Shutter Color	Default Hide-A-Tilt Color
Angora (1052)	Steel Grey
Antique White (1026)	Steel Grey
Base Black (1767)	Steel Grey
Base White (1051)	White
Base White* (2051)	White
Creamy White* (2729)	Steel Grey
Crisp White (1712)	White
Dover White (1683)	Steel Grey
Dovetail (1839)	Steel Grey
Grey Beige (1817)	Steel Grey
Medium Grey (1841)	Steel Grey
Pearl (1922)	White
Silk White* (2922)	White
Snow White (1909)	White
Snowflake (1603)	White
Stepping Stone (1889)	Steel Grey
Stucco (1963)	Steel Grey
All Stains	Steel Grey
All Custom Colors	Steel Grey

*Composite color match.

Tilt Options: Split Tilt

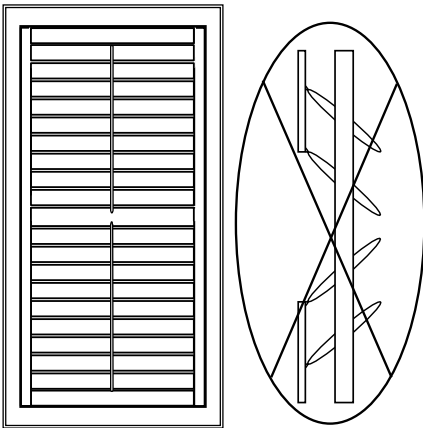

NOTE: Upper and lower louvers cannot be positioned at opposing angles because the edges of the louvers will touch.

Top and bottom rails may vary or be unequal due to requested locations and louver spacing.

Split Tilt

Splits one large louver set into two individually operated louver sets by attaching two separate tilt bars.

To measure split tilt, use bottom of frame reference point to desired split location. See measuring instructions in "Measuring Divider Rail or Split Tilt Location" section.

Split Tilt—Front Tilt Bar, No Divider Rail

- Split tilt can be requested centered or ordered location
- 3½" louver exact to ordered location
- 4½" louver may have up to 2" tolerance to ordered location
- 2½" louver not available (the front tilt will not allow the louvers to function properly)

Split Tilt—Hide-A-Tilt™ Bar, No Divider Rail

- Split tilt can be requested centered or ordered location
- 2½" and 3½" louver exact to ordered location
- 4½" louver may have up to 2" tolerance to ordered location

Split Tilt—Front Tilt Bar AND Divider Rail

- 3½" louver may cause split tilt to have up to 2" tolerance to ordered location when combined with a divider rail; divider rail location will be exact
- Split tilt can only be requested above OR below divider rail, not both
- Split tilt can be requested centered or ordered location
- 2½" louver not available (the front tilt will not allow the louvers to function properly)

Split Tilt—Hide-A-Tilt Bar AND Divider Rail

- 2½" and 3½" may cause split tilt to have 2" tolerance to ordered location when combined with a divider rail; divider rail location will be exact
- 4½" louver may cause split tilt AND divider rail to have up to 2" tolerance to ordered location
- Split tilt can only be requested above OR below divider rail, not both
- Split tilt can be requested centered or ordered location

Options

Divider Rail Requirements

Splits one large louver set into two individually operated louver sets by adding a horizontal rail. It is used to add strength to tall panels or add a decorative element.

- Divider rails are required over 84" height for added strength
- Divider rail can be requested (when not required) for design purposes
- A 3" divider rail is used with 2½" and 3½" louvers
- A 4" divider rail is used with 4½" louvers
- Minimum louver set between rails is two louvers
- Two divider rails are available per shutter, but never required
- Divider rails for 2½" and 3½" louvers will be exact to ordered location
- Divider rails for 4½" louvers may have up to 2" tolerance to ordered location to achieve uniform louver spacing
- All arch/angle panels may only have one divider rail and may have up to 2" tolerance to ordered location

IMPORTANT INFORMATION: Top and bottom rail sizes may vary and/or be unequal in size due to a specified divider rail location. Rail sizes will vary from 3" to 6" based on order specifications. **If shutters are in the same room and/or side by side, it is critical to order them at the same exact height to ensure divider rail locations and rail heights match.** Please reference the Louver Count/Rail Height Calculator on Graberdirect.com to ensure satisfaction before order is placed

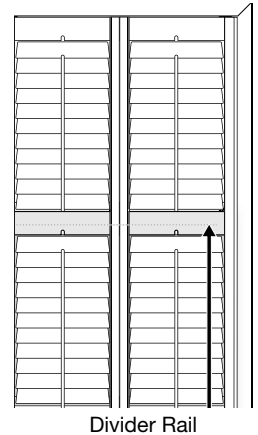

Measuring Divider Rail or Split Tilt Location

Always start from the bottom point of measure to center of the desired divider rail or split tilt location.

To measure frame-to-frame, measure from the bottom of the shutter frame up to the center of the desired rail or split tilt location.

To measure window opening, measure from the sill or bottom of the window opening to the center of the desired rail or split tilt location.

IMPORTANT CONSIDERATIONS

Rail sizes—Top and bottom rail sizes may vary in the same shutter due to requested location of the divider rail/split tilt and louver spacing.

Same room shutters—If shutters are in the same room, they should be ordered with the same height and options to ensure rail sizes match. Varying heights will result in inconsistent rail sizes and/or louver counts.

- If ordering direct mount or hang strip, you may request to align either top or bottom rails of uneven shutters at time of order; opposite rails of shutter and louver count may not match

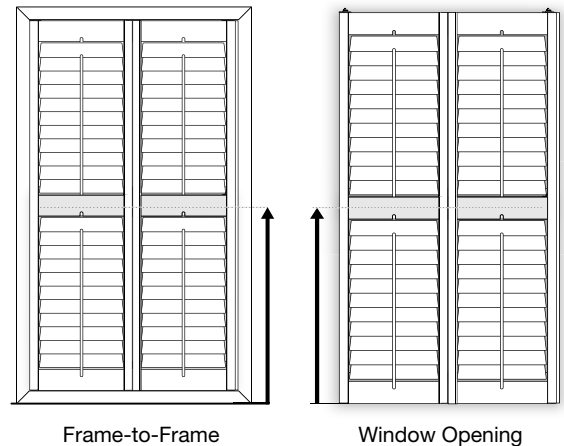

NOTE: Divider rail/split tilt locations may fluctuate if ordering rail alignment.

Measuring T-Post Locations

Always start from the left point of measure type to the center of the desired T-post location.

To measure frame-to-frame, measure from the left of the shutter frame to the center of the desired T-post location.

To measure window opening, measure from the left inside of the window opening to the center of the desired T-post location.

If there is more than one T-post, measure from the left of measure type to the center of first T-post location, then measure from the left of measure type over to the center of the second T-post location, etc. EXAMPLE: A-B, A-C, A-D

ALWAYS measure from the same point the frame was measured.

EXAMPLE: If measuring for L-frame, frame-to-frame measure type, A is the outside edge of the L-frame.

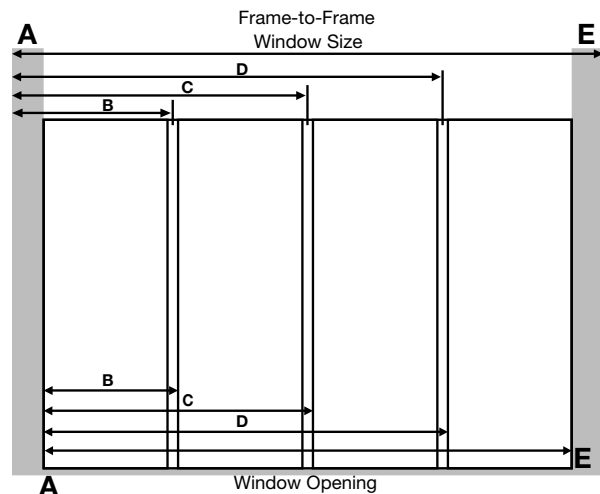

Options

Standard Shutters Wood Panel Configurations (only configurations available)

Single Panel



Two Panels

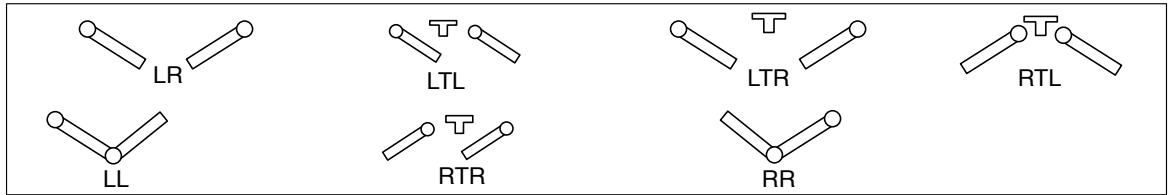

Three Panels

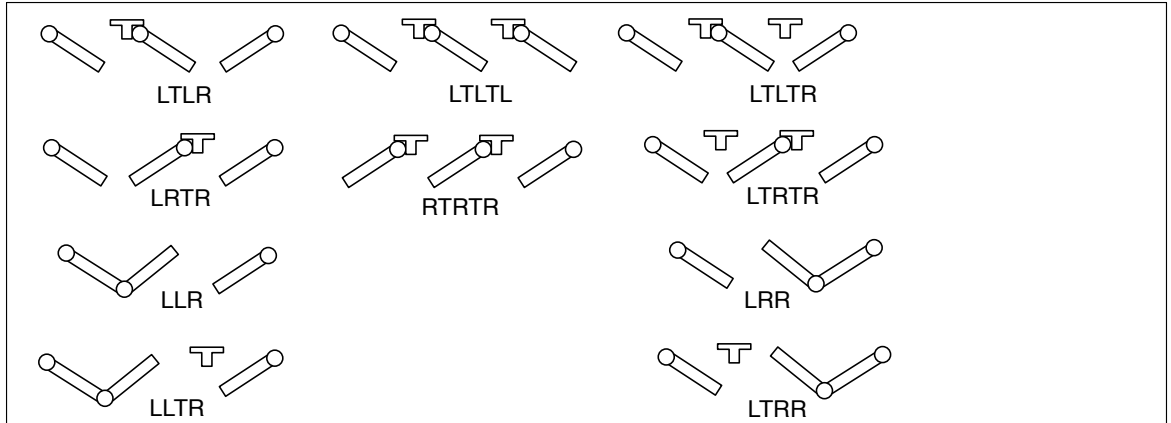

Four Panels

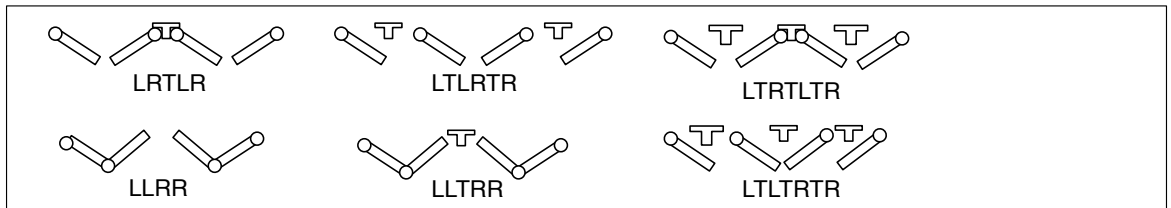

Five Panels

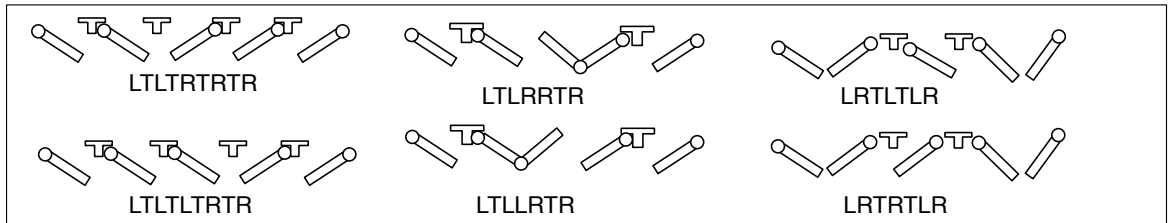

Six Panels

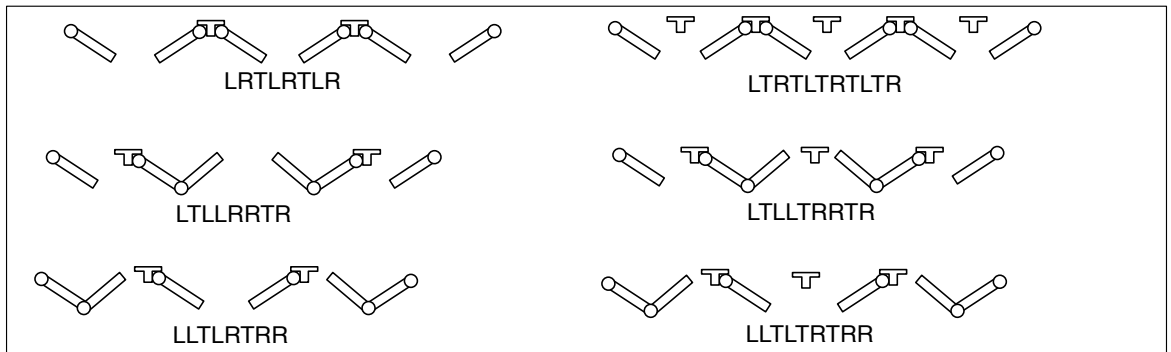

Eight Panels

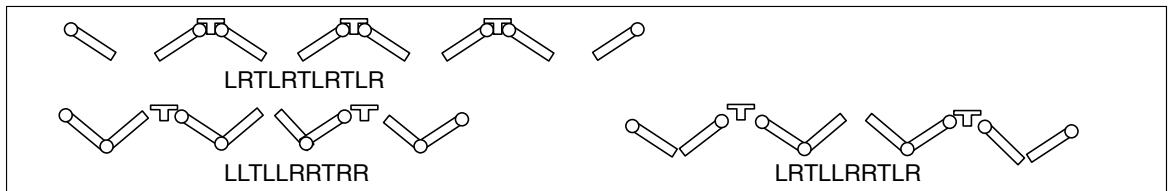

Options

Wood Frame Configurations

2-Sided

Hang strip and direct mount with inside mount is available only in 2-sided frame (vertical). Light block included at no charge.

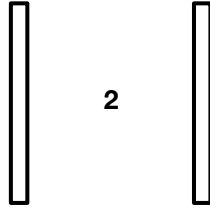

4-Sided with Sill Bottom

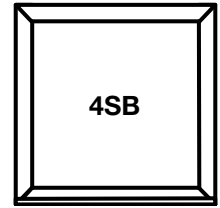

3-Sided

Light block included at no charge.

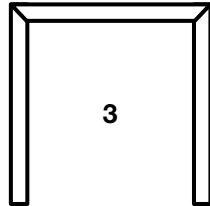

4-Sided with Sill Top

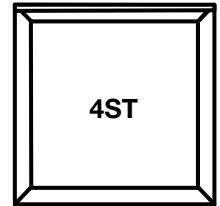

3-Sided Inverted

Light block included at no charge.

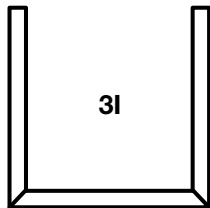

4-Sided

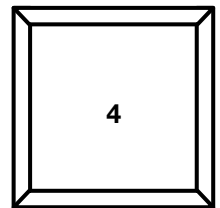

3-Sided with Sill Top

Light block included at no charge.

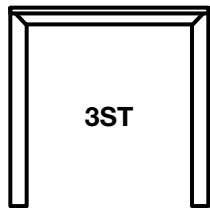

4-Sided with Sill Top and Bottom

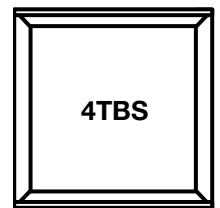

3-Sided Inverted with Sill Bottom

Light block included at no charge.

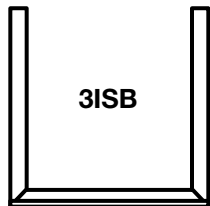

4-Sided with Sill Top and Sill Cap Bottom

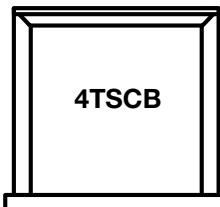

3-Sided Inverted with Sill Cap Bottom

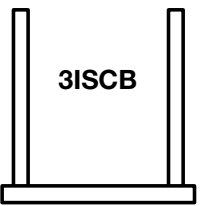

4-Sided with Sill Cap Bottom

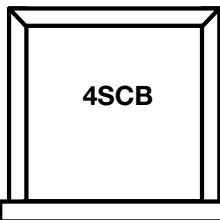

NOTE: Direct mount includes four light blocks at no charge.

Sill cap configurations not available on any ¼ arches and any angles or arch top panels with configurations over 5 panels

Options

Frame Product Detail

NOTE: Frames larger than 105" ordered size will be spliced.

Direct Mount

- Inside mount only
- Window opening measure only
- Panel is prehinged
- Four light blocks included
- Factory automatically makes deductions:
Width— $\frac{3}{16}$ ", Height— $\frac{1}{4}$ "

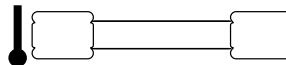
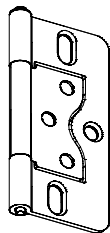

Example: 1 Panel L

Frame Hinge

Hang Strip

- Inside mount only
- Window opening measure only
- Includes adjustable wraparound hinge for easy installation
- Panel and hang strip are prehinged
- Hang strip is predrilled
- Top and bottom light blocks included
- Factory automatically makes deductions:
Width— $\frac{3}{16}$ ", Height— $\frac{1}{4}$ "

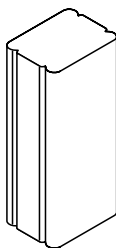

Hang Strip

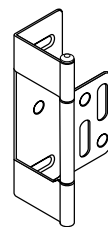
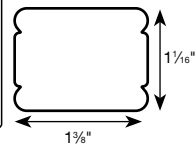

Hang Strip Hinge

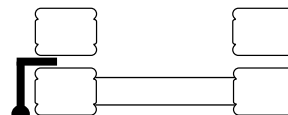

Example: 1 Panel L

Z-Frames

- Inside mount only
- Window opening measure only
- Panel and frame are prehinged
- Frame is not predrilled
- Standard, signature, legacy, bullnose, craftsman—factory automatically makes deductions:
Width— $\frac{5}{16}$ "; for Height see chart in "Deductions for Frame Allowances" section
- Tilt-out Z-frame—factory makes no deductions, measurement is the same as the window opening, see "Proper Application of the Tilt-Out Z-Frame" section

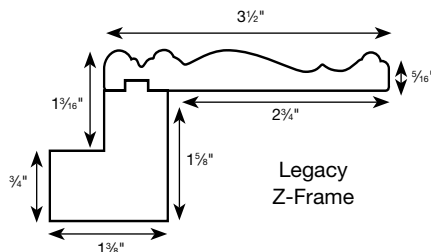

Legacy Z-Frame

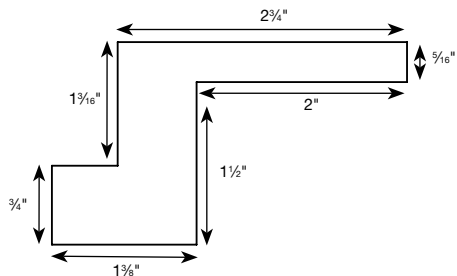

Craftsman Z-Frame

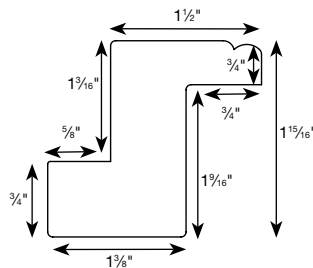

Standard Z-Frame

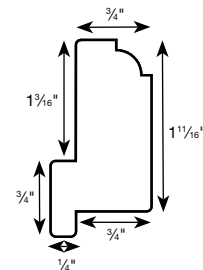

Tilt-Out Z-Frame

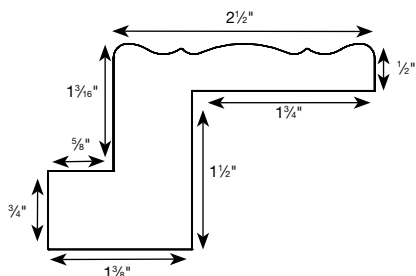

Signature Z-Frame

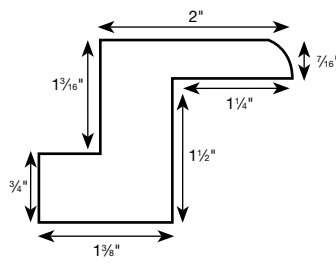

Bullnose Z-Frame

Options

Frame Product Detail

NOTE: Frames larger than 105" ordered size will be spliced.

Deco Frames

- Outside mount only
- Frame-to-frame measure only
- Panel and frame are prehinged
- Frame is not predrilled
- No factory deduction made
 - If using for inside mount or in a tight spot, installer must make own deduction for proper fit and order as frame-to-frame

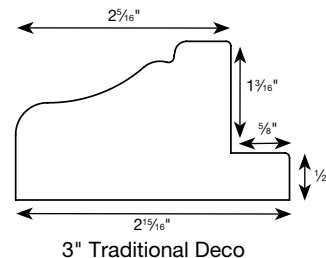
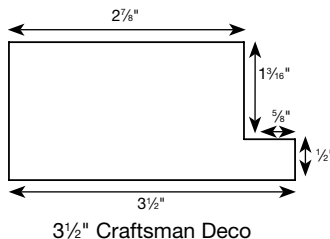
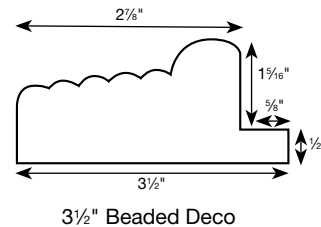
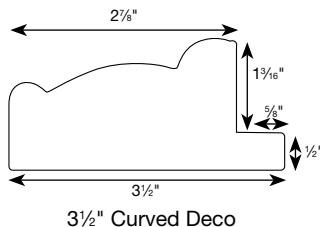

L-Frames

- Recommended outside mount
- Frame-to-frame measure only
- Panel and frame are prehinged
- Frame is not predrilled
- No factory deduction made
 - If using for inside mount or in a tight spot, installer must make own deduction for proper fit and order as frame-to-frame

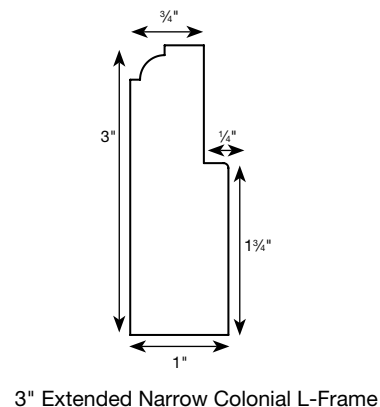
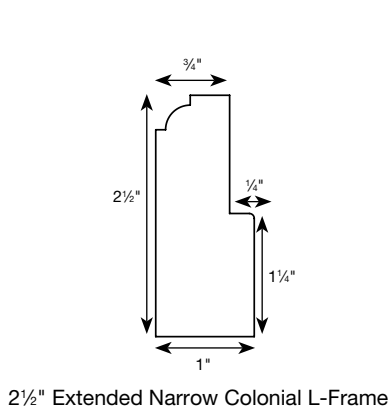
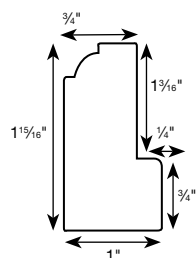
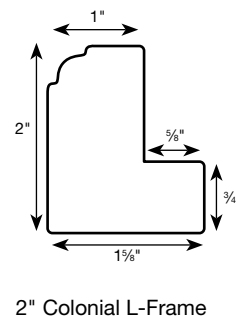
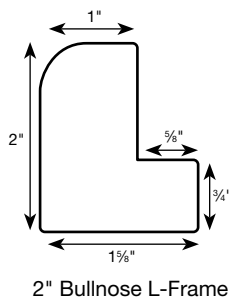
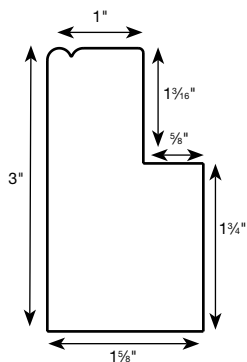
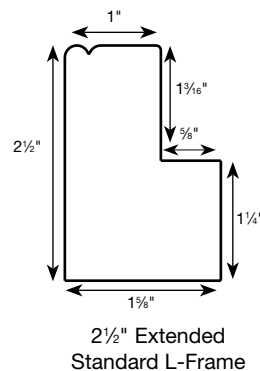
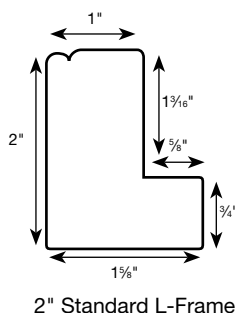

Options

Frame Product Detail

NOTE: Frames larger than 105" ordered size will be spliced.

Sill Frames

- Offered with L-, Z-, and deco frames
- Not available with buildouts
- Sill frames are mitered to fit side frames and attached via 1/2" Hoffman keys

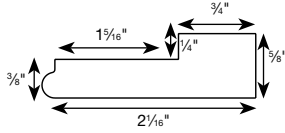

Narrow Colonial L Sill Frame

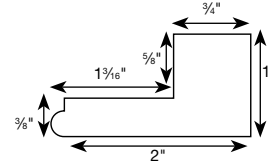

L and Z Sill Frame

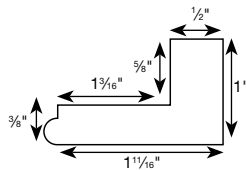

Deco Sill Frame

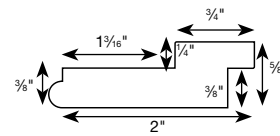

Tilt Z Sill Frame

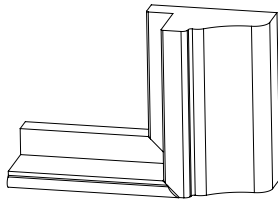

Wood Traditional Deco Frame with Sill

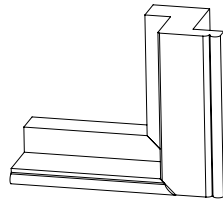

Wood Z-Frame with Sill

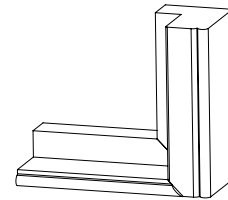

Wood L-Frame with Sill

Sidelight Frame

- Frame-to-frame measure only
- 4-sided configuration only
- Left or right panel configurations only
- 2 1/2" or 3 1/2" louvers only
- Frame shipped assembled
- Buildout available, attached at factory
- See "Sidelight" section for more information

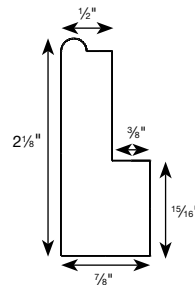

Sidelight Frame

Sill Cap

- Available with all frames
- Available with following frame configurations: 3-sided inverted with sill cap bottom, 4-sided with sill cap bottom, 4-sided with sill frame top, and sill cap bottom
- Buildout included (1 5/8" x 1/2") for inside mount frames
- Not available on 1/4 arches, 1/4 arch panels, any angles, or any arch top panel with configuration over 5 panels

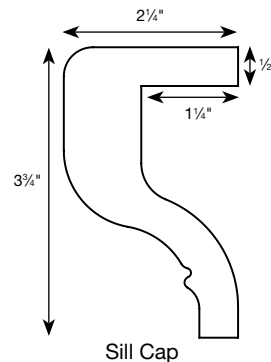

Sill Cap

Options

Frame Product Detail

NOTE: Frames larger than 105" ordered size will be spliced.

Light Block

- Included with hang strip, direct mount, 2-sided, and 3-sided frame types

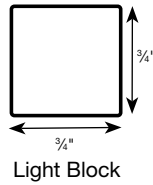

Light Block

T-Post

- Post that divides the shutter into multiple sections
- T-posts are predrilled by factory
- Horizontal post available with double hung
- T-post L-bracket included on hang strip and direct mount

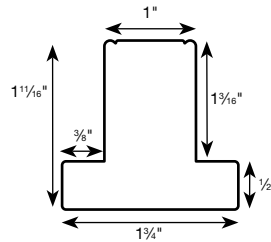

Deco T-Post

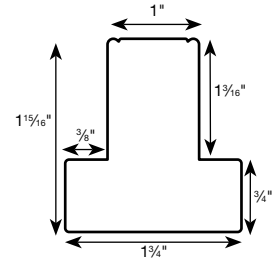

Standard T-Post

Buildout

- Used with L-frames, deco frames, Z-frames, sidelight frames, and sill caps
- Available only in 1/2" thickness
- Maximum 1/2" (one piece) per shutter for sidelight frames and bypass/bifold
- Maximum 1" (two pieces) per shutter for Z-frames
- Maximum 2" (four pieces) per shutter for L-frames and deco frames
- Not available with sill configurations

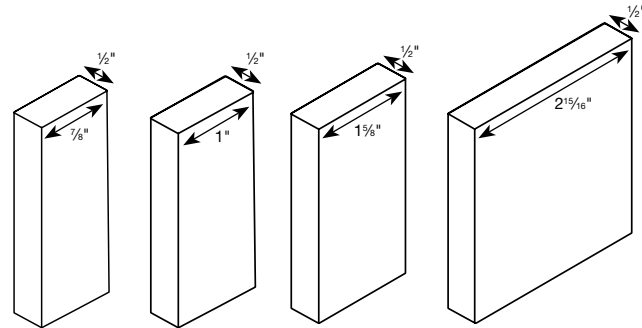

Sidelight Buildout

Narrow Colonial L-Frame Buildout

L-Frame/Sill Cap/Bypass/Bifold Buildout

Traditional Deco Buildout

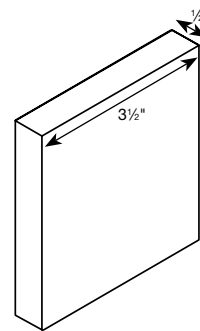

All Other Deco Buildouts

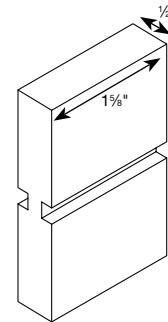

Z-Frame Buildout

Corner Posts and Bay Posts

- A vertical post used for installing shutters in bay and corner windows
- See "Corner Windows" and "Bay Windows" sections for more information

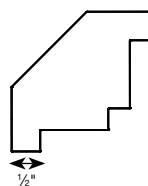

Deco 1/2" Corner Post

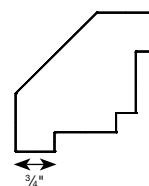

Standard 3/4" Corner Post

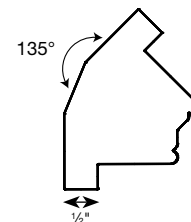

Deco 1/2" Bay Post

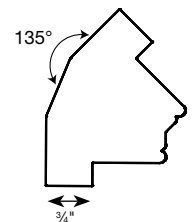

Standard 3/4" Bay Post

Specifications

Proper Application of the Tilt-Out Z-Frame

Tilt-Out Z-Frame (inside mount)

Designed to be used with certain styles of window trim. Panel and frame are prehinged. Frame is not predrilled. Shipment includes self-tapping trim-head screws.

Tilt-out Z-frame must be ordered as "Window Opening" (WO) size. NO factory deduction is made with this frame.

Factory Deductions: Width: 0"

Height: 0"

NOTE: Installer MUST make own deductions for proper fit. If diagonal measurements exceed $\frac{1}{8}$ " out of square, use other outside mount frame style.

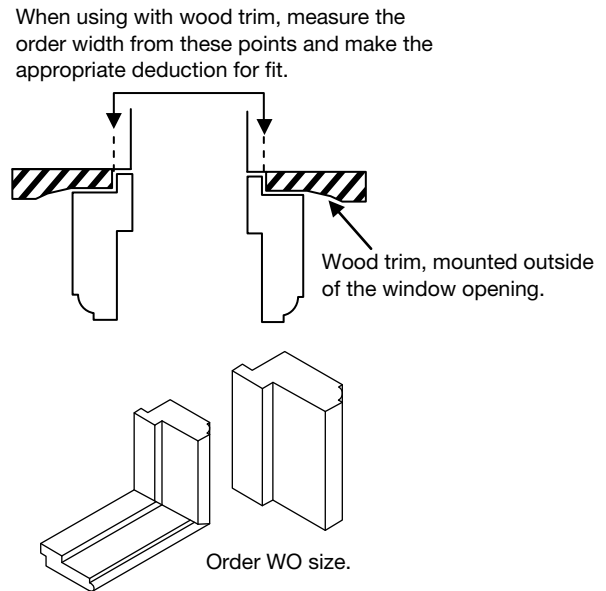

Tilt-Out Z-Frame with Sill Frame

Sill Cap Application

Ordering Options

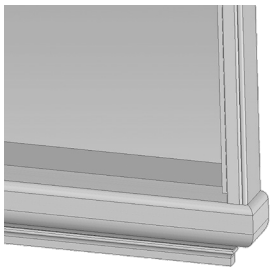

Flush with Frame

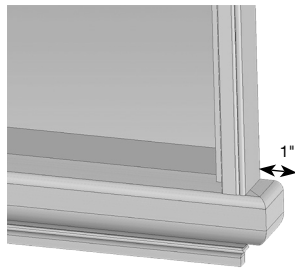

1" Overlap Per Side

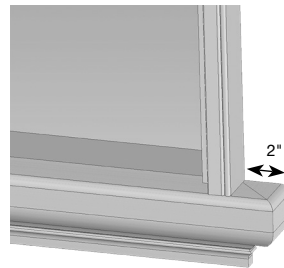

2" Overlap Per Side



Specified Cap Length

Three Available Frame Configuration Options

- 3-sided inverted with sill cap bottom
- 4-sided with sill cap bottom
- 4-sided with sill frame top and sill cap bottom

Existing sill length on window will be required when ordering. This is to assure that sill cap option ordered will fit over the top of your existing window sill. A $1\frac{5}{8}$ " buildout will be provided to take up the gap between the existing sill and any inside mount frame. This buildout will be butted up to the back edge of the sill cap to extend the depth. Sill cap cannot be used if existing window sill has apron.

The sill cap will sit flush against the wall for window sills protruding up to $1\frac{1}{4}$ " from the face of the wall. The sill cap can be used on deeper sills but there will be a gap between the wall and the sill cap.

No mounting hardware included. Adhesive should be used to attach sill cap to window sill.

NOTE: Not available on sunburst arches, bay, corner, sidelight, $\frac{1}{4}$ arches, $\frac{1}{4}$ arch panels, any angles, or arch top panels with configurations over 5 panels.

Specifications

Deductions for Frame Allowances

Direct Mount

- Automatically taken at factory
- Width deduction— $\frac{3}{16}$ "
- Height deduction— $\frac{1}{4}$ "

Hang Strip

- Automatically taken at factory
- Width deduction— $\frac{3}{16}$ "
- Height deduction— $\frac{1}{4}$ "

Z-Frame (all Z-frames, except Tilt Out Z-frame)

- Automatically taken at factory
- See chart below for width and height deductions

Z-Frame Configuration	Frame Width Deduction (inches)	Frame Height Deduction (inches)
2-Sided	- $\frac{5}{16}$	No deduction*
3-Sided or 3-Sided Inverted	- $\frac{5}{16}$	- $\frac{5}{32}$ *
3-Sided Sill Top or Bottom	- $\frac{5}{16}$	- $\frac{1}{16}$ *
3-Sided Inverted with Sill Cap Bottom	- $\frac{5}{16}$	- $\frac{1}{16}$ *
4-Sided	- $\frac{5}{16}$	- $\frac{5}{16}$
4-Sided Sill Top or Bottom	- $\frac{5}{16}$	- $\frac{5}{32}$
4-Sided Sill Top and Bottom	- $\frac{5}{16}$	- $\frac{1}{16}$
4-Sided Sill Top and Sill Cap Bottom	- $\frac{5}{16}$	- $\frac{1}{16}$
4-Sided Sill Cap Bottom	- $\frac{5}{16}$	- $\frac{5}{32}$

*Using this deduction, panel clearance on open ends of frame will automatically be $\frac{1}{8}$ ".

NOTE: Factory makes no deductions on tilt-out Z-frames; the measurement is the same as the window opening (see "Proper Application of the Tilt-Out Z-Frame" section). You must take your own deductions on tilt-out Z-frames.

L-Frame

- No deductions taken at factory
- If using for inside mount or in a tight spot, installer must make own deduction for proper fit and order as frame-to-frame

Traditional Deco Frame

- No deductions taken at factory
- If using in a tight spot, installer must make own deduction for proper fit and order as frame-to-frame

Installation Hardware

Included with Order

- Hinge pins
- Hoffman keys
- Installation screws (hinge, mounting, etc.)
- T-post L-bracket (if required)
- Touch up paint dabber—paints only; due to top coat process, touch-up bottles are NOT provided with stains but can be requested

Available Upon Request—Contact Customer Service

- Hinge shims
- Extra louver pins
- Extra screws
- Screw caps (cover exposed screw heads)

Size Considerations

All Louver Sizes: Minimum and Maximum (order width by panel configuration)

Number of Panels	Panel Configurations	Direct Mount, Hang Strip, Tilt-Out Z-Frame		Z-Frame		L-Frame		Narrow Colonial L-Frame		3" Traditional Deco Frame		3½" Curved, Beaded, Craftsman, Deco Frame	
		Order WO Size		Order WO Size		Order F-F Size		Order F-F Size		Order F-F Size		Order F-F Size	
		Minimum Width (inches)	Maximum Width (inches)	Minimum Width (inches)	Maximum Width (inches)	Minimum Width (inches)	Maximum Width (inches)	Minimum Width (inches)	Maximum Width (inches)	Minimum Width (inches)	Maximum Width (inches)	Minimum Width (inches)	Maximum Width (inches)
1 Panel	L, R*	9 ³ / ₁₆	36 ³ / ₁₆	11	38	11 ³ / ₁₆	38 ³ / ₁₆	10 ¹ / ₁₆	37 ¹ / ₁₆	13 ¹³ / ₁₆	40 ¹³ / ₁₆	14 ¹⁵ / ₁₆	41 ¹⁵ / ₁₆
2 Panels	LR*	18 ¹ / ₁₆	72 ¹ / ₁₆	19 ⁹ / ₁₆	73 ³ / ₁₆	20 ¹ / ₁₆	74 ¹ / ₁₆	19 ⁹ / ₁₆	73 ³ / ₁₆	22 ¹¹ / ₁₆	76 ¹¹ / ₁₆	23 ¹³ / ₁₆	77 ¹³ / ₁₆
	LTR, LTL, RTR, RTL*	19 ⁹ / ₁₆	73 ³ / ₁₆	21 ³ / ₁₆	75 ³ / ₁₆	21 ³ / ₁₆	75 ³ / ₁₆	20 ⁷ / ₁₆	74 ⁷ / ₁₆	24	78	25 ⁵ / ₁₆	79 ⁹ / ₁₆
	LL, RR*	18 ¹ / ₁₆	52 ¹ / ₁₆	19 ⁹ / ₁₆	53 ³ / ₁₆	20 ¹ / ₁₆	54 ¹ / ₁₆	19 ⁹ / ₁₆	53 ¹⁵ / ₁₆	22 ¹¹ / ₁₆	56 ¹¹ / ₁₆	23 ¹³ / ₁₆	57 ¹³ / ₁₆
3 Panels	LLR, LRR*	27 ¹ / ₄	78 ³ / ₄	29 ¹ / ₁₆	80 ¹ / ₁₆	29 ¹ / ₄	80 ¹ / ₄	28 ³ / ₄	79 ³ / ₄	31 ⁷ / ₁₆	82 ⁷ / ₁₆	33	84
	LLTR, LTRR*	28 ¹ / ₄	89 ³ / ₄	30 ¹ / ₁₆	91 ¹ / ₁₆	30 ¹ / ₄	91 ¹ / ₄	29 ³ / ₄	90 ³ / ₄	32 ⁷ / ₁₆	93 ⁷ / ₁₆	34	95
	LTLR, LRTR*	28 ¹ / ₄	109 ³ / ₄	30 ¹ / ₁₆	111 ¹ / ₁₆	30 ¹ / ₄	111 ¹ / ₄	29 ³ / ₄	110 ³ / ₄	32 ⁷ / ₁₆	113 ⁷ / ₁₆	34	115
	LTLTR, LTRTR, LTLTL, RTRTR*	29 ¹ / ₁₆	110 ¹ / ₁₆	31 ³ / ₁₆	112 ³ / ₁₆	31 ³ / ₁₆	112 ³ / ₁₆	31 ¹ / ₁₆	112 ¹ / ₁₆	34 ³ / ₁₆	115 ³ / ₁₆	35 ⁵ / ₁₆	116 ⁵ / ₁₆
4 Panels	LLRR*	36 ⁵ / ₁₆	104 ⁵ / ₁₆	38 ⁷ / ₁₆	106 ⁷ / ₁₆	38 ⁵ / ₁₆	106 ⁵ / ₁₆	37 ¹³ / ₁₆	105 ¹³ / ₁₆	40 ¹⁵ / ₁₆	108 ¹⁵ / ₁₆	42 ¹ / ₁₆	110 ¹ / ₁₆
	LLRR*	37 ¹ / ₁₆	105 ⁵ / ₁₆	38 ¹⁵ / ₁₆	106 ¹⁵ / ₁₆	39 ⁹ / ₁₆	107 ⁹ / ₁₆	38 ⁵ / ₁₆	106 ⁵ / ₁₆	41 ³ / ₄	109 ³ / ₄	42 ⁷ / ₁₆	110 ⁷ / ₁₆
	LRTLRL*	37 ¹ / ₁₆	145 ⁵ / ₁₆	38 ¹⁵ / ₁₆	146 ¹⁵ / ₁₆	39 ⁹ / ₁₆	147 ⁹ / ₁₆	38 ⁵ / ₁₆	146 ⁵ / ₁₆	41 ³ / ₄	149 ³ / ₄	42 ⁷ / ₁₆	150 ⁷ / ₁₆
	LTLRTR*	38 ⁷ / ₁₆	146 ⁷ / ₁₆	40 ¹ / ₄	148 ¹ / ₄	40 ⁷ / ₁₆	148 ⁷ / ₁₆	39 ¹⁵ / ₁₆	147 ¹⁵ / ₁₆	43 ¹ / ₁₆	151 ¹ / ₁₆	44 ³ / ₁₆	152 ³ / ₁₆
	LRTLTR, LTLRTR*	39 ³ / ₄	147 ³ / ₄	41 ⁹ / ₁₆	149 ⁹ / ₁₆	41 ³ / ₄	149 ³ / ₄	41 ¹ / ₄	149 ¹ / ₄	44 ³ / ₈	152 ³ / ₈	45 ¹ / ₂	153 ¹ / ₂
5 Panels	LTLRTR, LTLRTR*	47 ⁵ / ₁₆	162 ⁵ / ₁₆	51 ¹ / ₄	166 ¹ / ₄	51 ⁵ / ₁₆	166 ⁵ / ₁₆	51 ⁵ / ₁₆	166 ⁵ / ₁₆	56 ⁷ / ₁₆	171 ⁷ / ₁₆	59 ⁹ / ₁₆	174 ⁹ / ₁₆
	LRTLRL, LRTLRL*	47 ⁵ / ₁₆	182 ⁵ / ₁₆	50 ¹⁵ / ₁₆	185 ¹⁵ / ₁₆	51 ³ / ₁₆	189 ³ / ₁₆	50 ¹¹ / ₁₆	188 ¹¹ / ₁₆	54 ¹³ / ₁₆	194 ¹³ / ₁₆	59 ¹¹ / ₁₆	195 ¹¹ / ₁₆
	LTLRTR, LTLRTR*	49 ¹⁵ / ₁₆	184 ¹⁵ / ₁₆	53 ⁹ / ₁₆	188 ⁹ / ₁₆	53 ¹⁵ / ₁₆	188 ¹⁵ / ₁₆	53 ⁷ / ₁₆	188 ⁷ / ₁₆	57 ⁹ / ₁₆	193 ⁹ / ₁₆	60 ¹ / ₁₆	195 ¹ / ₁₆
6 Panels	LTLRTRR	56 ³ / ₁₆	178 ³ / ₁₆	58	180	58 ³ / ₁₆	180 ³ / ₁₆	57 ¹¹ / ₁₆	179 ¹¹ / ₁₆	60 ¹³ / ₁₆	182 ¹³ / ₁₆	61 ¹⁵ / ₁₆	183 ¹⁵ / ₁₆
	LTLRTRR	56 ¹ / ₁₆	178 ¹ / ₁₆	58 ¹ / ₂	180 ¹ / ₂	58 ¹¹ / ₁₆	180 ¹¹ / ₁₆	58 ³ / ₁₆	180 ³ / ₁₆	61 ⁵ / ₁₆	183 ⁵ / ₁₆	62 ⁷ / ₁₆	184 ⁷ / ₁₆
	LRTLRLR	56 ³ / ₁₆	218 ³ / ₁₆	58	220	58 ³ / ₁₆	220 ³ / ₁₆	57 ¹¹ / ₁₆	219 ¹¹ / ₁₆	60 ¹³ / ₁₆	222 ¹³ / ₁₆	61 ¹⁵ / ₁₆	223 ¹⁵ / ₁₆
	LTLRTRR, LTLRTRR*	57 ¹ / ₂	179 ¹ / ₂	59 ⁹ / ₁₆	181 ⁹ / ₁₆	59 ¹ / ₂	181 ¹ / ₂	59	181	62 ⁷ / ₁₆	184 ⁷ / ₁₆	63 ⁹ / ₁₆	185 ⁹ / ₁₆
	LRTLRLR	60 ¹ / ₁₆	222 ¹ / ₁₆	61 ¹⁵ / ₁₆	223 ¹⁵ / ₁₆	62 ⁷ / ₁₆	224 ⁷ / ₁₆	61 ⁵ / ₁₆	233 ⁵ / ₁₆	64 ³ / ₄	226 ³ / ₄	65 ⁵ / ₁₆	227 ⁵ / ₁₆
8 Panels	LRTLRLR	73 ¹⁵ / ₁₆	249 ¹⁵ / ₁₆	75 ³ / ₄	251 ³ / ₄	75 ¹⁵ / ₁₆	251 ¹⁵ / ₁₆	75 ⁷ / ₁₆	251 ⁷ / ₁₆	78 ⁹ / ₁₆	254 ⁹ / ₁₆	79 ¹¹ / ₁₆	255 ¹¹ / ₁₆
	LTLRTRR	73 ¹⁵ / ₁₆	209 ¹⁵ / ₁₆	75 ³ / ₄	211 ³ / ₄	75 ¹⁵ / ₁₆	211 ¹⁵ / ₁₆	75 ⁷ / ₁₆	211 ⁷ / ₁₆	78 ⁹ / ₁₆	214 ⁹ / ₁₆	79 ¹¹ / ₁₆	215 ¹¹ / ₁₆
	LRTLRLR	75 ¹ / ₄	291 ¹ / ₄	77 ¹ / ₁₆	293 ¹ / ₁₆	77 ¹ / ₄	293 ¹ / ₄	76 ³ / ₄	292 ³ / ₄	79 ⁵ / ₁₆	295 ⁵ / ₁₆	81	297

*Panel configurations available in double hung.

NOTE: Frames larger than 105" ordered size will be spliced.

Size Considerations

Standard Shutters: Minimum and Maximum (order height by frame type and louver size)

Measure Type	Frame Configuration	Frame Type	Minimum (inches)			Maximum (inches)
			Louver Size			Louver Size
			2½	3½	4½	2½, 3½, 4½
Window Opening	2-sided	Direct mount/hang strip	10¼	12¼	14¼	120¼
	3-sided inverted with sill cap bottom		10¾	12¾	14¾	119¼
	2-sided	Z-frame (except tilt-out)	10¼	12¼	14¼	120¼
	3-sided and 3-sided inverted		11⅞	13⅞	15⅞	121⅞
	3-sided sill top or bottom		11½	13½	15½	121½
	3-sided inverted with sill cap bottom		10¾	12¾	14¾	120¾
	4-sided		12⅞	14⅞	16⅞	122⅞
	4-sided with sill top or bottom		11⅞	13⅞	15⅞	121⅞
	4-sided with sill top and bottom		11	13	15	121
	4-sided with sill cap bottom		11⅞	13⅞	15⅞	121⅞
	4-sided with sill frame top and sill cap bottom		11⅞	13⅞	15⅞	121⅞
	2-sided		Tilt-out Z-frame	10¼	12¼	14¼
	3-sided and 3-sided inverted	10⅝		12⅝	14⅝	120⅝
	3-sided sill top or bottom	11⅝		13⅝	15⅝	121⅝
	3-sided inverted with sill cap bottom	10¾		12¾	14¾	120¾
	4-sided	11⅞		13⅞	15⅞	121⅞
	4-sided with sill top or bottom	10⅞		12⅞	14⅞	120⅞
	4-sided with sill top and bottom	11		13	15	121
4-sided with sill cap bottom	10¾	12¾		14¾	120¾	
4-sided with sill frame top and sill cap bottom	11⅞	13⅞	15⅞	121⅞		
Frame-to-Frame	2-sided	L-frame (except narrow colonial)	10¼	12¼	14¼	120¼
	3-sided and 3-sided inverted		11¼	13¼	15¼	121¼
	3-sided sill top or bottom		11⅞	13⅞	15⅞	121⅞
	3-sided inverted with sill cap bottom		10¾	12¾	14¾	120¾
	4-sided		12¼	14¼	16¼	122¼
	4-sided with sill top or bottom		11¼	13¼	15¼	121¼
	4-sided with sill top and bottom		11	13	15	121
	4-sided with sill cap bottom		11¼	13¼	15¼	121¼
	4-sided with sill frame top and sill cap bottom		11⅞	13⅞	15⅞	121⅞
	2-sided		Narrow colonial L-frame	10¼	12¼	14¼
	3-sided and 3-sided inverted	11		13	15	121
	3-sided sill top or bottom	11⅞		13⅞	15⅞	121⅞
	3-sided inverted with sill cap bottom	10¾		12¾	14¾	120¾
	4-sided	11¼		13¼	15¼	121¼
	4-sided with sill top or bottom	11½		13½	15½	121½
	4-sided with sill top and bottom	11		13	15	121
	4-sided with sill cap bottom	11½		13½	15½	121½
	4-sided with sill frame top and sill cap bottom	11⅞		13⅞	15⅞	121⅞
	2-sided	3½" deco frame (curved, beaded, and craftsman)		10¼	12¼	14¼
	3-sided and 3-sided inverted		13⅞	15⅞	17⅞	123⅞
	3-sided sill top or bottom		10⅞	12⅞	14⅞	120⅞
	3-sided inverted with sill cap bottom		10¾	12¾	14¾	120¾
	4-sided		16	18	20	126
	4-sided with sill top or bottom		13½	15½	17½	123½
	4-sided with sill top and bottom		11	13	15	121
	4-sided with sill cap bottom		14¼	16¼	18¼	124¼
	4-sided with sill frame top and sill cap bottom		11⅞	13⅞	15⅞	121⅞
	2-sided		3" deco frame (traditional)	10¼	12¼	14¼
	3-sided and 3-sided inverted	12⅞		14⅞	16⅞	122⅞
	3-sided sill top or bottom	10⅞		12⅞	14⅞	120⅞
3-sided inverted with sill cap bottom	10¾	12¾		14¾	120¾	
4-sided	14⅞	16⅞		18⅞	124⅞	
4-sided with sill top or bottom	12⅝	14⅝		16⅝	122⅝	
4-sided with sill top and bottom	11	13		15	121	
4-sided with sill cap bottom	13⅞	15⅞		17⅞	123⅞	
4-sided with sill frame top and sill cap bottom	11⅞	13⅞		15⅞	121⅞	
4-sided	Sidelight	11¼		13¼	N/A	97¼

NOTE: Frames larger than 105" ordered size will be spliced.

Specialty Styles

Café Shutters

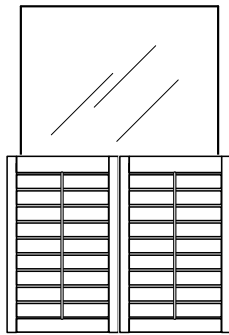

Shown as 2-Sided

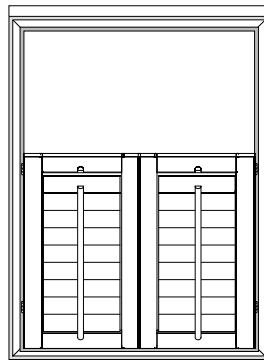

Shown as 4-Sided

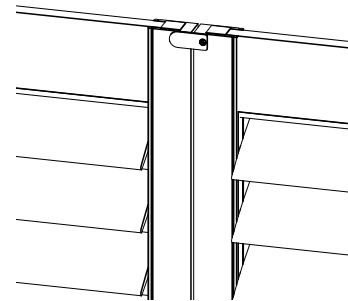

Rear View of Café Panel
Optional: Café Aligning Catch

- Tops of wood panels are finished
- Café shutter panels cover the lower portion of the window
- Frame can be ordered to stop at panel height or can be ordered to fully frame the window
- Pricing is based on width x café panel height
- Panels come standard with magnet on the base of each panel; aligning catch at the top panels is optional and must be requested at the time of order
- Panel configurations ordered with a T-post will come with T-post cut to frame height, not café panel height

ORDER ENTRY TIP: When ordering frames to stop at panel height: 3-sided, 3-sided sill top, or 4-sided with or without sill configurations must be entered as standard shutters. 2-sided, 3-sided inverted, and 3-sided inverted sill bottom can be entered as café with panel and frame height the same size.

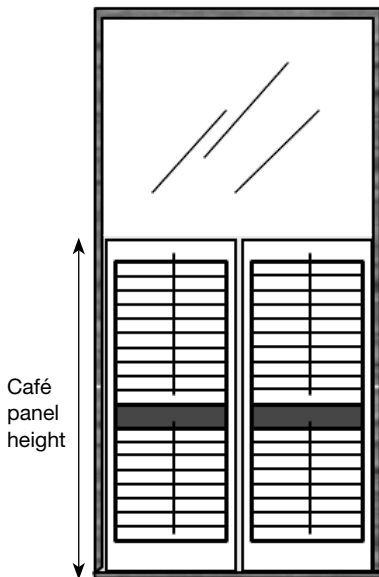

Café panel height

Café Shutter
Shown with full window-height frame option.

Includes the bottom frame or sill frame, if ordered

Café is available in a variety of frames, both inside and outside mount.

- Measure format depends on frame type selected
- For direct mount, use “window opening” size (WO) and no frame is furnished
NOTE: Panel will be 1/8" smaller than café panel height ordered for bottom swing clearance.
- For hang strip, use “window opening” size (WO) and hang strip will be the same height as café panel
NOTE: Panel will be 1/8" smaller than café panel height ordered for bottom swing clearance.
- For Z-frame, use “window opening” size (WO) and frame can be made at same height as café panel or be made at window height for “full-height frame”
NOTE: The café panel height ordered will include whatever frame configuration is ordered for the bottom. The café panel height at which the panels will stop.
- For L-frame and traditional deco frame, use “frame-to-frame” size (F-F) and frame can be made the same height as café panel or be made at window height for “full-height frame”
NOTE: The café panel height ordered will include whatever frame configuration is ordered for the bottom. The café panel height at which the panels will stop.

Specialty Styles

Double Hung Shutters

A specialty shutter style with one set of shutter panels over the top of another set of shutter panels in a continuous frame within a window. The panels are independent of each other, allowing each panel to operate separately.

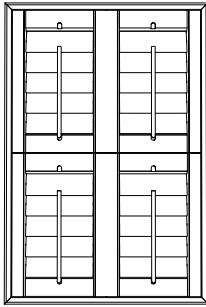

Double Hung

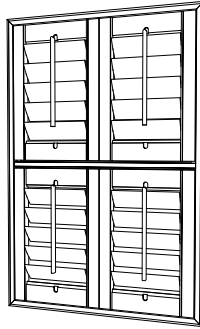

Double Hung with Horizontal T-Post

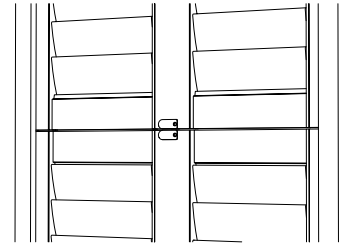

Rear View of Double Hung Panel with Aligning Catch

- Tops of wood panels are finished
- Maximum of up to four panel shutter configurations per set only
- Top and bottom panel sections must have identical panel configurations
- All frame configurations available
- Maximum height of bottom panel 84"
- Maximum height of top panel 60"
- Top rails in bottom set and bottomrails in top set will not exceed 3½" on 2½" and 3½" louvers
 - 4½" louvers may have rails larger than 3½"
- Divider rail not available
- Split tilt available as center only; cannot be specified
 - Split tilt available as either top or bottom panel sets or both top and bottom
- Available with Front Tilt (1-way and 2-way closure), Hide-A-Tilt™ (1-way and 2-way closure), and Astragal
- Aligning catch automatically included in LR, LLR, LRR, LTLR, LRTR, LLRR, LRTLRL, and LTLRTR configurations
- Horizontal T-post option available
 - L-bracket automatically included with all horizontal T-post orders (see image to right)
 - If horizontal T-post is ordered with panel configuration including a T-post, the horizontal T-post will be split and the vertical T-post will be one piece
 - Not available with sidelight frame or when order ships from Asia

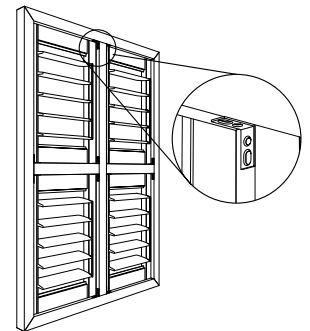

Specialty Styles

Double Hung Shutters: Minimum and Maximum Order Width (by panel configuration)

Number of Panels	Panel Configurations	Direct Mount, Hang Strip, and Tilt-Out Z-Frame		Z-Frame		L-Frame		Narrow Colonial L-Frame		3" Traditional Deco Frame		3½" Curved, Beaded, Craftsman, Deco Frame	
		WO Size		WO Size		F-F Size		F-F Size		F-F Size		F-F Size	
		Minimum (inches)	Maximum (inches)	Minimum (inches)	Maximum (inches)	Minimum (inches)	Maximum (inches)	Minimum (inches)	Maximum (inches)	Minimum (inches)	Maximum (inches)	Minimum (inches)	Maximum (inches)
1 Panel	L, R	9 ³ / ₁₆	36 ³ / ₁₆	11	38	11 ³ / ₁₆	38 ³ / ₁₆	10 ¹¹ / ₁₆	37 ¹¹ / ₁₆	13 ³ / ₁₆	40 ³ / ₁₆	14 ¹⁵ / ₁₆	41 ¹⁵ / ₁₆
2 Panels	LR	18 ¹ / ₁₆	72 ¹ / ₁₆	19 ⁷ / ₁₆	73 ⁷ / ₁₆	20 ¹ / ₁₆	74 ¹ / ₁₆	19 ⁹ / ₁₆	73 ⁹ / ₁₆	22 ¹¹ / ₁₆	76 ¹¹ / ₁₆	23 ¹³ / ₁₆	77 ¹³ / ₁₆
	LTR, LTL, RTR, RTL	19 ⁹ / ₁₆	73 ⁹ / ₁₆	21 ³ / ₁₆	75 ³ / ₁₆	21 ¹ / ₁₆	75 ¹ / ₁₆	20 ¹ / ₁₆	74 ¹ / ₁₆	24	78	25 ⁵ / ₁₆	79 ⁵ / ₁₆
	LL, RR	18 ¹ / ₁₆	52 ¹ / ₁₆	19 ⁷ / ₁₆	53 ⁷ / ₁₆	20 ¹ / ₁₆	54 ¹ / ₁₆	19 ⁹ / ₁₆	53 ¹⁵ / ₁₆	22 ¹¹ / ₁₆	56 ¹¹ / ₁₆	23 ¹³ / ₁₆	57 ¹³ / ₁₆
3 Panels	LLR, LRR	27 ¹ / ₄	78 ¹ / ₄	29 ¹ / ₁₆	80 ¹ / ₁₆	29 ¹ / ₄	80 ¹ / ₄	28 ³ / ₄	79 ³ / ₄	31 ⁷ / ₁₆	82 ⁷ / ₁₆	33	84
	LLTR, LTRR	28 ¹ / ₄	89 ¹ / ₄	30 ¹ / ₁₆	91 ¹ / ₁₆	30 ¹ / ₄	91 ¹ / ₄	29 ³ / ₄	90 ³ / ₄	32 ² / ₁₆	93 ² / ₁₆	34	95
	LTLR, LRTR	28 ¹ / ₄	109 ¹ / ₄	30 ¹ / ₁₆	111 ¹ / ₁₆	30 ¹ / ₄	111 ¹ / ₄	29 ³ / ₄	110 ³ / ₄	32 ² / ₁₆	113 ² / ₁₆	34	115
	LTLTR, LTRTR, LTLTL, RTRTR	29 ¹ / ₁₆	110 ¹ / ₁₆	31 ¹ / ₁₆	112 ¹ / ₁₆	31 ¹ / ₁₆	112 ² / ₁₆	31 ¹ / ₁₆	112 ¹ / ₁₆	34 ³ / ₁₆	115 ¹³ / ₁₆	35 ⁵ / ₁₆	116 ⁵ / ₁₆
4 Panels	LLRR	36 ⁵ / ₁₆	104 ⁵ / ₁₆	38 ³ / ₈	106 ³ / ₈	38 ⁵ / ₁₆	106 ⁵ / ₁₆	37 ¹³ / ₁₆	105 ¹³ / ₁₆	40 ¹⁵ / ₁₆	108 ¹⁵ / ₁₆	42 ¹ / ₁₆	110 ¹ / ₁₆
	LLTRR	37 ⁷ / ₁₆	105 ⁷ / ₁₆	38 ¹⁵ / ₁₆	106 ¹⁵ / ₁₆	39 ¹ / ₈	107 ¹ / ₈	38 ³ / ₈	106 ³ / ₈	41 ³ / ₄	109 ³ / ₄	42 ⁷ / ₁₆	110 ⁷ / ₁₆
	LRTLRL	37 ⁷ / ₁₆	145 ⁷ / ₁₆	38 ¹⁵ / ₁₆	146 ¹⁵ / ₁₆	39 ¹ / ₈	147 ¹ / ₈	38 ³ / ₈	146 ³ / ₈	41 ³ / ₄	149 ³ / ₄	42 ⁷ / ₁₆	150 ⁷ / ₁₆
	LTLRTR	38 ⁷ / ₁₆	146 ⁷ / ₁₆	40 ¹ / ₄	148 ¹ / ₄	40 ¹ / ₁₆	148 ⁷ / ₁₆	39 ¹⁵ / ₁₆	147 ¹⁵ / ₁₆	43 ¹ / ₁₆	151 ¹ / ₁₆	44 ³ / ₁₆	152 ¹³ / ₁₆
	LTRTLTR, LTLTRTR	39 ¹ / ₄	147 ¹ / ₄	41 ¹ / ₁₆	149 ¹ / ₁₆	41 ¹ / ₄	149 ¹ / ₄	41 ¹ / ₄	149 ¹ / ₄	44 ³ / ₈	152 ³ / ₈	45 ¹ / ₂	153 ¹ / ₂

Measuring Double Hung Split Location

Measure double hung split location exactly how you measure for divider rail and split tilt (see “Measuring Divider Rail or Split Tilt Location” section). Always start from the bottom point of measurement to center of the desired double hung split.

- Double hung split location will always be exact
- If ordering a horizontal T-post, ordered split location will be located at the center of the T-post

To measure frame-to-frame, measure from the bottom of the shutter frame up to the center of the desired double hung split location.

To measure window opening, measure from the sill or bottom of the window opening to the center of the desired double hung split location.

Specialty Styles

Double Hung Shutters: Minimum and Maximum Order Height (by frame type and louver size)

Measure Type	Frame Configuration	Frame Type	Minimum (inches)			Maximum (inches)
			Louver Size			Louver Size
			2½	3½	4½	2½, 3½, 4½
Window Opening	2-sided	Direct mount / hang strip	20 ⁷ / ₁₆	24 ⁷ / ₁₆	28 ⁷ / ₁₆	120 ⁷ / ₁₆
	3-sided inverted with sill cap bottom		20 ¹⁵ / ₁₆	24 ¹⁵ / ₁₆	28 ¹⁵ / ₁₆	120 ¹⁵ / ₁₆
	2-sided	Z-frame (except tilt-out)	20 ⁷ / ₁₆	24 ⁷ / ₁₆	28 ⁷ / ₁₆	120 ⁷ / ₁₆
	3-sided and 3-sided inverted		21 ⁷ / ₁₆	25 ⁷ / ₁₆	29 ⁷ / ₁₆	121 ⁷ / ₁₆
	3-sided sill top or bottom		20 ¹³ / ₁₆	24 ¹³ / ₁₆	28 ¹³ / ₁₆	120 ¹³ / ₁₆
	3-sided inverted with sill cap bottom		20 ¹⁵ / ₁₆	24 ¹⁵ / ₁₆	28 ¹⁵ / ₁₆	120 ¹⁵ / ₁₆
	4-sided		22 ¹ / ₄	26 ¹ / ₄	30 ¹ / ₄	122 ¹ / ₄
	4-sided with sill top or bottom		21 ³ / ₁₆	25 ³ / ₁₆	29 ³ / ₁₆	121 ³ / ₁₆
	4-sided with sill top and bottom		21 ³ / ₁₆	25 ³ / ₁₆	29 ³ / ₁₆	121 ³ / ₁₆
	4-sided with sill cap bottom		21 ⁷ / ₁₆	25 ⁷ / ₁₆	29 ⁷ / ₁₆	121 ⁷ / ₁₆
	4-sided with sill frame top and sill cap bottom	21 ⁵ / ₁₆	25 ⁵ / ₁₆	29 ⁵ / ₁₆	121 ⁵ / ₁₆	
	2-sided	Tilt-out Z-frame	20 ⁷ / ₁₆	24 ⁷ / ₁₆	28 ⁷ / ₁₆	120 ⁷ / ₁₆
	3-sided and 3-sided inverted		20 ⁷ / ₁₆	24 ⁷ / ₁₆	28 ⁷ / ₁₆	120 ⁷ / ₁₆
	3-sided sill top or bottom		20 ¹³ / ₁₆	24 ¹³ / ₁₆	28 ¹³ / ₁₆	120 ¹³ / ₁₆
	3-sided inverted with sill cap bottom		20 ¹⁵ / ₁₆	24 ¹⁵ / ₁₆	28 ¹⁵ / ₁₆	120 ¹⁵ / ₁₆
	4-sided		20 ⁷ / ₁₆	24 ⁷ / ₁₆	28 ⁷ / ₁₆	120 ⁷ / ₁₆
	4-sided with sill top or bottom		20 ¹³ / ₁₆	24 ¹³ / ₁₆	28 ¹³ / ₁₆	120 ¹³ / ₁₆
	4-sided with sill top and bottom		21 ³ / ₁₆	25 ³ / ₁₆	29 ³ / ₁₆	121 ³ / ₁₆
4-sided with sill cap bottom	20 ⁷ / ₁₆		24 ⁷ / ₁₆	28 ⁷ / ₁₆	120 ⁷ / ₁₆	
4-sided with sill frame top and sill cap bottom	20 ¹⁵ / ₁₆	24 ¹⁵ / ₁₆	28 ¹⁵ / ₁₆	120 ¹⁵ / ₁₆		
Frame-to-Frame	2-sided	L-frame (except narrow colonial)	20 ⁷ / ₁₆	24 ⁷ / ₁₆	28 ⁷ / ₁₆	120 ⁷ / ₁₆
	3-sided and 3-sided inverted		21 ⁷ / ₁₆	25 ⁷ / ₁₆	29 ⁷ / ₁₆	121 ⁷ / ₁₆
	3-sided sill top or bottom		20 ¹³ / ₁₆	24 ¹³ / ₁₆	28 ¹³ / ₁₆	120 ¹³ / ₁₆
	3-sided inverted with sill cap bottom		20 ¹⁵ / ₁₆	24 ¹⁵ / ₁₆	28 ¹⁵ / ₁₆	120 ¹⁵ / ₁₆
	4-sided		22 ⁷ / ₁₆	26 ⁷ / ₁₆	30 ⁷ / ₁₆	122 ⁷ / ₁₆
	4-sided with sill top or bottom		21 ¹³ / ₁₆	25 ¹³ / ₁₆	29 ¹³ / ₁₆	121 ¹³ / ₁₆
	4-sided with sill top and bottom		21 ³ / ₁₆	25 ³ / ₁₆	29 ³ / ₁₆	121 ³ / ₁₆
	4-sided with sill cap bottom		21 ¹⁵ / ₁₆	25 ¹⁵ / ₁₆	29 ¹⁵ / ₁₆	121 ¹⁵ / ₁₆
	4-sided with sill frame top and sill cap bottom	20 ¹⁵ / ₁₆	24 ¹⁵ / ₁₆	28 ¹⁵ / ₁₆	120 ¹⁵ / ₁₆	
	2-sided	Narrow colonial L-frame	20 ⁷ / ₁₆	24 ⁷ / ₁₆	28 ⁷ / ₁₆	120 ⁷ / ₁₆
	3-sided and 3-sided inverted		21 ³ / ₁₆	25 ³ / ₁₆	29 ³ / ₁₆	121 ³ / ₁₆
	3-sided sill top or bottom		20 ¹³ / ₁₆	24 ¹³ / ₁₆	28 ¹³ / ₁₆	120 ¹³ / ₁₆
	3-sided inverted with sill cap bottom		20 ¹⁵ / ₁₆	24 ¹⁵ / ₁₆	28 ¹⁵ / ₁₆	120 ¹⁵ / ₁₆
	4-sided		21 ¹⁵ / ₁₆	25 ¹⁵ / ₁₆	29 ¹⁵ / ₁₆	121 ¹⁵ / ₁₆
	4-sided with sill top or bottom		21 ⁹ / ₁₆	25 ⁹ / ₁₆	29 ⁹ / ₁₆	121 ⁹ / ₁₆
	4-sided with sill top and bottom		21 ³ / ₁₆	25 ³ / ₁₆	29 ³ / ₁₆	121 ³ / ₁₆
	4-sided with sill cap bottom		21 ¹¹ / ₁₆	25 ¹¹ / ₁₆	29 ¹¹ / ₁₆	121 ¹¹ / ₁₆
	4-sided with sill frame top and sill cap bottom	20 ¹⁵ / ₁₆	24 ¹⁵ / ₁₆	28 ¹⁵ / ₁₆	120 ¹⁵ / ₁₆	
	2-sided	3½" deco frame (curved, beaded, and craftsman)	20 ⁷ / ₁₆	24 ⁷ / ₁₆	28 ⁷ / ₁₆	120 ⁷ / ₁₆
	3-sided and 3-sided inverted		23 ⁹ / ₁₆	27 ⁹ / ₁₆	31 ⁹ / ₁₆	123 ⁹ / ₁₆
	3-sided sill top or bottom		20 ¹³ / ₁₆	24 ¹³ / ₁₆	28 ¹³ / ₁₆	120 ¹³ / ₁₆
	3-sided inverted with sill cap bottom		20 ¹⁵ / ₁₆	24 ¹⁵ / ₁₆	28 ¹⁵ / ₁₆	120 ¹⁵ / ₁₆
	4-sided		26 ³ / ₁₆	31 ³ / ₁₆	35 ³ / ₁₆	126 ³ / ₁₆
	4-sided with sill top or bottom		23 ¹¹ / ₁₆	27 ¹¹ / ₁₆	31 ¹¹ / ₁₆	123 ¹¹ / ₁₆
	4-sided with sill top and bottom		21 ³ / ₁₆	25 ³ / ₁₆	29 ³ / ₁₆	121 ³ / ₁₆
	4-sided with sill cap bottom		23 ¹³ / ₁₆	27 ¹³ / ₁₆	31 ¹³ / ₁₆	123 ¹³ / ₁₆
	4-sided with sill frame top and sill cap bottom	20 ¹⁵ / ₁₆	24 ¹⁵ / ₁₆	28 ¹⁵ / ₁₆	120 ¹⁵ / ₁₆	
	2-sided	3" deco frame (traditional)	20 ⁷ / ₁₆	24 ⁷ / ₁₆	28 ⁷ / ₁₆	120 ⁷ / ₁₆
	3-sided and 3-sided inverted		22 ¹ / ₄	26 ¹ / ₄	30 ¹ / ₄	122 ¹ / ₄
	3-sided sill top or bottom		20 ¹³ / ₁₆	24 ¹³ / ₁₆	28 ¹³ / ₁₆	120 ¹³ / ₁₆
3-sided inverted with sill cap bottom	20 ¹⁵ / ₁₆		24 ¹⁵ / ₁₆	28 ¹⁵ / ₁₆	120 ¹⁵ / ₁₆	
4-sided	23 ¹ / ₈		27 ¹ / ₈	31 ¹ / ₈	123 ¹ / ₈	
4-sided with sill top or bottom	22 ¹ / ₁₆		26 ¹ / ₁₆	30 ¹ / ₁₆	122 ¹ / ₁₆	
4-sided with sill top and bottom	21 ³ / ₁₆		25 ³ / ₁₆	29 ³ / ₁₆	121 ³ / ₁₆	
4-sided with sill cap bottom	23 ¹ / ₄		27 ¹ / ₄	31 ¹ / ₄	123 ¹ / ₄	
4-sided with sill frame top and sill cap bottom	20 ¹⁵ / ₁₆	24 ¹⁵ / ₁₆	28 ¹⁵ / ₁₆	120 ¹⁵ / ₁₆		

NOTE: Maximum height of top panel is 60". Maximum height of bottom panel is 84".

Specialty Styles

Sunburst Arch without Frame

Specialty Shape without Frame: Panel Only

- Sunburst pattern—no horizontal louvers
- Beveled louvers for maximum light control
- Louver sizes will vary based on height and width of arch
- Louver rotation will vary based on louver size and louvers will not open to a full 90 degrees
- The arch has no tilt bar; the louvers open individually and are spring loaded at the bottom pin
- All wood colors available; wood arches can be matched to composite colors
- Buildouts not available
- Panel is 1" thick and may not match projection of other outside mount standard shutters
- Order arch as frame-to-frame finished size (factory takes no deductions)

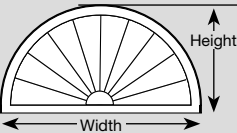
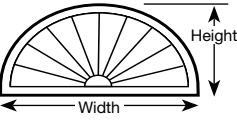
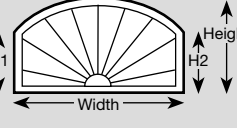
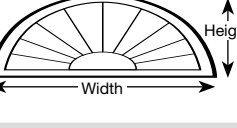
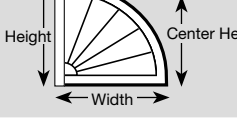
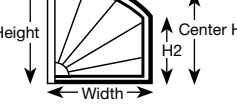

Allow sufficient wall space to mount. Panel-only arches are:

Wood Frameless Arch Base Width (inches)	Top Rail Size (inches)	Bottomrail Size (inches)
20 to less than 24	2	1
24 to less than 45	3	2
45 to less than 80	3	3
80 to 108	4	4

Specialty Shape without Frame: Minimum and Maximum Sizes				
Frameless Full and ¼ Sunburst Arches—Panel Only	Width		Height	
	Minimum (inches)	Maximum (inches)	Minimum (inches)	Maximum (inches)
 <p>Perfect Sunburst Arch (order as eyebrow) Height = 50% of width No template required</p>	20	108	10	54
 <p>Eyebrow Sunburst Arch Height minimum = no less than 33% of width Height maximum = no greater than 66% of width Template required if height exceeds 54% of width</p>	20	108	7	54
 <p>Elongated Sunburst Arch Height minimum = no less than 33% of width Height maximum = no greater than 66% of width Template required if ordered height minus ordered leg height exceeds 54% of width</p>	20	108	10	71¼
 <p>Elliptical Sunburst Arch Height minimum = no less than 33% of width Height maximum = no greater than 66% of width Template always required</p>	20	108	10	54
 <p>¼ Eyebrow Sunburst Arch Leg height minimum = 33% of width Leg height maximum = 108% of width</p>	15	54	7	54
 <p>¼ Elongated Sunburst Arch Leg height minimum = 33% of width Leg height maximum = 132% of width</p>	15	54	10	71¼

Specialty Styles

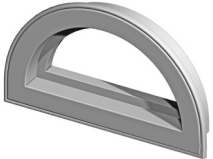
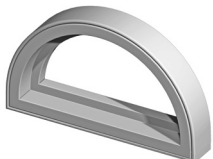
Sunburst Arch with Frame

			
Frame Options	Z-Frame*	L-Frame**	Deco Frame
Mount	Inside mount only	Outside mount only	Outside mount only
Order Size	Window opening	Frame-to-frame	Frame-to-frame
Projection	3/8"	2", 2 1/2", 3"	1 1/16", 1 3/16"

*Framed arches not available with tilt-out Z-frame.

**Narrow colonial L-frame will have 15/16" projection.

NOTE: All frame types are available with sill bottom.

Buildouts are available on L-frame and deco frame arches (not available with sill bottom).

Sill cap not available.

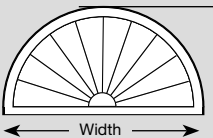
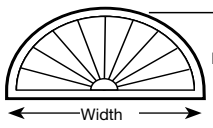
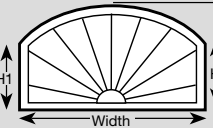
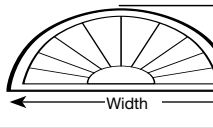
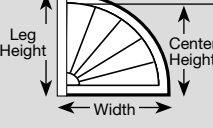
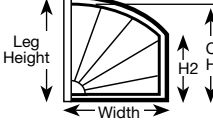
Specialty Shape without Frame: Minimum and Maximum Sizes					
		Width		Height	
		Minimum (inches)	Maximum (inches)	Minimum (inches)	Maximum (inches)
Framed Full and 1/4 Sunburst Arches					
	<p>Perfect Sunburst Arch (order as eyebrow) Height = 50% of width No template required</p>	<p>Z-frame L-frame Narrow colonial L-frame 3" deco frame 3 1/2" deco frame</p>	<p>21 13/16 22 1/8 21 24 3/4 25 5/8</p>	<p>109 13/16 110 1/8 105 5/8 112 3/4 113 3/8</p>	<p>11 13/16 12 1/8 11 14 3/4 15 5/8</p>
	<p>Eyebrow Sunburst Height minimum = no less than 33% of width Height maximum = no greater than 66% of width Template required if height exceeds 54% of width</p>	<p>Z-frame L-frame Narrow colonial L-frame 3" deco frame 3 1/2" deco frame</p>	<p>21 13/16 22 1/8 21 24 3/4 25 5/8</p>	<p>109 13/16 110 1/8 105 5/8 112 3/4 113 3/8</p>	<p>8 1/16 9 1/8 8 5/8 11 1/4 12 3/8</p>
	<p>Elongated Sunburst Height minimum = no less than 33% of width Height maximum = no greater than 66% of width Template required if ordered height minus ordered leg height exceeds 54% of width</p>	<p>Z-frame L-frame Narrow colonial L-frame 3" deco frame 3 1/2" deco frame</p>	<p>21 13/16 22 1/8 21 24 3/4 25 5/8</p>	<p>109 13/16 110 1/8 105 5/8 112 3/4 113 3/8</p>	<p>11 13/16 12 1/8 11 14 3/4 15 5/8</p>
	<p>Elliptical Sunburst Arch Height minimum = no less than 33% of width Height maximum = no greater than 66% of width Template always required</p>	<p>Z-frame L-frame Narrow colonial L-frame 3" deco frame 3 1/2" deco frame</p>	<p>21 13/16 22 1/8 21 24 3/4 25 5/8</p>	<p>109 13/16 110 1/8 105 5/8 112 3/4 113 3/8</p>	<p>8 1/16 9 1/8 8 5/8 11 1/4 12 3/8</p>
	<p>1/4 Eyebrow Sunburst Arch Leg height minimum = 33% of width Leg height maximum = 108% of width</p>	<p>Z-frame L-frame 3" deco frame 3 1/2" deco frame</p>	<p>16 13/16 17 1/8 19 3/4 20 5/8</p>	<p>55 13/16 56 1/8 58 3/4 59 3/8</p>	<p>11 13/16 12 1/8 14 3/4 15 5/8</p>
	<p>1/4 Elongated Sunburst Arch Leg height minimum = 33% of width Leg height maximum = 132% of width</p>	<p>Z-frame L-frame 3" deco frame 3 1/2" deco frame</p>	<p>16 13/16 17 1/8 19 3/4 20 5/8</p>	<p>55 13/16 56 1/8 58 3/4 59 3/8</p>	<p>11 13/16 12 1/8 14 3/4 15 5/8</p>

NOTE: The following frame types are not available as 1/4 arches:

- Narrow colonial L-frame
- Bullnose Z-frame
- Craftsman deco and Z-frame
- 2 1/2" and 3" extended standard L-frame
- 2 1/2" and 3" extended narrow colonial L-frame

Specialty Styles

Framed Arch Installation Option

Arches arrive with the louvers not installed and packed separately. Louvers are numbered on bottom edge from right to left on the bottom as you look at the interior (room) side.

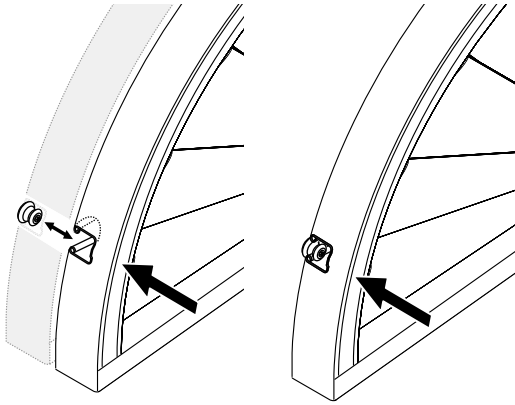

Framed Arch—Installing Panel to Frame

Button catch (imbedded) is standard. Panels are attached to frame via button catch. The frame itself installs as a standard L-, Z-, or deco frame.

Frameless Arch Installation Option

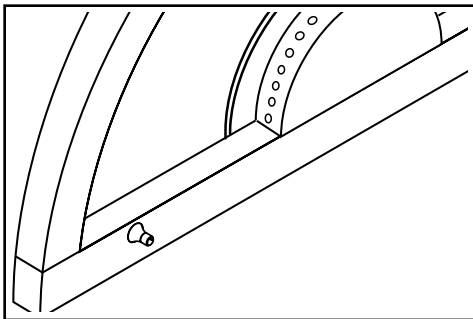

Bulldog Catch

Bulldog catch works best with window openings that have a square edge. Allows arch panel to be removed for cleaning. Available in White.

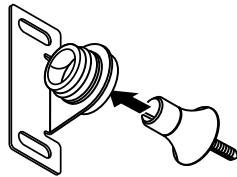

Suggested quantity usage:

Less than 36" — 3

36" to 72" — 5

72" to 108" — 7

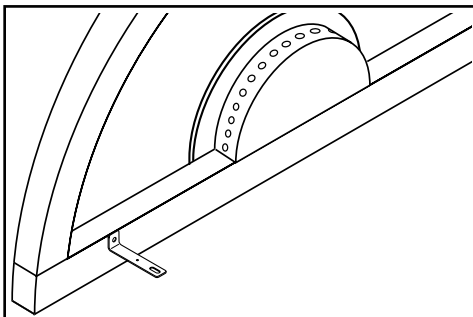

L-Bracket

L-bracket works best with windows that have a bullnosed edge. Long-throw on the L-bracket allows you to reach past the curved window edge to a flat surface. Available in zinc color.

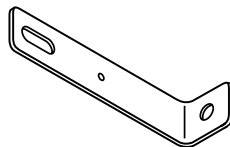

Suggested quantity usage:

Less than 36" — 5

36" to 72" — 7

72" to 108" — 9

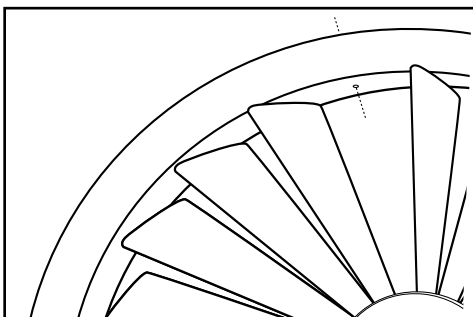

Trim Head Screw

If using trim head screws to mount, pilot a hole diagonally from underside of curved frame and exit through rear of frame. Place screw hole near louver pin to help hide hole from view.

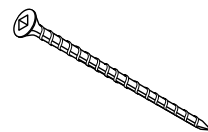

Specialty Styles

Arch and Angle Top Panel Shutters

See chart below for available options.

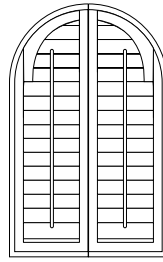

Arch Top Panel

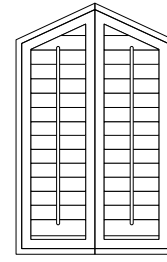

Angle Top Panel

	Arch Top Panel	Arch Top Panel with 5+ Panels	¼ Arch Top, ½ Angle, Angle
Manufacturing Location	Reynosa	Asia	Asia
Louver Sizes	2½", 3½", 4½"	2½", 3½", 4½"	2½", 3½", 4½"
Colors	All wood colors Can match composite colors Custom/competitor color match	All wood colors Can match composite colors Custom/competitor color match	All wood colors Can match composite colors Custom/competitor color match
Astragal	Yes—standard or reversed	Yes—standard or reversed	Yes—standard or reversed
Hide-A-Tilt™	Yes	Yes	Yes
Divider Rail	One available Center or specified Will have +/- 2" tolerance	One available Center or specified Will have +/- 2" tolerance	One available Center or specified Will have +/- 2" tolerance
Split Tilt	One available Center or specified Will have +/- 2" tolerance	One available Center or specified Will have +/- 2" tolerance	One available Center or specified Will have +/- 2" tolerance
Panel Configurations	All panel configurations up to and including 4 panels	All panel configurations with 5 or more panels	All panel configurations
Frame Configurations	3-sided, 4-sided, 4-sided with sill bottom, 4-sided with sill cap	3-sided, 4-sided, 4-sided with sill bottom	3-sided, 4-sided, 4-sided with sill bottom
Buildouts	Yes—outside mount frames, 4-sided only	Yes—outside mount frames, 4-sided only	Yes—outside mount frames, 4-sided only
Frames Not Available	Tilt Z	Tilt Z Bullnose Z-frame Craftsman Z-frame 2½" L-frame 3" L-frame Narrow colonial L 3½" craftsman deco	Tilt Z Bullnose Z-frame Craftsman Z-frame 2½" L-frame 3" L-frame Narrow colonial L 3½" craftsman deco
Hide-A-Tilt Colors	White Steel Grey	Steel Grey	Steel Grey
Options Not Available on Specialties	Double hung 2-way closure Split tilt/divider rail combination		

Arch Operation

- Louver tilt is restricted up to 90° (degrees) due to the curvature (or slope) at the top of the panel; a divider rail or split tilt can be used to separate the upper arch portion from the lower rectangular portion; this will allow for full louver rotation of the louvers below the divider rail or split tilt
- Arch louvers tilt/close in the upwards position only
- When ordering a wood arch and the tilt bar does not reach the top louvers, a tilt bar will be added to the back of the shutter to allow all louvers to close together at the same time

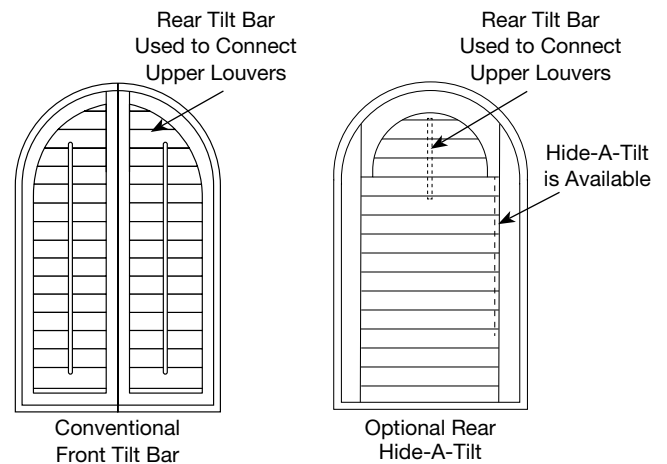

Specialty Styles

Arch and Angle Top Panel Shutters Height Limitations

See size considerations for width minimums and maximums.

Ordered Height Limitations for Arch and Angle Top Shutters					
	Frame Configuration	Frame Type	Minimum (inches)		Maximum (inches)
			Louver Size		Louver Size
			2½", 3½"	4½"	2½", 3½", 4½"
Window Opening	2-sided	Hang strip/direct mount	15¼	20¼	120¼
	3-sided	Z-frames	16⅞	21⅞	121⅞
	4-sided with sill bottom	Z-frames	16⅞	21⅞	121⅞
	4-sided	Z-frames	17⅞	22⅞	122⅞
Frame-to-Frame	3-sided	L-frames	16¼	21¼	121¼
	4-sided with sill bottom	L-frames	16¾	21¾	121¾
	4-sided	L-frames	17¼	22¼	122¼
	3-sided	Narrow colonial L-frame	16	21	121
	4-sided with sill bottom	Narrow colonial L-frame	16½	21½	121½
	4-sided	Narrow colonial L-frame	16¾	21¾	121¾
	3-sided	Deco frames (curved/beaded/craftsman)	18⅞	23⅞	123⅞
	4-sided with sill bottom	Deco frames (curved/beaded/craftsman)	18½	23½	123½
	4-sided	Deco frames (curved/beaded/craftsman)	21	26	126
	3-sided	Traditional deco frame	17⅞	22⅞	122⅞
	4-sided with sill bottom	Traditional deco frame	17⅞	22⅞	122⅞
	4-sided	Traditional deco frame	19¾	24¾	124¾

NOTES:

1. Minimum leg height is 13" on arch top panels and angle tops.
2. All frames except tilt Z available.
3. Divider rail requirements are the same as standard shutters. One divider rail available on arches/angles.
4. Template required when the ordered height minus the leg height is over 54% of the width.

Measuring Leg Height and Divider Rail Height for Window Opening

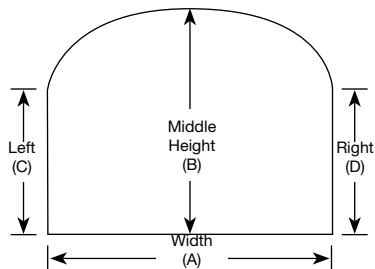

Frames requiring WO measurement:
Z-frame, hang strip, and direct mount

Measuring Leg Height:

Measure from bottom of window up to arch "break point."

- Minimum leg height is 13"

Measuring Divider and Split Tilt Rail Height:

Measure from bottom of window up to center of divider rail/split tilt.

Measuring Leg Height and Divider Rail Height for Frame-to-Frame Measurement

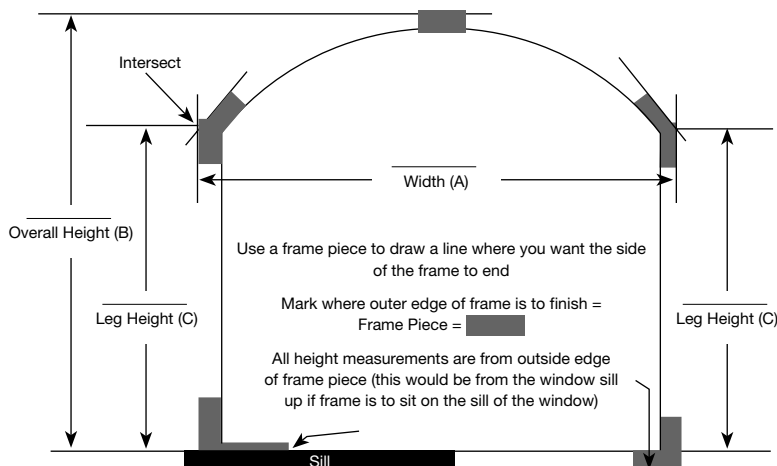

Frames Requiring F-F Measurement:

L-frames and traditional deco frames

Measuring Leg Height:

Measure from bottom edge of frame up to arch "intersect" of the window (C).

- Minimum leg height is 13"

Measuring Divider and Split Tilt Rail Height:

Measure from bottom of frame up to center of each divider rail/split tilt.

Specialty Styles

How To Make a Template

Template Requirements

Templates are only **required** for the following instances:

- Sunburst arches: if ordered height exceeds 54% of ordered width
- Arch top panels: if ordered height minus leg height is over 54% of ordered width
- Any arch with an elliptical arch shaped top

Templates are recommended for the following instances:

- Inside mount arches (direct mount, hang strip, frameless)

ALL OTHER ARCHES DO NOT NEED TEMPLATES.

Template Material

Acceptable material—Kraft paper, butcher paper, and light-weight poster paper that can be rolled without creasing.

Nonacceptable material—Newspaper, wrapping paper, tissue paper, fabrics, wood, cardboard, and wax paper.

If material used to make template tears, stretches, will not lay flat, or cannot be rolled, Springs Window Fashions will refuse to use the template and require a new one.

If more than one piece of paper must be used, a strong packing tape must hold pieces together. Painter's tape or scotch tape will not be accepted; this allows the paper to move and measurements to become inaccurate.

Creating the Template

1. Using painter's tape, tape paper over window opening, allowing adequate overlap over window to include any framing needed.
 - If window opening frame is being ordered, draw an exact outline of the window opening; manufacturing will make proper deductions for fit; be careful not to press in or crease the paper of the template while tracing.
 - If frame-to-frame arch or frameless arch is being ordered, the template should be made to the exact size needed; manufacturing will not take any deductions or make any additions to the size submitted.
2. Tracing arch should only be done with a pencil or pen that is no thicker than $\frac{1}{16}$ " thick to ensure correct arch size is ordered.
3. Remove the paper from the window and cut out the arch.
4. Fold template in half to verify template is symmetrical (mirror image). You may need to adjust size in field before shipping to Springs Window Fashions.
5. Once template is cut out, adjustments have been made, and template is symmetrical, place template back in window to ensure proper fit.
6. Mark template with the following:
 - Room side
 - SWF order number
 - Company name and account number
 - PO number
7. Attach a copy of the purchase order to the template.
8. Roll (DO NOT FOLD!) template and place in a shipping tube.
9. Mail to:
Springs Window Fashions, LLC
Attn: Shutter Department
8467 Route 405 South
P.O. Box 500
Montgomery, PA 17752

NOTE: Use only tape that will not pull off paint or wallpaper.

Comment on purchase order if a template is being sent; otherwise order may begin to be processed without.

Specialty Styles

French Door Options

- 2½", 3½", and 4½" louvers
- Available with Front Tilt (1-way and 2-way closure), Hide-A-Tilt™ (1-way and 2-way closure), Split Tilt
- All wood colors available; wood French doors can be matched to composite colors
- Single panels hinged on the same side as the door
- L-frames include standard L, extended standard L, narrow colonial L, and extended narrow colonial L
- Sidelight not available
- Order frame-to-frame
- Outside mount only
- Divider rails are not available
- Buildouts can be requested at time of order, extended L-frames provided as necessary
- Button catches plus magnets are standard to provide for a secure closure
- Narrow colonial L-frame is made with magnet catch closure only
- Split tilt will have +/- 2" tolerance from requested location

Projection Based on Louver Size (inches)	Standard L, Narrow Colonial L-Frame
2½	2" L-frame
3½	2½" L-frame
4½	3" L-frame

Manufacturing will automatically use a larger standard L-/narrow colonial L-frame projection for your order according to the louver size. An additional ½" or 1½" can also be requested if needed for louver clearance on larger trims. Factory will also make all adjustments to back plate elevation based on trim projection and extra buildout requested.

NOTE: All French door shutters for cut-out and no cut-out should be ordered at the same time to ensure rail size and louver counts will match.

French Door Sizes: Minimum and Maximum

	Minimum (inches)	Maximum (inches)
Width	16¾	38¾
Height	37¾	90¾

French Door Shutters: Placement of L-Frame

L-frame always sits outside of the trim, never on the trim. If no raised trim, place the L-frame far enough beyond the glass to rest totally flat on the door and to avoid risk of breaking the glass when driving the mounting screws in place. Use caution when placing screws, as the glass often extends under the trim and could easily crack.

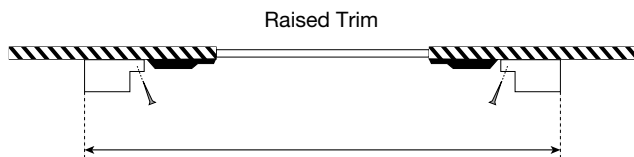

Always use frame-to-frame measure format for French doors.

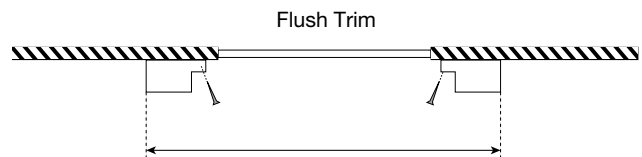

Always use frame-to-frame measure format for French doors.

French Door Shutters: Recessed Back Plate

A recessed back plate is required when there is insufficient space between the base of the door hardware and the glass trim to place L-frame flat on the door surface.

NO	YES
<p>Recessed back plate is not needed</p> <p>If measurement between the base of the hardware and the window trim is greater than 1½" when using a standard L-frame or 1" if using the narrow colonial L-frame (L-frame <u>does</u> fit between hardware and trim), back plate does not need to be recessed.</p>	<p>Recessed back plate is needed</p> <p>If measurement between the base of the hardware and the window trim is less than 1½" when using a standard L-frame or 1" if using the narrow colonial L-frame (L-frame <u>does not</u> fit between hardware and trim), back plate does need to be recessed.</p>
<p>If recessed back plate is required, the edge of back plate will align with inside edge of L-frame. Installer does not specify amount of recess.</p>	

Caution:

1. When measuring (F-F) width and height, be sure that L-frame can rest flat on the door surface and not be obstructed by the glass trim.
2. If "yes" is selected, the edge of the recessed back plate will be built to align with the inside edge of the L-frame.

Specialty Styles

French Door Options: Cut-Out

L-Frame
No Cut-Out

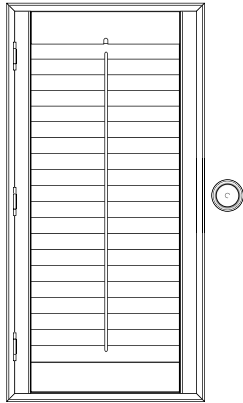

Rectangular Cut-Out
(surcharge applies)

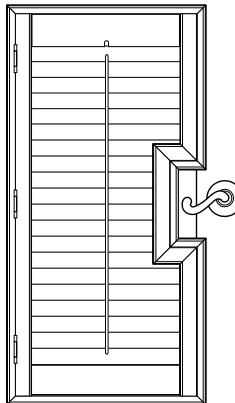

Curved Cut-Out
(surcharge applies)

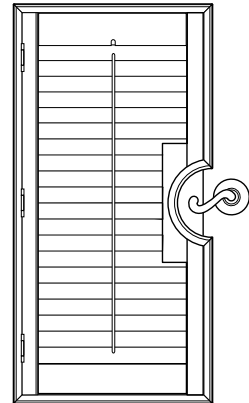

This should only be ordered when installed next to a French door with cut-out; otherwise order it as a standard shutter.

NOTE: If ordered as standard shutter, French door button catch can be added at time of order.

Order Rectangular Cut-Out when:

1. Choose if the base of the door hardware is rectangular.
2. Must specify width and height of the cut-out. There are NO set standard sizes to conform to. There are NO templates to use.
3. Be sure to make proper allowances for the door handle to pivot easily when determining your cut-out size.

Order a Curved Cut-Out when:

1. Choose a curved cut-out if the base of the door handle (or knob) is round.
2. Five (5) standard cut-out sizes are available: three (3) half-circles and two (2) half-ovals.
3. Other custom sizes of curved cut-outs are NOT available.
4. Be sure to make proper allowances for the door handle to pivot easily when determining your cut-out size.

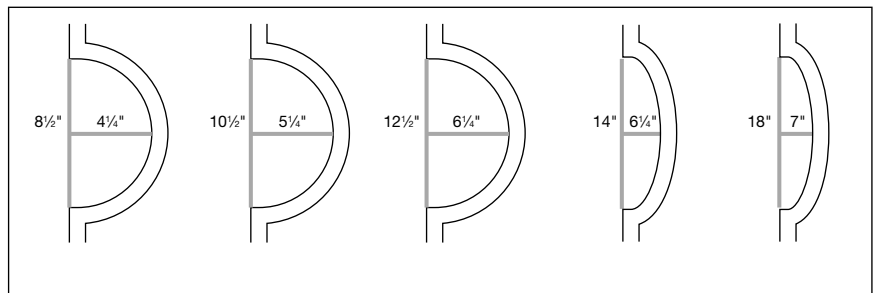

This image is taken from the backside of the French door order form.

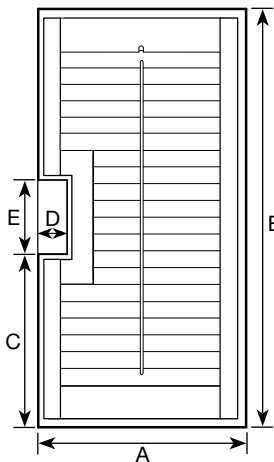

Rectangular Cut-Out

- A = Shutter width—frame-to-frame
- B = Shutter height—frame-to-frame
- C = Bottom of shutter frame to bottom of cut-out
- D = Width of cut-out
- E = Height of cut-out

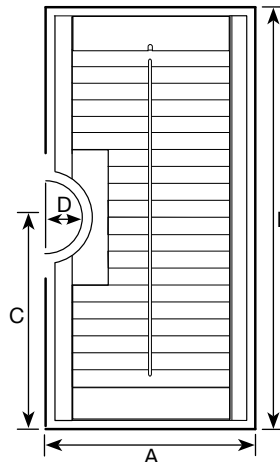

Curved Cut-Out

- A = Shutter width—frame-to-frame
- B = Shutter height—frame-to-frame
- C = Bottom of shutter frame to center of cut-out
- D = Width of cut-out

NOTE: Laminated template is available to help size curved cut-out (contact customer service to request).

Specialty Styles

Bypass Shutters

- Ideal solution for large windows and patio doors
- System consists of a double-top track and optional floor guides (no bottom track)
- All wood color options available
- Available in all louver sizes
- Available with Front Tilt (1-way and 2-way closure), Hide-A-Tilt™ (1-way and 2-way closure), and Split Tilt
- See the minimum and maximum order sizes charts (factory to determine panel size based on width ordered and configuration)
- Divider rail required over 84" ordered height
- Tracks wider than 144" will be spliced
- Header and valance could be spliced over 96"
- 1/2" buildout is available
- Divider rail with split tilt not available on the same shutter
- Mounting options:
 - Outside mount—with or without box-out (box-out recommended)
 - Exact frame-to-frame with box-out
 - Inside mount—minimum window depth 5 3/8"
- All mounting options include:
 - Track and header board: Unit includes two tracks installed to header; header is 5 1/2" deep and 3/4" thick
 - Valances: Two top treatment styles available: 5" double beaded standard valance and 4 1/2" decorative valance (optional)
 - Outside mount is available with stack back or custom header, see "Bypass Track System Stack Back Option" and "Custom Header" sections

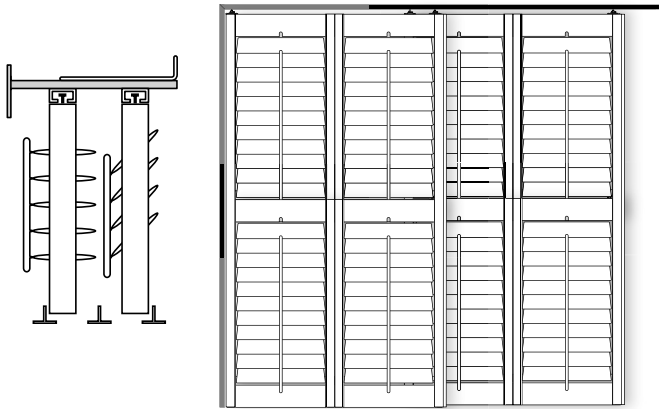

NOTE: Louvers must be closed in order for panels to pass each other.

Bypass Valance Options

4 1/2" Decorative Valance



5" Standard Valance



Valance Keystones

- Decorative keystones are automatically provided on wood valances that require splicing
- Keystones are centered/equally spaced unless special splice location is requested at time of order
- Optional keystones can be ordered with single piece valances under 96"; for surcharge, see price charts
- Maximum number of keystones per valance is three
- Keystones are stained or painted to match shutter color ordered
- Measuring instructions:
 - For inside/outside/exact ordering—indicate keystone measurement from left of window opening to center of keystone; manufacturing will calculate valance and keystone location to ensure correct location when installed in window.
 - For special valance width ordering—provide exact valance backside measurement needed; measure using inside measurement from inside corner of miter to center of keystone; keystone locations will be exact.

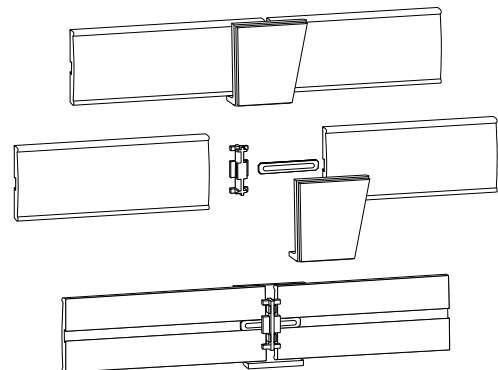

Specialty Styles

Bypass Shutters: Mounting Options

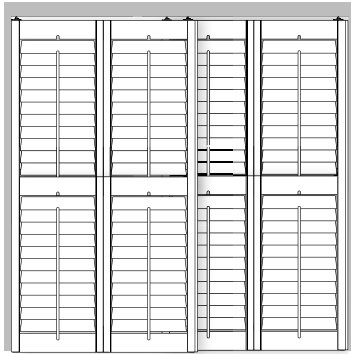

OUTSIDE MOUNT – WITH FACTORY ADDITIONS

Width Measure (with box-out): If no window trim: measure window opening size. If window trim: measure outside edge of trim to outside edge of trim and record as window opening size. **Regardless of ordered size, factory will add 3¼" to your overall ordered width.**

NOTE: When measuring, add more for bullnose drywall so that the frames mount completely on flat surface.

Width Measure (without box-out): If no window trim: measure window opening size. If window trim: measure outside edge of trim to outside edge of trim and record as window opening size. **Regardless of ordered size, factory will add 1¼" to your overall ordered width.**

NOTE: When measuring, add more to extend beyond window edge for more privacy.

Height Measure (with or without box-out): If no window trim: measure from floor surface to top of the window opening. If window trim: measure to top of window trim. **Regardless of ordered size, factory will add 2⅝" to your overall ordered height.**

Other Measuring Considerations: ½" buildout is available.

Valance Information: Valance returns are included and wrap around the outside of the box-out, if ordered. Returns are mitered (special valance width and return width available).

Box-Out Information: Optional side frames are 5½" deep and ¾" thick.

Stack Back Information: Optional to allow shutter panels to clear the window opening; factory will calculate based on ordered size. Custom/special header board size is also available if full stack back cannot be achieved.

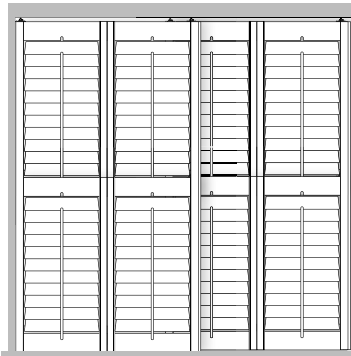

OUTSIDE MOUNT – EXACT FRAME-TO-FRAME

Width and Height Measure: Factory will not add or deduct from ordered size—measure width and height as finished frame-to-frame size including the box-out. Only available with box-out.

Other Measuring Considerations: ½" buildout is available.

Valance Information: Valance returns are included and wrap around the outside of the box. Returns are mitered (special valance width and return width available).

Box-Out Information: Required box-out side frames are 5½" deep and ¾" thick.

Stack Back Information: Stack back is not available. Custom/special header board size is available.

INSIDE MOUNT – WITH FACTORY DEDUCTIONS

Width Measure: Order window opening width and factory will make a ½" deduction off the track for proper fit.

Height Measure: Order window opening height and factory will make a ½" deduction. The carriers are adjustable.

Other Measuring Information: Minimum window depth required for 5⅜". No buildouts available.

Valance Information: Special valance width available. Valance returns and special return width available.

Box-Out Information: Not available.

Stack Back Information: Stack back and custom/special header board size are not available.

Specialty Styles

Bypass Track System Configuration Options (only configurations available)

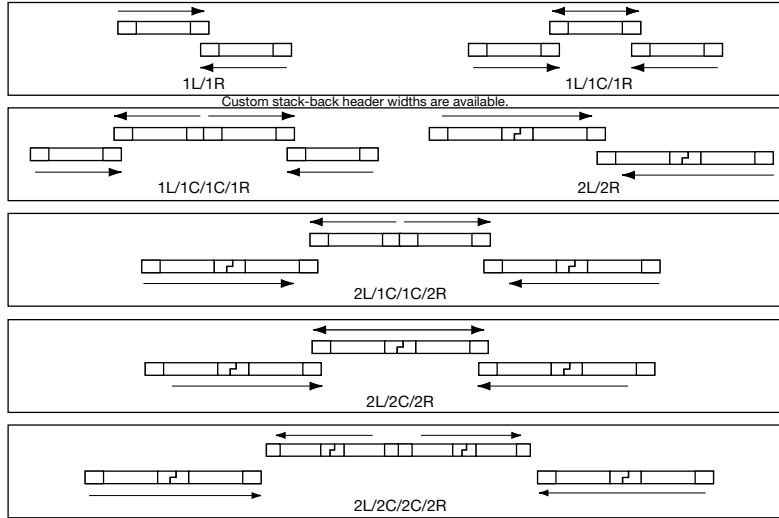

Bypass Shutters: Minimum and Maximum Width (order size by panel configuration)

Panel Configuration	Example of Shutter Unit Configurations Using Various Panel Combinations	Outside Mount with Additions		Inside Mount		Outside Mount – Exact	
		Order WO Size		Order WO Size		Exact Frame-to-Frame	
		Minimum Width (inches)	Maximum Width (inches)	Minimum Width (inches)	Maximum Width (inches)	Minimum Width (inches)	Maximum Width (inches)
1L/1R		18	70	20	71	19¼	73¼
1L/1C/1R*		27½	104	28½	106½	27¾	108¾
1L/1C/1C/1R		37	141	38	142	36¾	144¾
2L/2R		37¾	141¾	38¾	142¾	36	145
2L/1C/1C/2R*		56	212	58¾	213	54¾	216¾
2L/2C/2R*		57¾	213¾	58¾	213	54¾	216¾
2L/2C/2C/2R		76½	284½	77½	285½	71¼	287¼

*Window opening is 33% with these panel configurations. Stack back or custom header recommended.

NOTES:

- Same minimum/maximum sizes apply if ordered with stack back options and with or without box-out.
- Combinations with a 2C, 2L, or 2R will be rabbeted together and move as one unit.

Setting Bracket Height

(for outside mount without side frames)

For Wall Mount Bypass Shutter System

Top of Angle Bracket to Floor:

Top of bracket is 3⅞" above ordered height. This includes ½" clearance off the floor.

NOTE: With optional box-out, side frames determine the mounting height. Bottom edge of side frame is meant to touch the floor surface.

Wood Bypass Height Minimum and Maximum		
Options	Minimum (inches)	Maximum (inches)
Outside Mount	15¾	120¾
Inside Mount	17¼	122¼
Exact	15¾	122¼

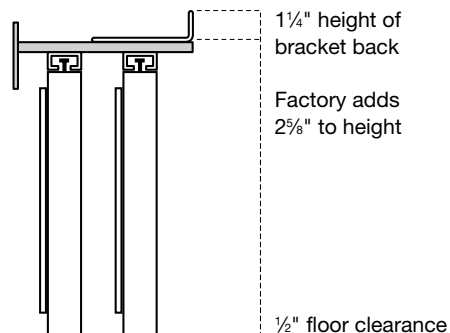

Specialty Styles

Bypass Track System Stack Back Option

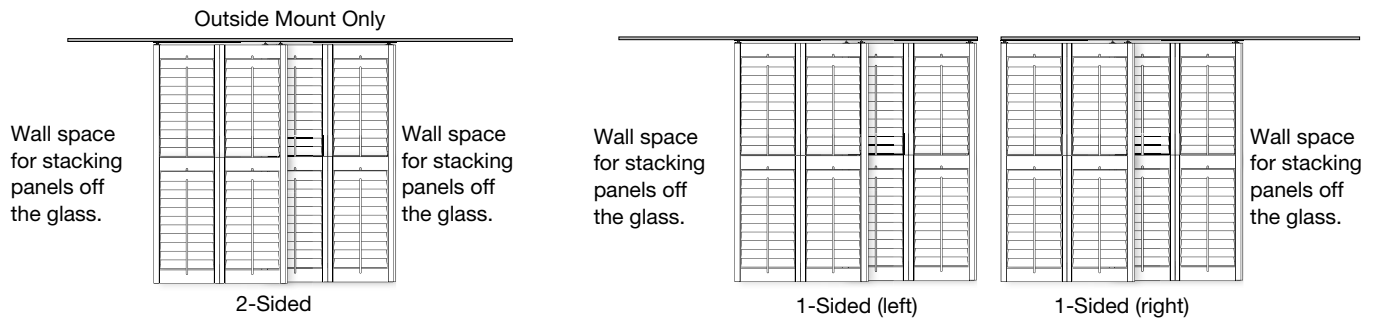

The stack back option allows for the shutter panels to clear the window opening, creating an unobstructed view. **Panels made to cover window. Header/track made larger so panels stack off glass.**

Measure only the window opening area for outside mount with stack back. Factory will calculate the correct stack back needed for full stack back. Custom header also available.

System consists of a double-top track and floor guides.

Calculating Approximate Stack Back: Factory will add additional width to ordered size for stack back. Amounts vary, depending on the number of panels. See chart below for total (approximate) amount that will be added to the window opening size. This determines the approximate overall unit width.

% of Window Opening Size Added for Various Numbers of Panels				
2	3	4	6	8
50%	66%	50%	66%	50%

Custom Header

If wall space is not available for complete stack back, custom header size may be ordered. Give window opening size and custom header size.

- Panels will be built to cover the window opening size
- The track, header, and valance will be built to the custom size requested
- Available on bypass and bifold track systems
- Outside mount only

ORDER ENTRY TIP: Enter the opening size as the ordered width. Choose “no” for stack back and then place desired finished size in the customer header field.

Bifold Track System Stack Back Option

The stack back option allows for the shutter panels to clear the window opening, creating an unobstructed view. **Panels made to cover window. Header/track made larger so panels stack off glass.**

Measure only the frame-to-frame area for outside mount with stack back. Factory will calculate the correct stack back needed for full stack back. Custom header also available.

System consists of a single top track and optional bottom track.

Calculating Approximate Stack Back: Factory will add additional width to ordered size for stack back. Amounts vary, depending on the number of panels. Total (approximate) amount that will be added to the window opening size is calculated by multiplying the number of panels by 1½. This determines the approximate overall unit width.

Specialty Styles

Bifold Track System

- System consists of top and bottom track and quarter-round as standard
- Available in all louver sizes
- All wood color options are available
- Available with Front Tilt (1-way and 2-way closure), Hide-A-Tilt™ (1-way and 2-way closure), and Split Tilt
- Divider rail with split tilt not available on the same shutter

Configuration Options:

- Outside mount with box-out
- Outside mount with box-out and stack back
- Inside mount

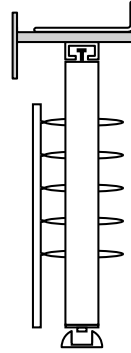
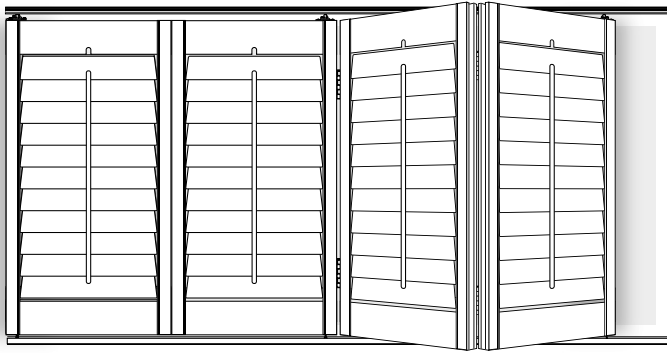

Bottom Track Detail

Installer screws the track to the floor and attaches “quarter-round” up to the face of the track (and along the back of the track, if needed).

NOTES:

1. Factory does not supply adhesive, trim nails, or other fasteners to install quarter-round.
2. Factory always furnishes bottom track. Installer determines whether bottom track is needed.

Bifold Track System: Mounting Options

OUTSIDE MOUNT NOTES—WITH FACTORY ADDITIONS

Width Measurement (using the required box-out): If no window trim: measure window opening (WO) size. If window trim: measure outside edge of trim to outside edge of trim. **Factory will add 5" to your overall ordered width.**

NOTE: When measuring, add more for bullnose so that frames mount completely on flat surface.

Height Measurement: If no window trim: measure from floor surface to top of window opening. If window trim: measure to top of window trim. **Factory will add 3½" to your overall ordered height.**

Other Measurement Considerations: If there are window moldings, factory can accommodate only up to ½" thick molding when using 3½" louvers and Hide-A-Tilt.

Track and Header Board: Unit includes track installed to header board. Header is 3½" deep and ¾" thick.

Valances and Returns: One top treatment style is available: standard 2¾" single-bead valance. Valance returns are included and wrap around the outside of the box-out (frame). Refer to the valance options.

Box-Out (side frames): Side frames are required for securing the pivot set of outermost panels. Box-out frame is ¾" x 3½".

Stack Back Available: Optional stack back is available for outside mount bifold shutters. Custom stack back widths are available.

INSIDE MOUNT NOTES—WITH FACTORY DEDUCTIONS

Width Measurement: Order WO (window opening) and provide net window width. **Factory will make ½" deduction from the track for proper fit.**

Height Measurement: Order WO (window opening) and provide net window height. **Factory will make approximately ½" deduction. Carriers are adjustable.**

Minimum window depth requirement 3⅝". Standard edge gap (edge of panel to inside of window edge) is ⅜" on both sides of the units.

Track and Header Board: Unit includes track installed to header.

Valances and Returns: One top treatment style is available: standard 2¾" single-bead valance. No returns are available. Valance ends are not mitered. Refer to the valance options.

Box-Out (side frames): Box-out is not available. The pivot set of outermost panels is secured to the inside of window opening.

Stack back not available.

Specialty Styles

Bifold Shutters Minimum and Maximum Width (order sizes by panel configuration)

Panel Configuration	Example of Shutter Unit Configurations Using Various Panel Combinations	Outside Mount (with side frame)		Outside Mount with Stack Back (with side frame)		Inside Mount	
		Order WO Size		Order WO Size		Order WO Size	
		Minimum Width (inches)	Maximum Width (inches)	Minimum Width (inches)	Maximum Width (inches)	Minimum Width (inches)	Maximum Width (inches)
LL/RR		17	49	14	48	21	54
LLRR/LLLL/RRRR		38	100	32	95	41	105
LLLLRRRR		80	205	70	194	80	209

Wood Bifold Height Minimum and Maximum		
Options	Minimum (inches)	Maximum (inches)
Outside Mount	17 $\frac{1}{8}$	120 $\frac{1}{8}$
Inside Mount	15 $\frac{1}{8}$	122 $\frac{1}{8}$

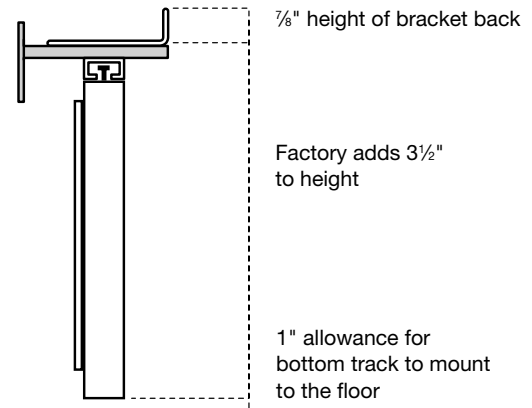

Setting Bracket Height (for outside mount)

For Wall Mount Bifold Shutter System

Top of Angle Bracket to Floor:

Top of bracket is 5 $\frac{3}{8}$ " above ordered height.

NOTE: Side frames determine the mounting height. Bottom edge of side frame is meant to touch the floor surface.

Bifold Track System Divider Rail Requirements

- Divider rail required over 84" ordered height
- Tracks wider than 144" are spliced; header and valance may be spliced over 96" wide

Bifold Valance Options

2 $\frac{1}{8}$ " Standard Valance



NOTE: Valance keystones available. See "Valance Keystones" section.

Specialty Styles

Sidelight

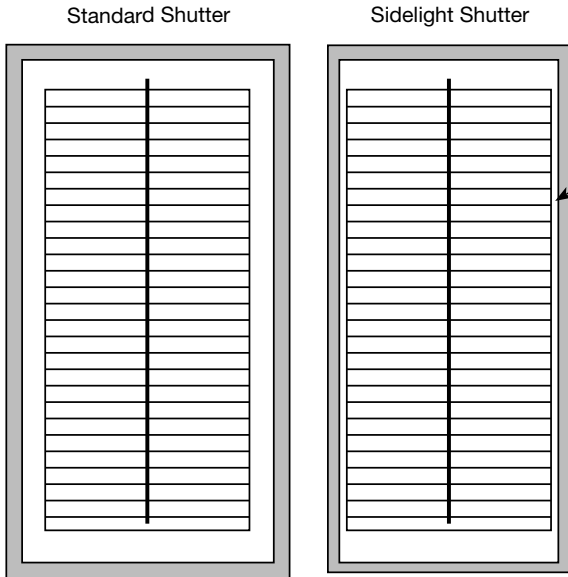

- 2½" and 3½" louvers only
- Low profile L-frame style, similar to sill frame
- 4-sided frame configuration only
- Frame-to-frame (F-F) measuring
- Narrow panel side stile width
- Left or right panel configurations only
- Divider rail never required, but is available
- Buildout is available and is automatically furnished when specifying 3½" louvers; maximum one layer of buildout; buildout is attached at the factory
- Available with Front Tilt (1-way and 2-way closure), Hide-A-Tilt™ (1-way and 2-way closure), and Split Tilt
- Not available as double hung

- Panel side stile = 2"
- Standard L-frame face width = 1"
- Panel side stile = 1⅜"
- Sidelight frame face width = ½"

Minimum and Maximum Sizes						
Width (all louver sizes)				Height		
Minimum Order Size (F-F size) (inches)	Maximum Order Size (F-F size) (inches)	Minimum Finished Panel Width (inches)	Maximum Finished Panel Width (inches)	Minimum Order Size (F-F size) (inches)	Maximum Order Size (F-F size) (inches)	Maximum Order Size (F-F size) (inches)
				2.5" louvers	3.5" louvers	All Louver Sizes
7⅞	13⅞	6	12	11¼	13¼	97¼

Sidelight Frame

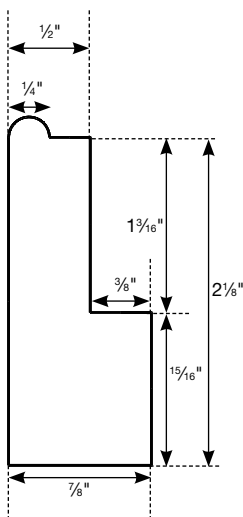

Buildout for Sidelight Frame

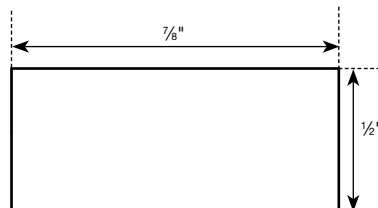

Specialty Styles

Bay Windows

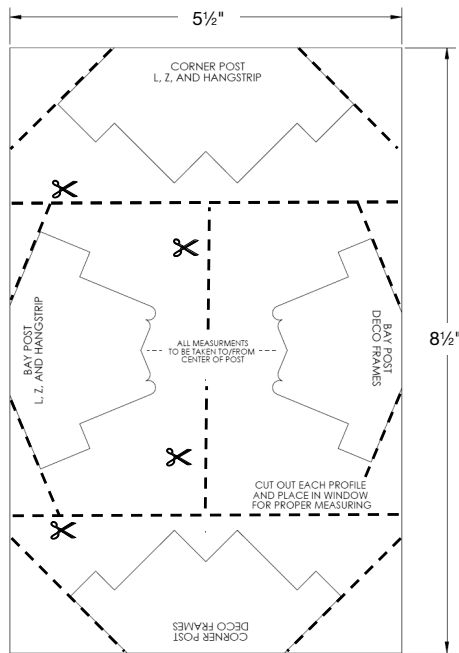

- 135° (degree) angled bays only
- Framed configurations offered:
 - 2-sided framed configurations only
- Unframed configurations offered:
 - Direct mount and hang strip
- All frame styles except tilt-out Z, narrow colonial L, extended standard L, extended narrow colonial L, bullnose Z, craftsman Z, deco, and sill cap available
- T-posts are available (see parameters below)
- No buildout is available
- 2½", 3½", and 4½" louvers
- Split tilt is available as center only (cannot specify)
- Not available as double hung

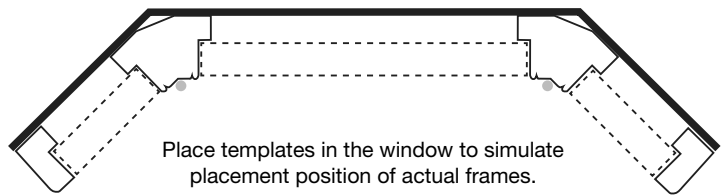

Frame (footprint) template available.
Cut out individual pieces for use during measure.

Measuring Tips

1. For direct mount, hang strip, and Z-frame: order WO. Measure from inner edge of window to center of bay post.
2. For L-frame and deco frame: order F-F. Measure from outside edge of outer frame to center of bay post.
3. For center shutter: measure from center of bay post to center of bay post.

Both measure formats use the (front) center of the bay post as reference points (see small dots on diagram above).

Available Panel Configurations by Window Locations—For Bay Windows

Side Windows: Choose from 1-panel or 2-panel configurations



Center Window: Choose from 1-panel, 2-panel, 3-panel, and 4-panel configurations









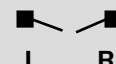

1 Panel	L R	1 Panel	L R
2 Panels	LR LL RR LTR RTR	2 Panels	LR LL RR LTR RTR LTL
3 Panels	LLR LRR LLTR LTLR	3 Panels	LTRR LTLTR LTRTR LRTR
4 Panels	LLRR LLTRR LRTRLR	4 Panels	LTLRTR LTRTLTR

Specialty Styles

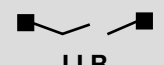
Bay Windows

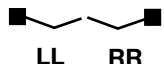
Minimum and Maximum Order Width Sizes by Fold Pattern and by Frame Type

Panel Configurations Available for the Side Windows of the Bay		Direct Mount Hang Strip		Z-Frame		3" Traditional Deco Frame		3½" Curved, Beaded, Deco Frame		L-Frame	
		Order WO		Order WO		Order F-F Size		Order F-F Size		Order F-F Size	
		Minimum (inches)	Maximum (inches)	Minimum (inches)	Maximum (inches)	Minimum (inches)	Maximum (inches)	Minimum (inches)	Maximum (inches)	Minimum (inches)	Maximum (inches)
1 Panel		9 ¹³ / ₁₆	36 ¹³ / ₁₆	10 ¹ / ₁₆	37 ¹³ / ₁₆	12 ¹ / ₁₆	39 ¹ / ₁₆	12 ¹³ / ₁₆	39 ¹³ / ₁₆	10 ¹³ / ₁₆	37 ¹³ / ₁₆
2 Panel		18 ⁸ / ₁₆	72 ⁸ / ₁₆	19 ⁹ / ₁₆	73 ⁸ / ₁₆	20 ¹³ / ₁₆	74 ¹³ / ₁₆	21 ¹ / ₁₆	75 ⁸ / ₁₆	19 ⁹ / ₁₆	73 ⁸ / ₁₆
2 Panel, 1 T-Post		20	74	20 ³ / ₄	73 ³ / ₄	22 ⁵ / ₁₆	75 ⁵ / ₁₆	22 ¹³ / ₁₆	75 ¹³ / ₁₆	21	74
1 Bifold		18 ⁸ / ₁₆	52 ⁸ / ₁₆	19 ⁹ / ₁₆	52 ⁸ / ₁₆	20 ⁷ / ₁₆	54 ⁷ / ₁₆	21 ¹ / ₁₆	55 ⁸ / ₁₆	19 ⁹ / ₁₆	53 ⁸ / ₁₆

Panel Configurations Available for the Center Window of the Bay, Bay Post-to-Bay Post Only (no frame to consider)	Minimum (inches)	Maximum (inches)	
1 Panel		10 ¹ / ₁₆	37 ¹³ / ₁₆
2 Panel		19 ⁹ / ₁₆	73 ⁸ / ₁₆
2 Panel, 1 T-Post		20 ³ / ₄	73 ³ / ₄
1 Bifold		19 ⁹ / ₁₆	53 ⁸ / ₁₆
1 Panel, 1 Bifold		28 ⁸ / ₁₆	89 ⁸ / ₁₆
1 Panel, 1 Bifold, 1 T-Post		29 ⁹ / ₁₆	110 ⁸ / ₁₆
3 Panel, 2 T-Post		30 ¹³ / ₁₆	111 ¹³ / ₁₆
2 Bifold		37 ⁸ / ₁₆	105 ⁸ / ₁₆
2 Bifold, 1 T-Post		38 ⁹ / ₁₆	106 ⁹ / ₁₆
4 Panel, 1 T-Post		38 ⁹ / ₁₆	146 ⁸ / ₁₆
4 Panel, 2 T-Post		39 ⁹ / ₁₆	147 ⁹ / ₁₆
4 Panel, 3 T-Post		40 ⁹ / ₁₆	148 ⁹ / ₁₆

Specialty Styles

Corner Windows

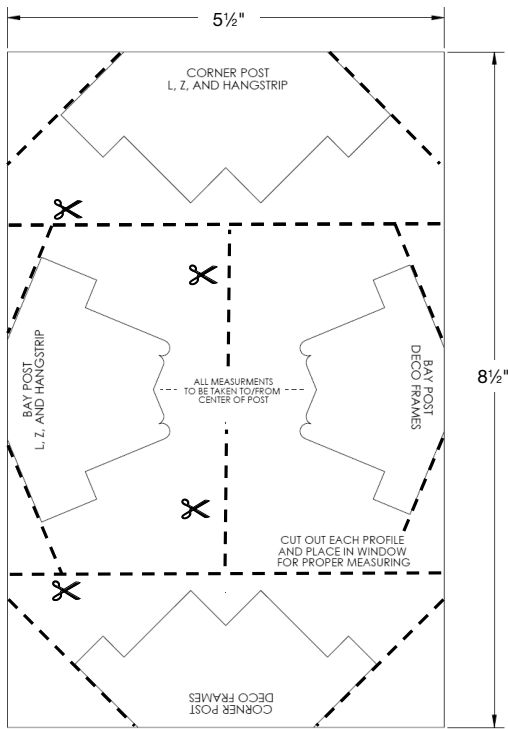

- 90° (degree) angled corners only
- Framed configurations offered:
 - 2-sided framed configurations only
- Unframed configurations offered:
 - Direct mount and hang strip
- All frame styles except tilt-out Z, narrow colonial L, extended standard L, extended narrow colonial L, bullnose Z, craftsman Z, deco, and sill cap available
- T-posts are available (see parameters below)
- No buildout is available
- 2½", 3½", and 4½" louvers
- Split tilt is available as center only (cannot specify)
- Not available as double hung

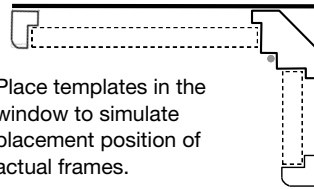

Place templates in the window to simulate placement position of actual frames.

Frame (footprint) template available. Cut out individual pieces for use during measure.

Measuring Tips

1. For direct mount, hang strip, and Z-frame: order WO. Measure from inner edge of window to center of corner post.
2. For L-frame and deco frame: order F-F. Measure from outside edge of outer frame to center of corner post.

Both measure formats use the (front) center of the corner post as reference points (see small dots on diagram above).

Available Panel Configurations for Corner Windows

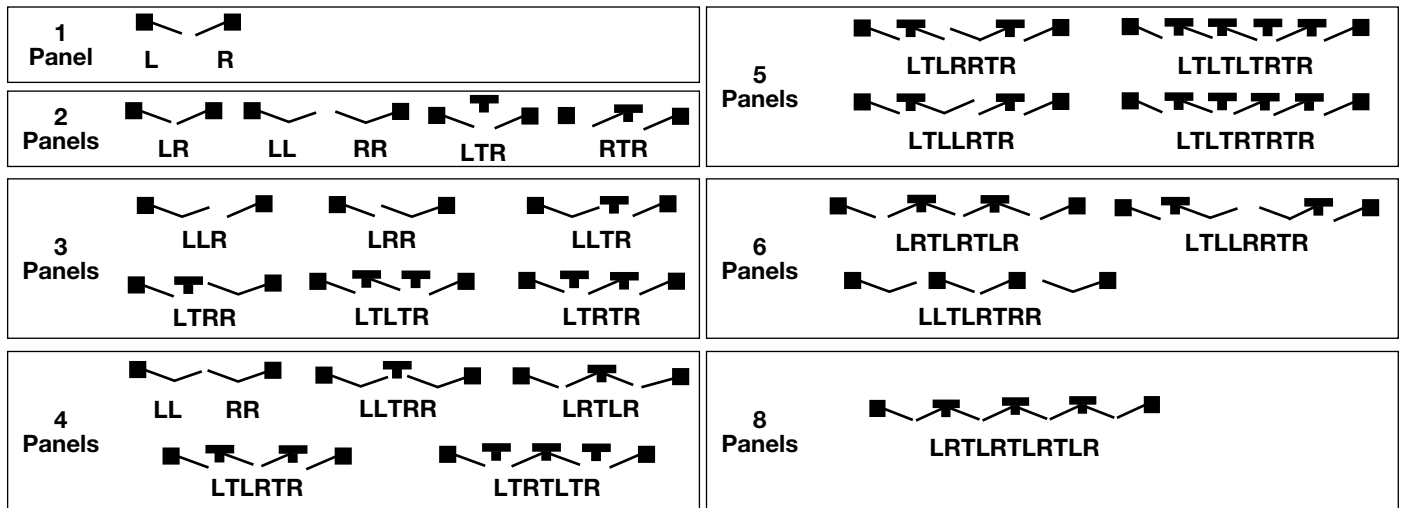

Specialty Styles

Corner Windows

Minimum and Maximum Order Width Sizes by Fold Pattern by Frame Type

Panel Configurations Available for Both Windows of the Corners		Direct Mount Hang Strip		Z-Frame		3" Traditional, Deco Frame		3½" Curved, Beaded, Deco Frame		L-Frame	
		Order WO		Order WO		Order F-F Size		Order F-F Size		Order F-F Size	
		Minimum (inches)	Maximum (inches)	Minimum (inches)	Maximum (inches)	Minimum (inches)	Maximum (inches)	Minimum (inches)	Maximum (inches)	Minimum (inches)	Maximum (inches)
1 Panel		9 ¹³ / ₁₆	36 ¹³ / ₁₆	10 ¹ / ₁₆	37 ¹³ / ₁₆	12 ¹ / ₁₆	39 ¹ / ₁₆	12 ¹³ / ₁₆	39 ¹³ / ₁₆	10 ¹³ / ₁₆	37 ¹³ / ₁₆
2 Panel		18 ⁷ / ₁₆	72 ⁷ / ₁₆	19 ¹ / ₁₆	73 ¹³ / ₁₆	20 ¹³ / ₁₆	74 ¹³ / ₁₆	21 ¹ / ₁₆	75 ⁷ / ₁₆	19 ¹ / ₁₆	73 ¹³ / ₁₆
2 Panel, 1 T-Post		20	74	20 ³ / ₄	73 ³ / ₈	22 ⁵ / ₁₆	75 ³ / ₈	22 ¹³ / ₁₆	75 ¹⁵ / ₁₆	21	74
1 Bifold		18 ⁷ / ₁₆	52 ⁷ / ₁₆	19 ¹ / ₁₆	52 ⁷ / ₁₆	20 ⁷ / ₈	54 ⁷ / ₈	21 ¹ / ₁₆	55 ⁷ / ₁₆	19 ¹ / ₁₆	53 ⁷ / ₁₆
1 Panel, 1 Bifold		27 ¹ / ₄	88 ¹ / ₄	28 ³ / ₈	89 ³ / ₈	30 ³ / ₁₆	91 ³ / ₁₆	30 ⁷ / ₈	91 ⁷ / ₈	28 ³ / ₄	89 ³ / ₄
1 Panel, 1 Bifold, 1 T-Post		28 ¹ / ₄	89 ¹ / ₄	29 ¹ / ₈	90 ¹ / ₈	31 ¹ / ₁₆	92 ¹ / ₁₆	31 ¹ / ₈	92 ¹ / ₈	29 ¹ / ₄	90 ¹ / ₄
3 Panel, 2 T-Post		29	110 ¹ / ₁₆	30 ¹⁵ / ₁₆	111 ¹⁵ / ₁₆	32 ¹ / ₂	113 ¹ / ₂	33 ³ / ₁₆	114 ³ / ₁₆	30 ³ / ₁₆	111 ³ / ₁₆
2 Bifold		36 ⁷ / ₁₆	104 ⁷ / ₁₆	37 ¹ / ₁₆	105 ¹ / ₁₆	39 ¹ / ₄	108 ¹ / ₁₆	39 ¹ / ₁₆	108 ¹ / ₁₆	37 ¹ / ₁₆	105 ¹ / ₁₆
2 Bifold, 1 T-Post		37 ¹ / ₈	105 ¹ / ₈	38 ¹ / ₂	106 ¹ / ₂	40 ¹ / ₁₆	108 ¹ / ₁₆	40 ¹ / ₄	108 ¹ / ₄	38 ¹ / ₄	106 ¹ / ₄
4 Panel, 1 T-Post		37 ¹ / ₈	145 ¹ / ₈	38 ¹ / ₂	146 ¹ / ₂	40 ¹ / ₁₆	148 ¹ / ₁₆	42 ¹ / ₄	148 ¹ / ₄	38 ¹ / ₄	146 ¹ / ₄
4 Panel, 2 T-Post		38 ⁷ / ₁₆	146 ⁷ / ₁₆	39 ¹³ / ₁₆	147 ¹³ / ₁₆	41 ¹ / ₁₆	149 ¹ / ₁₆	42 ¹ / ₁₆	150 ¹ / ₁₆	39 ¹³ / ₁₆	147 ¹³ / ₁₆
4 Panel, 3 T-Post		39 ¹ / ₄	147 ¹ / ₄	41 ¹ / ₈	149 ¹ / ₈	42 ¹ / ₁₆	150 ¹ / ₁₆	43 ¹ / ₈	151 ¹ / ₈	40 ¹ / ₄	148 ¹ / ₄
3 Panel, 1 Bifold, 2 T-Post		47 ¹ / ₈	162 ¹ / ₈	50 ¹³ / ₁₆	165 ¹³ / ₁₆	55 ³ / ₁₆	170 ³ / ₁₆	57	172	50 ³ / ₈	165 ³ / ₈
5 Panel, 4 T-Post		49 ¹⁵ / ₁₆	184 ¹⁵ / ₁₆	53 ¹ / ₈	188 ¹ / ₈	56 ¹ / ₈	192 ¹ / ₈	58 ¹⁵ / ₁₆	193 ¹⁵ / ₁₆	52 ¹⁵ / ₁₆	187 ¹⁵ / ₁₆
2 Panel, 2 Bifold, 2 T-Post		56 ⁷ / ₁₆	178 ⁷ / ₁₆	57 ⁷ / ₁₆	179 ⁷ / ₁₆	59 ¹ / ₈	181 ¹ / ₈	59 ¹ / ₁₆	181 ¹³ / ₁₆	57 ¹³ / ₁₆	179 ¹³ / ₁₆
6 Panel, 2 T-Post		56 ⁷ / ₁₆	218 ⁷ / ₁₆	57 ⁷ / ₁₆	219 ⁷ / ₁₆	59 ¹ / ₈	221 ¹ / ₈	59 ¹³ / ₁₆	221 ¹³ / ₁₆	57 ¹³ / ₁₆	219 ¹³ / ₁₆
8 Panel, 3 T-Post		75 ¹ / ₄	291 ¹ / ₄	76 ¹ / ₈	292 ¹ / ₈	78 ³ / ₁₆	294 ³ / ₁₆	78 ⁷ / ₁₆	294 ⁷ / ₁₆	76 ¹ / ₄	292 ¹ / ₄

General Information

Definitions

Aligning Catch—Concealed magnet and catch plate on back top side of café panels. Used to provide a flush panel alignment.

Astragal—Covers clearance gap between two panels for the purpose of eliminating light gap. Integral to stile.

Bifold—Two panels are hinged together to lie flush against the window or wall.

Bifold Track System—Two or more hinged panels on a track. Panels do not lie flush against the window or wall.

Box-Out Frame—Track system frame option that creates an outside mount application consisting of a three-sided frame with or without a decorative valance.

Buildout—Used in conjunction with frames to move panels away from window, allowing additional clearance for louvers to open.

Bypass Track System—Two or more panels on two-overhead track that slide and pass each other.

Café Style Shutters—Cover the lower portion of an opening. They can be made to any height within product specifications.

Direct Mount—Mounting the shutter panels directly to the window casing.

Divider Rail—A rail that divides the shutter panel into two horizontal sections. It is used to add strength to a tall panel or add a decorative touch.

Double Hung—One set of panels installed over top of another set of panels within one framed window opening. Can be combined with a horizontal T-post if needed.

Guide—Component part used with bypass configurations to lead the panels so that they do not project into the room.

Hang Strip—The mounting frame that is used for inside mount shutter panels.

Inside Mount—A shutter that is mounted on the inside of an opening.

Light Block—Square rail that blocks light between the window sill and the shutter panel. Used with direct mount, hang strip, 2-sided frames, and 3-sided frames.

Louvers—The movable fins inside the shutter panel.

Mouse Hole—Recess at the top/bottom of the panel that the tilt bar rests in when the louvers are completely closed. 1-way closure will give tighter closure than 2-way.

Outside Mount—A shutter that is mounted on the outside of an opening.

Panel—The part of the shutter that consists of a set of louvers, two rails, and two stiles.

Rabbet Stile—A special cut on the stiles that allows the panels to overlap. Helps control light penetration between the panels.

Rails—The top and bottom solid portions of a panel that frame the louvers.

Sill Cap—Decorative wood sill used to cover existing sills that protrude from window.

Split Tilt—Divides louvers into two operable sections by attaching two separate tilt bars.

Square Window—Diagonal measurements must be within ¼" difference. Windows that are not square will need to have the shutter mounted to the outside of the window opening.

Stack Back—Configuration that allows the panels of the bypass or bifold track system to completely slide beyond the window opening.

Stile—The vertical portion of the panel frame to which the louvers are anchored.

Strike Off—Sample color swatch to be approved prior to the production of the order.

Tilt Bar—A vertically mounted bar located on the front of the shutter. Not used to tilt the louvers, but is attached so all louvers connect together and move in unison when a louver is moved.

T-Post—A vertical post that divides the shutter into multiple sections (used with wider shutters). Also used horizontally to separate panels on double hung shutters.

Window Depth—The distance from the surface of the wall to the closest part of the window (examples: latch, crank, frame, etc.).

Care Instructions

Wood Shutters

Occasional light vacuuming with a brush attachment should keep shutters clean. For minor soiled areas, clean with warm water using a clean cotton cloth. Dry with a second clean cotton cloth. For more severe soiling, use a mild detergent diluted to a 5% solution with room temperature water. Clean with a cotton cloth. Wipe area with clear water to remove any detergent residue and dry with cotton cloth.

Adjusting Tension System

The wood shutters that you have purchased include a built-in tension system to allow for adjustments. If you find that your louvers are too loose or are not functioning to your standards, simply follow these instructions. Open the panels fully; on each side of the panel you will find a tension adjustment screw hole. With a small screwdriver, gently turn the screw one to two turns (left to loosen, right to tighten the tension) to your desired resistance level on each side of the panel. Repeat this process for each panel, if necessary.

GRABER®

Graber is a brand of Springs Window Fashions, the Best Experience Company
Graber and the Graber logo are registered trademarks of Springs Window Fashions, LLC.

(7/22) 22-346650

GRABER.

Grabber Wood Shutters Designer US Price List — Effective January 2024

Wood Shutters Pricing

Frame Type	Price (per square foot)	
	Painted	Stained
Hang Strip, Direct Mount	\$77.50	\$86.50
L-Frames, Sidelight Frame	\$81.00	\$90.50
Deco Frames, Z-Frames, Tilt-Out Z-Frame	\$81.00	\$90.50
Bifold/Bypass Track Systems*	\$84.00	\$91.50

Wood Specialty Shutters Surcharges

How to calculate specialty retail price: Calculate overall square footage of the specialty shutter; then multiply the base price of the frame type chosen, and add the surcharge from chart below. For quarter arches, quarter arch panels, all angles, and any arch panel configuration with a T-post and more than four panels, round up width and height to whole number before calculating square foot value.

	Frameless, Hang Strip, Direct Mount	L-Frame	Deco Frame	Z-Frame
Sunburst Arches	\$500	\$575	\$625	\$625
Quarter Sunburst Arches	\$500	\$575	\$625	\$625
Arched Panel Shutters	\$500	\$575	\$625	\$625
Angled Panel Shutters	\$500	\$575	\$625	\$625

Additional Surcharges

Astragal	No charge
Bifold or Bypass Box-Out (outside mount only)*	15%
Bifold or Bypass Stack Back*	5%
Bypass Decorative Valance	No charge
Café Aligning Catch	No charge
Café Shutter with 4-Sided Frame	10%
Custom Color (flat fee per color per order)	\$199 net
Double Hung	15%
French Door Cut-out**	\$500
Hide-A-Tilt™ Bar	10%
Stainless Steel Hinge	5%
Valance Keystones (when requested without a splice)	22
Wood Corner Post and Bay Post	\$61.25
Wood Sill Cap	10%

* Calculate the overall square footage of the bypass or bifold panels, multiply by the per square foot price based on frame type, and use that total to calculate the surcharge for the box-out and/or stack back.

** Calculate the overall square footage of the French Door panel, multiply by the L-Frame per square foot price; then add the surcharge.

Wood Shutters Paint Colors

Angora	1052	Medium Grey	1841	Base White*	2051
Antique White	1026	Pearl	1922	Creamy White*	2729
Base White	1051	Snow White	1909	Silk White*	2922
Crisp White	1712	Snowflake	1603	Competitive Paint	COMP
Dover White	1683	Stepping Stone	1889	Custom Paint	CUSP
Dovetail	1839	Stucco	1963	Unfinished Paint**	UFP
Grey Beige	1817				

*Composite color match.

**Unfinished paint grade comes primed.

NOTE: Color of wood may vary slightly due to the natural characteristics of wood.

Wood Shutters Stain Colors

Allspice*	9821	Golden Oak	1030	Timeless Grey	1847
Base Black	1767	Harbor Grey	1761	True Taupe	1848
Cappuccino	1546	Henna	1949	Truffle	1054
Cherry Wood	1014	Homestead Oak	1943	Walnut	1012
Chestnut	1849	Honey Maple	1013	Wheat	1710
Cognac	1465	Knotty Pine	1515	Competitive Stain	COMS
Dark Cherry	1316	Natural	1007	Custom Stain	CUSS
Dark Walnut	1641	Saddle Brown	1694	Unfinished Stain	UFS
Espresso	1716	Sienna	1685		

NOTE: Color of wood may vary slightly due to the natural characteristics of wood.

*Allspice color number to match horizontal blind = 1821.