

C



Signature
series
by BUDGET BLINDS®

CORNICES, VALANCES, AND
PALLADIAN WINDOW SHELF

COST AND PRODUCT REFERENCE GUIDE

UNITED STATES
SEPTEMBER 2019

 BUDGET®
BLINDS

Style and service for every budget.™

Table of Contents

Features

Wood Characteristics	3
Wood Cornices	4
Wood Valances	4
Composite and Faux Wood Valances	4
Palladian Window Shelf	4

Size Considerations

Cornices and Valances	5
Palladian Window Shelf	5

Options

Wood Cornices	6
Wood Valances	7
Composite and Faux Wood Valances	8
Decorative Keystones	9
Splicing Requirements	9
Palladian Window Shelf	10

General Information

Valance Returns: Horizontal Blinds	11–12
Wood Valance Returns	13–14
Wood Cornice Returns	15–16
Composite and Faux Wood Valance Returns	17
How to Measure for Valance Returns	18
How to Measure and Order Cornices and Valances	19
How to Measure a Special Splice Location	20
Custom Color	20
Mounting Brackets	21
Warranty	22

Price Charts and Options Pricing

Wood Cornice Pricing	23
Decorative Cornice Keystone Pricing	23
Custom Color Pricing	23
Wood Valance Pricing	24
Decorative Wood Valance Keystone Pricing	24
Custom Color Pricing	24
Composite and Faux Wood Valance Pricing	24
Palladian Window Shelf Pricing	24

Features

Wood Characteristics

The wood used to manufacture our wood cornices and valances has many natural characteristics that make it truly unique. Natural variations in color and grain are inherent in the beauty of wood. These variations are within established industry guidelines and should be expected. When two or more pieces of wood are spliced together to create wider valances or cornices, there may be variations in the dye lot and grain between the sections. In addition, cornices and valances may stain slightly darker or lighter than the samples shown in the sample books and selectors.

The following are all natural characteristics of wood:

- Grain—The direction, size, and appearance of wood fibers vary greatly depending on where the wood is cut from within the tree
- Tiger Striping—Occurs when a tree develops wavy grain, due to genetics, soil content, or other natural scenarios
- Burl—Formed from an irregular growth on the outer edge of the tree
- Bird's Eye—Small area on the surface of the board where fibers are contorted to form circular figures that resemble birds' eyes
- Pin Knots—Vary in size, shape, structure, and color
- Mineral Marks—Dark or discolored areas caused by minerals which the tree extracts from the water or soil; can be either a streak or a stain, usually blackish blue
- Shaker/Rustic—Material contains markings that are more extreme than in standard products; the number and degree of marking will vary throughout the blind

Please be assured that these markings in no way affect the durability or the structural integrity of the blind.



Flat Grain



Grain Change



Tiger Striping



Burl/Bird's Eye



Pin Knots



Mineral Marks



Shaker/Rustic

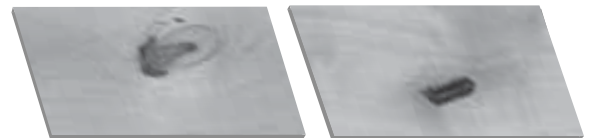

Shaker/Rustic

Features

Wood Cornices

- Crafted from premium North American hardwood
- Fine furniture-quality finish
- L-brackets are included for easy installation
- Cornices are available in all paints and stains to coordinate with Signature Series Wood Blinds, as well as unfinished or custom color
- Keystones are included with spliced cornices and are available as a surcharge option for cornices that do not require a splice

Wood Valances

- Crafted from premium North American hardwood
- Fine furniture-quality finish
- Includes mounting hardware for specified product use
- Valances are available in all paints and stains to coordinate with Signature Series Wood Blinds, as well as unfinished or custom color
- Keystones are included with spliced valances and are available as a surcharge option for valances that do not require a splice

Composite and Faux Wood Valances

- Composite and faux wood options are ideal for a finishing look in a high humidity room
- Includes mounting hardware for specified product use

Palladian Window Shelf

- Crafted from premium North American hardwood
- Fine furniture-quality finish
- Available in all paints and stains to coordinate with Signature Series Wood Blinds, as well as unfinished or custom color
- Create a mounting surface for unique or difficult installations
- Available in depths from 4" to as narrow as 2"
- Mounting hardware included

Size Considerations

Cornices and Valances

Type of Valance or Cornice	Minimum Width		Maximum Width without Splicing		Maximum Width with Splicing	
	Inside Mount (inches)	Outside Mount (inches)	Inside Mount No Returns (inches)	Outside Mount or Inside Mount with Returns (inches)	Inside Mount (inches)	Outside Mount (inches)
2½" Standard Coastal Wood Valance†	8¼	8	100¼	98¾	300¼	298¾
3" Standard Wood Valance	8¼	8	100¼	98¾	300¼	298¾
3½" Flat Wood Valance	8¼	8	100¼	98¾	300¼	298¾
3½" Stately Wood Valance	8¼	8	100¼	98¾	300¼	298¾
4½" Eleganza Wood Valance/Cornice^	8¼	8	100¼	98¾	300¼	298¾
3" Standard Composite or Faux Wood Valance†	8¼	8	106¾	105¾	300	298¾
3½" Stately Composite or Faux Wood Valance†	8¼	8	106¾	105¾	300	298¾
5½" Imperial Wood Cornice^	8¼	8	94	92½	366	366
7½" Imperial Wood Cornice^	8¼	8	94	91¾	366	366
5½" Grand Wood Cornice^	8¼	8	94	91¾	366	366
7½" Grand Wood Cornice^	8¼	8	94	90	366	366

^Inside mount wood cornices that require a keystone cannot be mounted flush to the top of the window casing. There will be approximately a ¼" gap at the top and the installation brackets may be visible with this application.

†Keystones not available on authentic hardwood, coastal wood, distressed wood, in sandblast finish, composite, or faux wood valances.

NOTE: Cornices and valances wider than the widths shown in the chart above will be manufactured in multiple sections. The sections must be assembled during installation. Customer may request specific locations for the splices as long as it does not exceed our maximum single piece size. All requests for additional cornice or wood valance splices require a keystone. The keystone surcharge applies to each additional splice.

These formulas are used to calculate BACKSIDE valance measurements by product type.

Product Type	Mount Type	Formula	
		No returns	With returns
All Except: • Woven Wood Drapes • Sheer Verticals • iD Fabric Roman Shades • Other Applications	Inside mount	OW - 1/16"	OW + 1/4"
	Outside mount	OW + 1/2"	OW + 3/4"
Woven Wood Drapes	Inside mount	OW - 1/16"	OW + 1/2"
	Outside mount	No returns OW + 1/2"	With returns OW + 1"
Sheer Verticals	Inside mount	No returns OW - 1/16"	With returns Ordered width
	Outside mount	No returns OW + 1/4"	With returns OW + 1/2"
iD Fabric Roman Shades	Inside mount	No returns OW - 1/16"	With returns OW + 3 1/2"
	Outside mount	No returns OW + 1/4"	With returns OW + 4"
Other Applications	Inside mount	No returns Ordered width	With returns Ordered width
	Outside mount	No returns Ordered width	With returns Ordered width

These formulas are used to calculate BACKSIDE cornice measurements by product type.

Product Type	Mount Type	Formula	
		No returns	With returns
All Except: • Woven Wood Drapes • Sheer Verticals • iD Fabric Roman Shades • Other Applications	Inside mount	OW - 1/16"	OW + 3/4"
	Outside mount	OW - 1/16"	OW + 1"
Woven Wood Drapes	Inside mount	OW - 1/16"	OW + 1"
	Outside mount	No returns OW - 1/16"	With returns OW + 1"
Sheer Verticals	Inside mount	No returns OW - 1/16"	With returns OW + 1/2"
	Outside mount	No returns OW - 1/16"	With returns OW + 2"
iD Fabric Roman Shades	Inside mount	No returns OW - 1/16"	With returns Ordered width
	Outside mount	No returns Ordered width	With returns Ordered width

If the product option of other is selected during entry, the backside cornice/valance measurement will be the exact width entered. There will be no additions or deductions taken. Cornice or valance return size must be specified. Soft drapery falls within the 'other applications' category.

Palladian Window Shelf

	Minimum Width Inside Mount Only (inches)	Maximum Width Inside Mount Only (inches)	Minimum Depth (inches)	Maximum Depth (inches)
Palladian Window Shelf	7	96	2	4

NOTE: Inside mount application only. The finished shelf will be ordered width less 1/16". The shelf is designed for end mounting, no center supports are available. End mounting brackets must be mounted to a flat vertical surface. If installation is inside an arch, the top of the palladian shelf must be mounted at or below the start of the arch curve. Shelf can be installed in a vertical application to divide a large window. Depending on the width of the window opening and the weight of the blind or shade, deflection up to 1/2" may occur.

Options

Wood Cornices

- Crafted from premium North American hardwood
- Fine furniture-quality finish
- Installation hardware is included for easy installation
- Cornices available in all paints and stains to coordinate with Signature Series Wood Blinds, as well as unfinished or with custom color
- Inside mount has straight cut ends, no returns, no dust cover
- Outside mount has mitered corners, returns, and a dust cover* to conceal the top of the blind
- Custom returns may be ordered for outside mount up to 8"; minimum return is 1/2"
- Cornices not available on bay or corner windows
- Single side return available; opposite end will be straight cut

*Dust cover is unfinished and will not match selected color.

NOTE: Wood cornice will be shipped separate from blinds. Manufacturer recommends installing blind and cornice at the same time.

Grand Wood—Outside Mount



Grand Wood—Inside Mount

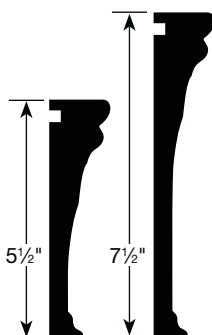

Grand Wood Cornice

Available in either a 5 1/2" or 7 1/2" size and in all colors listed below.

Imperial Wood Cornice

Available in either a 5 1/2" or 7 1/2" size and in all colors listed below.

Paint Colors

Basic White	91051
Buttermilk	91026
Cameo	91055
Classic White	91712
Creamy Grey	91817
Custom Color*	CUSP
Misty Harbor	91889
Misty Morn	91963
Shimmer	91603
Silver Fox	91841
Snowball	91683
Subtle Touch	91839
Tranquility	91059
White Elegance	91850

Stain Colors

Brownstone	91045	Moccasin	91851
Byrnwood	91710	Mochachino	91759
Carmel	91546	Natural	91036
Chestnut	91694	Nut Butter	91836
Custom Color*	CUSS	Paprika	91039
Ember	91038	Safari	91849
Garden Path	91852	Tahoe	91041
Grey Flannel	91058	Tobacco Leaf	91949
Heritage	91465	Unfinished	91717
Ironwood	91054	Wenge	91641

Imperial Wood—Outside Mount



Imperial Wood—Inside Mount

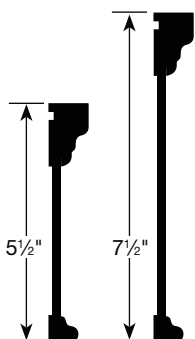

Eleganza Wood—Outside Mount



Eleganza Wood—Inside Mount



Eleganza Wood Cornice

Available in 4 1/2" size and in all colors listed below.

Paint Colors

Basic White	91051
Buttermilk	91026
Cameo	91055
Classic White	91712
Creamy Grey	91817
Custom Color*	CUSP
Misty Harbor	91889
Misty Morn	91963
Sandblast Shimmer†	SB603
Sandblast Silver Fox†	SB841
Shimmer	91603
Silver Fox	91841
Snowball	91683
Subtle Touch	91839
Tranquility	91059
White Elegance	91850

Stain Colors

Brownstone	91045	Mochachino	91759
Byrnwood	91710	Natural	91036
Carmel	91546	Nut Butter	91836
Chestnut	91694	Paprika	91039
Custom Color*	CUSS	Safari	91849
Ember	91038	Shaker	91515
Garden Path	91852	Tahoe	91041
Grey Flannel	91058	Tobacco Leaf	91949
Heritage	91465	Unfinished	91717
Ironwood	91054	Wenge	91641
Moccasin	91851		

*Custom color: see pricing section for net surcharge per color.

†Keystones are not available in sandblast finish, but will come in matching paint color in a smooth finish.

Options

Wood Valances

- Painted and stained valances crafted from premium North American hardwood
- Fine furniture-quality finish
- Returns for inside mount must be specified; if valance is a replacement, specify 1/2" return for cord tilt or motorized tilt and 3/4" for wand tilt or slat sizes greater than 2"
- Inside mount has straight cut ends, no returns
- Outside mount has mitered corners and returns
- Custom returns may be ordered for both inside and outside mount up to 8"; minimum return is 1/2"
- Valances only available on bay and corner windows if bay and corner application is available on entire product line selected
- Single side return available; opposite end will be straight cut

NOTE: Wood valance will be shipped separate from blinds. Manufacturer recommends installing blind and valance at the same time.

Standard—Outside Mount



Standard—Inside Mount



Stately—Outside Mount



Stately—Inside Mount



Flat—Outside Mount



Flat—Inside Mount



Eleganza—Outside Mount



Eleganza—Inside Mount



Standard Valance

3" available in all colors at bottom of page.
2 1/2" available in coastal wood, not available with keystones.

Coastal Wood Colors

Grey 91072
Pelican Grey . . . 91049



3 1/2" Stately Valance

Available in all colors at bottom of page.
Available in distressed wood and authentic hardwood; not available with keystones.

Distressed Wood Colors

Bark 91070
Light Coal 91572

Authentic Hardwood Colors

Cherry C9007
Maple M9007
Walnut W9007



3 1/2" Flat Valance

Available in all colors at bottom of page.



4 1/2" Eleganza Wood Valance

Available in all colors at bottom of page.

Paint Colors

Basic White 91051	Sandblast Shimmer† . . SB603
Buttermilk 91026	Sandblast Silver Fox† . SB841
Cameo 91055	Shimmer 91603
Classic White 91712	Silver Fox 91841
Creamy Grey 91817	Snowball 91683
Custom Color* CUSP	Subtle Touch 91839
Misty Harbor 91889	Tranquility 91059
Misty Morn 91963	White Elegance 91850

Stain Colors

Brownstone 91045	Natural 91036
Byrnwood 91710	Nut Butter 91836
Carmel 91546	Paprika 91039
Chestnut 91694	Rustic Carmel R1546
Custom Color* CUSS	Rustic Grey Flannel . . . R1058
Ember 91038	Rustic Hickory R1071
Garden Path 91852	Safari 91849
Grey Flannel 91058	Shaker 91515
Heritage 91465	Tahoe 91041
Ironwood 91054	Tobacco Leaf 91949
Moccasin 91851	Unfinished 91717
Mochachino 91759	Wenge 91641

*Custom color: see pricing section for net surcharge per color.

†Keystones are not available in sandblast finish, but will come in matching paint color in a smooth finish.

Options

Composite and Faux Wood Valances

- Composite and faux wood valance options are ideal for a finished look in a high humidity room
- Includes mounting hardware for specified product use
- Returns for inside mount must be specified; if valance is a replacement, specify 1/2" return for cord tilt or motorized tilt and 3/4" for wand tilt or slat sizes greater than 2"
- Inside mount has straight cut ends, no returns
- Outside mount has mitered corners and returns

- Custom returns may be ordered for both inside and outside mount up to 8"; minimum return is 1/2"
- Valances only available on bay and corner windows if bay and corner application is available on entire product line selected
- Single side return available; opposite end will be straight cut
- Not available with keystones

NOTE: Composite and faux wood valances will be shipped separate from blinds. Manufacturer recommends installing blind and valance at the same time.

Standard—Outside Mount



Standard—Inside Mount

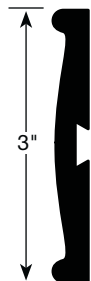

3" Standard Composite and Faux Wood Valance

Add a classic touch to any room.

Available in all colors listed at the bottom of page.

Stately—Outside Mount



Stately—Inside Mount



3 1/2" Stately Composite and Faux Wood Valance

Add a decorative element to the window.

Available in all colors listed at the bottom of page.

Composite Colors

Basic White	92051
Buttermilk	92026
Pure White	92922
Shade Grey	92174
Sweet White	92729

Premium Faux Wood Colors

Byrnwood	92710
Chestnut	92694
Ember	92038
Modest Grey	92230
Paprika	92039
Pumpnickel	92706
Rouge	92316
Shadow	92707
Skipping Stone	92738
Spice	92685
Tahoe	92041

Faux Wood Colors

Cream	85078
Cream Sandblast†	85953
Divine White	85035
Divine White Sandblast†	85951
Milk White	85058
Milk White Sandblast†	85304
Shade Grey	85174
Whisper White	85630
Whisper White Sandblast†	85299
White Sand	85742

†Standard valance will be textured. Stately valance will be color coordinated in a smooth finish.

Options

Decorative Keystones



- Decorative keystones are required on wood cornices and valances that require splicing
- The keystones will be equally spaced unless special splice locations are requested at time of order
- Keystones can be requested on wood cornices without a splice at time of order
 - Minimum width with a keystone: 12"
 - Maximum number of keystones: 3
- Keystones will be stained or painted to match the valance or cornice ordered as standard; optional different color selection available
- Keystones not available on authentic hardwood, coastal wood, distressed wood, in sandblast finish, composite, or faux wood valances
- All inside mount applications will have a slight light gap at the top of the cornice or valance when installed with a keystone
- Keystones cannot be added to existing valances or eleganza cornices because the keystones require splicing at the time of order

Splicing Requirements

Profile	Number of Sections	Number of Keystones	No Returns		With Returns (inside dimensions)	
			Minimum (inches)	Maximum (inches)	Minimum (inches)	Maximum (inches)
2½" Standard Coastal Wood Valance*	1	0	8	100¼	8	98¾
3" Standard Wood Valance	2	1	100⅞	200½	98⅞	198¾
3½" Flat Wood Valance	3	2	200⅞	300¾	198⅞	298¾
3½" Stately Wood Valance	1	0	8	95	8	95
4½" Eleganza Wood Valance	2	1	95⅞	190¾	95⅞	190¾
4½" Eleganza Cornice	3	2	190⅞	285¼	190⅞	285¼
	4	3	285⅞	300	285⅞	300
	1	0	8	94	8	92½
5½" Imperial Cornice	2	1	94⅞	187⅞	92⅞	185⅞
	3	2	187⅞	280⅞	185¼	278¼
	4	3	280⅞	366	278⅞	366
5½" Grand Cornice	1	0	8	94	8	91¾
	2	1	94⅞	186⅞	91⅞	184⅞
	3	2	186¾	279¾	184⅞	276¾
5½" Grand Cornice	4	3	279⅞	366	276⅞	366
	1	0	8	94	8	90
	2	1	94⅞	186	90⅞	182
7½" Grand Cornice	3	2	186⅞	278	182⅞	274
	4	3	278⅞	366	274⅞	366

*Keystones not available.

Outside Mount

- Wood cornices and valances requiring a splice will include a keystone (see chart above for details)

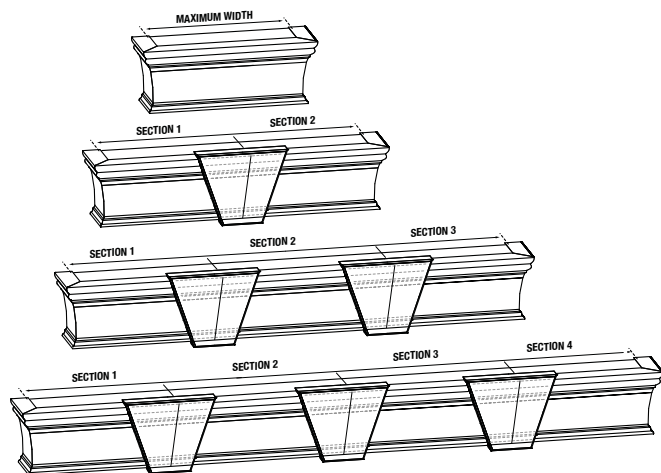

Inside Mount

- Wood valances 100¼" or wider and cornices 94" or wider will require a keystone

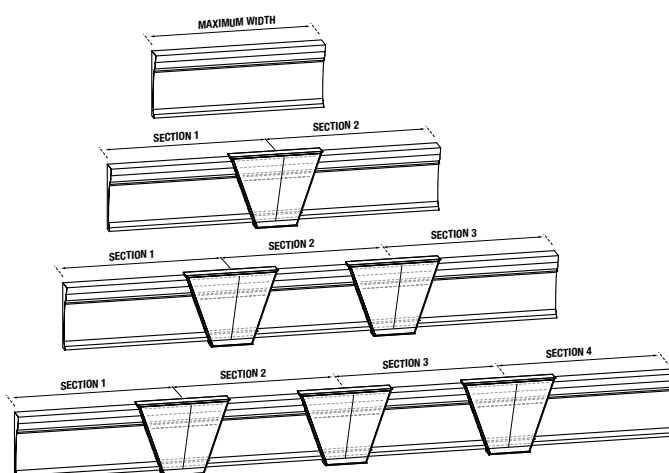

Options

Palladian Window Shelf

A wood shelf or header that may be installed in applications lacking a window frame for mounting a blind. Blinds or other window treatments may be installed either above or below the shelf.

- Created from premium North American hardwood
- Use with any Signature Series blind or shade
- Ideal for arch top windows
- Use as a divider for long windows
- Easy mounting brackets included
- Available in all paints and stains to coordinate with Signature Series Wood Blinds, as well as unfinished or with custom color
- Available in depths from 4" to as narrow as 2"

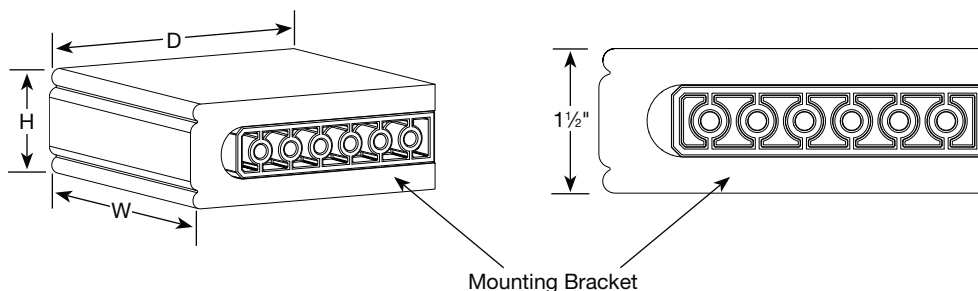



Paint Colors		Stain Colors	
Basic White	91051	Misty Harbor	91889
Buttermilk	91026	Misty Morn	91963
Cameo	91055	Shimmer	91603
Classic White	91712	Silver Fox	91841
Creamy Grey	91817	Snowball	91683
Custom Color*	CUSP	Subtle Touch	91839
		Tranquility	91059
		White Elegance	91850
Brownstone	91045	Moccasin	91851
Byrnwood	91710	Mochachino	91759
Carmel	91546	Natural	91036
Chestnut	91694	Nut Butter	91836
Custom Color*	CUSS	Paprika	91039
Ember	91038	Safari	91849
Garden Path	91852	Tahoe	91041
Grey Flannel	91058	Tobacco Leaf	91949
Heritage	91465	Unfinished	91717
Ironwood	91054	Wenge	91641

*Custom color: see pricing section for net surcharge per color.

General Information

Valance Returns: Horizontal Blinds

Returns for inside mount must be specified. If valance is a replacement, specify 1/2" return for cord tilt or motorized tilt and 3/4" for wand tilt or slat sizes greater than 2".

Valance Type	Blind Type	Maximum Continuous Width*		Control Type	Standard Valance Returns** (inches)	Full Recess Depth (inches)
		Inside Mount No Returns (inches)	Inside Mount with Returns (inches)			
2 1/2" Standard Valance  Valance Returns 1/2" to 4 5/8": glued 4 11/16" and greater: not glued	2" Coastal Wood [^]	100 1/4	98%	Cord tilt	2 7/8	3 1/4
				Wand tilt	3 3/16	3 7/8
				Cordless wand tilt	3 3/8	3 3/4
				Cordless cord tilt	2 3/4	3 1/16
3" Standard Valance  Valance Returns 1/2" to 4 5/8": glued 4 11/16" and greater: not glued	1" Wood	100 1/4	98%	Wand tilt	2 1/16	2 3/8
	2" Wood 2" Premier Wood 2" Aluminum [†] 2" Vinyl [†]	100 1/4	98%	Cord tilt	2 7/8	3 1/4
				Wand tilt	3 3/16	3 7/8
				Cordless wand tilt	3 3/8	3 3/4
				Cordless cord tilt	2 3/4	3 1/16
	2 3/8" Wood 2 3/8" Premier Wood	100 1/4	98%	Cord tilt	3 3/4	4 1/16
				Wand tilt	3 3/4	4 1/16
				Cordless wand tilt	3 3/16	3 15/16
	Wood Verticals	100 1/4	98%	Cordless cord tilt	3 3/16	3 15/16
				N/A	5 1/2	5 13/16
				Cord tilt	2 7/8	3 1/4
	2" Composite [^]	106 5/8	105%	Wand tilt	3 3/16	3 7/8
				Cordless wand tilt	3 3/8	3 3/4
				Cordless cord tilt	2 3/4	3 1/16
Cord tilt				3 15/16	4 1/4	
Wand tilt				3 15/16	4 1/4	
Cordless wand tilt				3 3/4	4 1/8	
2 1/2" Composite [^]	106 5/8	105%	Cordless cord tilt	3 3/4	4 1/8	
			Cord tilt	2 7/8	3 1/4	
			Wand tilt	3 3/16	3 7/8	
			Cordless wand tilt	3 3/8	3 3/4	
			Cordless cord tilt	2 3/4	3 1/16	
			Cord tilt	3 15/16	4 1/4	
2" Premium Faux Wood [^] 2" Faux Wood [^]	106 5/8	105%	Wand tilt	3 3/16	3 7/8	
			Cordless wand tilt	3 3/8	3 3/4	
			Cordless cord tilt	2 3/4	3 1/16	
			Cord tilt	3 15/16	4 1/4	
			Wand tilt	3 15/16	4 1/4	
			Cordless wand tilt	3 3/4	4 1/8	
2 1/2" Premium Faux Wood [^] 2 1/2" Faux Wood [^]	106 5/8	105%	Cordless cord tilt	3 3/4	4 1/8	
			Cord tilt	2 7/8	3 1/4	
			Wand tilt	3 3/16	3 7/8	
			Cordless wand tilt	3 3/8	3 3/4	
			Cordless cord tilt	2 3/4	3 1/16	
			Cord tilt	3 15/16	4 1/4	
3 1/2" Flat Valance  Valance Returns 1/2" to 4 5/8": glued 4 11/16" and greater: not glued	1" Wood	100 1/4	98%	Wand tilt	2 1/16	2 3/8
	2" Wood 2" Premier Wood 2" Aluminum [†] 2" Vinyl [†]	100 1/4	98%	Cord tilt	2 7/8	3 1/4
				Wand tilt	3 3/16	3 7/8
				Cordless wand tilt	3 3/8	3 3/4
				Cordless cord tilt	2 3/4	3 1/16
	2 3/8" Wood 2 3/8" Premier Wood	100 1/4	98%	Cord tilt	3 3/4	4 1/16
				Wand tilt	3 3/4	4 1/16
				Cordless wand tilt	3 3/16	3 15/16
Cordless cord tilt				3 3/16	3 15/16	
Wood Verticals	100 1/4	98%	N/A	5 1/2	5 13/16	

*Continuous valances wider than sizes shown above will have two or more sections spliced together with a keystone. Maximum width for spliced valances is 300 3/4".

**Inside mount returns will be 1/2" for cord tilt or motorized tilt and 3/4" for wand tilt or slat sizes greater than 2".



[^]Keystones not available.

[†]Cordless lift not available.

General Information

Valance Returns: Horizontal Blinds

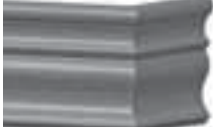
Returns for inside mount must be specified. If valance is a replacement, specify 1/2" return for cord tilt or motorized tilt and 3/4" for wand tilt or slat sizes greater than 2".

Valance Type	Blind Type	Maximum Continuous Width*		Control Type	Standard Valance Returns** (inches)	Full Recess Depth (inches)	
		Inside Mount No Returns (inches)	Inside Mount with Returns (inches)				
 <p>3 1/2" Stately Valance</p> <p>Valance Returns 1/2" to 4 5/8": glued 4 11/16" and greater: not glued</p>	1" Wood	100 3/4	98%	Wand tilt	2 1/16	2 11/16	
	2" Wood 2" Premier Wood 2" Aluminum† 2" Vinyl†	100 3/4	98%	Cord tilt Wand tilt Cordless wand tilt Cordless cord tilt	2 7/8 3 5/16 3 3/8 2 3/4	3 1/2 4 5/8 4 3 3/8	
	2" Distressed Wood^ 2" Premier Authentic Hardwood^	100 3/4	98%	Cord tilt Wand tilt Cordless wand tilt Cordless cord tilt	2 7/8 3 5/16 3 3/8 2 3/4	3 1/2 4 5/8 4 3 3/8	
	2 3/8" Wood 2 3/8" Premier Wood	100 3/4	98%	Cord tilt Wand tilt Cordless wand tilt Cordless cord tilt	3 3/4 3 3/4 3 5/16 3 5/16	4 3/8 4 3/8 4 5/8 4 3/8	
	Wood Verticals	100 3/4	98%	N/A	5 1/2	6 3/8	
	2" Composite^	106 5/8	105%	Cord tilt Wand tilt Cordless wand tilt Cordless cord tilt	2 7/8 3 5/16 3 3/8 2 3/4	3 1/2 4 5/8 4 3 3/8	
	2 1/2" Composite^	106 5/8	105%	Cord tilt Wand tilt Cordless wand tilt Cordless cord tilt	3 15/16 3 15/16 3 3/4 3 3/4	4 3/8 4 3/8 4 3/8 4 3/8	
	2" Premium Faux Wood^ 2" Faux Wood^	106 5/8	105%	Cord tilt Wand tilt Cordless wand tilt Cordless cord tilt	2 7/8 3 5/16 3 3/8 2 3/4	3 1/2 4 5/8 4 3 3/8	
	2 1/2" Premium Faux Wood^ 2 1/2" Faux Wood^	106 5/8	105%	Cord tilt Wand tilt Cordless wand tilt Cordless cord tilt	3 15/16 3 15/16 3 3/4 3 3/4	4 3/8 4 3/8 4 3/8 4 3/8	
	 <p>4 1/2" Eleganza Valance</p> <p>Valance Returns 1/2" to 4 5/8": glued 4 11/16" and greater: not glued</p>	1" Wood	100 3/4	98%	Wand tilt Cord tilt	2 1/16 2 7/8	2 13/16 3 5/8
		2" Wood 2" Premier Wood 2" Aluminum† 2" Vinyl†	100 3/4	98%	Wand tilt Cordless wand tilt Cordless cord tilt	3 5/16 3 3/8 2 3/4	4 5/8 4 1/8 3 1/2
		2 3/8" Wood 2 3/8" Premier Wood	100 3/4	98%	Cord tilt Wand tilt Cordless wand tilt Cordless cord tilt	3 3/4 3 3/4 3 5/16 3 5/16	4 1/2 4 1/2 4 5/8 4 5/8
Wood Verticals		100 3/4	98%	N/A	5 1/2	6 1/4	

*Continuous valances wider than sizes shown above will have two or more sections spliced together with a keystone. Maximum width for spliced valances is 300 3/4".

**Inside mount returns will be 1/2" for cord tilt or motorized tilt and 3/4" for wand tilt or slat sizes greater than 2".

^Keystones not available.
†Cordless lift not available.

General Information

Wood Valance Returns			
Valance Type	Control Type	Standard Return Inside Width (inches)	Full Recess Depth (inches)
1" Wood Horizontal Blinds			
3" Standard Wood Valance	Wand tilt	2 ¹ / ₁₆	2 ³ / ₈
3 ¹ / ₂ " Flat Wood Valance	Wand tilt	2 ¹ / ₁₆	2 ³ / ₈
3 ¹ / ₂ " Stately Wood Valance	Wand tilt	2 ¹ / ₁₆	2 ¹ / ₁₆
4 ¹ / ₂ " Eleganza Wood Valance	Wand tilt	2 ¹ / ₁₆	2 ¹ / ₁₆
2" Wood, Aluminum, and Vinyl Horizontal Blinds			
2 ¹ / ₂ " Standard Coastal Wood Valance [†]	Cord tilt	2 ⁷ / ₈	3 ¹ / ₄
	Wand tilt	3 ⁹ / ₁₆	3 ⁷ / ₈
	Cordless wand tilt	3 ³ / ₈	3 ³ / ₄
	Cordless cord tilt	2 ³ / ₄	3 ¹ / ₁₆
3" Standard Wood Valance*	Cord tilt	2 ⁷ / ₈	3 ¹ / ₄
	Wand tilt	3 ⁹ / ₁₆	3 ⁷ / ₈
	Cordless wand tilt	3 ³ / ₈	3 ³ / ₄
	Cordless cord tilt	2 ³ / ₄	3 ¹ / ₁₆
3 ¹ / ₂ " Flat Wood Valance*	Cord tilt	2 ⁷ / ₈	3 ¹ / ₄
	Wand tilt	3 ⁹ / ₁₆	3 ⁷ / ₈
	Cordless wand tilt	3 ³ / ₈	3 ³ / ₄
	Cordless cord tilt	2 ³ / ₄	3 ¹ / ₁₆
3 ¹ / ₂ " Stately Wood Valance*	Cord tilt	2 ⁷ / ₈	3 ¹ / ₂
	Wand tilt	3 ⁹ / ₁₆	4 ³ / ₁₆
	Cordless wand tilt	3 ³ / ₈	4
	Cordless cord tilt	2 ³ / ₄	3 ³ / ₈
4 ¹ / ₂ " Eleganza Wood Valance*	Cord tilt	2 ⁷ / ₈	3 ⁵ / ₈
	Wand tilt	3 ⁹ / ₁₆	4 ³ / ₁₆
	Cordless wand tilt	3 ³ / ₈	4 ¹ / ₈
	Cordless cord tilt	2 ³ / ₄	3 ¹ / ₂
2³/₈" Wood Horizontal Blinds			
3" Standard Wood Valance	Cord tilt	3 ³ / ₄	4 ¹ / ₁₆
	Wand tilt	3 ³ / ₄	4 ¹ / ₁₆
	Cordless wand tilt	3 ⁹ / ₁₆	3 ¹⁵ / ₁₆
	Cordless cord tilt	3 ⁹ / ₁₆	3 ¹⁵ / ₁₆
3 ¹ / ₂ " Flat Wood Valance	Cord tilt	3 ³ / ₄	4 ¹ / ₁₆
	Wand tilt	3 ³ / ₄	4 ¹ / ₁₆
	Cordless wand tilt	3 ⁹ / ₁₆	3 ¹⁵ / ₁₆
	Cordless cord tilt	3 ⁹ / ₁₆	3 ¹⁵ / ₁₆
3 ¹ / ₂ " Stately Wood Valance	Cord tilt	3 ³ / ₄	4 ³ / ₈
	Wand tilt	3 ³ / ₄	4 ³ / ₈
	Cordless wand tilt	3 ⁹ / ₁₆	3 ³ / ₁₆
	Cordless cord tilt	3 ⁹ / ₁₆	4 ³ / ₁₆
4 ¹ / ₂ " Eleganza Wood Valance	Cord tilt	3 ³ / ₄	4 ¹ / ₂
	Wand tilt	3 ³ / ₄	4 ¹ / ₂
	Cordless wand tilt	3 ⁹ / ₁₆	4 ³ / ₁₆
	Cordless cord tilt	3 ⁹ / ₁₆	4 ³ / ₁₆
Cellular, Pleated, and Classic Roman Shades			
3" Standard Wood Valance	Cord lift	3 ³ / ₄	4 ¹ / ₁₆
	Other lift types	4 ¹ / ₈	4 ⁷ / ₁₆
3 ¹ / ₂ " Flat Wood Valance	Cord lift	3 ³ / ₄	4 ¹ / ₁₆
	Other lift types	4 ¹ / ₈	4 ⁷ / ₁₆
3 ¹ / ₂ " Stately Wood Valance	Cord lift	3 ³ / ₄	4 ³ / ₈
	Other lift types	4 ¹ / ₈	4 ³ / ₄
4 ¹ / ₂ " Eleganza Wood Valance	Cord lift	3 ³ / ₄	4 ¹ / ₂
	Other lift types	4 ¹ / ₈	4 ⁷ / ₈

*Cordless lift not available with 2" aluminum or vinyl blinds.

†Only available with 2" coastal wood blinds.

NOTE: Minimum return width is 1/2"; maximum return width is 8". Valance returns 1/2" to 4⁵/₈" will be glued, 4¹¹/₁₆" and greater cannot be glued.

Valances only available on bay or corner windows if bay or corner application is available on entire product line selected. See cost and product reference guide of product selected for measuring instructions. If the valance is to be used alone (no product selected), the return width must be specified at the time of the order.

General Information

Wood Valance Returns

Valance Type	Control Type	Standard Return Inside Width (inches)	Full Recess Depth (inches)
Cellular Shade Vertical Application			
3" Standard Wood Valance	All	4¼	4⅞
3½" Flat Wood Valance	All	4¼	4⅞
3½" Stately Wood Valance	All	4¼	4⅞
4½" Eleganza Wood Valance	All	4¼	5
Dual Shades			
3" Standard Wood Valance*	All	5½	5⅞
3½" Flat Wood Valance*	All	5½	5⅞
3½" Stately Wood Valance*	All	5½	6⅞
4½" Eleganza Wood Valance	All	5½	6¼
Sliding Panels			
3" Standard Wood Valance	All	5	5⅞
3½" Flat Wood Valance	All	5	5⅞
3½" Stately Wood Valance	All	5	5⅞
4½" Eleganza Wood Valance	All	5	5¼
Solar and Roller Shades			
3" Standard Wood Valance	All	3¾	4⅞
3½" Flat Wood Valance	All	3¾	4⅞
3½" Stately Wood Valance	All	3¾	4⅞
4½" Eleganza Wood Valance	All	3¾	4½
iD Fabric Roman Shades			
3" Standard Wood Valance	Cord lift	4⅞	4⅞
	Other lift types	4⅞	5⅞
3½" Flat Wood Valance	Cord lift	4⅞	4⅞
	Other lift types	4⅞	5⅞
3½" Stately Wood Valance	Cord lift	4⅞	4¾
	Other lift types	4⅞	5½
4½" Eleganza Wood Valance	Cord lift	4⅞	4⅞
	Other lift types	4⅞	5⅞
Sheer Vertical Blinds			
3" Standard Wood Valance	All	6¼	6⅞
3½" Flat Wood Valance	All	6¼	6⅞
3½" Stately Wood Valance	All	6¼	6⅞
4½" Eleganza Wood Valance	All	6¼	7
Vertical Blinds			
3" Standard Wood Valance	All	5½	5⅞
3½" Flat Wood Valance	All	5½	5⅞
3½" Stately Wood Valance	All	5½	6⅞
4½" Eleganza Wood Valance	All	5½	6¼
Woven Wood Drapes			
3" Standard Wood Valance	All	6	6⅞
3½" Flat Wood Valance	All	6	6⅞
3½" Stately Wood Valance	All	6	6⅞
4½" Eleganza Wood Valance	All	6	6¼
Woven Wood Shades			
3" Standard Wood Valance	All	3¾	3⅞
3½" Flat Wood Valance	All	3¾	3⅞
3½" Stately Wood Valance	All	3¾	4¼
4½" Eleganza Wood Valance	All	3¾	4⅞

*Eleganza valance recommended for better headrail coverage.

NOTE: Minimum return width is ½"; maximum return width is 8". Valance returns ½" to 4⅞" will be glued, 4⅞" and greater cannot be glued.

Valances only available on bay or corner windows if bay or corner application is available on entire product line selected. See cost and product reference guide of product selected for measuring instructions. If the valance is to be used alone (no product selected), the return width must be specified at the time of the order.

General Information

Wood Cornice Returns

Cornice Type	Control Type	Standard Return Inside Width (inches)	Full Recess Depth (inches)
1" Wood Horizontal Blinds			
4½" Eleganza Wood Cornice	All	3⅝	4⅞
5½" Imperial Wood Cornice	All	3⅝	4⅞
7½" Imperial Wood Cornice	All	3⅝	4⅞
5½" Grand Wood Cornice	All	3⅝	5⅞
7½" Grand Wood Cornice	All	3⅝	5⅞
2" Wood, Aluminum, and Vinyl Horizontal Blinds			
4½" Eleganza Wood Cornice	All	5	5⅞
5½" Imperial Wood Cornice	All	5	6
7½" Imperial Wood Cornice	All	5	6⅞
5½" Grand Wood Cornice	All	5	6⅞
7½" Grand Wood Cornice	All	5	7
2⅜" Wood Horizontal Blinds			
4½" Eleganza Wood Cornice	All	5	5⅞
5½" Imperial Wood Cornice	All	5	6
7½" Imperial Wood Cornice	All	5	6⅞
5½" Grand Wood Cornice	All	5	6⅞
7½" Grand Wood Cornice	All	5	7
Cellular, Pleated, and Classic Roman Shades			
4½" Eleganza Wood Cornice	All	4⅞	4⅞
5½" Imperial Wood Cornice	All	4⅞	5⅞
7½" Imperial Wood Cornice	All	4⅞	5⅞
5½" Grand Wood Cornice	All	4⅞	5⅞
7½" Grand Wood Cornice	All	4⅞	6⅞
Cellular Shade Vertical Application			
4½" Eleganza Wood Cornice	All	4¼	5⅞
5½" Imperial Wood Cornice	All	4¼	5⅞
7½" Imperial Wood Cornice	All	4¼	5⅞
5½" Grand Wood Cornice	All	4¼	5⅞
7½" Grand Wood Cornice	All	4¼	6¼
Dual Shades			
4½" Eleganza Wood Cornice	All	5½	6⅞
5½" Imperial Wood Cornice	All	5½	6½
7½" Imperial Wood Cornice	All	5½	6⅞
5½" Grand Wood Cornice	All	5½	6⅞
7½" Grand Wood Cornice	All	5½	7½

NOTE: Dual shades can be configured with 7½" cornices. 5½" cornices are available only when dual shade has no cassette with inside mount and cornices are outside mount.

Minimum return width is ½"; maximum return width is 8".

Cornices are not available on bay or corner windows. If the cornice is to be used alone (no product selected), the return width must be specified at the time of the order.

General Information

Wood Cornice Returns

Cornice Type	Control Type	Standard Return Inside Width (inches)	Full Recess Depth (inches)
Sliding Panels			
4½" Eleganza Wood Cornice	All	5	5 ¹³ / ₁₆
5½" Imperial Wood Cornice	All	5	6
7½" Imperial Wood Cornice	All	5	6 ⁵ / ₁₆
5½" Grand Wood Cornice	All	5	6 ⁷ / ₁₆
7½" Grand Wood Cornice	All	5	7
Solar and Roller Shades			
4½" Eleganza Wood Cornice	All	3¾	4 ⁹ / ₁₆
5½" Imperial Wood Cornice	All	3¾	4¾
7½" Imperial Wood Cornice	All	3¾	5 ¹ / ₁₆
5½" Grand Wood Cornice	All	3¾	5 ³ / ₁₆
7½" Grand Wood Cornice	All	3¾	5¾
iD Fabric Roman Shades			
4½" Eleganza Wood Cornice	Cord lift	4 ¹ / ₈	4 ¹⁵ / ₁₆
	Other lift types	4 ⁷ / ₈	5 ¹ / ₁₆
5½" Imperial Wood Cornice	Cord lift	4 ¹ / ₈	5 ¹ / ₈
	Other lift types	4 ⁷ / ₈	5 ⁷ / ₈
7½" Imperial Wood Cornice	Cord lift	4 ¹ / ₈	5 ⁷ / ₁₆
	Other lift types	4 ⁷ / ₈	6 ³ / ₁₆
5½" Grand Wood Cornice	Cord lift	4 ¹ / ₈	5 ⁹ / ₁₆
	Other lift types	4 ⁷ / ₈	6 ⁵ / ₁₆
7½" Grand Wood Cornice	Cord lift	4 ¹ / ₈	6 ¹ / ₈
	Other lift types	4 ⁷ / ₈	6 ⁷ / ₈
Sheer Vertical Blinds			
4½" Eleganza Wood Cornice	All	6¼	7 ¹ / ₁₆
5½" Imperial Wood Cornice	All	6¼	7¼
7½" Imperial Wood Cornice	All	6¼	7 ⁹ / ₁₆
5½" Grand Wood Cornice	All	6¼	7 ¹¹ / ₁₆
7½" Grand Wood Cornice	All	6¼	8¼
Vertical Blinds			
4½" Eleganza Wood Cornice	All	5½	6 ⁵ / ₁₆
5½" Imperial Wood Cornice	All	5½	6½
7½" Imperial Wood Cornice	All	5½	6 ¹³ / ₁₆
5½" Grand Wood Cornice	All	5½	6 ¹⁵ / ₁₆
7½" Grand Wood Cornice	All	5½	7½
Woven Wood Drapes			
4½" Eleganza Wood Cornice	All	6	6 ¹³ / ₁₆
5½" Imperial Wood Cornice	All	6	7
7½" Imperial Wood Cornice	All	6	7 ⁵ / ₁₆
5½" Grand Wood Cornice	All	6	7 ⁷ / ₁₆
7½" Grand Wood Cornice	All	6	8
Woven Wood Shades			
4½" Eleganza Wood Cornice	All	3¾	4 ⁷ / ₁₆
5½" Imperial Wood Cornice	All	3¾	4 ⁵ / ₈
7½" Imperial Wood Cornice	All	3¾	4 ¹⁵ / ₁₆
5½" Grand Wood Cornice	All	3¾	5 ¹ / ₁₆
7½" Grand Wood Cornice	All	3¾	5 ⁵ / ₈

NOTE: Minimum return width is ½"; maximum return width is 8".

Cornices are not available on bay or corner windows. If the cornice is to be used alone (no product selected), the return width must be specified at the time of the order.

General Information

Composite and Faux Wood Valance Returns			
Valance Type	Control Type	Standard Return Inside Width (inches)	Full Recess Depth (inches)
2" Composite and Faux Wood Horizontal Blinds			
3" Standard Composite or Faux Wood Valance	Cord tilt	2 ⁷ / ₈	3 ¹ / ₄
	Wand tilt	3 ³ / ₈	3 ⁷ / ₈
	Cordless wand tilt	3 ³ / ₈	3 ³ / ₄
	Cordless cord tilt	2 ³ / ₄	3 ¹ / ₁₆
3 ¹ / ₂ " Stately Composite or Faux Wood Valance	Cord tilt	2 ⁷ / ₈	3 ¹ / ₂
	Wand tilt	3 ³ / ₈	4 ³ / ₈
	Cordless wand tilt	3 ³ / ₈	4
	Cordless cord tilt	2 ³ / ₄	3 ³ / ₈
2¹/₂" Composite and Faux Wood Horizontal Blinds			
3" Standard Composite or Faux Wood Valance	Cord tilt	3 ¹⁵ / ₁₆	4 ¹ / ₄
	Wand tilt	3 ¹⁵ / ₁₆	4 ¹ / ₄
	Cordless wand tilt	3 ³ / ₄	4 ¹ / ₈
	Cordless cord tilt	3 ³ / ₄	4 ¹ / ₈
3 ¹ / ₂ " Stately Composite or Faux Wood Valance	Cord tilt	3 ¹⁵ / ₁₆	4 ⁹ / ₁₆
	Wand tilt	3 ¹⁵ / ₁₆	4 ⁹ / ₁₆
	Cordless wand tilt	3 ³ / ₄	4 ³ / ₈
	Cordless cord tilt	3 ³ / ₄	4 ³ / ₈
Cellular, Pleated, and Classic Roman Shades			
3" Standard Composite or Faux Wood Valance	Cord lift	3 ³ / ₄	4 ¹ / ₁₆
	Other lift types	4 ¹ / ₈	4 ⁷ / ₁₆
3 ¹ / ₂ " Stately Composite or Faux Wood Valance	Cord lift	3 ³ / ₄	4 ³ / ₁₆
	Other lift types	4 ¹ / ₈	4 ¹ / ₁₆
Cellular Shade Vertical Application			
3" Standard Composite or Faux Wood Valance	All	4 ¹ / ₄	4 ⁹ / ₁₆
3 ¹ / ₂ " Stately Composite or Faux Wood Valance	All	4 ¹ / ₄	4 ¹¹ / ₁₆
Dual Shades			
3" Standard Composite or Faux Wood Valance*	All	5 ¹ / ₂	5 ¹³ / ₁₆
3 ¹ / ₂ " Stately Composite or Faux Wood Valance*	All	5 ¹ / ₂	6 ¹ / ₈
Sliding Panels			
3" Standard Composite or Faux Wood Valance	All	5	5 ⁵ / ₁₆
3 ¹ / ₂ " Stately Composite or Faux Wood Valance	All	5	5 ⁵ / ₈
Solar and Roller Shades			
3" Standard Composite or Faux Wood Valance	All	3 ³ / ₄	4 ¹ / ₁₆
3 ¹ / ₂ " Stately Composite or Faux Wood Valance	All	3 ³ / ₄	4 ³ / ₈
iD Fabric Roman Shades			
3" Standard Composite or Faux Wood Valance	Cord lift	4 ¹ / ₈	4 ³ / ₈
	Other lift types	4 ⁷ / ₈	5 ⁵ / ₁₆
3 ¹ / ₂ " Stately Composite or Faux Wood Valance	Cord lift	4 ¹ / ₈	4 ³ / ₄
	Other lift types	4 ¹ / ₈	5 ¹ / ₂
Sheer Vertical Blinds			
3" Standard Composite or Faux Wood Valance	All	6 ¹ / ₄	6 ¹ / ₁₆
3 ¹ / ₂ " Stately Composite or Faux Wood Valance	All	6 ¹ / ₄	6 ⁷ / ₈
Vertical Blinds			
3" Standard Composite or Faux Wood Valance	All	5 ¹ / ₂	5 ¹³ / ₁₆
3 ¹ / ₂ " Stately Composite or Faux Wood Valance	All	5 ¹ / ₂	6 ¹ / ₈
Woven Wood Drapes			
3" Standard Composite or Faux Wood Valance	All	6	6 ⁵ / ₁₆
3 ¹ / ₂ " Stately Composite or Faux Wood Valance	All	6	6 ⁵ / ₈
Woven Wood Shades			
3" Standard Composite or Faux Wood Valance	All	3 ³ / ₈	3 ¹⁵ / ₁₆
3 ¹ / ₂ " Stately Composite or Faux Wood Valance	All	3 ³ / ₈	4 ¹ / ₄

*Faux wood and composite valances not recommended due to valance heights.

NOTE: Minimum return width is 1/2"; maximum return width is 8". Valance returns 1/2" to 4 5/8" will be glued, 4 11/16" and greater cannot be glued.

Valances only available on bay or corner windows if bay or corner application is available on entire product line selected. See cost and product reference guide of product selected for measuring instructions. If the valance is to be used alone (no product selected), the return width must be specified at the time of the order.

General Information

How to Measure for Valance Returns

Window depths vary considerably depending on the age and style of the window.

Always measure the window depth, regardless of the type of window treatment the client is considering. Knowing the depth when the order is placed can help prevent costly errors.

Use the information in your cost and product reference guide for wood, composite, and faux wood to calculate the needed return length (see previous pages).

To calculate the return width, use this formula:

[standard return width] minus [client window depth] =
special return width to order for inside mount blind

REMEMBER:

- Smallest return width is ½" (inside measurement)
- Returns up to 4⅝" (inside measurement) will be glued
- The width of a return and the width of a valance are measured on the inside (back side) of the valance, not the outside (face) of the valance (see diagram at right)
- Standard return size for 2⅞" blinds—subtract ⅜" prior to determining special return width
- Standard return size for 2½" blinds—subtract ⅜" prior to determining special return width

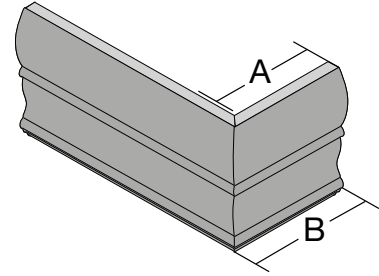

A: Inside Measurement
B: Outside Measurement

General Information

How to Measure and Order Cornices and Valances

Wood cornices and valances are optional with your custom order or as a stand-alone order.

NOTE: Cornices and valances with returns are measured and cut from the **INSIDE** of the miter to ensure the most accurate fit when installed over the headrail or window frame.

Outside Mount

- Cornices and valances are supplied with returns sized to cover the end of the blinds back to the mounting surface
- Custom returns may be ordered up to 8"; minimum return is $\frac{1}{2}$ "
- Cornices include a dust cover to conceal the top of the blind

Inside Mount

- Cornices and valances are supplied without returns and look best when the blinds and valance or cornice can be completely recessed
- Ends of the valance and cornice are straight-cut
- Cornices do NOT have a dust cover and returns are NOT available
- Returns for inside mount valances must be specified; if valance is a replacement, specify $\frac{1}{2}$ " return for cord tilt or motorized tilt and $\frac{3}{4}$ " for wand tilt or slat sizes greater than 2"

Additional Ordering Information

- Please state at the time of order if the valance or cornice return measurements are for the **EXACT** size required so that no additions or deductions are made
- Cornices and valances will be shipped separately from blind
- Manufacturer recommends installing blind and valance/cornice at the same time

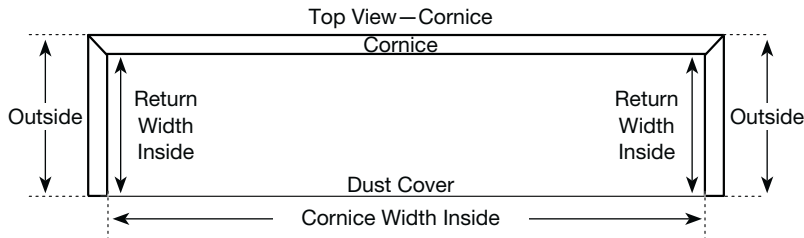

Side View—Cornice

1. Full recess is from front of cornice to wall.
2. Return width is from miter to wall.

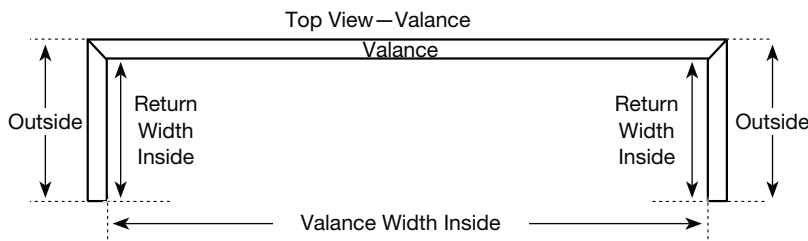
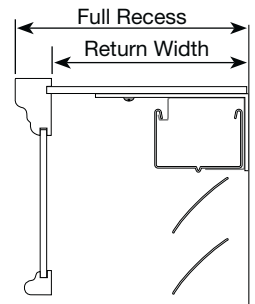

Side View—Valance

1. Full recess is from front of valance to wall.
2. Return width is from miter to wall.
3. Partial recess—subtract actual window recess from return width to arrive at exact return width.

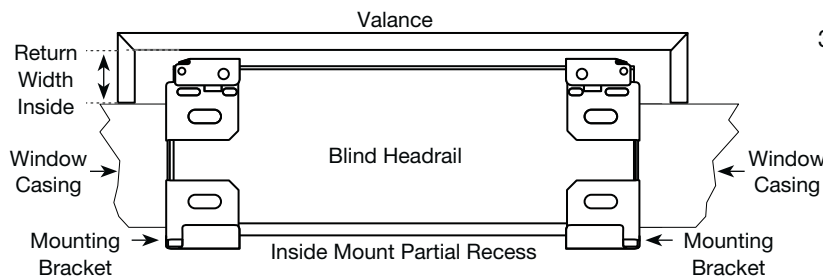
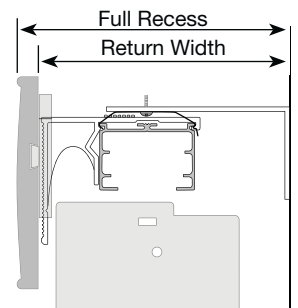

General Information

How to Measure a Special Splice Location

A keystone is supplied for valance and cornice widths that require a splice. Keystone will be equally spaced unless a special splice location is requested at time of order. The placement of the splice will be calculated by the factory using an INSIDE measurement from the mitered corner to the location specified on the order.

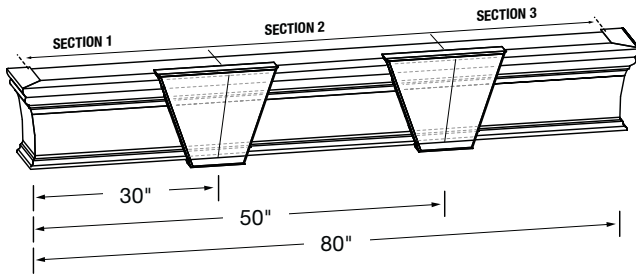

Each splice location should be recorded starting from the LEFT BACKSIDE corner.

EXAMPLE: Overall valance width = 80" backside measurement
First splice from left = 30" backside measurement
Second splice from left = 50" backside measurement

See size considerations for cornice and valance manufacturing formulas to determine exact back width size your cornice or valance will be prior to selecting splice locations.

For keystone pricing, see pricing pages.

NOTE: All measurements need to be from backside.

Custom Color

Signature Series offers the unique option of custom color in either paint or stain. Use the following guidelines when placing your order.

With your order, please send a color chip (at least a 2" square sample) with the color name on the sample. A sample of the color can be requested before blinds are manufactured for your approval. An approval color sample will be automatically sent on orders for six or more blinds. A customer may waive their sample if they do not wish to receive one. Samples usually add approximately two (2) weeks to the lead time of an order. If a color sample is not requested, the sample you provided will be used to manufacture the wood blinds. If the color chip is to be returned to you, please note this on your order.

Please send all color chips to:

Springs Window Fashions, LLC
ATTN: Budget Blinds Custom Color
8467 Rt. 405 South | PO Box 500
Montgomery, PA 17752

NOTE: Due to the nature of the custom color process, manufacturing requires an extended lead time. The four-day manufacturing process does not apply. Lead-times vary depending on sizes and quantities ordered.

General Information

Mounting Brackets

Universal Cornice Mounting Bracket

- L-brackets
- Standard when ordered with
 - Any inside mount cornice
 - Outside mount cornice with returns greater than 1 $\frac{3}{4}$ "

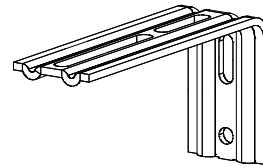

L-Bracket

Short Return Cornice Mounting Bracket

- Bracket and hanger
- Standard when ordered with
 - Outside mount cornice with return width $\frac{1}{2}$ " to 1 $\frac{3}{4}$ "

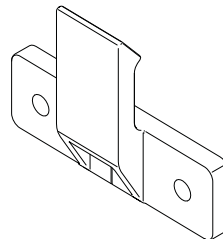

Hanger

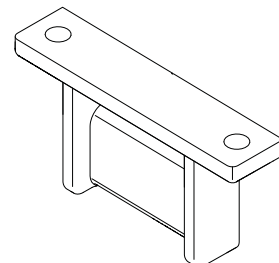

Bracket

Universal Valance Mounting Bracket

- Standard when ordered for any of the following products
 - Cellular, pleated, soft, iD fabric Roman, classic Roman, solar, and roller shades
 - Cellular shade vertical application
 - Dual shades
 - Sliding panels
 - Sheer vertical blinds
 - Vertical blinds
 - Woven wood shades or drapes
 - Other or alone

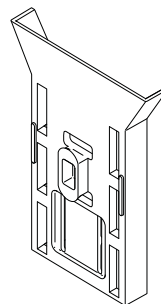

Valance Slide

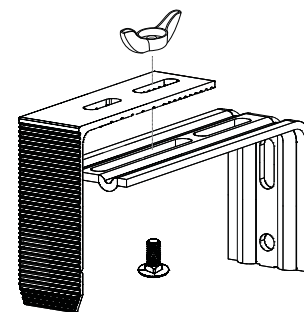

Horizontal Valance Mounting Bracket

- Clip and slide brackets
- Projection width depends on slat size and control type selected
- Standard when ordered for any of the following products
 - 2" aluminum horizontal blinds
 - 2" and 2 $\frac{1}{2}$ " faux wood blinds
 - 2" vinyl horizontal blinds
 - 1", 2", and 2 $\frac{3}{8}$ " wood blinds

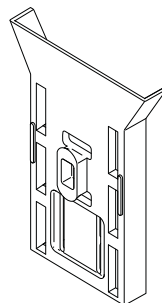

Valance Slide

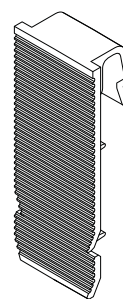

Short Valance Clip
(Available with 1", 2" cord tilt, or motorized tilt)

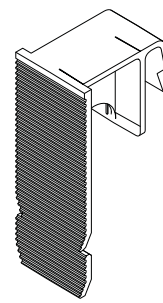

Long Valance Clip
(Available with wand tilt or slat sizes greater than 2")

General Information

Warranty

BUDGET BLINDS EXCLUSIVE FIVE-YEAR “NO QUESTIONS ASKED” LIMITED WARRANTY AND LIMITED LIFETIME WARRANTY PROGRAM

This limited warranty program is available to consumers who purchase Signature Series by Budget Blinds products, other than Shutters and Exterior Solar shades, through participating Budget Blinds retail franchises after November 14, 2005.

FIVE-YEAR “NO QUESTIONS ASKED” LIMITED WARRANTY

OUR OBLIGATION TO YOU:

If, FOR ANY REASON, within five years from the date of purchase, your product should be damaged or become inoperable after the point of installation, the manufacturer will provide a “no questions asked,” ONE-TIME repair or replacement (at our discretion), free of charge. If your product is replaced, the replacement will be of the same product in the same size and color. If color is no longer available, replacement will be of closest equivalent color. This warranty is provided to the original purchaser only and for the original window opening only. Applies only to products made or assembled exclusively from the manufacturer’s materials and components.

LIMITED LIFETIME WARRANTY

OUR OBLIGATION TO YOU:

The manufacturer warrants your Signature Series product by Budget Blinds will be free from original defects in materials or workmanship for as long as the original purchaser owns the product. Under the Limited Lifetime Warranty, the obligations of the manufacturer are limited to the repair or replacement of parts or product found to be defective. The manufacturer is not responsible for shipping costs or labor costs for measuring and taking the shade down or reinstalling the product. If repairs are made under this warranty, the repairs will be made with like or similar parts.

Motorization components and accessories have a five-year limited warranty, excluding batteries.

This warranty does not cover materials or components not sourced by the manufacturer, or conditions or damages caused by accidents, alterations, misuse or failure to follow instructions for measurement, installation, cleaning

or maintenance. In addition, normal wear and tear are not covered by the Limited Lifetime Warranty.

All materials can lose original color intensity or discolor after long exposure to the sun. When left for extended periods in direct sunlight, some materials may yellow or crack. Some materials may warp in high humidity areas. All cords will eventually wear out. The manufacturer considers these normal wear and tear not covered by this warranty.

TO RECEIVE WARRANTY SERVICE, PLEASE:

1. Contact our Customer Service department at 1-877-675-0089 and advise them of the nature of the issue. Customer Service will provide you with information as to how to proceed.
2. Please remember, product returned for warranty claims must be accompanied by the original sales receipt, as well as written details regarding the nature of the problem, location of the product, etc.
3. If your product is returned, please retain a copy of the shipping information for your records.

THIS LIMITED WARRANTY DOES NOT COVER, AND IS INTENDED TO EXCLUDE, ANY AND ALL LIABILITY ON THE PART OF THE MANUFACTURER, WHETHER UNDER THIS LIMITED WARRANTY OR UNDER ANY WARRANTY IMPLIED BY LAW FOR ANY INDIRECT OR CONSEQUENTIAL DAMAGES FOR BREACH HEREOF OR THEREOF, EXCEPT AS EXPRESSLY PROVIDED ABOVE. THE COMPANY HEREBY DISCLAIMS ALL WARRANTIES, EXPRESS OR IMPLIED, TO THE EXTENT PERMITTED UNDER APPLICABLE LAW. ANY IMPLIED WARRANTIES THAT CANNOT BE DISCLAIMED ARE LIMITED IN DURATION TO FIVE YEARS TO THE EXTENT PERMITTED UNDER APPLICABLE LAW.

NOTE: Some states do not allow the exclusion or limitation of incidental or consequential damages, so the foregoing limitation or exclusion regarding such damages may not apply to you. Also, this Limited Warranty gives specific legal rights, and you may also have other rights which vary from state to state. No person is authorized to extend or alter this warranty.

Price Charts

Wood Cornice Pricing

Width up to (inches) →	23	31	36	42	48	54	60	66	72	78	84	90	96	106	116
4½" Eleganza Wood Cornice*	\$211	226	237	249	271	293	307	314	325	335	357	367	593	610	628
5½" Grand Wood Cornice	269	285	296	316	338	360	385	401	416	429	471	477	717	741	762
7½" Grand Wood Cornice	333	352	365	382	400	416	430	451	459	485	520	559	829	860	889
5½" Imperial Wood Cornice	224	241	256	273	296	316	343	356	369	381	407	414	651	671	690
7½" Imperial Wood Cornice	308	330	344	356	371	385	401	416	429	459	504	541	813	837	864

Width up to (inches) →	126	136	146	156	166	176	186	192	216	240	264	283	312*	336	366
4½" Eleganza Wood Cornice*	\$643	660	678	693	711	727	744	972	989	1022	1057	1090	1336		
5½" Grand Wood Cornice	784	807	828	851	873	895	919	1173	1198	1242	1286	1331	1610	1655	1699
7½" Grand Wood Cornice	918	947	977	1006	1035	1063	1095	1360	1389	1448	1507	1565	1861	1921	1978
5½" Imperial Wood Cornice	706	726	745	762	781	799	818	1068	1087	1124	1162	1198	1469	1505	1541
7½" Imperial Wood Cornice	889	913	939	967	992	1016	1044	1302	1329	1380	1431	1482	1771	1819	1872

*Maximum width 300¾".

NOTE: Includes returns (if requested) and mounting hardware.
Minimum width 8" exact.

Decorative Cornice Keystone Pricing

- Keystones are included in the price of a spliced cornice; additional keystones are available as a surcharge
- Surcharge
 - 7½" imperial and grand: \$189 each
 - 5½" imperial and grand: \$178 each
 - 4½" eleganza: \$162 each
- Maximum keystones on single piece cornice is 3

Custom Color Pricing

- Custom color pricing: \$149 net surcharge per color

Price Charts

Wood Valance Pricing

Width up to (inches) →	18	24	28	32	36	42	48	54	60	66	72	78	84	90	96	106	116	126
3" Standard Wood Valance	\$30	33	38	42	50	57	65	83	92	99	107	114	123	130	139	157	171	186
3½" Flat Wood Valance	31	36	39	44	53	60	69	88	97	104	112	122	129	138	149	168	183	200
3½" Stately Wood Valance	31	36	39	44	53	60	69	88	97	104	112	122	129	138	149	168	183	200
4½" Eleganza Wood Valance	32	37	41	46	55	64	73	92	102	110	118	127	137	147	156	178	193	210

Width up to (inches) →	136	146	156	166	176	186	196	206	216	226	236	246	256	266	276	286	296	300
3" Standard Wood Valance	\$201	215	229	243	258	272	286	300	315	329	343	357	372	386	400	414	429	443
3½" Flat Wood Valance	215	230	245	261	276	291	307	322	338	353	369	384	399	414	430	445	461	477
3½" Stately Wood Valance	215	230	245	261	276	291	307	322	338	353	369	384	399	414	430	445	461	477
4½" Eleganza Wood Valance	225	241	257	274	290	305	322	338	353	369	386	402	417	435	450	465	481	498

NOTE: Includes returns (if requested) and mounting hardware.
Minimum width 8" exact. Maximum width 300¾".

Decorative Wood Valance Keystone Pricing

- Keystones are included in the price of a spliced valance; additional keystones are available as a surcharge
- Surcharge
 - 3" standard wood valance: \$22 each
 - 3½" flat wood valance: \$22 each
 - 3½" stately wood valance: \$22 each
 - 4½" eleganza wood valance: \$22 each
- Maximum keystones on a single valance is 3

Custom Color Pricing

- Custom color pricing: \$149 net surcharge per color

Composite and Faux Wood Valance Pricing

Width up to (inches) →	18	24	28	32	36	42	48	54	60	66	72	78	84	90	96	106	116	126
3" Standard Composite and Faux Wood Valance	\$22	25	27	31	35	43	49	61	68	72	80	85	90	98	103	113	123	133
3½" Stately Composite and Faux Wood Valance	23	26	29	32	39	45	52	65	71	75	83	90	97	102	110	120	132	143

Width up to (inches) →	136	146	156	166	176	186	196	206	216	226	236	246	256	266	276	286	296	300
3" Standard Composite and Faux Wood Valance	\$143	153	162	173	183	192	202	213	223	232	243	253	262	272	283	292	302	312
3½" Stately Composite and Faux Wood Valance	154	164	176	187	198	210	220	231	243	254	264	275	287	298	309	320	331	342

NOTE: Includes returns (if requested) and mounting hardware.
Minimum width 8" exact. Maximum width 300¾".
Spliced faux wood valances not available with keystones.

Palladian Window Shelf Pricing

Width up to (inches) →	18	24	28	32	36	42	48	54	60	66	72	78	84	90	96
Palladian Window Shelf	\$60	79	92	105	118	138	156	178	196	217	235	256	275	296	314

NOTE: Minimum width 7" exact.