

ALUMINUM HORIZONTAL BLINDS

Table of Contents

Features and Size Considerations

1" (2.6 cm) Supreme Cordless, 1" (2.6 cm) Supreme, 1" (2.6 cm) Classics, 1" (2.6 cm) Insignia®, ½" (1.3 cm) Supreme Micro, 2" (5.1 cm) Grandeur™	2
Cord Lift Blinds, Depth Requirements for Inside Mount	3
Cordless Lift Blinds, Depth Requirements for Inside Mount	4

Options

Summary	5
Cord Tilt Controls	6
Cordless Lift	6
Motorized Tilt Control	7
Hidden Holes™	8
Inverted Slats	8
Multiple Blinds on One Headrail	9
Multi-Colored Striped Blinds	10
Cloth Tapes and Colors	10
Cut-Out Blinds	11
Bay and Corner Windows	12
Specialty Shapes: Skylights Dual Headrail or Incline Wire Blinds	13-14
Specialty Shapes: Arches	15
Specialty Shapes: Circles	15
Specialty Shapes: Side Cuts, Angle Top and Bottom	16
Specialty Shapes: Octagons, Triangles, Other Shapes	17
Making a Template for Specialty Shape Windows	18
Using the Template Service	18

General Information

Aluminum Color Assortment	19
Color Coordination Chart: ½" (1.3 cm) and 1" (2.6 cm) Aluminum	20
Color Coordination Chart: 2" (5.1 cm) Grandeur Aluminum	21
Ladder Color Coordination: Dual Headrail	21
Stack Height Chart	22
Slat Count Chart	23
Slat Route and Ladder Count Chart, Cordless Supreme, Supreme with Side Mount Brackets, Supreme, Classics, Insignia, Micro Supreme with Side Mount Brackets, Micro Supreme, Grandeur 2" (5.1 cm) Aluminum	24-25
½" (1.3 cm) Micro Supreme and 1" Supreme Product Detail	26
1" (2.6 cm) Cordless Supreme Product Detail	27
1" (2.6 cm) Classics Product Detail	28
1" (2.6 cm) Insignia Product Detail	29
2" (5.1 cm) Grandeur Product Detail	29

Price Charts and Options Pricing

Price Group A: 1" (2.6 cm) Cordless Supreme	31
Price Group B: 1" (2.6 cm) Supreme	32
Price Group C: 1" (2.6 cm) Classics	33
Price Group D: 1" (2.6 cm) Insignia	34
Price Group E: ½" (1.3 cm) Micro Supreme	35
Price Group F: 2" (5.1 cm) Grandeur	36
Price Group G: 1" (2.6 cm) Skylights	37
Price Group H: 1" (2.6 cm) Skylights—Incline Wire Specialty Shapes	38-39
Price Group I: Arches	40
Price Group J: Circles	41
Price Group K: Side Cuts, Inverted Triangles, Angle Top and Bottom	42
Price Group L: Octagons, Triangles	43
Options Pricing	44



Features

1" (2.6 cm) Supreme Cordless

- Great for children's rooms and play areas
- Choose .006 or .008 gauge 1" (2.6 cm) aluminum slats
- Cordless lift system allows blind to be raised and lowered easily with the touch of a finger
- Improved safety for households with children and pets
- Eliminates unsightly cords
- Hidden Holes™ option for additional light control and privacy
- Patented, sleek headrail design features a light-blocking lip, requires no valance (1½" x 2⅜" (3.9 cm x 5.6 cm) aluminum)
- Hidden headrail brackets reduce light gaps
- Gear-driven motor provides smooth, quiet operation
- Our painting process makes slats resist dust, stains, scratches, mold, and mildew
- Color coordinated components provide a finished look
- Cordless handle keeps the blind clean

1" (2.6 cm) Supreme

- The ultimate in light control
- Choose .006 or .008 gauge 1" (2.6 cm) aluminum slats
- Offers the most options in color to suit any decor
- Sleek lightblocking headrail requires no valance (1" x 1½" (2.6 cm x 3.9 cm) steel)
- Tighter ladder spacing provides greater light-blocking ability
- Hidden headrail brackets reduce light gaps
- Hidden Holes option for additional light control and privacy
- Clutch wand tilt releases to prevent damage
- Crash proof cordlock and bottomrail bumpers prevent sill damage
- Precision machined roller system makes it easier to raise blinds
- Our painting process makes slats resist dust, stains, scratches, mold, and mildew
- Color coordinated components provide a finished look

1" (2.6 cm) Classics

- Box brackets make it a snap to install
- Available in skylights and other specialty shapes
- Choose .006 or .008 gauge 1" (2.6 cm) aluminum slats
- 1" x 1½" (2.6 cm x 3.9 cm) steel rectangular headrail
- Deluxe two-slat valance provides a more attractive look
- Clutch wand tilt releases to prevent damage
- Crash proof cordlock and bottomrail bumpers prevent sill damage
- Less porous paint on slats resists dust, stains, scratches, mold, and mildew
- Color coordinated components provides a finished look

1" (2.6 cm) Insignia®

- Your best value
- Fits in windows with narrow jams
- .006 gauge 1" (2.6 cm) aluminum slats
- 1" x 1" (2.6 cm x 2.6 cm) steel square headrail requires minimal depth for a flush mount
- Box brackets make it a snap to install
- Two-slat valance provides a more attractive look
- Clutch wand tilt releases to prevent damage
- Crash proof cordlock prevents sill damage
- Our painting process makes slats resist dust, stains, scratches, mold, and mildew



½" (1.3 cm) Supreme Micro

- Great for French doors and small windows
- .006 gauge ½" (1.3 cm) aluminum slats
- Sleek lightblocking headrail requires no valance (1" x 1½" (2.6 cm x 3.9 cm) steel)
- Hidden headrail brackets reduce light gaps
- Clutch wand tilt releases to prevent damage
- Our painting process makes slats resist dust, stains, scratches, mold, and mildew
- Color coordinated components provide a finished look

2" (5.1 cm) Grandeur™

- Proportionate for large windows
- Maximizes view to outside when slats are open
- .008 gauge 2" (5.1 cm) aluminum slats
- Patented SureTight® headrail (1⅝" x 2¼" (4.2 cm x (5.8 cm)) with premium light-blocking features
- Box brackets make it a snap to install
- Decorative cloth tapes available
- Deluxe channel panel valance provides a sleek finished look
- Crash proof cordlock prevents sill damage
- Our painting process makes slats resist dust, stains, scratches, mold, and mildew
- Color coordinated components provide a finished look

Size Considerations

Cord Lift Blinds										
Styles	Price Group									
		Cord Lift Blinds				Cord Lift Multiple Blinds on One Headrail				
		Width		Height		Width			Height	
		Minimum* inches (cm)	Maximum inches (cm)	Minimum inches (cm)	Maximum inches (cm)	Minimum Panel* inches (cm)	Maximum Panel inches (cm)	Maximum Blind inches (cm)	Minimum Blind inches (cm)	Maximum Blind inches (cm)
½" (1.3 cm) Micro Supreme	E	5½ (14.0) ^a	120 (304.8)	6 (15.3)	5½ (14.0)–22 (55.9): 96 (243.9) ^b 22½ (56.1)–120 (304.8): 144 (365.8)	9 (22.9)	120 (304.8)	192 (487.7)	6 (15.3)	108 (274.4)
1" (2.6 cm) Classics	C	5½ (14.0) ^a	142 (360.7)	6 (15.3)	126 (320.1)	9 (22.9)	142 (360.7)	192 (487.7)	6 (15.3)	126 (320.1)
1" (2.6 cm) Insignia®	D	5½ (14.0) ^a	120 (304.8)	6 (15.3)	126 (320.1)	9 (22.9)	142 (360.7)	192 (487.7)	6 (15.3)	126 (320.1)
1" (2.6 cm) Supreme .006 and .008 Gauge	B	5½ (14.0) ^a	142 (360.7)	6 (15.3)	5½ (14.0)–11½ (30.4): 132 (335.3) 12 (30.5)–35 (88.9): 168 (426.8) 35½ (89.1)–143¾ (365.2): 240 (609.6)	9 (22.9)	142 (360.7)	192 (487.7)	6 (15.3)	126 (320.1)
2" (5.1 cm) Grandeur™	F	9 (22.9) [†]	142 (360.7)	10 (25.4)	126 (320.1)	9 (22.9) [†]	142 (360.7)	142 (360.7)	10 (25.4)	126 (320.1)

*For all inside mount applications—½" (1.3 cm) deduction is taken by manufacturer on overall width; Supreme and Supreme Micro—¾" (1.0 cm).

^a5½" (14.0 cm) to 8¹⁵/₁₆" (22.8 cm) center tilt only

[†]9" (22.9 cm) outside mount, 9½" (24.2 cm) inside mount (9" (22.9 cm) to 11¹⁵/₁₆" (30.4 cm) center tilt only)



12" (30.5 cm) to 16" (40.7 cm) (standard or reversed standard controls)

16¹/₁₆" (40.8 cm) (same side controls)

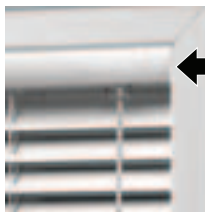
^bBlind width 5½" (14.0 cm)–22" (55.9 cm): 96" (243.9 cm); blind width 22½" (56.1 cm)–120" (304.8 cm): 144" (365.8 cm)

Depth Requirements for Inside Mount			
Blind Type	Headrail Dimensions inches (cm)	 ←	 ←
		Minimum Depth Mount inches (cm)	Flush with Casing inches (cm)
½" (1.3 cm) Micro Supreme	1 (2.6) x 1½ (3.9)	¾ (2.0)	1¾ (4.5)
1" (2.6 cm) Classics	1 (2.6) x 1½ (3.9)	¾ (2.0)	1⅞ (4.8)
1" (2.6 cm) Insignia	1 (2.6) x 1 (2.6)	¾ (2.0)	1⅞ (3.4)
1" (2.6 cm) Supreme	1 (2.6) x 1½ (3.9)	¾ (2.0)	1¾ (4.5)
2" (5.1 cm) Grandeur	1¾ (4.2) x 2¼ (5.8)	¾ (2.0)	2⅞ (6.1)

Size Considerations

Cordless Lift Blinds										
Styles	Price Group									
		Cordless Lift Blinds		Cordless Lift Multiple Blinds on One Headrail						
		Width		Height		Width			Height	
		Minimum* inches (cm)	Maximum inches (cm)	Minimum inches (cm)	Maximum inches (cm)	Minimum Panel* inches (cm)	Maximum Panel inches (cm)	Maximum Blind inches (cm)	Minimum Blind inches (cm)	Maximum Blind inches (cm)
1" (2.6 cm) Supreme .006 Gauge	B	18 (45.8)	96 (243.9)	12 (30.5)	84 (213.4) standard	18 (45.8)	60 (152.4)	120 (304.8) (2 on 1)	12 (30.5)	72 (182.9)
1" (2.6 cm) Supreme .008 Gauge	B				72 (182.9) Hidden Holes™			144 (365.8) (3 on 1)**		

*For all inside mount applications— $\frac{3}{8}$ " (1.0 cm) deduction is taken by manufacturer on overall width.

**The control for the center panel on a three on one cordless lift blind will always be on the left.

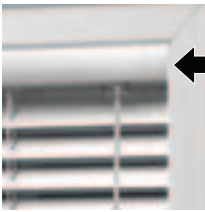
Depth Requirements for Inside Mount			
Blind Type	Headrail Dimensions inches (cm)	 Minimum Depth Mount inches (cm)	 Flush with Casing inches (cm)
Supreme	1 (2.6) x 2 $\frac{3}{16}$ (5.6)	$\frac{3}{4}$ (2.0)	2 $\frac{1}{2}$ (5.4)
Privacy Supreme			

Options

Summary

The following is a chart of options for ½" (1.3 cm), 1" (2.6 cm), and 2" (5.1 cm) aluminum blinds. Options that are available vary by blind type. See specific option for availability and detailed descriptions on the following pages.

Features	Classics	Insignia®	1" (2.6 cm) Supreme	1" (2.6 cm) Supreme Cordless	½" (1.3 cm) Supreme Micro	2" (5.1 cm) Grandeur™
Bay or Corner Window	√	√	√	√	√	√
Cloth Tapes						√
Control Location						
Standard (Tilt Left/Lift Right)	√	√	√	Tilt left	√	√
Reverse	√	√	√	Tilt right	√	√
Same Side	Over 13¾" (35.0 cm)	Over 11 ¹⁵ / ₁₆ " (30.4 cm)	Over 11 ¹⁵ / ₁₆ " (30.4 cm)		Over 11 ¹⁵ / ₁₆ " (30.4 cm)	Over 16" (40.7 cm)
Cut-Outs—to work around any architectural detail	√	√	√		√	√
Double Slats	√		√			
Hidden Holes™—for additional privacy, light control, and a cleaner look			√	√		
Inverted Slat—to bring more light into the room	√	√	√	√		√
Limited Tilt	√	√	√		√	
Motorized Tilt (see motorization price list)						√
Multiple Blinds on One Headrail— for large windows	√	√	√	√	√	√
Multi-Colored Striped Blinds— perfect for themed rooms	√		√	√	√	√
Projection Brackets—1¾" (4.5 cm), 2¾" (7.0 cm), 4¾" (12.1 cm) (outside mount only)	√	√	√	√	√	√
Side Mount	Standard	Standard	√ ^Δ		√ ^Δ	Standard
Sky Poles—for hard to reach controls, used with ring tilt, ring pull, or cordless handle						
3 to 6½ feet (0.9 m–2.0 m)	√		√	√	√	√
5 to 9½ feet (1.5 m–2.9 m)	√		√	√	√	√
Cord Tilt	√					Standard
Wand Tilt	Standard	Standard	Standard	Standard	Standard	√
Ring Tilt and Ring Pull—6" (15.3 cm)	√		√		√	√
Toplock Cord Lock	√		√		√	

^ΔAvailable up to 60" (152.4 cm) wide.

Options

Cord Tilt Controls



Wand Tilt

- No charge
- Standard



Cord Tilt

- No charge
- Standard on 2" (5.1 cm) Grandeur™
- Optional on Classic

2" (5.1 cm) Grandeur Shown



Ring Tilt and Ring Pull

- No charge
- Optional
- Not available on cordless lift
- Optional sky pole available—for surcharge, see options pricing
- Sky pole not available on Insignia®
- Ring pull standard length is 6" (15.3 cm)
(not available from 6¹/₁₆" (15.4 cm)–7¹⁵/₁₆" (20.2 cm))

Cordless Lift



- **For surcharge, see price charts**
- Great for kids' rooms—improved safety
- Choose .006 or .008 gauge 1" (2.6 cm) aluminum slats
- Cordless system allows blinds to be raised and lowered easily with the touch of a finger
- Cordless handle keeps the blind clean
- Eliminates unsightly cords
- Patented, sleek headrail design features a light-blocking lip, requires no valance (1¹/₂" x 2³/₁₆" (3.9 cm x 5.6 cm)) aluminum)
- Hidden headrail brackets reduce light gaps
- Gear-driven motor provides smooth, quiet operation
- Our painting process makes slats resist dust, stains, scratches, mold, and mildew
- Color coordinated components provide a finished look
- Choose the Hidden Holes™ option for more light control and privacy
- Not available with side mount brackets

Options

Motorized Tilt Control



- **For surcharge, see motorization price list**
- 2" (5.1 cm) Grandeur™ only
- Radio Frequency (RF) only
- RF motorization allows blind operation from virtually anywhere in the house without direct line of sight
- Tilts slats on multiple blinds simultaneously or individually
- Remotes, wall switches, and timers available with RF motorization
- Offers enhanced security with the optional wireless RF timer
- Tilt slats when entering or exiting a room with optional wireless wall switches

Follow these steps to determine if your blinds can be motorized:

1. Measure blind width and height.
2. Make sure measurements are within minimum and maximum size specifications listed to the left.
3. Multiply width times height. Round each dimension up to nearest inch for easy calculation to obtain blind size in square inches.
4. Make sure your calculations do not exceed the maximum size specifications listed.
5. Multiple blinds on one headrail are allowed if total size is under 7,200 square inches (4.7 m²). All blinds will operate together with one motor.

Minimum Width	19" (48.3 cm)
Maximum Width	84" (213.4 cm)
Maximum Height	126" (320.1 cm)
Maximum Size	7,200 square inches (4.7 m ²)

EXAMPLE:

84" (213.4 cm) wide x 96" (243.9 cm) high = 8,064 square inches (5.2 m²) (over maximum size)
18" (45.8 cm) wide x 62" (157.5 cm) high = 1,116 square inches (0.7 m²) (under minimum width)
67" (170.2 cm) wide x 84" (213.4 cm) high = 5,628 square inches (3.6 m²) (ok)

Options

Hidden Holes™



Standard



1" (2.6 cm) Hidden Holes

- **For surcharge, see price charts**
- Provides a sleek, elegant look to Graber® 1" (2.6 cm) Supreme and Cordless Supreme mini blinds
- Smaller route holes are placed further back on the blinds so they disappear when the blinds are closed, eliminating annoying light gaps
- Sleek, light blocking headrail is standard and gives the ultimate in privacy and light control

NOTE: This option may cause the bottom of the blind to touch the window when raised. Consider ordering projection brackets if this is a concern.

Inverted Slats



- **For surcharge, see options pricing**
- Bring up to 38% more daylight into your room by choosing the inverted slat option*
- Choose Polished Aluminum (741) for optimum light
- Reflective surface throws more natural light into your room
- Available on 1" (2.6 cm) and 2" (5.1 cm) styles; not available on ½" (1.3 cm) Supreme Micro

*2" (5.1 cm) inverted slat in Polished Aluminum tested 38% more effective transmitting daylight into room than standard 2" (5.1 cm) slat in Polished Aluminum.

Options

Multiple Blinds on One Headrail



• **For surcharge, see price charts**

Two or three blinds can be installed on a single headrail to provide a practical treatment for larger windows or sliding patio doors.

Options: Standard Controls

Two on One Headrail	Left panel	Tilt/left – lift/left
	Right panel	Tilt/right – lift/right
Three on One Headrail	Left panel	Tilt/left – lift/left
	Center panel	Tilt/left – lift/right
	Right panel	Tilt/right – lift/right

The tilt control on cordless lift three on one headrail will always be on the left for the center panel. Non-standard control positions can be requested.

Measuring

1. Measure overall width of the area to be covered. If space permits, an overlap of 1½" (3.9 cm) per side is recommended for outside mounts.
2. Measure the width of the area each blind is to cover. Measure and specify the left blind first, continuing to the right. Allow a minimum of ¼" (0.7 cm) between blinds for operating clearance. **NOTE:** Cordless lift has minimum ⅜" (1.0 cm) gap.
3. Total width of all blinds, plus clearance(s) must equal overall width.
4. Measure height as follows:
 - a. For windows, use standard inside or outside measuring procedures.
 - b. For patio doors, measure height within ¾" (2.0 cm) of floor, either from ceiling or a point at least 6½" (16.6 cm) above the door frame. (Check slat count tables if blind is to completely clear the doorway.)

Ordering

1. Indicate blinds that are to be mounted on one headrail.
2. Specify total width of headrail for inside mount that is the total window opening.
3. Indicate each panel size, specify left blind first, continuing to the right.
4. Specify gaps.
5. Specify control positions, if other than standard.
6. Add applicable surcharge.

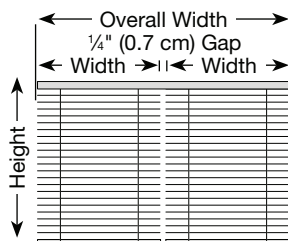

Two Blinds on One Headrail

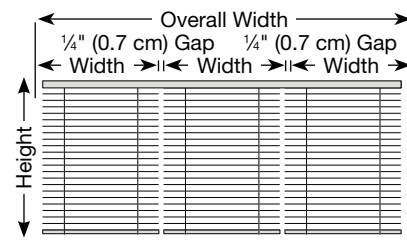

Three Blinds on One Headrail

NOTE: Cordless lift multiple blinds have a ⅜" (1.0 cm) gap between blinds.

Options

Multi-Colored Striped Blinds

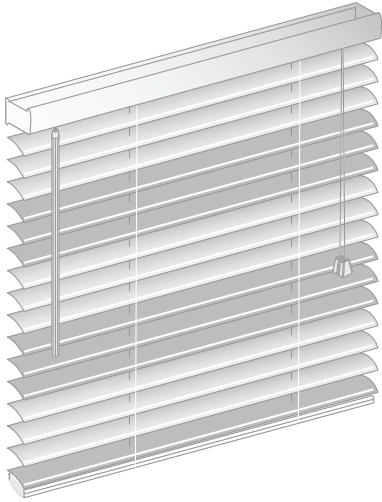

Example of Repeat Pattern:

- 3 Slats—085 Real Red
- 3 Slats—205 White Satin
- 3 Slats—089 True Blue
- 3 Slats—085 Real Red
- 3 Slats—205 White Satin
- 1 Slats—089 True Blue

- **For surcharge, see options pricing**
- Multi-colored blinds are the combination of two or more colors on one blind
- Headrail, bottomrail, and installation brackets will match the color of the top slat
- Maximum of five colors can be used in a repeated or exact striped design
- Ladder supports and lifts will be color coordinated to the headrail color
- Contact customer service to change color coordination
- Not available on 1" (2.6 cm) Insignia®

Specifying Colors

1. Make a diagram of the blind, showing height.
2. From the slat count table, determine the total number of slats.
3. Bottomrail will match the color of the last slat if color pattern consists of at least four color slats in each color group. Otherwise, it will be the color of the headrail.

Ordering

1. Please specify if an exact or repeat pattern.
 - Repeat: color order repeats in a pattern
 - Exact: color order is specifically defined; not in a repeated pattern
2. May specify headrail, bottomrail, ladder, and cord colors.

Example of Repeat Pattern:

Multi-Color Diagram (sample of 1" (2.6 cm) Supreme Aluminum)

Height = 14" (35.6 cm)

Total Slats = 16

Cloth Tapes and Colors



- **For surcharge, see price charts**
- Add a decorative touch with cloth tapes
- Only available on 2" (5.1 cm) Grandeur™ aluminum blinds
- Colors available:

1" (2.6 cm) Solid Tapes		1½" (3.9 cm) Solid Tapes	
Beige	1011	Beige	2011
Black	1033	Black	2033
Cocoa	1297	Chocolate	2353
Duck White	1136	Cocoa	2297
Toffee	1296	Dark Grey	2857
		Duck White	2136
		Light Beige	2137
		Light Grey	2861
		Maroon	2360
		Moss	2500
		Navy	2369
		Pecan	2403
		Taupe	2659
		Toffee	2296
		Wheat	2710
		White	2005
		White Smoke	2617

Options

Cut-Out Blinds

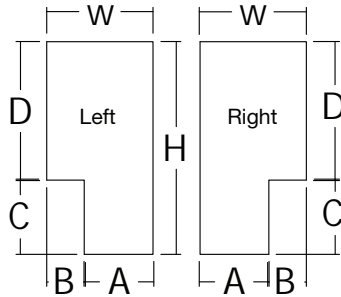
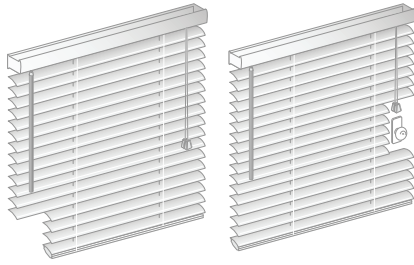

- For surcharge, see options pricing
- Cut-outs are not available on cordless lift blinds

Bottom Corner and Side (Door Knob):

1" (2.6 cm) and ½" (1.3 cm) aluminum: maximum cut-out is blind width minus 10" (25.4 cm). A cut-out over 10" (25.4 cm) requires an intermediate rail.

2" (5.1 cm) vinyl and aluminum: maximum cut-out is 1" (2.6 cm) before the route hole.

"A" minimum is 5" (12.7 cm).



Bottom Center:

"A" and "C" minimum is 5" (12.7 cm).

If "B" is greater than 10" (25.4 cm), there will be an intermediate rail.

Not available on 2" (5.1 cm) blinds.

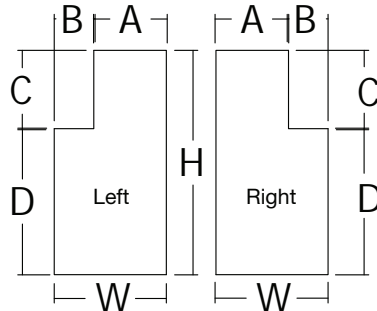
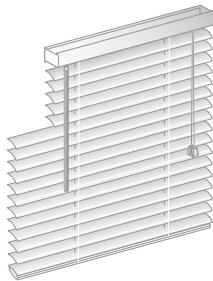

Top Corner:

Maximum cut-out is width is limited to ¼ of total blind width.

"A" minimum is 14" (35.6 cm).

"B" is limited to ¼ total blind width.

If "B" is greater than 8" (20.4 cm) there will be an intermediate rail.

Not available on 2" (5.1 cm) blinds.

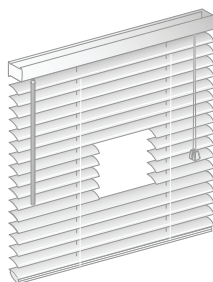

Interior:

Both "A" and "C" minimum width is 5" (12.7 cm).

Maximum width for "B" is blind width minus 20" (50.8 cm).

Not available on 2" (5.1 cm) blinds.

NOTE: Oversized cut-out could require an intermediate support rail. Slats will not lift below intermediate rail.

Options

Bay and Corner Windows

- Made as individual blinds to fit in bay or corner windows
- Each section will have its own control; we recommend opposite corners
- Indicate each blind with bypass or butt; bypass is the blind mounted into the corner; butt is the blind butted up to the other blind

- Manufacturer will take appropriate deductions for proper fit
- Cornices are not available

NOTE: If you do not want vendor to take deductions DO NOT order as bay or corner.

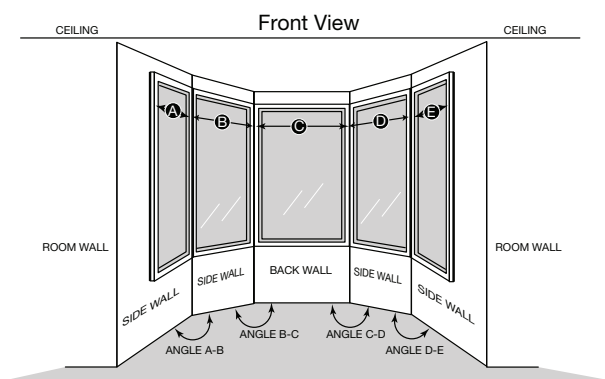
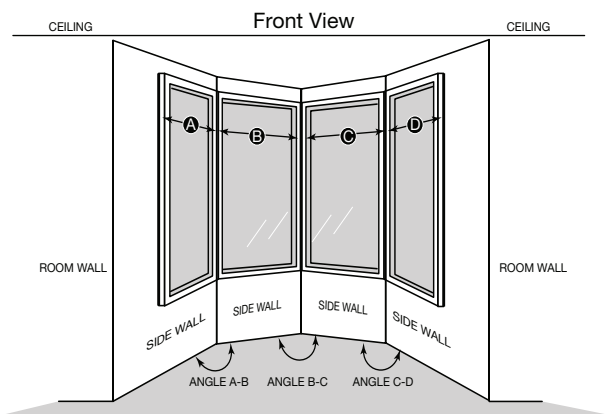
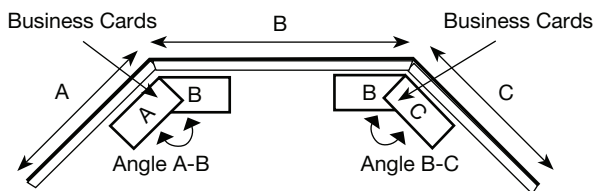
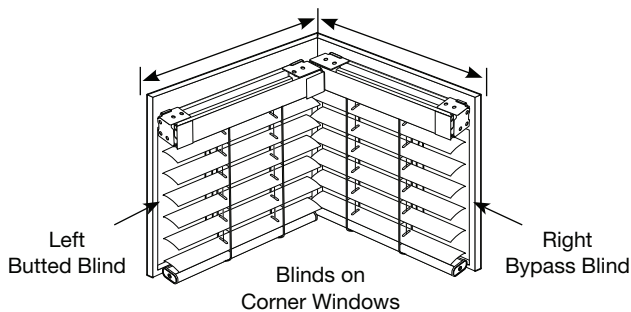

Measuring Information

Corner Window

Measure:

Width of each window from corner to the point you would like to cover.

Three-Sided Bay Window

Measure:

A and C: Width of side windows from the corners to the point you would like the blind to cover.

B: Width of the center window from corner to corner.

Angle A-B: Angle between windows (A) and (B).

Angle B-C: Angle between windows (B) and (C).

Four-Sided Bay Window

Measure:

A and D: Width of side windows from the corners to the point you would like the blind to cover.

B and C: Width of each window from corner to corner.

Angle A-B: Angle between windows (A) and (B).

Angle B-C: Angle between windows (B) and (C).

Angle C-D: Angle between windows (C) and (D).

Five-Sided Bay Window

Measure:

A and E: Width of side windows from the corners to the point you would like the blind to cover.

B, C and D: Width of each center window from corner to corner.

Angle A-B: Angle between windows (A) and (B).

Angle B-C: Angle between windows (B) and (C).

Angle C-D: Angle between windows (C) and (D).

Angle D-E: Angle between windows (D) and (E).

NOTE: Measure bay angle using protractor or angle finder, or use two business cards in bay corner as illustrated above trace angle onto paper and fax to customer service.

Options

Specialty Shapes: Skylights Dual Headrail or Incline Wire Blinds



Incline Wire Features

- For surcharge, see price charts
- Degree from vertical cannot exceed 45 degrees
- Available in all specialty shapes except arches and circles
- Choose .006 or .008 gauge 1" (2.6 cm) aluminum slat
- 1" x 1½" (2.6 cm x 3.9 cm) steel headrail, box design
- Wand tilt left (standard) or right
- Lift cord right (standard) or left
- Color coordinated components provide a finished look
- Sky poles available for easy tilting upon request
- Blinds inclined over 30 degrees from vertical will have marginal tilt operation
- Blinds inclined over 40 degrees from vertical will lower marginally
- Available in special shapes and cord tilt (exception: arch and circle)



Dual Headrail Features

- For surcharge, see price charts
- For windows at more than a 45 degree angle
- Blinds are tilt only
- Choose .006 or .008 gauge 1" (2.6 cm) aluminum slat
- 1" x 1½" (2.6 cm x 3.9 cm) steel headrail, box design
- Ring tilt left (standard) or right
- Color coordinated components provide a finished look
- Sky poles available for easy tilting upon request



Sky Pole

	Incline Wire inches (cm)		Dual Headrail inches (cm)	
Minimum Width	12 (30.5) exact		12 (30.5)	
Maximum Width	122 (309.9)		142 (360.7)	
Minimum Height	10 (25.4)		10 (25.4)	
	Blind Width inches (cm)	Max Height inches (cm)	Blind Width inches (cm)	Max Height inches (cm)
Maximum Height	12 (30.5)–32 (81.3)	126 (320.1)	12 (30.5)–23 (58.5)	126 (320.1)
	32½ (81.6)–57 (144.8)	108 (274.4)	23½ (58.8)–32 (81.3)	102 (259.1)
	57½ (145.1)–92 (233.7)	102 (259.1)	32½ (81.6)–72 (182.9)	90 (228.6)
	92½ (233.9)–122 (309.9)	90 (228.6)	72½ (183.2)–142 (360.7)	80 (203.2)

Options

Specialty Shapes: Skylights Dual Headrail or Incline Wire Blinds

Measuring Information

Inside Mount

- A. Width**—Measure the exact inside width of the window casing from one inside edge to the other in three different places. Record the narrowest measurement.
- B. Height**—Measure the exact height in three different places from the top edge of the opening to the top of the sill. Record the longest measurement.

Do not deduct for headrail clearance gaps. Manufacturer will make all allowances for both width and height. Headrail, tension rail, and slats will be manufactured $\frac{1}{2}$ " (1.3 cm) less than the dimension given as width. Proper deductions will be made for blind height.

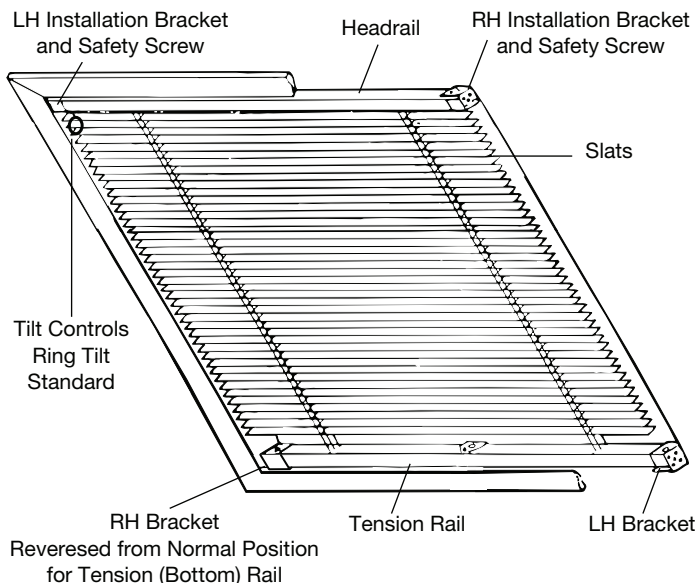
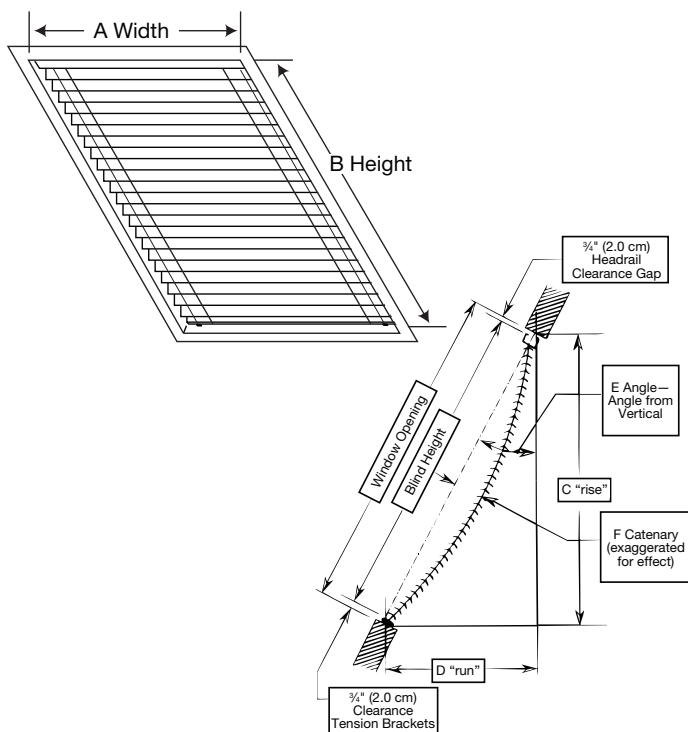

Outside Mount

Measure width and height dimensions and specify as "blind size, cut exact". The manufacturer will not make any allowances for width or height. Headrail, tension rail, and slats will equal dimensions given as width. Blind height will refer to the distance from the top of the upper bracket to the lower bracket of the installed blind and will equal dimension given as height. Do not deduct for headrail and tension rail clearance gaps.

Incline Wire Skylight

Ideal for skylights at up to a 45 degree angle.

NOTE: Blinds can lift and tilt.

Used in windows installed vertically to 45 degrees from vertical (maximum).

- A. Width**—Measure the exact inside width of the window casing from one inside edge to the other in three different places. Record the narrowest measurement.
- B. Height**—Measure the exact height in three different places from the top edge of the opening to the top of the sill. Record the longest measurement.
- C. Rise**—The vertical measurement from the top of a window to the RUN to form a 90 degree angle.
- D. Run**—The horizontal measurement from the bottom of a window to the RISE to form a 90 degree angle.
- E. Angle**—The degree the window is slanted perpendicular (at a right angle) to the floor.
- F. Catenary**—The degree a blind may possibly bow. No measurement needed.

Must give measurements for A and B. C and D are used to calculate the angle (must be less than 45 degrees).

Dual Headrail Skylight

Ideal for skylights for more than a 45 degree angle.

NOTE: Blind is tilt only, no lift.

Options

Specialty Shapes: Arches

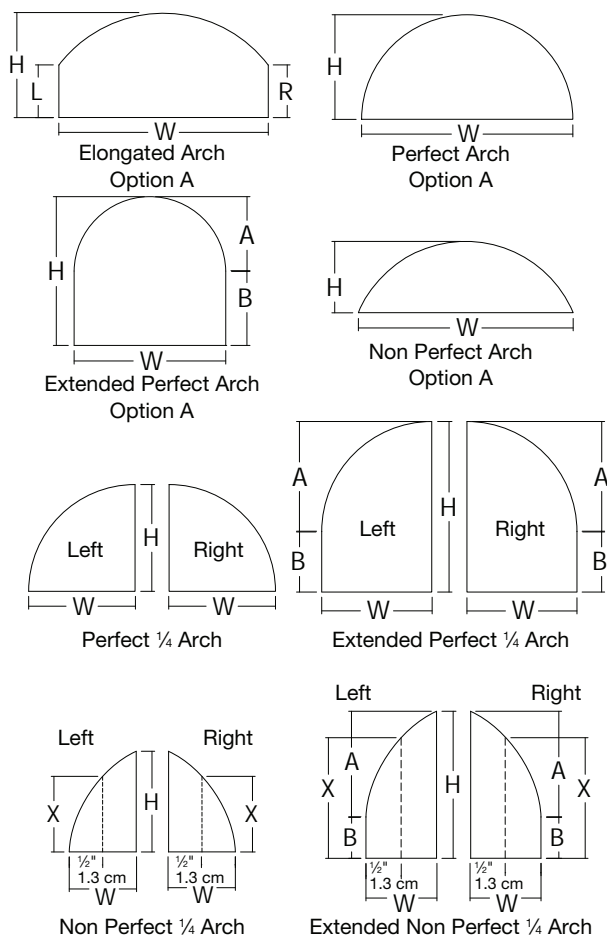

- For surcharge, see price charts
- Choose .006 or .008 gauge 1" (2.6 cm) aluminum slat
- Use 1" x 1" (2.6 cm x 2.6 cm) aluminum headrail
- Valance not available
- A template is required for all arches except perfect arches
- Limitations may apply within each blind type; fax a drawing to customer service to determine availability
- May require 4 to 6 weeks lead time to manufacture

Size Considerations

	Arches inches (cm)	Quarter Arch inches (cm)
Minimum Width	10 (25.4)	12 $\frac{3}{4}$ (32.4)
Maximum Width	Base 142 (360.7)	142 (360.7)
Minimum Height	5 (12.7)	6 (15.3)
Maximum Height	126 (320.1)	126 (320.1)

Controls

Arches: standard, reverse, or same side

Quarter arch: low side

Full tilt: lift depends on shape

Cord tilt and ring tilt: not available

Ordering Information

Full arch: to order, choose specialty option A

Quarter arches: choose specialty option F for left quarter arch and option G for right quarter arch

Only available on 1" (2.6 cm) Classics blinds.

Specialty Shapes: Circles

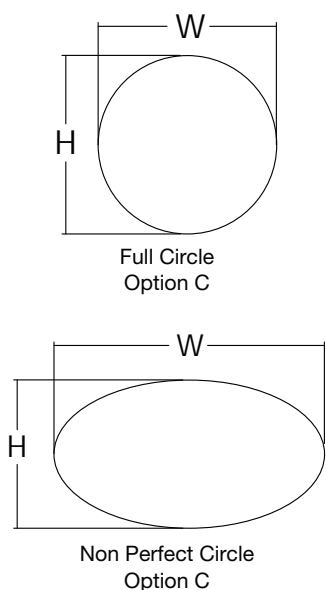

- For surcharge, see price charts
- Choose .006 or .008 gauge 1" (2.6 cm) aluminum slat
- An illustration can be resized
- Uses 1" x 1" (2.6 cm x 2.5 cm) aluminum headrail
- Valance not available
- A template is required for all non perfect circles (see instructions for making a template)
- Limitations may apply within each blind type; fax a drawing to customer service to determine availability
- May require up to 4-6 weeks lead time to manufacture

Size Considerations

Minimum Width	12" (30.5 cm) diameter
Maximum Width/Height	72" (182.9 cm)

Controls

Controls: left or right

Full tilt: no lift

Cord tilt and ring tilt: not available

Options

Specialty Shapes: Side Cuts, Angle Top and Bottom

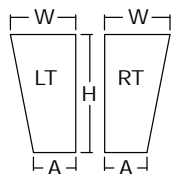

Side Cut
Option V

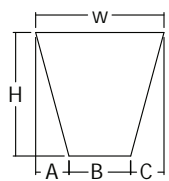

Double Side Cut
Option V

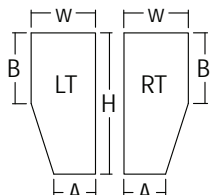

Extended Side Cut
Option V

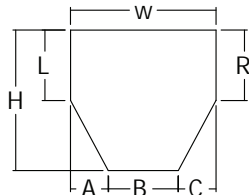

Extended Double Side Cut
Option V

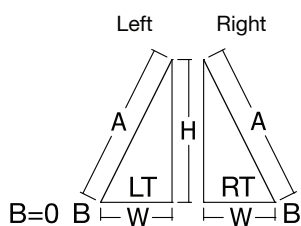

Angle Top
Option P

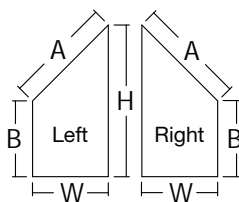

Extended Angle Top
Option P

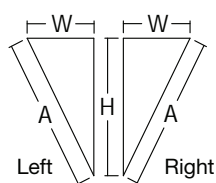

Angle Bottom
Option B

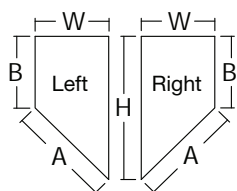

Extended Angle Bottom
Option B

- For surcharge, see price charts
- Choose .006 or .008 gauge 1" (2.6 cm) aluminum slat
- An illustration can be reversed or resized
- Use 1" x 1½" (2.6 cm x 3.9 cm) steel headrail
- Valance not available
- Limitations may apply within each blind type; fax a drawing to customer service to determine availability
- May require up to 4 to 6 weeks lead time to manufacture
- To order, fax a signed drawing with all dimensions to customer service
- Available as incline wire for skylights

Size Considerations	Side Cuts inches (cm)	Angle Top and Bottom inches (cm)
Minimum Bottom Rail	4½ (11.5) exact	12 (30.5) exact
Maximum Width	142 (360.7)	142 (360.7)
Minimum Height	6 (15.3)	12 (30.5)
Maximum Height	126 (320.1)	126 (320.1)
Minimum Headrail	7½ (19.1)	12 (30.5)

Controls

- Side cuts: standard, reverse, or same side (straight side only)
- Angle bottoms: standard, reverse, or same side (dependent on shape)
- Angle and extended angle tops and bottoms: cord lock must be low side
- Full tilt: lift depends on shape
- Cord tilt: available (not available with incline wire)
- Angle bottoms: 60° maximum angle degree; for greater than 60°; order side cut, bottom point will have light gap

Ordering Information

Choose specialty option indicated below illustration.

Options

Specialty Shapes: Octagons, Triangles, Other Shapes

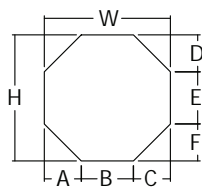

Octagon
Option U

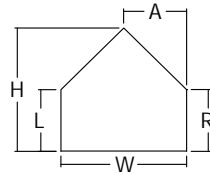

Extended Triangle
Option T

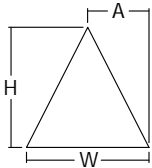

Triangle
Option I

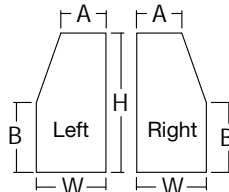

Extended
Inverted Side Cut
Option I

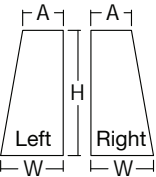

Inverted Side Cut
Option I

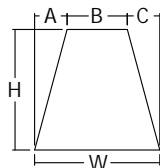

Inverted Double Side Cut
Option I

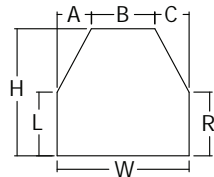

Extended Inverted
Double Side Cut
Option I

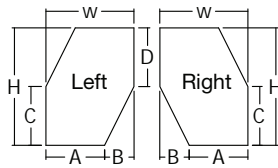

Extended Offset Cut
Option I

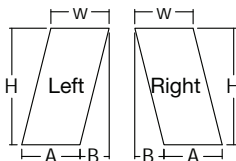

Offset Cut
Option I

- **For surcharge, see price charts**

- Choose .006 or .008 gauge 1" (2.6 cm) aluminum slat
- An illustration can be inverted or reversed or resized
- Headrail is split on many of these shapes
- Use 1" x 1½" (2.6 cm x 3.8 cm) steel headrail
- Valance not available
- Limitations may apply within each blind type; fax a drawing to customer service to determine availability
- May require up to 4-6 weeks lead time to manufacture
- To order, fax a signed drawing with all dimensions to customer service
- Available as incline wire for skylights

Size Considerations	Octagon inches (cm)	Triangle inches (cm)	Other Shapes inches (cm)
Minimum Width	7½ (19.1) exact headrail	12 (30.5)	7½ (19.1) exact headrail
Maximum Width	142 (360.7) or 192 (487.7) maximum total combined headrail segments		
Minimum Height	18½ (46.1)	12 (30.5)	12 (30.5)
Maximum Height	126 (320.1)	126 (320.1)	126 (320.1)

Controls

- Controls: standard, reverse, or same side (straight side only)
- Full tilt left or right: lift depends on shape
- Limited tilt: available
- Cord tilt: available (not available with incline wire)

Ordering Information

Choose specialty option indicated below illustration.

Options

Making a Template for Specialty Shape Windows

1. Tape butcher paper, Kraft, or construction paper over the window opening allowing plenty of overlap.
2. Being careful not to press against the template paper while tracing, draw an exact outline of the window opening. Pressing on the template paper may distort the paper and cause the wrong size to be made.
3. Remove the paper from the window opening. If the blind is an outside mount, add the desired amount of overlap to the window outline and draw a second outline around it to match the shape of the finished blind. **Be sure to erase the inside line.**
4. Mark the dimensions on the template. Check that the template dimensions match your measurements of the actual window opening.
NOTE: Make sure the template is of the window opening, not the glass only measurement.
5. **Cut the shape from the paper.**
6. **PLACE THE TEMPLATE BACK INTO THE WINDOW OPENING TO CHECK FOR PROPER FIT COMPLETELY AROUND.**
7. Indicate on the template
 - “Room side” and “top” on the template
 - Purchase order number
 - Customer’s name
 - Your store name and account number
8. Roll up template and place in a mailing tube.
DO NOT FOLD TEMPLATE.

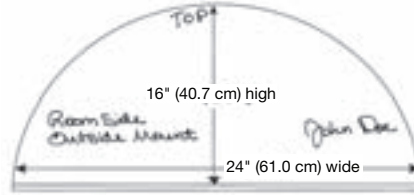

NOTE: This is just a sample for illustration purposes only—other information may be needed for your order.

Mail to: Springs Window Fashions LLC
33 West Third Street
Suite 400
Williamsport, PA 17701
ATTN: Specialty Dept.

NOTE: When mailing, make sure to get a tracking number and note your return address on the mailing tube.

ACCEPTABLE MATERIALS FOR MAKING TEMPLATES:

Kraft paper
Butcher paper
Construction paper

WE WILL NOT ACCEPT TEMPLATES MADE FROM THE FOLLOWING MATERIALS:

Newspaper Plastic
Wax paper Fabric
Tissue paper Roofing paper
Existing arch blinds Wrapping paper

NOTE: If the material used to make a template stretches, tears easily, will not lay flat, or will mark the fabric—IT WILL NOT BE USED.

Using the Template Service

To use the template service, simply:

1. Select template service when entering your order online.
2. Use the template worksheet to determine what measurements you need to supply for each shape.
3. Enter the lettered measurements using line item comments. The comments have been pre-programmed to all of the measurements you need to enter for your special shape.

See note at bottom of price grids if template service fees apply.

General Information

Aluminum Color Assortment

Color Name	Color Number	1" (2.6 cm) Insignia®	1" (2.6 cm) Classics	1" (2.6 cm) Cordless	1" (2.6 cm) Supreme	½" (1.3 cm) Micro Supreme	2" (5.1 cm) Grandeur™
Alabaster	112	✓	✓	✓	✓	✓	✓
Alabaster Pearl	326		✓	✓	✓	✓	✓
Almond	724		✓		✓		✓
Almost White Gloss	065	✓	✓	✓	✓	✓	✓
Aluminum	034	✓	✓	✓	✓	✓	
Ash Metallic	126		✓		✓		✓
Beige	011	✓	✓	✓	✓	✓	
Beige Pearl	328		✓	✓	✓		
Birch White	375		✓		✓		
Black Satin	233	✓	✓	✓	✓	✓	✓
Brushed Aluminum	121	✓	✓	✓	✓	✓	✓
Buff	624	✓	✓		✓		
Burgundy	653	✓	✓	✓	✓		
Cameo	607	✓	✓	✓	✓		
Canary Yellow	009			✓	✓		
Char Brown	062	✓	✓	✓	✓	✓	✓
Coconut	630	✓	✓	✓	✓		
Creamy Beige	670	✓	✓		✓	✓	✓
Crystal White	629	✓	✓	✓	✓	✓	
Desert Sand	625	✓	✓	✓	✓		
Fawn	031	✓	✓	✓	✓	✓	
Fawn Pearl	327		✓	✓	✓	✓	
Flax	541	✓	✓	✓	✓	✓	
Forest Shadow	087	✓	✓		✓		
Granite	044	✓	✓		✓		
Gray Dawn	405		✓		✓		
Gray Haze	983	✓	✓		✓	✓	✓
Greige	122	✓	✓		✓	✓	✓
Hunter Green	154		✓	✓	✓		✓
Ice	778	✓	✓		✓		
Lamplight	904	✓	✓	✓	✓		✓
Lavender Lace	024			✓	✓		
Little Boy Blue	090			✓	✓		
Magnet	648		✓		✓		
Matte White	042	✓	✓		✓	✓	
Mercury	771		✓		✓		
Midnight Blue	057		✓		✓		
Milk Chocolate	060	✓	✓	✓	✓	✓	
Navajo White	376		✓		✓		
Parchment	535	✓	✓		✓	✓	
Pitch Black	033	✓	✓		✓	✓	
Polished Aluminum	741	✓	✓	✓	✓		✓
Princess Pink	023			✓	✓		
Raw Umber	006	✓	✓		✓	✓	✓
Real Red	085	✓	✓	✓	✓		
Rock Gray	399		✓		✓		
Silver	737	✓	✓		✓		
Skyline	680		✓		✓		
Smokey Gray	026	✓	✓		✓	✓	
Snowcap White	386	✓	✓	✓	✓		✓
Stucco	963	✓	✓		✓		✓
Tender Taupe	103		✓		✓		
True Blue	089	✓	✓	✓	✓		
True White	544	✓	✓	✓	✓	✓	✓
U.N. Gray	095	✓	✓		✓		
Vanilla	100	✓	✓	✓	✓	✓	
White Gloss	005	✓	✓		✓	✓	✓
White Pearl	637		✓	✓	✓		
White Satin	205	✓	✓		✓	✓	✓

General Information

Color Coordination Charts: ½" (1.3 cm) and 1" (2.6 cm) Aluminum

Color Number	Color Name	Rail and Brackets	Ladders and Cord	Tassels and Endcaps
005	White Gloss	005	005	005
006	Raw Umber	006	033	006
009	Canary Yellow	009	009	009
011	Beige	011	103	011
023	Princess Pink	023	023	023
024	Lavender Lace	024	024	024
026	Smokey Gray	026	026	026
031	Fawn	031	031	031
033	Pitch Black	033	033	033
034	Aluminum	034	026	026
042	Matte White	042	112	112
044	Granite	044	814	825
057	Midnight Blue	057	008	008
060	Milk Chocolate	060	060	060
062	Char Brown	062	062	062
065	Almost White Gloss	065	112	112
085	Real Red	085	835	025
087	Forest Shadow	087	087	087
089	True Blue	089	089	089
090	Little Boy Blue	090	090	090
095	U.N. Gray	095	033	591
100	Vanilla	100	112	100
103	Tender Taupe	103	103	103
112	Alabaster	112	112	112
121	Brushed Aluminum	034	026	026
122	Greige	122	026	122
126	Ash Metallic	126	126	126
154	Hunter Green	154	154	117
205	White Satin	205	005	005
233	Black Satin	233	033	033
326	Alabaster Pearl	112	112	112
327	Fawn Pearl	031	031	031
328	Beige Pearl	011	103	011
375	Birch White	375	005	005
376	Navajo White	376	112	112
386	Snowcap White	386	005	005
399	Rock Gray	399	026	026
405	Gray Dawn	405	026	026
535	Parchment	535	004	004
541	Flax	541	112	112
544	True White	544	005	005
607	Cameo	670	031	356
624	Buff	624	031	031
625	Desert Sand	625	029	029
629	Crystal White	629	005	005
630	Coconut	630	112	112
637	White Pearl	205	005	005
648	Magnet	648	648	648
653	Burgundy	653	106	106
670	Creamy Beige	670	031	356
680	Skyline	680	591	591
724	Almond	724	004	004
737	Silver	737	026	114
741	Polished Aluminum	034	026	026
771	Mercury	771	026	026
778	Ice	778	778	778
904	Lamplight	904	031	031
963	Stucco	963	026	963
983	Gray Haze	983	026	026

General Information

Color Coordination Charts: 2" (5.1 cm) Grandeur™ Aluminum

Color Number	Color Name	Rail and Brackets	Ladders and Cord	Tilts	Tassels, Bottom Rail End Caps
005	White Gloss	205	005	White	005
006	Raw Umber	033	033	Black	006
062	Char Brown	062	062	Black	062
065	Almost White Gloss	112	112	White	112
112	Alabaster	112	112	White	112
121	Brushed Aluminum	034	026	Black	026
122	Greige	122	026	Black	122
126	Ash Metallic	126	126	Black	126
154	Hunter Green	154	154	Black	117
205	White Satin	205	005	White	005
233	Black Satin	233	033	Black	033
326	Alabaster Pearl	112	112	White	112
386	Snowcap White	386	005	White	005
544	True White	205	005	White	005
670	Creamy Beige	670	031	White	356
724	Almond	724	004	White	004
741	Polished Aluminum	034	026	Black	026
904	Lamplight	904	031	White	031
963	Stucco	963	026	White	963
983	Gray Haze	983	026	White	026

Ladder Color Coordination: Dual Headrail

The Graber® Skylight Blind uses a specially constructed ladder designed for the interlacing of slats. The five ladder colors offered will coordinate with many slat colors.

NOTE: You may request a different ladder color.

Interlacing Ladder Color	Slat Color Examples					
	Color Name	Color Number	Color Name	Color Number	Color Name	Color Number
Char Brown #062	Char Brown	062	Milk Chocolate	060	Tender Taupe	103
	Granite	044	Raw Umber	006		
Smokey Gray #026	Aluminum	034	Greige	122	Skyline	680
	Black Satin	233	Pitch Black	033	Smokey Gray	026
	Brushed Aluminum	121	Polished Aluminum	741	Stucco	963
	Gray Dawn	405	Rock Gray	399	UN Gray	095
	Gray Haze	983	Silver	737		
Fawn #031	Buff	624	Desert Sand	625	Lamplight	904
	Cameo	607	Fawn	031		
	Creamy Beige	670	Fawn Pearl	327		
White Gloss #005	Burgundy	653	Magnet	648	True Blue	089
	Coconut	630	Mercury	771	True White	544
	Crystal White	629	Midnight Blue	057	White Gloss	005
	Forest Shadow	087	Navajo White	376	White Satin	205
	Hunter Green	154	Real Red	085	White Pearl	637
	Ice	778	Snowcap White	386		
Alabaster #112	Alabaster	112	Ash Metallic	126	Flax	541
	Alabaster Pearl	326	Beige	011	Matte White	042
	Almond	724	Beige Pearl	328	Parchment	535
	Almost White Gloss	065	Birch White	375	Vanilla	100

General Information

Stack Height Chart

Finished Blind Height inches (cm)	Cordless Supreme inches (cm)	Cordless Supreme Hidden Holes™ inches (cm)	Classics and Supreme inches (cm)	Supreme Hidden Holes inches (cm)	Insignia® inches (cm)	Supreme ½" (1.3 cm) Micro inches (cm)	2" (5.1 cm) Grandeur™ inches (cm)
10 (25.4)			2 (5.1)	2 (5.1)	1 ³ / ₁₆ (4.7)	2 ¹ / ₁₆ (5.3)	3 ³ / ₈ (8.6)
15 (38.1)	2 ³ / ₁₆ (5.6)	2 ¹ / ₈ (5.4)	2 ¹ / ₁₆ (5.3)	2 ¹ / ₈ (5.4)	1 ¹ / ₈ (4.8)	2 ¹ / ₄ (5.8)	3 ¹ / ₂ (8.9)
20 (50.8)	2 ¹ / ₄ (5.8)	2 ¹ / ₄ (5.8)	2 ³ / ₁₆ (5.6)	2 ¹ / ₄ (5.8)	2 (5.1)	2 ⁷ / ₁₆ (6.2)	3 ⁵ / ₈ (9.3)
25 (63.5)	2 ³ / ₈ (6.1)	2 ³ / ₈ (6.1)	2 ¹ / ₄ (5.8)	2 ³ / ₈ (6.1)	2 ¹ / ₈ (5.4)	2 ¹¹ / ₁₆ (6.9)	3 ¹ / ₁₆ (9.4)
30 (76.2)	2 ⁷ / ₁₆ (6.2)	2 ¹ / ₂ (6.4)	2 ³ / ₈ (6.1)	2 ¹ / ₂ (6.4)	2 ³ / ₁₆ (5.6)	2 ¹ / ₂ (7.4)	3 ³ / ₁₆ (9.7)
35 (88.9)	2 ⁹ / ₁₆ (6.6)	2 ⁹ / ₁₆ (6.6)	2 ¹ / ₂ (6.4)	2 ¹¹ / ₁₆ (6.9)	2 ³ / ₈ (5.9)	3 ¹ / ₈ (8.0)	3 ¹⁵ / ₁₆ (10.1)
40 (101.6)	2 ¹¹ / ₁₆ (6.9)	2 ⁷ / ₁₆ (6.2)	2 ⁵ / ₈ (6.7)	2 ¹³ / ₁₆ (7.2)	2 ³ / ₈ (6.1)	3 ¹ / ₄ (8.3)	4 ¹ / ₁₆ (10.4)
45 (114.3)	2 ³ / ₄ (7.0)	2 ³ / ₄ (7.0)	2 ³ / ₄ (7.0)	2 ¹⁵ / ₁₆ (7.5)	2 ¹ / ₂ (6.4)	3 ⁷ / ₁₆ (8.8)	4 ³ / ₁₆ (10.7)
50 (127.0)	2 ⁷ / ₈ (7.4)	2 ⁷ / ₈ (7.4)	2 ⁷ / ₈ (7.4)	3 ¹ / ₈ (7.8)	2 ⁵ / ₈ (6.7)	3 ¹¹ / ₁₆ (9.4)	4 ⁵ / ₁₆ (11.0)
55 (139.7)	3 (7.7)	3 (7.7)	3 (7.7)	3 ¹ / ₄ (8.3)	2 ¹¹ / ₁₆ (6.9)	3 ³ / ₈ (9.9)	4 ³ / ₈ (11.2)
60 (152.4)	3 ¹ / ₁₆ (7.7)	3 ¹ / ₁₆ (7.8)	3 ¹ / ₈ (8.0)	3 ³ / ₈ (8.6)	2 ¹³ / ₁₆ (7.2)	4 ¹ / ₁₆ (10.4)	4 ¹ / ₂ (11.5)
65 (165.1)	3 ³ / ₁₆ (8.1)	3 ³ / ₁₆ (8.1)	3 ¹ / ₄ (8.3)	3 ¹ / ₂ (8.9)	2 ⁷ / ₈ (7.4)	4 ⁷ / ₁₆ (11.3)	4 ⁵ / ₈ (11.8)
70 (177.8)	3 ¹ / ₄ (8.3)	3 ¹ / ₄ (8.3)	3 ³ / ₈ (8.6)	3 ¹¹ / ₁₆ (9.4)	3 (7.7)	4 ¹ / ₂ (11.5)	4 ³ / ₄ (12.1)
75 (190.5)	3 ³ / ₈ (8.6)		3 ⁷ / ₁₆ (8.8)	3 ¹³ / ₁₆ (9.7)	3 ¹ / ₈ (8.0)	4 ¹¹ / ₁₆ (12.0)	4 ⁷ / ₈ (12.4)
80 (203.2)	3 ¹ / ₂ (8.9)		3 ⁹ / ₁₆ (9.1)	3 ¹⁵ / ₁₆ (10.1)	3 ³ / ₁₆ (8.1)	4 ³ / ₈ (12.4)	5 (12.7)
85 (215.9)			3 ¹¹ / ₁₆ (9.4)	4 ¹ / ₁₆ (10.4)	3 ⁵ / ₁₆ (8.5)	5 ¹ / ₁₆ (13.1)	5 ¹ / ₈ (13.1)
90 (228.6)			3 ¹³ / ₁₆ (9.7)	4 ¹ / ₄ (10.8)	3 ³ / ₈ (8.6)	5 ³ / ₁₆ (13.5)	5 ¹ / ₄ (13.4)
95 (241.3)			3 ¹⁵ / ₁₆ (10.1)	4 ³ / ₈ (11.2)	3 ¹ / ₂ (8.9)	5 ¹ / ₂ (14.0)	5 ³ / ₁₆ (13.2)
100 (254.0)			4 ¹ / ₁₆ (10.4)	4 ¹ / ₂ (11.5)	3 ⁵ / ₈ (9.3)	5 ¹¹ / ₁₆ (14.5)	5 ⁷ / ₁₆ (13.9)
105 (266.7)			4 ³ / ₁₆ (10.7)	4 ³ / ₈ (11.8)	3 ¹¹ / ₁₆ (9.4)	5 ¹ / ₈ (15.0)	5 ¹ / ₂ (14.2)
110 (279.4)			4 ⁵ / ₁₆ (11.0)	4 ¹³ / ₁₆ (12.3)	3 ¹³ / ₁₆ (9.7)	6 ¹ / ₁₆ (15.6)	5 ¹¹ / ₁₆ (14.5)
115 (292.1)			4 ³ / ₈ (11.2)	4 ¹⁵ / ₁₆ (12.6)	3 ⁷ / ₈ (9.9)	6 ³ / ₁₆ (16.1)	5 ¹³ / ₁₆ (14.8)
120 (304.8)			4 ¹ / ₂ (11.5)	5 ¹ / ₁₆ (12.9)	4 (10.2)	6 ¹ / ₂ (16.6)	5 ⁷ / ₈ (15.0)
125 (317.5)			4 ⁵ / ₈ (11.8)	5 ³ / ₁₆ (13.2)	4 ¹ / ₈ (10.5)		6 (15.3)

NOTE: Estimated finished blind heights include headrail and bottomrail.

General Information

Slat Count Chart

Finished Blind Height inches (cm)	Cordless Supreme	Cordless Supreme Hidden Holes™	Supreme	Supreme Hidden Holes	Supreme ½" (1.3 cm) Micro	2" (5.1 cm) Grandeur™	Insignia®	Classics
10 (25.4)			12	14	19	6	11	11
11 (28.0)			13	15	21	7	12	13
12 (30.5)	13	15	14	16	23	7	13	14
13 (33.1)	14	16	15	18	25	8	15	15
14 (35.6)	16	18	16	19	27	9	16	16
15 (38.1)	17	19	18	21	29	9	17	17
16 (40.7)	18	21	19	22	31	10	18	18
17 (43.2)	19	22	20	23	33	10	19	19
18 (45.8)	20	24	21	25	35	11	20	20
19 (48.3)	22	25	22	26	37	11	22	22
20 (50.8)	23	26	24	28	39	12	23	23
21 (53.4)	24	28	25	29	41	13	24	24
22 (55.9)	25	29	26	30	43	13	25	25
23 (58.5)	26	31	27	32	45	14	26	26
24 (61.0)	27	32	28	33	47	14	28	27
25 (63.5)	29	33	29	35	49	15	29	28
26 (66.1)	30	35	31	36	51	15	30	29
27 (68.6)	31	36	32	37	53	16	31	31
28 (71.2)	32	38	33	39	55	17	32	32
29 (73.7)	33	39	34	40	57	17	33	33
30 (76.2)	35	40	35	42	59	18	35	34
31 (78.8)	36	42	37	43	61	18	36	35
32 (81.3)	37	43	38	45	63	19	37	36
33 (83.9)	38	45	39	46	65	20	38	37
34 (86.4)	39	46	40	47	67	20	39	38
35 (88.9)	40	47	41	49	69	21	41	40
36 (91.5)	42	49	42	50	71	21	42	41
37 (94.0)	43	50	44	52	73	22	43	42
38 (96.6)	44	52	45	53	75	22	44	43
39 (99.1)	45	53	46	54	77	23	45	44
40 (101.6)	46	55	47	56	80	24	46	45
41 (104.2)	47	56	48	57	82	24	48	46
42 (106.7)	49	57	50	59	84	25	49	48
43 (109.3)	50	59	51	60	86	25	50	49
44 (111.8)	51	60	52	61	88	26	51	50
45 (114.3)	52	62	53	63	90	26	52	51
46 (116.9)	53	63	54	64	92	27	54	52
47 (119.4)	55	64	55	66	94	28	55	53
48 (122.0)	56	66	57	67	96	28	56	54
49 (124.5)	57	67	58	69	98	29	57	55
50 (127.0)	58	69	59	70	100	29	58	57
51 (129.6)	59	70	60	71	102	30	59	58
52 (132.1)	60	71	61	73	104	31	61	59
53 (134.7)	62	73	63	74	106	31	62	60
54 (137.2)	63	74	64	76	108	32	63	61
55 (139.7)	64	76	65	77	110	32	64	62
56 (142.3)	65	77	66	78	112	33	65	63
57 (144.8)	66	79	67	80	114	33	67	64
58 (147.4)	68	80	68	81	116	34	68	66
59 (149.9)	69	81	70	83	118	35	69	67
60 (152.4)	70	83	71	84	120	35	70	68
61 (155.0)	71	84	72	85	122	36	71	69
62 (157.5)	72	86	73	87	124	36	72	70
63 (160.1)	73	87	74	88	126	37	74	71
64 (162.6)	75	88	76	90	128	37	75	72
65 (165.1)	76	90	77	91	130	38	76	73
66 (167.7)	77	91	78	93	132	39	77	75
67 (170.2)	78	93	79	94	134	39	78	76
68 (172.8)	79	94	80	95	136	40	79	77
69 (175.3)	81	95	81	97	138	40	81	78
70 (177.8)	82	97	83	98	140	41	82	79
71 (180.4)	83	98	84	100	143	41	83	80
72 (182.9)	84	100	85	101	145	42	84	81
73 (185.5)	85		86	102	147	43	85	83
74 (188.0)	86		87	104	149	43	87	84
75 (190.5)	88		89	105	151	44	88	85
76 (193.1)	89		90	107	153	44	89	86
77 (195.6)	90		91	108	155	45	90	87
78 (198.2)	91		92	109	157	46	91	88
79 (200.7)	92		93	111	159	46	92	89
80 (203.2)	94		94	112	161	47	94	90

Finished Blind Height inches (cm)	Cordless Supreme	Cordless Supreme Hidden Holes™	Supreme	Supreme Hidden Holes	Supreme ½" (1.3 cm) Micro	2" (5.1 cm) Grandeur™	Insignia®	Classics
81 (205.8)	95		96	114	163	47	95	92
82 (208.3)	96		97	115	165	48	96	93
83 (210.9)	97		98	116	167	48	97	94
84 (213.4)	98		99	118	169	49	98	95
85 (215.9)			100	119	171	50	100	96
86 (218.5)			102	121	173	50	101	97
87 (221.0)			103	122	175	51	102	98
88 (223.6)			104	124	177	51	103	99
89 (226.1)			105	125	179	52	104	101
90 (228.6)			106	126	181	52	105	102
91 (231.2)			107	128	183	53	107	103
92 (233.7)			109	129	185	54	108	104
93 (236.3)			110	131	187	54	109	105
94 (238.8)			111	132	189	55	110	106
95 (241.3)			112	133	191	55	111	107
96 (243.9)			113	135	193	56	113	108
97 (246.4)			114	136	195	56	114	110
98 (249.0)			116	138	197	57	115	111
99 (251.5)			117	139	199	58	116	112
100 (254.0)			118	140	201	58	117	113
101 (256.6)			119	142	203	59	118	114
102 (259.1)			120	143	206	59	120	115
103 (261.7)			122	145	208	60	121	116
104 (264.2)			123	146	210	61	122	117
105 (266.7)			124	148	212	61	123	119
106 (269.3)			125	149	214	62	124	120
107 (271.8)			126	150	216	62	126	121
108 (274.4)			127	152	218	63	127	122
109 (276.9)			129	153		63	128	123
110 (279.4)			130	155		64	129	124
111 (282.0)			131	156		65	130	125
112 (284.5)			132	157		65	131	127
113 (287.1)			133	159		66	133	128
114 (289.6)			135	160		66	134	129
115 (292.1)			136	162		67	135	130
116 (297.7)			137	163		67	136	131
117 (297.2)			138	164		68	137	132
118 (299.8)			139	166		69	139	133
119 (302.3)			140	167		69	140	134
120 (304.8)			142	169		70	141	136
121 (307.4)			143	170		70	142	137
122 (309.9)			144	171		71	143	138
123 (312.5)			145	173		71	144	139
124 (315.0)			146	174		72	146	140
125 (317.5)			148	176		73	147	141
126 (320.1)			149	177		73	148	142
127 (322.6)			150	179		74	149	
128 (325.2)			151	180		74	150	
129 (327.7)			152	181		75	152	
130 (330.2)			153	183		76	153	
131 (332.8)			155	184		76	154	
132 (335.3)			156	186		77	155	
133 (337.9)			157	187		77	156	
134 (340.4)			158	188		78	157	
135 (342.9)			159	190		78	159	
136 (345.5)			161	191		79	160	
137 (348.0)			162	193		80	161	
138 (350.6)			163	194		80	162	
139 (353.1)			164	195		81	163	
140 (355.6)			165	197		81	165	
141 (358.2)			166	198		82	166	
142 (360.7)			168	200		82	167	
143 (363.3)			169	201		83	168	
144 (365.8)			170	203		84	169	
145 (368.3)			171	204		84	170	
146 (370.9)			172	205		85	172	
147 (373.4)			174	207		85	173	
148 (376.0)			175	208		86	174	
149 (378.5)			176	210		87	175	
150 (381.0)			177	211		87	176	

General Information

Slat Route and Ladder Count

Cordless Supreme

For Standard or Reverse Controls

Finished Blind Width inches (cm)	Slat End Route inches (cm)	# of Ladders	# of Lifts	# of Center Brackets
16 (40.7) to 17 ¹⁵ / ₁₆ (45.6)	5 ¹ / ₂ (14.0)	2	2	2
18 (45.8) to 20 ¹⁵ / ₁₆ (53.2)	6 (15.3)	2	2	2
21 (53.4) to 37 (94.0)	6 ¹ / ₂ (16.6)	2	2	2
37 (94.0) to 61 (155.0)	6 ¹ / ₂ (16.6)	3	2	2, 3 over 42" (106.7 cm)
61 (155.0) to 85 (215.9)	6 ¹ / ₂ (16.6)	4	4	3, 4 over 72" (182.9 cm)
85 (215.9) to 109 (276.9)	6 ¹ / ₂ (16.6)	5	4	4, 5 over 102" (259.1 cm)

NOTES:

1. Maximum spacing between ladders is 24" (61.0 cm).
2. Standard control position: tilt left.

Supreme with Side Mount Brackets

For Standard or Reverse Controls

Finished Blind Width inches (cm)	Slat End Route inches (cm)	# of Ladders	# of Lifts
7 ¹ / ₂ (19.1) to 8 ¹⁵ / ₁₆ (22.8)	2 (5.1)	2	2
9 (22.9) to 11 ¹⁵ / ₁₆ (30.4)	3 (7.7)	2	2
12 (30.5) to 20 ¹⁵ / ₁₆ (53.2)	4 (10.2)	2	2
21 (53.4) to 37 (94.0)	6 ¹ / ₂ (16.6)	2	2
37 ¹ / ₁₆ (94.2) to 60 (152.4)	6 ¹ / ₂ (16.6)	3	2

For Same Side Controls

12 (30.5) to 20 ¹⁵ / ₁₆ (53.2)	4 (10.2)	As above	As above
21 (53.4) to 60 (152.4)	6 ¹ / ₂ (16.6)	As above	As above

NOTES:

1. Maximum spacing between ladders is 24" (61.0 cm).
2. Standard control positions: lift right/tilt left.
3. Maximum spacing for using side mount brackets is 60" (152.4 cm).

Supreme

Standard and Hidden Holes™ Option

Finished Blind Width inches (cm)	Slat End Route inches (cm)	# of Ladders	# of Lifts	# of Center Brackets
5 ¹ / ₂ (14.0) to 6 ¹⁵ / ₁₆ (17.7)	1 ¹ / ₂ (3.9)	2	2	2
7 (17.8) to 8 ¹⁵ / ₁₆ (22.8)	2 (5.1)	2	2	2
9 (22.9) to 11 ¹⁵ / ₁₆ (30.4)	3 (7.7)	2	2	2
12 (30.5) to 20 ¹⁵ / ₁₆ (53.2)	4 (10.2)	2	2	2
21 (53.4) to 37 (94.0)	6 ¹ / ₂ (16.6)	2	2	2
37 ¹ / ₁₆ (94.2) to 61 (155.0)	6 ¹ / ₂ (16.6)	3	2	2, 3 over 60" (152.4 cm) FBW
61 ¹ / ₁₆ (155.1) to 85 (215.9)	6 ¹ / ₂ (16.6)	4	4	3, 4 over 96" (243.9 cm) FBW
85 ¹ / ₁₆ (216.1) to 109 (276.9)	6 ¹ / ₂ (16.6)	5	4	4
109 ¹ / ₁₆ (277.1) to 133 (337.9)	6 ¹ / ₂ (16.6)	6	4	4
133 ¹ / ₁₆ (338.0) to 142 (360.7)	6 ¹ / ₂ (16.6)	7	4	4

For Same Side Controls

11 ¹⁵ / ₁₆ (30.4) to 20 ¹⁵ / ₁₆ (53.2)	4 (10.2)	As above	As above	As above
21 (53.4) to 142 ¹⁵ / ₁₆ (360.7)	6 ¹ / ₂ (16.6)	As above	As above	As above

NOTES:

1. Maximum spacing between ladders is 24" (61.0 cm).
2. Standard control positions: lift right/tilt left.
3. Maximum slat width is 142" (360.7 cm). Wider blinds must be multiple stack.

Classics

For Standard or Reverse Controls

Finished Blind Width inches (cm)	Slat End Route inches (cm)	# of Ladders	# of Lifts	# of Center Brackets
5 ¹ / ₂ (14.0) to 6 ¹⁵ / ₁₆ (17.7)	1 ¹ / ₁₆ (4.3)	2	2	0
7 (17.8) to 8 ¹⁵ / ₁₆ (22.8)	2 (5.1)	2	2	0
9 (22.9) to 11 ¹⁵ / ₁₆ (30.4)	3 ³ / ₄ (8.3)	2	2	0
12 (30.5) to 20 ¹⁵ / ₁₆ (50.8)	4 (10.2)	2	2	0
21 (53.4) to 37 (94.0)	6 ¹ / ₂ (16.6)	2	2	0
37 ¹ / ₁₆ (94.2) to 61 (155.0)	6 ¹ / ₂ (16.6)	3	2	1 over 60" (152.4 cm) FBW
61 ¹ / ₁₆ (155.1) to 85 (215.9)	6 ¹ / ₂ (16.6)	4	4	1
85 ¹ / ₁₆ (216.1) to 109 (276.9)	6 ¹ / ₂ (16.6)	5	4	2 over 96" (243.9 cm) FBW
109 ¹ / ₁₆ (277.1) to 133 (337.9)	6 ¹ / ₂ (16.6)	6	4	2
133 ¹ / ₁₆ (338.0) to 143 ³ / ₄ (365.2)	6 ¹ / ₂ (16.6)	7	4	2

For Same Side Controls

11 ¹⁵ / ₁₆ (30.4) to 20 ¹⁵ / ₁₆ (53.2)	4 (10.2)	As above	As above	As above
21 (53.4) to 142 ¹⁵ / ₁₆ (360.7)	6 ¹ / ₂ (16.6)	As above	As above	As above

NOTES:

1. Maximum spacing between ladders is 24" (61.0 cm).
2. Standard control position: lift right/tilt left.

General Information

Slat Route and Ladder Count

Insignia®

For Standard or Reverse Controls

Finished Blind Width inches (cm)	Slat End Route inches (cm)	# of Ladders	# of Lifts	# of Center Brackets
5½ (14.0) to 8 ¹⁵ / ₁₆ (22.8)	1½ (3.9)	2	2	0
9 (22.9) to 11 ¹⁵ / ₁₆ (30.4)	3 (7.7)	2	2	0
12 (30.5) to 20 ¹⁵ / ₁₆ (53.2)	4 (10.2)	2	2	0
21 (53.4) to 37 (94.0)	6½ (16.6)	2	2	0
37 ¹ / ₁₆ (94.2) to 61 (155.0)	6½ (16.6)	3	2	1 over 48" (122.0 cm) FBW
61 ¹ / ₁₆ (155.1) to 85 (215.9)	6½ (16.6)	4	4	1
85 ¹ / ₁₆ (216.1) to 109 (279.9)	6½ (16.6)	5	4	2 over 96" (243.9 cm) FBW
109 ¹ / ₁₆ (277.1) to 120 (304.8)	6½ (16.6)	6	4	2

For Same Side Controls

11 ¹⁵ / ₁₆ (30.4) to 20 ¹⁵ / ₁₆ (53.2)	4 (10.2)	As above	As above	As above
21 (53.4) to 120 (304.8)	6½ (16.6)	As above	As above	As above

NOTES:

1. Maximum spacing between ladders is 24" (61.0 cm).
2. Standard control positions: lift right/tilt left.

Micro Supreme with Side Mount Brackets

For Standard or Reverse Controls

Finished Blind Width inches (cm)	Slat End Route inches (cm)	# of Ladders	# of Lifts
7½ (19.1) to 8 ¹⁵ / ₁₆ (22.8)	2 (5.1)	2	2
9 (22.9) to 11 ¹⁵ / ₁₆ (30.4)	3 (7.7)	2	2
12 (30.5) to 22 (55.9)	4 (10.2)	2	2
22 ¹ / ₁₆ (56.1) to 36 (91.5)	4 (10.2)	3	2
36 ¹ / ₁₆ (91.6) to 50 (127.0)	4 (10.2)	4	2
50 ¹ / ₁₆ (127.2) to 60 (152.4)	4 (10.2)	5	4

For Same Side Controls

12 (30.5) to 22 (55.9)	4 (10.2)	2	2
22 ¹ / ₁₆ (56.1) to 36 (91.5)	4 (10.2)	3	2
36 ¹ / ₁₆ (91.6) to 50 (127.0)	4 (10.2)	4	2
50 ¹ / ₁₆ (127.2) to 60 (152.4)	4 (10.2)	5	4

NOTES:

1. Maximum spacing between ladders is 14" (35.6 cm).
2. Standard control positions: lift right/tilt left.
3. Maximum FBW for side mount brackets is 60" (152.4 cm).

Micro Supreme

For Standard or Reverse Controls

Finished Blind Width inches (cm)	Slat End Route inches (cm)	# of Ladders	# of Lifts	# of Center Brackets
5½ (14.0) to 6 ¹⁵ / ₁₆ (17.7)	1½ (3.9)	2	2	2
7 (17.8) to 8 ¹⁵ / ₁₆ (22.8)	2 (5.1)	2	2	2
9 (22.9) to 11 ¹⁵ / ₁₆ (30.4)	3 (7.7)	2	2	2
12 (30.5) to 22 (55.9)	4 (10.2)	2	2	2
22 ¹ / ₁₆ (56.1) to 36 (91.5)	4 (10.2)	3	2	2
36 ¹ / ₁₆ (91.6) to 50 (127.0)	4 (10.2)	4	2	2
50 ¹ / ₁₆ (127.2) to 64 (162.6)	4 (10.2)	5	4	3 over 60" (152.4 cm) FBW
64 ¹ / ₁₆ (162.8) to 78 (198.2)	4 (10.2)	6	4	3
78 ¹ / ₁₆ (198.3) to 92 (233.7)	4 (10.2)	7	4	4
92 ¹ / ₁₆ (233.9) to 106 (269.3)	4 (10.2)	8	4	4
106 ¹ / ₁₆ (269.4) to 120 (304.8)	4 (10.2)	9	4	4

For Same Side Controls

12 (30.5) to 120 (304.8)	4 (10.2)	As above	As above	As above
--------------------------	----------	-------------	-------------	----------

NOTES:

1. Maximum spacing between ladders is 14" (35.6 cm).
2. Standard blinds: standard control positions: lift right/tilt left.

Grandeur™ 2" (5.1 cm) Aluminum

For Standard or Reverse Controls

Finished Blind Width inches (cm)	Slat End Route inches (cm)	# of Ladders	# of Lifts	# of Center Brackets
9 (22.9) to 10 (25.4) on cord tilt only	2½ (6.1)	2	2	0
9 (22.9) to 11 ¹⁵ / ₁₆ (30.4)	2½ (6.1)	2	2	0
12 (30.5) to 24 (61.0)	4 (10.2)	2	2	0
24 ¹ / ₁₆ (61.2) to 36 (91.5)	6 (15.3)	2	2	0
36 ¹ / ₁₆ (91.6) to 60 (152.4)	6 (15.3)	3	2	1 over 48" (122.0 cm) FBW
60 ¹ / ₁₆ (152.6) to 84 (213.4)	6 (15.3)	4	4	2 over 72" (182.9 cm) FBW
84 ¹ / ₁₆ (213.6) to 108 (274.4)	6 (15.3)	5	4	2
108 ¹ / ₁₆ (274.5) to 132 (335.3)	6 (15.3)	6	4	3
132 ¹ / ₁₆ (335.5) to 142 (360.7)	6 (15.3)	7	4	4

For Same Side Controls

16 ¹ / ₁₆ (40.8) to 36 (91.5)	6 (15.3)	2	2	0
36 ¹ / ₁₆ (91.6) to 60 (152.4)	6 (15.3)	3	2	1 over 48" (122.0 cm) FBW
60 ¹ / ₁₆ (152.6) to 84 (213.4)	6 (15.3)	4	4	2 over 72" (182.9 cm) FBW
84 ¹ / ₁₆ (213.6) to 108 (274.4)	6 (15.3)	5	4	2
108 ¹ / ₁₆ (274.5) to 132 (335.3)	6 (15.3)	6	4	3
132 ¹ / ₁₆ (335.5) to 142 (360.7)	6 (15.3)	7	4	4

NOTES:

1. Maximum spacing between ladders is 24" (61.0 cm).
2. Standard control position: lift right/tilt left.
3. Maximum headrail width for multiple stack blinds is 142" (360.7 cm). Maximum slat width is 142" (360.7 cm).

General Information

1/2" (1.3 cm) Micro Supreme and 1" (2.6 cm) Supreme Product Detail

Projection Brackets (optional)

- Available in 3/8" (1.0 cm), 1 1/4" (4.5 cm), 2 3/4" (7.0 cm), and 4 3/4" (12.1 cm) sizes
- Outside mount only

Hidden Headrail Brackets

- Stable, easy to install
- Reduces light gap

No Valance Headrail

- Cleaner, smoother appearance
- Light-blocking lip eliminates light gap between headrail and top slat

Color Coordinated End Caps

- Provide a custom finished look

Side Mount Brackets (optional)

Clutch Wand Tilt

- Releases to prevent tilt damage

Bottomrail Bumper Pads

- Provide cushioning and prevent blind from rattling and scratching window sill
- Not available on Micro Supreme

Precision Rollers

- Require less effort to raise blinds

Crash-Proof Cord Lock

- Prevents blind and/or sill damage

Tighter Ladder Spacing

- More slats per foot for greater light-blocking ability

Hold Down Brackets (optional)

- Secure blind to wall, door, or window sill

General Information

1" (2.6 cm) Cordless Supreme Product Detail

Cordless lift blinds are the safest window blind alternative; ideal for homes with children and pets. Elimination of lift cords and cord loops provides a more attractive appearance.

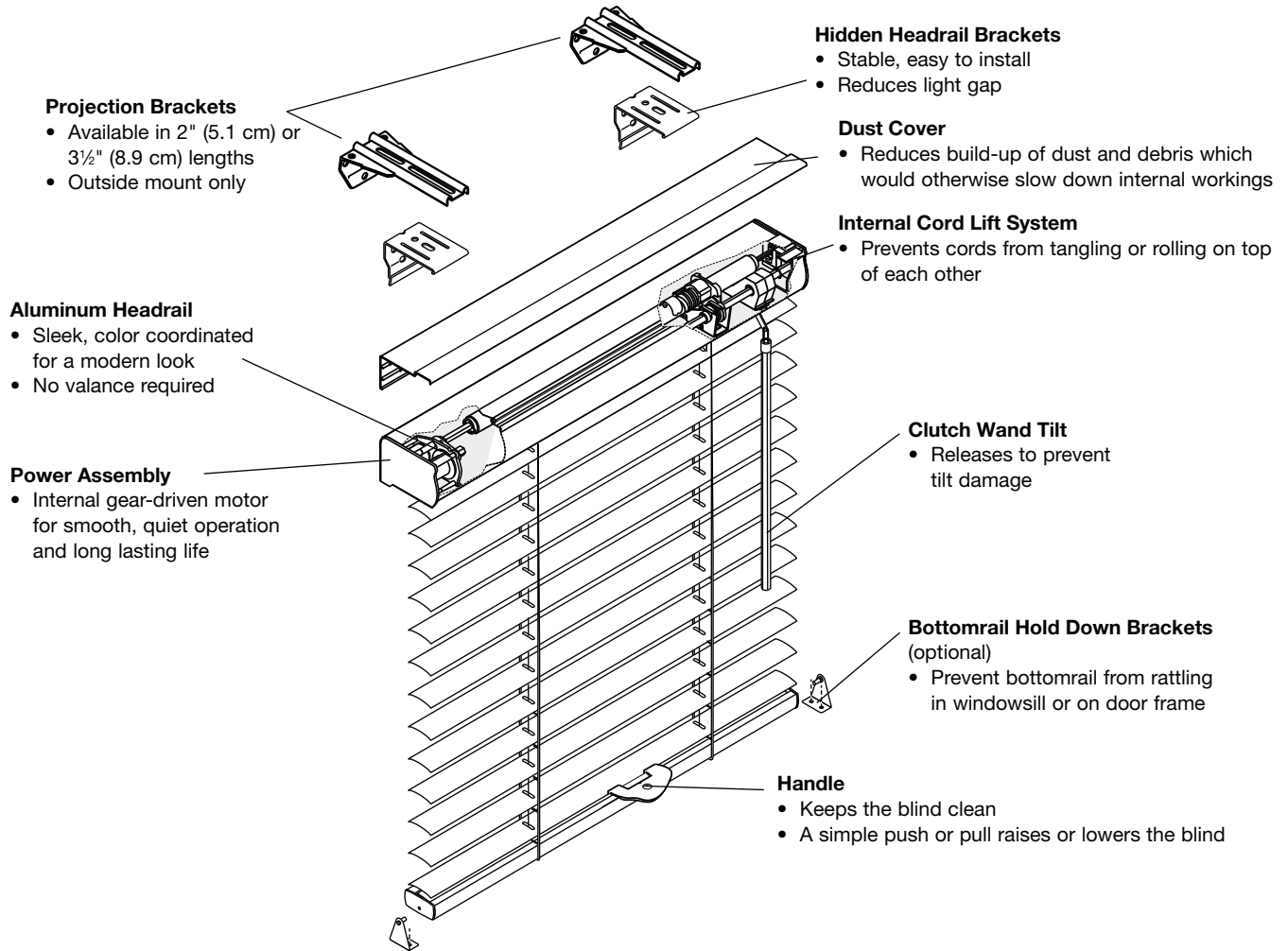

General Information

1" (2.6 cm) Classics Product Detail

Projection Brackets

- Available in short 1¾" (4.4 cm), medium 2¾" (7.0 cm), or long 4¾" (12.1 cm) lengths
- Outside mount only

Box Brackets

- Make it a snap to install

Crash-Proof Cordlock

- Prevent sill damage

Two-Slat Valance

- Provides a more finished look

Clutch Wand Tilt

- Automatically releases to prevent damage when over rotated

Bottomrail Bumper Pads

- Prevent sill damage

Hold Down Brackets (optional)

- Secures blind to wall, door, or window sill

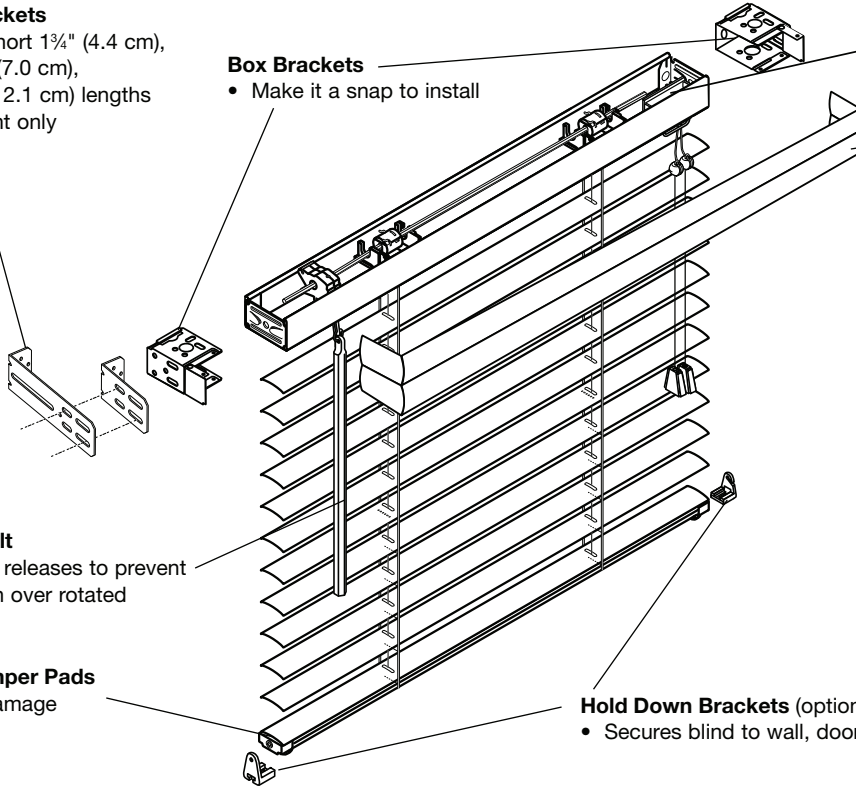

General Information

1" (2.6 cm) Insignia® Product Detail

Projection Brackets

- Available in short 1¾" (4.4 cm), medium 2¾" (7.0 cm), or long 4¾" (12.1 cm) lengths
- Outside mount only

Box Brackets

- Make it a snap to install

Crash-Proof Cordlock

- Prevent sill damage

Two-Slat Valance

- Provides a more finished look

Clutch Wand Tilt

- Automatically releases to prevent damage when over rotated

Hold Down Brackets (optional)

- Secures blind to wall, door, or window sill

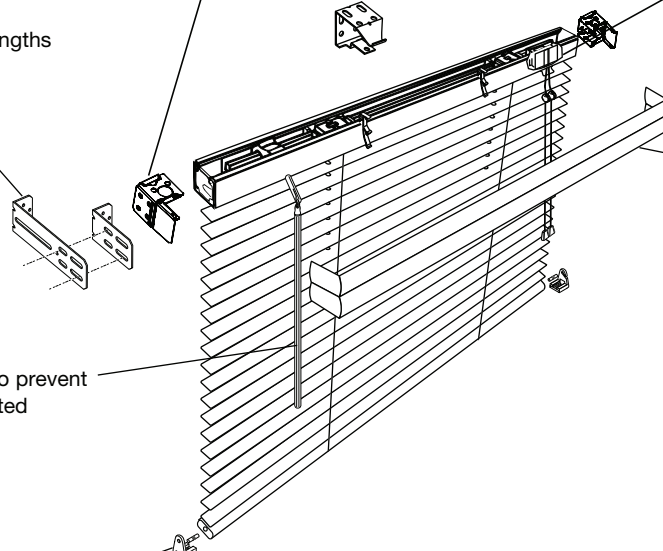

2" (5.1 cm) Grandeur™ Product Detail

Patented SureClose™ Headrail

- Provides tightest closure for superior privacy and light control
- Light-blocking lip eliminates light gap between headrail and top slat
- Lower profile is less obtrusive

Mounting Brackets

- Designed for easy installation

Crash-Proof Cordlock

- Prevents blind and/or sill damage

Deluxe Channel Panel Valance

- Provides a sleek, finished appearance
- Standard valance return size is 3½" (8.0 cm)

Projection Brackets

- Available in medium 2¾" (7.0 cm) or long 4¾" (12.1 cm) lengths
- Outside mount only

Color Coordinated Cord Tilt

- Precision engineered for durability
- Wand tilt also available

.008 Gauge Dust-Repellent Slats

- Manufactured from heavy-duty aluminum
- Harder surface is less porous and more stain and scratch resistant

Hold Down Brackets (optional)

- Secures blind to wall, door, or window sill

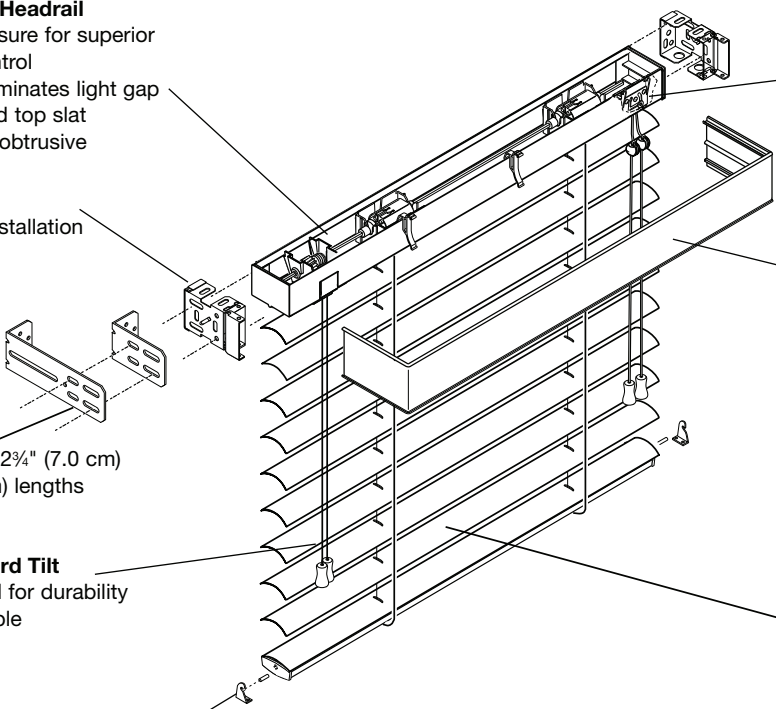

Price Charts

Price Group A: 1" (2.6 cm) Cordless Supreme

1" (2.6 cm) Slats .006 Gauge

Height up to inches (cm) ↓	Width up to inches (cm) →																			
	23 (58.5)	26 (66.1)	29 (73.7)	32 (81.3)	36 (91.5)	40 (101.6)	44 (111.8)	48 (122.0)	52 (132.1)	57 (144.8)	62 (157.5)	67 (170.2)	72 (182.9)	82 (208.3)	92 (233.7)	102 (259.1)	112 (284.5)	122 (309.9)	132 (335.3)	144 (365.8)
42 (106.7)	\$167	173	178	194	201	215	230	241	253	271	281	299	314	372	400	439	465	496	560	585
48 (122.0)	171	177	192	201	214	225	240	254	267	287	301	318	332	392	428	463	491	528	591	623
54 (137.2)	175	191	198	206	222	236	250	265	276	304	320	333	354	414	451	488	523	557	623	658
60 (152.4)	187	197	202	220	233	245	262	276	290	319	333	354	368	434	470	517	551	587	655	691
66 (167.7)	192	201	217	230	240	258	271	288	310	331	349	365	389	454	490	543	577	618	691	730
72 (182.9)	197	210	223	234	253	267	284	307	320	347	365	385	411	475	519	566	607	653	722	763
78 (198.2)	206	217	230	240	261	277	298	319	332	360	382	407	426	501						
84 (213.4)	215	225	236	253	272	288	312	326	347	381	401	422	442							

Surcharge: Hidden Holes™

Hidden Holes Surcharge	\$8	8	8	9	11	12	12	13	13	16	16	17	19	23	24	29	30	33	36	37

Hidden Holes only available in sizes above the heavy line.

Maximum Size: Cordless lift: 6,400 square inches (4.2 m²)

Cordless lift with Hidden Holes:

5,900 square inches (3.8 m²)

Multiple Blinds on One Headrail:

Blinds less than 96" (243.9 cm): add surcharge: \$44 two on one headrail

\$44 three on one headrail

Blind widths 96" (243.9 cm) to 144" (365.8 cm): no charge

1" (2.6 cm) Slats .008 Gauge

Height up to inches (cm) ↓	Width up to inches (cm) →																			
	23 (58.5)	26 (66.1)	29 (73.7)	32 (81.3)	36 (91.5)	40 (101.6)	44 (111.8)	48 (122.0)	52 (132.1)	57 (144.8)	62 (157.5)	67 (170.2)	72 (182.9)	82 (208.3)	92 (233.7)	102 (259.1)	112 (284.5)	122 (309.9)	132 (335.3)	144 (365.8)
42 (106.7)	\$175	178	187	205	212	225	245	257	267	285	299	318	332	392	425	465	495	528	595	618
48 (122.0)	176	186	202	212	225	239	255	268	282	307	320	337	354	419	454	492	523	561	629	661
54 (137.2)	183	201	209	216	236	251	263	280	290	322	340	356	377	438	481	522	555	594	663	702
60 (152.4)	199	208	213	233	247	259	278	290	311	339	356	377	392	462	500	550	588	628	700	736
66 (167.7)	202	212	230	244	257	273	286	308	326	354	374	389	418	483	525	581	615	664	738	779
72 (182.9)	207	220	236	249	269	282	304	324	340	372	389	412	439	506	553	606	651	701	773	815
78 (198.2)	216	232	244	257	278	293	317	339	355	384	409	435	454	536						
84 (213.4)	226	237	253	269	288	311	331	348	373	407	429	449	475							

Surcharge: Hidden Holes

Hidden Holes Surcharge	\$8	8	8	9	11	12	12	13	13	16	16	17	19	23	24	29	30	33	36	37

Hidden Holes only available in sizes above the heavy line.

Maximum Size: Cordless lift: 6,400 square inches (4.2 m²)

Cordless lift with Hidden Holes:

5,900 square inches (3.8 m²)

Multiple Blinds on One Headrail:

Blinds less than 96" (243.9 cm): add surcharge: \$44 two on one headrail

\$44 three on one headrail

Blind widths 96" (243.9 cm) to 144" (365.8 cm): no charge

Colors

Alabaster	112	Coconut.	630	Milk Chocolate	060	Premium Colors
Almost White Gloss.	065	Crystal White.	629	Princess Pink.	023	(10% Surcharge)
Aluminum	034	Desert Sand.	625	Real Red	085	Alabaster Pearl
Beige.	011	Fawn	031	Snowcap White.	386	Beige Pearl
Black Satin	233	Flax	541	True Blue	089	Brushed Aluminum
Burgundy.	653	Hunter Green.	154	True White	544	Fawn Pearl.
Cameo.	607	Lamplight.	904	Vanilla	100	Polished Aluminum
Canary Yellow	009	Lavender Lace.	024			White Pearl
Char Brown	062	Little Boy Blue.	090			

Price Charts

Price Group B: 1" (2.6 cm) Supreme

1" (2.6 cm) Slats .006 Gauge

Height up to inches (cm) ↓	Width up to inches (cm) →																									
	12 (30.5)	23 (58.5)	26 (66.1)	29 (73.7)	32 (81.3)	36 (91.5)	40 (101.6)	44 (111.8)	48 (122.0)	52 (132.1)	57 (144.8)	62 (157.5)	67 (170.2)	72 (182.9)	82 (208.3)	92 (233.7)	102 (259.1)	112 (284.5)	122 (309.9)	132 (335.3)	142 (360.7)	152 (386.1)	162 (411.5)	172 (436.9)	182 (462.3)	192 (487.7)
42 (106.7)	\$102	83	86	94	105	112	123	137	144	154	171	180	195	206	232	257	293	314	342	371	390	418	445	473	499	528
48 (122.0)	105	86	94	107	112	125	137	148	157	169	190	199	216	227	257	287	317	342	375	406	430	463	496	530	563	597
54 (137.2)	111	94	107	112	117	137	148	157	169	178	206	223	232	250	279	311	345	375	409	437	471	505	540	573	607	607
60 (152.4)	123	107	112	117	136	148	157	171	180	195	223	235	254	265	301	332	375	409	441	474	505	543	581	618	656	694
66 (167.7)	126	110	117	136	144	157	171	180	195	215	235	254	266	289	323	354	406	435	475	512	547	586	625	664	703	742
72 (182.9)	131	114	125	141	151	169	180	195	215	227	254	270	289	311	345	384	430	471	512	547	584	626	668	711	754	796
78 (198.2)	142	123	137	148	157	178	191	210	227	239	266	289	311	330	374	409	461	497	544	584	622	665	709	753	796	841
84 (213.4)	153	136	144	157	169	190	206	224	235	257	289	310	330	345	395	431	488	533	581	618	658	705	753	800	847	894
90 (228.6)	158	141	154	165	178	199	223	232	254	266	301	323	342	371	414	461	512	561	608	656	702	753	803	853	904	955
96 (243.9)	164	148	157	171	182	215	229	250	265	287	317	339	368	386	435	484	544	588	646	693	736	788	840	889	941	993
102 (259.1)	171	154	169	180	195	223	239	259	279	299	336	357	384	409	461	510	572	622	677	727	779	835	889	944	1001	1056
108 (274.4)	179	161	176	190	206	229	254	270	293	314	348	375	406	426	484	536	602	651	710	763	818	876	931	988	1043	1100
114 (289.6)	186	169	180	199	216	239	261	287	310	330	371	395	423	448	505	561	628	679	748	814	883	944	1007	1070	1131	1193
120 (304.8)	188	171	190	210	227	254	270	299	320	342	384	409	437	471	533	585	656	716	774	831	889	953	1014	1076	1138	1199
126 (320.1)	195	178	199	223	232	261	289	311	332	354	400	430	461	488	551	608	684	744	803	863	919	983	1046	1112	1177	1239

Surcharge: Hidden Holes™

Hidden Holes Surcharge	\$8	8	8	8	9	11	12	12	13	13	16	16	17	19	23	24	29	30	33	36	37	40	43	46	49	52
------------------------	-----	---	---	---	---	----	----	----	----	----	----	----	----	----	----	----	----	----	----	----	----	----	----	----	----	----

NOTE: Smallest width available 5½" (14.0 cm) exact.
Widths from 5½" (14.0 cm) to 8⅜" (22.8 cm) are center tilt only.

Multiple Blinds on One Headrail:
Blinds less than 142" (360.7 cm): add surcharge: \$44 two on one headrail
\$44 three on one headrail
Blind widths 142" (360.7 cm) to 192" (487.7 cm): no charge

1" (2.6 cm) Slats .008 Gauge

Height up to inches (cm) ↓	Width up to inches (cm) →																									
	12 (30.5)	23 (58.5)	26 (66.1)	29 (73.7)	32 (81.3)	36 (91.5)	40 (101.6)	44 (111.8)	48 (122.0)	52 (132.1)	57 (144.8)	62 (157.5)	67 (170.2)	72 (182.9)	82 (208.3)	92 (233.7)	102 (259.1)	112 (284.5)	122 (309.9)	132 (335.3)	142 (360.7)	152 (386.1)	162 (411.5)	172 (436.9)	182 (462.3)	192 (487.7)
42 (106.7)	\$110	92	95	104	116	123	137	153	159	169	187	197	216	227	257	283	320	347	375	409	426	460	493	527	560	594
48 (122.0)	112	95	104	117	123	140	153	162	173	186	210	223	235	250	283	314	349	375	413	445	474	510	547	584	620	657
54 (137.2)	120	104	117	123	127	153	162	173	186	195	227	245	257	275	305	342	381	413	448	482	518	555	594	632	668	706
60 (152.4)	136	117	123	127	148	162	173	187	197	216	245	260	280	293	332	366	413	448	483	523	552	595	636	677	718	759
66 (167.7)	139	120	127	148	159	173	187	197	216	233	260	280	294	317	355	390	445	479	525	563	602	644	688	730	772	814
72 (182.9)	143	124	140	157	163	186	197	216	233	250	280	298	317	342	381	422	474	518	563	602	641	689	736	781	829	877
78 (198.2)	154	137	153	162	173	195	212	229	250	264	294	317	342	359	412	448	508	547	599	641	684	732	779	828	877	924
84 (213.4)	164	148	159	173	186	210	227	246	260	283	317	340	359	381	435	475	536	586	638	682	724	775	827	879	930	982
90 (228.6)	175	157	169	181	195	223	245	257	280	294	332	355	375	409	456	508	563	617	671	722	772	827	882	937	992	1046
96 (243.9)	180	162	173	187	199	233	252	275	293	314	349	372	406	425	479	533	599	647	710	762	810	866	922	978	1035	1091
102 (259.1)	186	169	186	197	216	245	264	284	305	331	370	392	422	448	508	561	632	684	743	800	859	919	978	1038	1098	1156
108 (274.4)	194	177	193	210	227	252	280	298	320	347	384	413	445	471	533	589	663	716	779	841	901	962	1025	1085	1148	1211
114 (289.6)	202	186	197	223	235	264	288	314	340	359	409	435	466	492	552	617	690	748	823	896	971	1040	1110	1179	1248	1314
120 (304.8)	206	187	210	229	250	280	298	331	354	375	422	448	482	518	586	642	722	789	851	916	978	1046	1116	1185	1254	1323
126 (320.1)	214	195	223	245	257	288	317	342	366	390	441	474	508	536	606	671	754	818	883	950	1010	1080	1150	1221	1291	1361

Surcharge: Hidden Holes

Hidden Holes Surcharge	\$8	8	8	8	9	11	12	12	13	13	16	16	17	19	23	24	29	30	33	36	37	40	43	46	49	52
------------------------	-----	---	---	---	---	----	----	----	----	----	----	----	----	----	----	----	----	----	----	----	----	----	----	----	----	----

NOTE: Smallest width available 5½" (14.0 cm) exact.
Widths from 5½" (14.0 cm) to 8⅜" (22.8 cm) are center tilt only.

Multiple Blinds on One Headrail:
Blinds less than 142" (360.7 cm): add surcharge: \$44 two on one headrail
\$44 three on one headrail
Blind widths 142" (360.7 cm) to 192" (487.7 cm): no charge

Colors

Alabaster	112	Flax	541	Parchment	535	Premium Colors	
Almond	724	Forest Shadow	087	Pitch Black	033	(10% Surcharge)	
Almost White Gloss	065	Granite	044	Princess Pink	023	Alabaster Pearl	326
Aluminum	034	Gray Dawn	405	Raw Umber	006	Ash Metallic	126
Beige	011	Gray Haze	983	Real Red	085	Beige Pearl	328
Birch White	375	Greige	122	Rock Gray	399	Brushed Aluminum	121
Black Satin	233	Hunter Green	154	Silver	737	Fawn Pearl	327
Buff	624	Ice	778	Skyline	680	Polished Aluminum	741
Burgundy	653	Lamplight	904	Smokey Gray	026	White Pearl	637
Cameo	607	Lavender Lace	024	Snowcap White	386		
Canary Yellow	009	Little Boy Blue	090	Stucco	963		
Char Brown	062	Magnet	648	Tender Taupe	103		
Coconut	630	Matte White	042	True Blue	089		
Creamy Beige	670	Mercury	771	True White	544		
Crystal White	629	Midnight Blue	057	U.N. Gray	095		
Desert Sand	625	Milk Chocolate	060	Vanilla	100		
Fawn	031	Navajo White	376	White Gloss	005		
				White Satin	205		

Price Charts

Price Group C: 1" (2.6 cm) Classics

1" (2.6 cm) Slats .006 Gauge

Height up to inches (cm)	Width up to inches (cm)																									
	12 (30.5)	23 (58.5)	26 (66.1)	29 (73.7)	32 (81.3)	36 (91.5)	40 (101.6)	44 (111.8)	48 (122.0)	52 (132.1)	57 (144.8)	62 (157.5)	67 (170.2)	72 (182.9)	82 (208.3)	92 (233.7)	102 (259.1)	112 (284.5)	122 (309.9)	132 (335.3)	142 (360.7)	152 (386.1)	162 (411.5)	172 (436.9)	182 (462.3)	192 (487.7)
42 (106.7)	\$101	82	86	93	104	111	122	134	143	153	169	178	194	204	230	254	289	312	339	368	386	414	441	467	495	526
48 (122.0)	104	86	93	106	111	124	134	147	156	166	187	198	214	225	254	284	314	339	372	401	426	458	492	526	558	589
54 (137.2)	110	93	106	111	116	134	147	156	166	176	204	220	230	247	276	308	341	372	404	432	465	499	534	568	602	635
60 (152.4)	122	106	111	116	133	147	156	169	178	194	220	233	252	263	298	329	372	404	437	470	499	537	575	612	650	685
66 (167.7)	125	109	116	133	143	156	169	178	194	213	233	252	264	286	320	349	401	430	471	507	542	581	618	657	696	734
72 (182.9)	129	113	124	140	149	166	178	194	213	225	252	268	286	308	341	381	426	465	507	542	578	619	661	705	747	788
78 (198.2)	141	122	134	147	156	176	188	208	225	236	264	286	308	326	371	404	456	493	538	578	615	658	703	746	789	829
84 (213.4)	152	133	143	156	166	187	204	222	233	254	286	307	326	341	391	427	483	529	575	612	652	699	746	792	838	883
90 (228.6)	157	140	153	164	176	198	220	230	252	264	298	320	339	368	410	456	507	555	603	650	695	746	795	845	896	943
96 (243.9)	163	147	156	169	180	213	227	247	263	284	314	336	365	383	430	480	538	583	640	686	727	779	830	881	933	983
102 (259.1)	169	153	166	178	194	220	236	257	276	295	333	353	381	404	456	505	566	615	670	720	772	827	881	936	990	1045
108 (274.4)	177	160	174	187	204	227	252	268	289	312	345	372	401	423	480	532	597	644	704	756	811	867	922	978	1034	1090
114 (289.6)	183	166	178	198	214	236	259	284	307	326	368	391	420	444	499	555	620	672	741	807	875	936	996	1059	1120	1181
120 (304.8)	186	169	187	208	225	252	268	295	317	339	381	404	432	465	529	580	650	709	766	824	881	942	1005	1065	1127	1189
126 (320.1)	194	176	198	220	230	259	286	308	329	349	395	426	456	483	546	603	677	737	795	855	911	974	1037	1100	1165	1227

NOTE: Smallest width available 5½" (14.0 cm) exact.
Widths from 5½" (14.0 cm) to 8⅝" (22.8 cm) are center tilt only.
143¾" (365.2 cm) maximum single blind.

Multiple Blinds on One Headrail:
Blinds less than 142" (360.7 cm): add surcharge: \$44 two on one headrail
\$44 three on one headrail
Blind widths 142" (360.7 cm) to 192" (487.7 cm): no charge

1" (2.6 cm) Slats .008 Gauge

Height up to inches (cm)	Width up to inches (cm)																									
	12 (30.5)	23 (58.5)	26 (66.1)	29 (73.7)	32 (81.3)	36 (91.5)	40 (101.6)	44 (111.8)	48 (122.0)	52 (132.1)	57 (144.8)	62 (157.5)	67 (170.2)	72 (182.9)	82 (208.3)	92 (233.7)	102 (259.1)	112 (284.5)	122 (309.9)	132 (335.3)	142 (360.7)	152 (386.1)	162 (411.5)	172 (436.9)	182 (462.3)	192 (487.7)
42 (106.7)	\$109	92	94	103	114	122	134	152	158	166	184	196	214	225	254	280	317	343	372	404	423	455	489	522	554	585
48 (122.0)	111	94	103	116	122	139	152	161	171	183	208	220	233	247	280	312	346	372	409	441	470	505	542	578	614	649
54 (137.2)	119	103	116	122	126	152	161	171	183	194	225	241	254	272	302	339	377	409	444	478	512	550	588	625	661	697
60 (152.4)	133	116	122	126	147	161	171	184	196	214	241	258	277	289	329	363	409	444	479	517	547	589	630	670	711	752
66 (167.7)	137	119	126	147	158	171	184	196	214	231	258	277	290	314	350	386	441	475	519	558	597	639	681	722	764	806
72 (182.9)	142	123	139	156	162	183	196	214	231	247	277	294	314	339	377	419	470	512	558	597	636	682	727	774	822	867
78 (198.2)	153	134	152	161	171	194	210	227	247	262	290	314	339	355	408	444	502	542	594	636	677	724	772	820	868	915
84 (213.4)	163	147	158	171	183	208	225	242	258	280	314	337	355	377	430	471	532	581	632	674	717	767	819	870	921	973
90 (228.6)	173	156	166	179	194	220	241	254	277	290	329	350	372	404	452	502	558	611	665	716	764	819	873	929	983	1037
96 (243.9)	178	161	171	184	198	231	250	272	289	312	346	369	401	422	475	529	594	641	704	755	802	859	914	970	1025	1081
102 (259.1)	183	166	183	196	214	241	262	281	302	328	367	388	419	444	502	555	625	677	736	792	850	911	970	1028	1088	1146
108 (274.4)	192	175	191	208	225	250	277	294	317	343	381	409	441	465	529	584	656	709	772	831	893	953	1014	1076	1137	1200
114 (289.6)	201	183	196	220	233	262	285	312	337	355	404	430	461	488	547	611	683	741	815	886	961	1030	1098	1167	1235	1304
120 (304.8)	204	184	208	227	247	277	294	328	349	372	419	444	478	512	581	637	716	780	843	906	970	1037	1105	1173	1242	1311
126 (320.1)	212	194	220	241	254	285	314	339	363	386	437	470	502	532	601	665	747	811	875	939	1001	1070	1140	1208	1278	1348

NOTE: Smallest width available 5½" (14.0 cm) exact.
Widths from 5½" (14.0 cm) to 8⅝" (22.8 cm) are center tilt only.
143¾" (365.2 cm) maximum single blind.

Multiple Blinds on One Headrail:
Blinds less than 142" (360.7 cm): add surcharge: \$44 two on one headrail
\$44 three on one headrail
Blind widths 142" (360.7 cm) to 192" (487.7 cm): no charge

Colors

Alabaster 112	Flax 541	Pitch Black 033	Premium Colors
Almond 724	Forest Shadow 087	Raw Umber 006	(10% Surcharge)
Almost White Gloss 065	Granite 044	Real Red 085	Alabaster Pearl 326
Aluminum 034	Gray Dawn 405	Rock Gray 399	Ash Metallic 126
Beige 011	Gray Haze 983	Silver 737	Beige Pearl 328
Birch White 375	Greige 122	Skyline 680	Brushed Aluminum 121
Black Satin 233	Hunter Green 154	Smokey Gray 026	Fawn Pearl 327
Buff 624	Ice 778	Snowcap White 386	Polished Aluminum 741
Burgundy 653	Lamplight 904	Stucco 963	White Pearl 637
Cameo 607	Magnet 648	Tender Taupe 103	
Char Brown 062	Matte White 042	True Blue 089	
Coconut 630	Mercury 771	True White 544	
Creamy Beige 670	Midnight Blue 057	U.N. Gray 095	
Crystal White 629	Milk Chocolate 060	Vanilla 100	
Desert Sand 625	Navajo White 376	White Gloss 005	
Fawn 031	Parchment 535	White Satin 205	

Price Charts

Price Group D: 1" (2.6 cm) Insignia®

1" (2.6 cm) Slats .006 Gauge

Height up to inches (cm) ↓	Width up to inches (cm) →																									
	12 (30.5)	23 (58.5)	26 (66.1)	29 (73.7)	32 (81.3)	36 (91.5)	40 (101.6)	44 (111.8)	48 (122.0)	52 (132.1)	57 (144.8)	62 (157.5)	67 (170.2)	72 (182.9)	82 (208.3)	92 (233.7)	102 (259.1)	112 (284.5)	120 (304.8)	130 (330.2)	140 (355.6)	150 (381.0)	160 (406.4)	170 (431.8)	180 (457.2)	192 (487.7)
42 (106.7)	\$89	71	75	84	90	101	107	112	118	130	148	155	169	175	197	218	248	268	292	317	340	366	390	414	439	463
48 (122.0)	94	75	84	91	100	108	116	124	131	141	161	172	180	194	218	242	271	293	324	350	377	404	431	457	484	511
54 (137.2)	102	84	91	100	104	116	124	136	146	154	173	184	197	213	236	263	296	322	348	379	411	442	474	505	535	566
60 (152.4)	108	91	100	104	111	124	136	148	155	169	188	199	216	226	258	283	322	346	381	414	447	481	515	548	582	615
66 (167.7)	112	96	104	111	118	136	148	155	171	179	201	217	230	247	276	305	342	373	407	442	478	514	549	585	620	656
72 (182.9)	117	101	109	117	125	144	155	169	179	190	217	232	247	263	296	326	368	400	438	476	514	551	589	628	665	703
78 (198.2)	123	107	116	124	136	154	165	177	190	206	230	247	263	279	315	348	390	423	463	504	544	584	624	664	704	744
84 (213.4)	128	112	120	131	146	161	173	190	201	217	247	262	279	296	335	368	414	452	493	535	579	620	663	705	747	790
90 (228.6)	134	117	130	141	153	171	184	199	216	229	258	276	293	315	355	388	439	478	522	565	610	655	700	744	789	832
96 (243.9)	143	124	136	149	161	179	194	213	225	245	271	289	310	330	373	413	463	505	549	595	640	686	732	777	823	868
102 (259.1)	148	130	144	155	169	188	206	220	236	253	287	305	326	346	390	438	487	531	581	630	678	727	776	825	875	923
108 (274.4)	154	137	149	162	175	196	216	232	251	268	298	322	342	364	413	458	515	557	604	655	705	755	806	855	905	956
114 (289.6)	158	141	157	172	183	209	225	247	263	283	310	335	360	378	430	477	532	583	633	684	736	787	838	888	939	991
120 (304.8)	164	148	163	179	194	217	233	258	273	296	325	350	374	393	446	495	554	606	659	713	769	823	878	932	987	1041
126 (320.1)	170	153	173	188	206	226	247	268	285	307	337	366	388	409	463	515	573	633	686	744	802	860	918	975	1034	1091

NOTE: Smallest width available 5½" (14.0 cm) exact.
Widths from 5½" (14.0 cm) to 8⅝" (22.8 cm) are center tilt only.

Multiple Blinds on One Headrail:
Blinds less than 120" (304.8 cm): add surcharge: \$44 two on one headrail
\$44 three on one headrail
Blind widths 120" (304.8 cm) to 192" (487.7 cm): no charge

Colors

Alabaster	112	Fawn	031	Real Red	085	Premium Colors (10% Surcharge) Brushed Aluminum 121 Polished Aluminum 741
Almost White Gloss	065	Flax	541	Silver	737	
Aluminum	034	Forest Shadow	087	Smokey Gray	026	
Beige	011	Granite	044	Snowcap White	386	
Black Satin	233	Gray Haze	983	Stucco	963	
Buff	624	Greige	122	True Blue	089	
Burgundy	653	Ice	778	True White	544	
Cameo	607	Lamplight	904	U.N. Gray	095	
Char Brown	062	Matte White	042	Vanilla	100	
Coconut	630	Milk Chocolate	060	White Gloss	005	
Creamy Beige	670	Parchment	535	White Satin	205	
Crystal White	629	Pitch Black	033			
Desert Sand	625	Raw Umber	006			

Price Charts

Price Group E: 1/2" (1.3 cm) Micro Supreme

1/2" (1.3 cm) Micro Supreme Blinds

Height up to inches (cm) ↓	Width up to inches (cm) →																									
	12 (30.5)	23 (58.5)	26 (66.1)	29 (73.7)	32 (81.3)	36 (91.5)	40 (101.6)	44 (111.8)	48 (122.0)	52 (132.1)	57 (144.8)	62 (157.5)	67 (170.2)	72 (182.9)	82 (208.3)	92 (233.7)	102 (259.1)	112 (284.5)	120 (304.8)	130 (330.2)	140 (355.6)	150 (381.0)	160 (406.4)	170 (431.8)	180 (457.2)	192 (487.7)
42 (106.7)	\$119	103	108	114	123	143	153	163	174	186	212	223	240	255	287	317	357	390	423	460	496	533	570	606	643	681
48 (122.0)	124	108	114	127	137	155	165	178	190	202	228	245	265	280	317	349	394	425	466	507	548	589	632	672	713	755
54 (137.2)	131	114	127	140	145	165	180	191	208	223	246	269	287	306	342	384	426	465	506	548	590	634	676	718	760	803
60 (152.4)	144	125	137	145	159	178	191	210	223	240	270	287	311	331	374	409	465	502	548	596	642	690	737	782	830	878
66 (167.7)	153	136	145	159	171	191	210	223	240	257	289	310	335	355	400	443	499	540	588	637	685	734	780	829	878	925
72 (182.9)	160	143	157	171	181	206	223	240	257	275	310	335	355	384	426	473	533	581	633	685	738	791	844	896	950	1002
78 (198.2)	170	153	165	180	191	220	236	257	275	294	332	352	384	402	456	505	568	615	673	728	782	840	894	950	1004	1060
84 (213.4)	179	161	176	190	208	228	246	273	289	311	349	375	402	426	484	534	602	656	716	776	838	898	959	1020	1080	1142
90 (228.6)	188	171	186	201	219	240	269	284	310	330	370	396	425	455	512	565	640	694	756	817	880	941	1004	1066	1127	1189
96 (243.9)	195	178	191	215	228	257	280	302	323	347	390	419	451	479	542	598	673	728	795	861	925	991	1057	1121	1187	1253
102 (259.1)	206	187	206	223	240	270	294	315	340	363	412	437	473	502	568	629	705	770	840	907	976	1044	1114	1183	1252	1321
108 (274.4)	213	194	215	231	252	283	310	335	359	384	426	461	497	529	598	660	740	808	878	951	1023	1094	1167	1238	1310	1383

NOTE: Smallest width available 5 1/2" (14.0 cm) exact.
Widths from 5 1/2" (14.0 cm) to 8 5/16" (22.8 cm) are center tilt only.

Multiple Blinds on One Headrail:
Blinds less than 120" (304.8 cm): add surcharge: \$44 two on one headrail
\$44 three on one headrail
Blind widths 120" (304.8 cm) to 192" (487.7 cm): no charge

Colors

Alabaster	112	Fawn	031	Pitch Black	033	Premium Colors (10% Surcharge)		
Almost White Gloss	065	Flax	541	Raw Umber	006			
Aluminum	034	Gray Haze	983	Smokey Gray	026		Alabaster Pearl	326
Beige	011	Greige	122	True White	544		Brushed Aluminum	121
Black Satin	233	Lamplight	904	Vanilla	100		Fawn Pearl	327
Char Brown	062	Matte White	042	White Gloss	005			
Creamy Beige	670	Milk Chocolate	060	White Satin	205			
Crystal White	629	Parchment	535					

Price Charts

Price Group F: 2" (5.1 cm) Grandeur™

2" (5.1 cm) Slats

Height up to inches (cm) ↓	Width up to inches (cm) →																				
	12 (30.5)	23 (58.5)	26 (66.1)	29 (73.7)	32 (81.3)	36 (91.5)	40 (101.6)	44 (111.8)	48 (122.0)	52 (132.1)	57 (144.8)	62 (157.5)	67 (170.2)	72 (182.9)	82 (208.3)	92 (233.7)	102 (259.1)	112 (284.5)	122 (309.9)	132 (335.3)	142 (360.7)
42 (106.7)	\$122	106	111	119	128	147	157	169	178	194	218	230	250	262	293	328	368	398	432	467	496
48 (122.0)	127	111	119	134	144	160	174	183	198	213	236	254	272	288	328	357	402	437	479	511	543
54 (137.2)	137	119	134	144	154	174	183	200	216	227	258	279	293	313	353	391	439	479	520	558	597
60 (152.4)	152	133	144	154	165	183	200	218	230	252	280	295	320	337	383	420	479	517	565	602	644
66 (167.7)	157	140	153	165	178	200	218	230	253	267	299	321	341	367	412	455	511	553	603	649	692
72 (182.9)	165	149	162	176	187	214	229	252	267	284	321	346	367	391	439	487	545	597	649	694	742
78 (198.2)	174	157	174	183	200	227	247	264	284	304	341	367	391	416	470	517	581	635	691	742	791
84 (213.4)	183	166	179	198	216	236	258	281	299	321	365	390	416	439	499	546	615	672	731	787	835
90 (228.6)	194	176	194	210	225	253	279	294	320	339	383	412	437	465	529	581	653	712	772	831	887
96 (243.9)	201	183	200	220	236	267	288	313	335	363	402	431	461	491	555	612	691	752	816	873	938
102 (259.1)	214	196	214	229	252	280	304	329	353	378	426	456	487	517	583	649	721	791	863	925	985
108 (274.4)	219	201	222	237	262	290	320	346	372	398	442	479	511	541	612	682	760	825	902	970	1035
114 (289.6)	230	214	230	253	272	307	335	365	390	416	465	499	536	566	644	712	796	867	947	1017	1081
120 (304.8)	236	220	237	263	284	320	346	375	404	431	487	520	558	595	672	746	832	906	990	1061	1131
126 (320.1)	244	227	253	277	294	335	365	392	422	455	507	541	581	616	699	772	867	941	1035	1103	1177

NOTE: Smallest width available 9" (22.9 cm) exact.
Widths from 9" (22.9 cm) to 11¹⁵/₁₆" (30.4 cm) are center tilt only.

Multiple Blinds on One Headrail Blinds less than 120" (304.8 cm):
Add surcharge: \$44 two on one headrail
\$44 three on one headrail
Blind widths 120" (304.8 cm) to 142" (360.7 cm): No charge

2" (5.1 cm) Slats with Cloth Tapes

Height up to inches (cm) ↓	Width up to inches (cm) →																				
	12 (30.5)	23 (58.5)	26 (66.1)	29 (73.7)	32 (81.3)	36 (91.5)	40 (101.6)	44 (111.8)	48 (122.0)	52 (132.1)	57 (144.8)	62 (157.5)	67 (170.2)	72 (182.9)	82 (208.3)	92 (233.7)	102 (259.1)	112 (284.5)	122 (309.9)	132 (335.3)	142 (360.7)
42 (106.7)	\$146	127	133	143	154	176	188	203	214	233	262	276	300	314	352	394	442	478	518	560	595
48 (122.0)	152	133	143	161	173	192	209	220	238	256	283	305	326	346	394	428	482	524	575	613	652
54 (137.2)	164	143	161	173	185	209	220	240	259	272	310	335	352	376	424	469	527	575	624	670	716
60 (152.4)	182	160	173	185	198	220	240	262	276	302	336	354	384	404	460	504	575	620	678	722	773
66 (167.7)	188	168	184	198	214	240	262	276	304	320	359	385	409	440	494	546	613	664	724	779	830
72 (182.9)	198	179	194	211	224	257	275	302	320	341	385	415	440	469	527	584	654	716	779	833	890
78 (198.2)	209	188	209	220	240	272	296	317	341	365	409	440	469	499	564	620	697	762	829	890	949
84 (213.4)	220	199	215	238	259	283	310	337	359	385	438	468	499	527	599	655	738	806	877	944	1002
90 (228.6)	233	211	233	252	270	304	335	353	384	407	460	494	524	558	635	697	784	854	926	997	1064
96 (243.9)	241	220	240	264	283	320	346	376	402	436	482	517	553	589	666	734	829	902	979	1048	1126
102 (259.1)	257	235	257	275	302	336	365	395	424	454	511	547	584	620	700	779	865	949	1036	1110	1182
108 (274.4)	263	241	266	284	314	348	384	415	446	478	530	575	613	649	734	818	912	990	1082	1164	1242
114 (289.6)	276	257	276	304	326	368	402	438	468	499	558	599	643	679	773	854	955	1040	1136	1220	1297
120 (304.8)	283	264	284	316	341	384	415	450	485	517	584	624	670	714	806	895	998	1087	1188	1273	1357
126 (320.1)	293	272	304	332	353	402	438	470	506	546	608	649	697	739	839	926	1040	1129	1242	1324	1412

NOTE: Smallest width available 9" (22.9 cm) exact.
Widths from 9" (22.9 cm) to 11¹⁵/₁₆" (30.4 cm) are center tilt only.

Multiple Blinds on One Headrail Blinds less than 120" (304.8 cm):
Add surcharge: \$44 two on one headrail
\$44 three on one headrail
Blind widths 120" (304.8 cm) to 142" (360.7 cm): No charge

Colors

Alabaster	112	Hunter Green	154
Almond	724	Lamplight	904
Almost White Gloss	065	Raw Umber	006
Black Satin	233	Snowcap White	386
Char Brown	062	Stucco	963
Creamy Beige	670	True White	544
Gray Haze	983	White Gloss	005
Greige	122	White Satin	205

Premium Colors (10% Surcharge)

Alabaster Pearl	326
Ash Metallic	126
Brushed Aluminum	121
Polished Aluminum	741

Price Charts

Price Group G: 1" (2.6 cm) Skylights

Dual Headrail and Incline Wire Blinds .006 Gauge

Height up to inches (cm) ↓	Width up to inches (cm) →																				
	12 (30.5)	23 (58.5)	26 (66.1)	29 (73.7)	32 (81.3)	36 (91.5)	40 (101.6)	44 (111.8)	48 (122.0)	52 (132.1)	57 (144.8)	62 (157.5)	67 (170.2)	72 (182.9)	82 (208.3)	92 (233.7)	102 (259.1)	112 (284.5)	122 (309.9)	132 (335.3)	142 (360.7)
42 (106.7)	\$209	190	204	210	220	274	284	292	304	311	365	388	408	418	488	519	565	592	625	674	723
48 (122.0)	220	204	214	220	230	288	302	310	322	333	388	415	431	447	527	560	606	642	672	727	780
54 (137.2)	226	210	223	230	245	306	320	329	339	350	415	442	457	477	565	594	648	685	719	779	839
60 (152.4)	234	218	230	242	257	322	335	343	360	371	438	469	487	501	594	635	696	735	770	833	898
66 (167.7)	244	226	245	253	268	337	348	364	379	393	464	493	519	532	638	674	742	780	820	888	956
72 (182.9)	255	236	254	266	281	350	366	381	396	414	487	522	545	564	654	711	787	825	868	939	1010
78 (198.2)	267	250	267	279	296	371	384	398	414	422	520	554	577	601	712	760	846	889	931	1007	1082
84 (213.4)	274	257	275	287	306	381	398	419	434	449	532	572	597	623	742	790	869	920	967		
90 (228.6)	283	266	287	298	320	398	419	436	451	470	560	597	628	648	779	826	916	966	1019		
96 (243.9)	290	274	296	308	330	415	434	451	470	490	586	625	654	678	812	866					
102 (259.1)	302	284	307	322	341	433	449	470	493	515	606	648	679	682	850	906					
108 (274.4)	307	289	315	330	353	446	466	488	511	530	632										
114 (289.6)	321	303	329	341	366																
120 (304.8)	329	310	335	350	380																
126 (320.1)	338	322	343	364	393																

Incline wire available only in sizes to the left of the dotted line.

Dual headrail available only in sizes above the heavy line.

Dual Headrail and Incline Wire Blinds .008 Gauge

Height up to inches (cm) ↓	Width up to inches (cm) →																				
	12 (30.5)	23 (58.5)	26 (66.1)	29 (73.7)	32 (81.3)	36 (91.5)	40 (101.6)	44 (111.8)	48 (122.0)	52 (132.1)	57 (144.8)	62 (157.5)	67 (170.2)	72 (182.9)	82 (208.3)	92 (233.7)	102 (259.1)	112 (284.5)	122 (309.9)	132 (335.3)	142 (360.7)
42 (106.7)	\$226	210	223	229	242	302	311	322	335	342	401	428	447	461	536	570	623	652	686	742	796
48 (122.0)	239	223	234	242	254	320	331	341	356	365	428	457	474	493	581	616	669	706	739	800	858
54 (137.2)	248	229	245	254	270	337	348	361	374	387	457	486	502	526	623	654	713	753	791	857	921
60 (152.4)	258	239	254	267	281	356	370	380	394	410	480	516	535	551	654	699	765	807	847	916	988
66 (167.7)	266	250	270	279	294	371	384	400	415	433	511	543	570	587	702	742	815	858	904	976	1049
72 (182.9)	279	262	280	292	308	387	405	418	436	456	535	573	599	620	719	785	864	907	958	1033	1112
78 (198.2)	292	275	293	306	327	410	422	439	456	466	572	610	633	664	786	839	929	978	1025	1110	1190
84 (213.4)	298	281	303	315	337	418	439	462	477	495	587	629	657	683	815	868	959	1012	1065		
90 (228.6)	309	292	315	329	348	439	462	478	496	517	616	657	691	713	857	908	1008	1064	1120		
96 (243.9)	319	302	327	339	362	457	477	496	517	537	644	686	719	745	894	956					
102 (259.1)	329	311	338	356	375	475	495	517	543	565	669	713	748	750	933	996					
108 (274.4)	337	321	346	362	388	491	512	536	563	583	696										
114 (289.6)	349	333	361	375	405																
120 (304.8)	360	341	370	387	416																
126 (320.1)	372	356	380	400	433																

Incline wire available only in sizes to the left of the dotted line.

Dual headrail available only in sizes above the heavy line.

Colors

Alabaster 112	Flax 541	Pitch Black 033	Premium Colors
Almond 724	Forest Shadow 087	Raw Umber 006	(10% Surcharge)
Almost White Gloss 065	Granite 044	Real Red 085	Alabaster Pearl 326
Aluminum 034	Gray Dawn 405	Rock Gray 399	Ash Metallic 126
Beige 011	Gray Haze 983	Silver 737	Beige Pearl 328
Birch White 375	Greige 122	Skyline 680	Brushed Aluminum 121
Black Satin 233	Hunter Green 154	Smokey Gray 026	Fawn Pearl 327
Buff 624	Ice 778	Snowcap White 386	Polished Aluminum 741
Burgundy 653	Lamplight 904	Stucco 963	White Pearl 637
Cameo 607	Magnet 648	Tender Taupe 103	
Char Brown 062	Matte White 042	True Blue 089	
Coconut 630	Mercury 771	True White 544	
Creamy Beige 670	Midnight Blue 057	U.N. Gray 095	
Crystal White 629	Milk Chocolate 060	Vanilla 100	
Desert Sand 625	Navajo White 376	White Gloss 005	
Fawn 031	Parchment 535	White Satin 205	

Price Charts

Price Group H: 1" (2.6 cm) Skylights—Incline Wire Specialty Shapes

Incline Wire: Side Cuts, Inverted Triangles, Angle Tops and Bottoms .006 Gauge

Height up to inches (cm) ↓	Width up to inches (cm) →																		
	12 (30.5)	23 (58.5)	26 (66.1)	29 (73.7)	32 (81.3)	36 (91.5)	40 (101.6)	44 (111.8)	48 (122.0)	52 (132.1)	57 (144.8)	62 (157.5)	67 (170.2)	72 (182.9)	82 (208.3)	92 (233.7)	102 (259.1)	112 (284.5)	122 (309.9)
42 (106.7)	\$526	510	522	527	537	629	640	647	659	704	757	781	801	858	929	959	1080	1110	1139
48 (122.0)	538	522	531	537	549	644	657	668	678	727	781	808	825	888	967	998	1122	1158	1186
54 (137.2)	545	527	542	549	564	661	674	683	696	745	808	834	851	917	1006	1035	1164	1200	1234
60 (152.4)	554	536	549	561	574	678	692	700	713	763	830	861	880	941	1035	1075	1211	1250	1285
66 (167.7)	563	545	564	572	587	694	704	719	735	787	857	886	912	973	1078	1115	1256	1295	1336
72 (182.9)	573	555	573	583	599	706	722	737	752	807	880	915	938	1004	1093	1151	1301	1340	1384
78 (198.2)	586	569	586	595	616	728	740	753	770	815	913	948	969	1042	1153	1201	1359	1404	1447
84 (213.4)	591	574	592	604	625	737	753	776	790	844	926	965	991	1062	1181	1230	1385	1436	1483
90 (228.6)	600	583	604	618	636	753	776	791	807	862	953	991	1020	1089	1219	1265	1431	1481	1533
96 (243.9)	608	591	616	628	647	772	790	807	826	884	978	1017	1046	1118	1254	1308			
102 (259.1)	620	601	627	640	659	789	805	826	850	907	1002	1042	1073	1122	1290	1345			
108 (274.4)	627	608	633	647	672	803	820	846	865	924	1025								
114 (289.6)	639	623	645	659	685														
120 (304.8)	645	629	654	670	698														
126 (320.1)	657	640	664	682	711														

Incline Wire: Side Cuts, Inverted Triangles, Angle Tops and Bottoms .008 Gauge

Height up to inches (cm) ↓	Width up to inches (cm) →																		
	12 (30.5)	23 (58.5)	26 (66.1)	29 (73.7)	32 (81.3)	36 (91.5)	40 (101.6)	44 (111.8)	48 (122.0)	52 (132.1)	57 (144.8)	62 (157.5)	67 (170.2)	72 (182.9)	82 (208.3)	92 (233.7)	102 (259.1)	112 (284.5)	122 (309.9)
42 (106.7)	\$545	527	542	547	561	657	669	678	692	737	795	820	842	902	976	1010	1137	1168	1201
48 (122.0)	560	542	554	561	573	674	686	698	708	757	820	851	866	933	1020	1061	1182	1223	1254
54 (137.2)	565	547	564	573	588	694	704	717	732	780	851	879	896	966	1062	1093	1230	1268	1306
60 (152.4)	577	560	573	586	599	708	727	736	750	803	874	908	929	991	1093	1139	1282	1322	1361
66 (167.7)	586	569	588	595	615	728	740	754	772	826	904	936	963	1028	1143	1181	1331	1373	1418
72 (182.9)	595	579	597	610	628	744	758	775	791	850	929	966	992	1061	1159	1224	1380	1422	1472
78 (198.2)	610	592	614	625	644	763	779	795	811	858	965	1004	1028	1103	1225	1277	1444	1493	1539
84 (213.4)	618	599	623	633	655	775	795	816	833	888	979	1023	1049	1123	1256	1309	1473	1528	1580
90 (228.6)	628	610	633	645	669	795	816	834	853	911	1008	1049	1083	1154	1296	1348	1524	1578	1635
96 (243.9)	636	620	644	658	681	812	833	853	870	931	1038	1080	1114	1184	1334	1396			
102 (259.1)	647	631	657	673	695	831	851	870	900	959	1062	1110	1142	1191	1373	1436			
108 (274.4)	655	638	665	681	706	849	866	893	917	976	1089								
114 (289.6)	669	649	679	695	722														
120 (304.8)	678	659	690	704	736														
126 (320.1)	691	673	698	718	750														

Colors

Alabaster 112	Flax 541	Pitch Black 033	Premium Colors
Almond 724	Forest Shadow 087	Raw Umber 006	(10% Surcharge)
Almost White Gloss 065	Granite 044	Real Red 085	Alabaster Pearl 326
Aluminum 034	Gray Dawn 405	Rock Gray 399	Ash Metallic 126
Beige 011	Gray Haze 983	Silver 737	Beige Pearl 328
Birch White 375	Greige 122	Skyline 680	Brushed Aluminum 121
Black Satin 233	Hunter Green 154	Smokey Gray 026	Fawn Pearl 327
Buff 624	Ice 778	Snowcap White 386	Polished Aluminum 741
Burgundy 653	Lamplight 904	Stucco 963	White Pearl 637
Cameo 607	Magnet 648	Tender Taupe 103	
Char Brown 062	Matte White 042	True Blue 089	
Coconut 630	Mercury 771	True White 544	
Creamy Beige 670	Midnight Blue 057	U.N. Gray 095	
Crystal White 629	Milk Chocolate 060	Vanilla 100	
Desert Sand 625	Navajo White 376	White Gloss 005	
Fawn 031	Parchment 535	White Satin 205	

Price Charts

Price Group H: 1" (2.6 cm) Skylights—Incline Wire Specialty Shapes

Incline Wire: Octagons, Triangles, and Other Shapes .006 Gauge

Height up to inches (cm) ↓	Width up to inches (cm) →																		
	12 (30.5)	23 (58.5)	26 (66.1)	29 (73.7)	32 (81.3)	36 (91.5)	40 (101.6)	44 (111.8)	48 (122.0)	52 (132.1)	57 (144.8)	62 (157.5)	67 (170.2)	72 (182.9)	82 (208.3)	92 (233.7)	102 (259.1)	112 (284.5)	122 (309.9)
42 (106.7)	\$630	614	625	631	641	750	760	770	781	847	900	921	941	1037	1106	1137	1295	1323	1354
48 (122.0)	641	625	635	641	652	765	779	789	800	865	921	950	965	1066	1146	1177	1337	1373	1402
54 (137.2)	647	631	644	652	668	785	796	805	816	885	950	974	991	1095	1182	1213	1380	1415	1450
60 (152.4)	657	640	652	664	678	800	812	821	836	906	970	1003	1020	1119	1213	1254	1426	1463	1499
66 (167.7)	666	647	668	674	691	814	827	842	856	926	997	1028	1051	1151	1256	1292	1472	1512	1552
72 (182.9)	677	658	677	686	702	829	846	858	874	948	1020	1056	1078	1181	1272	1330	1517	1554	1600
78 (198.2)	690	672	690	699	718	850	861	876	890	958	1052	1088	1111	1220	1331	1380	1575	1621	1662
84 (213.4)	695	678	696	707	728	858	876	898	912	983	1068	1104	1132	1239	1359	1408	1602	1650	1697
90 (228.6)	703	686	707	719	740	876	898	913	929	1004	1092	1132	1160	1267	1398	1444	1645	1696	1749
96 (243.9)	711	695	718	732	750	893	912	929	948	1024	1119	1158	1187	1295	1431	1485			
102 (259.1)	722	704	731	744	762	911	926	948	970	1046	1142	1182	1213	1300	1466	1524			
108 (274.4)	731	711	737	750	775	924	942	966	988	1065	1166								
114 (289.6)	742	723	749	762	789														
120 (304.8)	749	733	756	773	801														
126 (320.1)	759	744	765	786	814														

Incline Wire: Octagons, Triangles, and Other Shapes .008 Gauge

Height up to inches (cm) ↓	Width up to inches (cm) →																		
	12 (30.5)	23 (58.5)	26 (66.1)	29 (73.7)	32 (81.3)	36 (91.5)	40 (101.6)	44 (111.8)	48 (122.0)	52 (132.1)	57 (144.8)	62 (157.5)	67 (170.2)	72 (182.9)	82 (208.3)	92 (233.7)	102 (259.1)	112 (284.5)	122 (309.9)
42 (106.7)	\$647	631	644	649	664	779	790	800	812	877	934	962	982	1078	1154	1187	1350	1382	1416
48 (122.0)	661	644	657	664	677	796	808	818	831	900	962	991	1008	1112	1199	1232	1399	1438	1468
54 (137.2)	669	649	668	677	692	814	827	839	853	920	991	1019	1037	1144	1239	1272	1445	1484	1522
60 (152.4)	680	661	677	690	702	831	849	857	870	942	1015	1047	1069	1169	1272	1317	1497	1537	1576
66 (167.7)	690	672	692	699	717	850	861	877	893	966	1043	1077	1103	1204	1321	1359	1548	1588	1634
72 (182.9)	699	682	700	712	732	864	882	896	913	989	1069	1106	1134	1237	1337	1402	1594	1637	1687
78 (198.2)	712	696	713	728	748	886	902	916	933	998	1104	1144	1168	1282	1403	1456	1660	1709	1754
84 (213.4)	720	702	723	737	757	896	916	939	956	1029	1120	1162	1191	1301	1435	1488	1688	1743	1795
90 (228.6)	732	712	737	749	772	916	939	958	973	1049	1149	1191	1224	1332	1475	1526	1739	1793	1851
96 (243.9)	740	722	748	760	785	934	956	973	993	1073	1178	1220	1254	1363	1513	1574			
102 (259.1)	751	735	758	776	798	954	971	993	1020	1098	1201	1250	1282	1369	1552	1613			
108 (274.4)	757	742	768	785	809	969	989	1015	1039	1118	1230								
114 (289.6)	772	753	781	798	826														
120 (304.8)	780	762	791	808	839														
126 (320.1)	794	776	801	820	854														

Colors

Alabaster 112	Flax 541	Pitch Black 033	Premium Colors
Almond 724	Forest Shadow 087	Raw Umber 006	(10% Surcharge)
Almost White Gloss 065	Granite 044	Real Red 085	Alabaster Pearl 326
Aluminum 034	Gray Dawn 405	Rock Gray 399	Ash Metallic 126
Beige 011	Gray Haze 983	Silver 737	Beige Pearl 328
Birch White 375	Greige 122	Skyline 680	Brushed Aluminum 121
Black Satin 233	Hunter Green 154	Smokey Gray 026	Fawn Pearl 327
Buff 624	Ice 778	Snowcap White 386	Polished Aluminum 741
Burgundy 653	Lamplight 904	Stucco 963	White Pearl 637
Cameo 607	Magnet 648	Tender Taupe 103	
Char Brown 062	Matte White 042	True Blue 089	
Coconut 630	Mercury 771	True White 544	
Creamy Beige 670	Midnight Blue 057	U.N. Gray 095	
Crystal White 629	Milk Chocolate 060	Vanilla 100	
Desert Sand 625	Navajo White 376	White Gloss 005	
Fawn 031	Parchment 535	White Satin 205	

Price Charts

Price Group I: Arches

1" (2.6 cm) Slats .006 Gauge

Height up to inches (cm) ↓	Width up to inches (cm) →																				
	12 (30.5)	23 (58.5)	26 (66.1)	29 (73.7)	32 (81.3)	36 (91.5)	40 (101.6)	44 (111.8)	48 (122.0)	52 (132.1)	57 (144.8)	62 (157.5)	67 (170.2)	72 (182.9)	82 (208.3)	92 (233.7)	102 (259.1)	112 (284.5)	122 (309.9)	132 (335.3)	142 (360.7)
42 (106.7)	\$740	723	728	735	745	752	762	776	880	888	906	915	930	939	966	989	1061	1082	1142	1169	1186
48 (122.0)	856	840	847	858	864	879	888	900	943	958	976	988	1003	1047	1078	1106	1177	1200	1270	1298	1323
54 (137.2)	941	924	936	942	948	966	976	984	1035	1043	1070	1086	1097	1149	1177	1210	1282	1311	1380	1409	1440
60 (152.4)	1032	1015	1020	1025	1042	1056	1064	1077	1123	1139	1164	1178	1196	1241	1276	1306	1388	1421	1489	1522	1552
66 (167.7)	1112	1093	1101	1119	1127	1139	1153	1162	1215	1232	1255	1272	1285	1342	1375	1404	1493	1524	1600	1635	1669
72 (182.9)	1256	1239	1252	1265	1273	1292	1303	1318	1346	1359	1385	1402	1421	1442	1475	1513	1696	1737	1791	1823	1858
78 (198.2)	1344	1327	1340	1349	1358	1380	1390	1409	1438	1450	1476	1498	1520	1534	1581	1613	1804	1841	1899	1936	1973
84 (213.4)	1432	1415	1425	1436	1448	1468	1484	1501	1525	1545	1576	1597	1613	1631	1680	1715	1908	1953	2011	2049	2088
90 (228.6)	1439	1422	1432	1445	1457	1480	1499	1512	1543	1554	1587	1609	1629	1657	1697	1743	1931	1979	2040	2086	2129
96 (243.9)	1445	1427	1436	1450	1462	1492	1508	1526	1553	1574	1605	1626	1653	1671	1718	1766	1964	2005	2076	2121	2162
102 (259.1)	1450	1432	1448	1459	1475	1499	1517	1534	1566	1585	1622	1641	1668	1692	1743	1791	1991	2038	2106	2156	2207
108 (274.4)	1457	1440	1454	1468	1484	1508	1530	1548	1580	1602	1634	1661	1688	1711	1766	1817	2020	2066	2139	2189	2242
114 (289.6)	1465	1448	1459	1480	1493	1517	1538	1561	1597	1613	1657	1680	1707	1732	1786	1841	2044	2094	2175	2238	2308
120 (304.8)	1466	1450	1468	1488	1503	1530	1548	1575	1607	1629	1668	1692	1720	1751	1814	1863	2072	2129	2202	2258	2314
126 (320.1)	1475	1457	1480	1499	1512	1538	1566	1587	1616	1638	1684	1714	1743	1770	1832	1889	2099	2158	2228	2286	2340

1" (2.6 cm) Slats .008 Gauge

Height up to inches (cm) ↓	Width up to inches (cm) →																				
	12 (30.5)	23 (58.5)	26 (66.1)	29 (73.7)	32 (81.3)	36 (91.5)	40 (101.6)	44 (111.8)	48 (122.0)	52 (132.1)	57 (144.8)	62 (157.5)	67 (170.2)	72 (182.9)	82 (208.3)	92 (233.7)	102 (259.1)	112 (284.5)	122 (309.9)	132 (335.3)	142 (360.7)
42 (106.7)	\$749	733	736	744	754	762	776	790	894	904	921	931	950	961	989	1015	1088	1114	1174	1204	1224
48 (122.0)	864	849	856	868	876	890	903	913	961	973	996	1008	1023	1070	1103	1135	1208	1232	1306	1337	1367
54 (137.2)	952	933	948	954	959	979	991	1002	1051	1062	1091	1110	1120	1174	1203	1239	1316	1346	1418	1452	1485
60 (152.4)	1042	1025	1032	1037	1056	1069	1078	1093	1142	1158	1186	1201	1220	1268	1306	1340	1425	1459	1530	1569	1600
66 (167.7)	1122	1104	1114	1132	1143	1154	1171	1179	1234	1254	1277	1296	1311	1371	1407	1439	1532	1566	1645	1686	1722
72 (182.9)	1267	1251	1264	1280	1288	1309	1321	1337	1368	1381	1411	1427	1448	1472	1509	1550	1739	1782	1841	1877	1915
78 (198.2)	1357	1340	1353	1364	1373	1398	1411	1429	1459	1473	1502	1526	1550	1567	1616	1653	1850	1889	1953	1994	2035
84 (213.4)	1445	1427	1439	1452	1465	1488	1503	1524	1549	1570	1605	1627	1644	1665	1718	1756	1955	2004	2068	2110	2153
90 (228.6)	1453	1436	1448	1461	1475	1499	1522	1533	1567	1581	1616	1639	1661	1692	1739	1788	1981	2034	2101	2152	2198
96 (243.9)	1460	1442	1452	1466	1480	1513	1529	1552	1580	1602	1635	1658	1688	1709	1760	1814	2016	2063	2139	2188	2234
102 (259.1)	1465	1448	1465	1476	1493	1522	1539	1560	1591	1614	1656	1675	1706	1732	1788	1841	2046	2099	2169	2225	2282
108 (274.4)	1474	1456	1472	1488	1503	1529	1556	1574	1607	1633	1668	1696	1728	1751	1814	1868	2079	2129	2207	2265	2324
114 (289.6)	1482	1465	1476	1499	1514	1539	1565	1589	1627	1644	1692	1718	1747	1774	1834	1895	2104	2160	2248	2319	2391
120 (304.8)	1483	1466	1488	1508	1526	1556	1574	1605	1638	1661	1706	1732	1763	1797	1864	1919	2137	2202	2274	2337	2398
126 (320.1)	1491	1475	1499	1522	1533	1565	1592	1616	1648	1673	1722	1754	1788	1817	1887	1948	2165	2229	2308	2371	2429

Template service fee: \$25 (net price)

Colors

Alabaster 112	Flax 541	Pitch Black 033	Premium Colors
Almond 724	Forest Shadow 087	Raw Umber 006	(10% Surcharge)
Almost White Gloss . . . 065	Granite 044	Real Red 085	Alabaster Pearl 326
Aluminum 034	Gray Dawn 405	Rock Gray 399	Ash Metallic 126
Beige 011	Gray Haze 983	Silver 737	Beige Pearl 328
Birch White 375	Greige 122	Skyline 680	Brushed Aluminum 121
Black Satin 233	Hunter Green 154	Smokey Gray 026	Fawn Pearl 327
Buff 624	Ice 778	Snowcap White 386	Polished Aluminum 741
Burgundy 653	Lamplight 904	Stucco 963	White Pearl 637
Cameo 607	Magnet 648	Tender Taupe 103	
Char Brown 062	Matte White 042	True Blue 089	
Coconut 630	Mercury 771	True White 544	
Creamy Beige 670	Midnight Blue 057	U.N. Gray 095	
Crystal White 629	Milk Chocolate 060	Vanilla 100	
Desert Sand 625	Navajo White 376	White Gloss 005	
Fawn 031	Parchment 535	White Satin 205	

Price Charts

Price Group J: Circles

To price use larger number for width.

1" (2.6 cm) Slats .006 Gauge

Height up to inches (cm) ↓	Width up to inches (cm) →													
	12 (30.5)	23 (58.5)	26 (66.1)	29 (73.7)	32 (81.3)	36 (91.5)	40 (101.6)	44 (111.8)	48 (122.0)	52 (132.1)	57 (144.8)	62 (157.5)	67 (170.2)	72 (182.9)
42 (106.7)	\$703	686	744	804	866	948	1030	1115	1203	1283	1389	1489	1592	1693
48 (122.0)	706	691	749	815	876	962	1042	1124	1214	1298	1409	1509	1611	1714
54 (137.2)	712	696	760	821	880	970	1052	1134	1227	1308	1425	1529	1630	1737
60 (152.4)	726	707	768	827	898	982	1062	1147	1237	1326	1440	1544	1648	1750
66 (167.7)	729	711	773	846	907	989	1075	1155	1254	1342	1454	1560	1662	1774
72 (182.9)	734	717	781	851	912	1003	1084	1173	1270	1354	1472	1576	1684	1796

1" (2.6 cm) Slats .008 Gauge

Height up to inches (cm) ↓	Width up to inches (cm) →													
	12 (30.5)	23 (58.5)	26 (66.1)	29 (73.7)	32 (81.3)	36 (91.5)	40 (101.6)	44 (111.8)	48 (122.0)	52 (132.1)	57 (144.8)	62 (157.5)	67 (170.2)	72 (182.9)
42 (106.7)	\$711	695	750	812	879	959	1042	1127	1218	1298	1408	1507	1611	1714
48 (122.0)	714	698	757	827	886	973	1057	1139	1230	1316	1427	1529	1633	1737
54 (137.2)	722	704	773	833	890	984	1068	1149	1243	1326	1445	1552	1653	1760
60 (152.4)	736	719	779	839	911	996	1077	1164	1255	1344	1462	1567	1674	1778
66 (167.7)	739	722	785	857	920	1006	1092	1174	1272	1363	1479	1585	1688	1802
72 (182.9)	745	728	795	864	925	1019	1101	1191	1291	1376	1497	1603	1712	1826

Template service fee: \$25 (net price)

Colors

Alabaster	112	Flax	541	Pitch Black	033
Almond	724	Forest Shadow	087	Raw Umber	006
Almost White Gloss	065	Granite	044	Real Red	085
Aluminum	034	Gray Dawn	405	Rock Gray	399
Beige	011	Gray Haze	983	Silver	737
Birch White	375	Greige	122	Skyline	680
Black Satin	233	Hunter Green	154	Smokey Gray	026
Buff	624	Ice	778	Snowcap White	386
Burgundy	653	Lamplight	904	Stucco	963
Cameo	607	Magnet	648	Tender Taupe	103
Char Brown	062	Matte White	042	True Blue	089
Coconut	630	Mercury	771	True White	544
Creamy Beige	670	Midnight Blue	057	U.N. Gray	095
Crystal White	629	Milk Chocolate	060	Vanilla	100
Desert Sand	625	Navajo White	376	White Gloss	005
Fawn	031	Parchment	535	White Satin	205

Premium Colors (10% Surcharge)

Alabaster Pearl	326
Ash Metallic	126
Beige Pearl	328
Brushed Aluminum	121
Fawn Pearl	327
Polished Aluminum	741
White Pearl	637

Price Charts

Price Group K: Side Cuts, Inverted Triangles, Angle Top and Bottom

1" (2.6 cm) Slats .006 Gauge

Height up to inches (cm) ↓	Width up to inches (cm) →																				
	12 (30.5)	23 (58.5)	26 (66.1)	29 (73.7)	32 (81.3)	36 (91.5)	40 (101.6)	44 (111.8)	48 (122.0)	52 (132.1)	57 (144.8)	62 (157.5)	67 (170.2)	72 (182.9)	82 (208.3)	92 (233.7)	102 (259.1)	112 (284.5)	122 (309.9)	132 (335.3)	142 (360.7)
42 (106.7)	\$417	400	402	410	419	466	475	488	496	542	560	569	583	640	668	691	800	820	849	978	996
48 (122.0)	419	402	410	420	428	478	488	499	508	557	578	588	601	659	691	718	825	849	880	1011	1037
54 (137.2)	426	410	420	428	433	488	499	508	520	567	592	608	620	682	708	744	851	880	912	1043	1075
60 (152.4)	438	420	428	433	449	499	508	522	530	583	608	624	640	698	733	760	880	912	942	1078	1110
66 (167.7)	441	423	433	449	459	508	522	530	546	600	624	640	652	721	753	785	908	938	976	1116	1150
72 (182.9)	445	430	442	456	464	520	530	546	564	615	640	655	674	744	776	812	933	971	1012	1150	1184
78 (198.2)	456	439	451	462	470	528	542	560	577	627	652	674	696	757	804	836	963	998	1043	1184	1223
84 (213.4)	468	449	459	470	482	541	555	573	586	642	674	695	711	776	825	860	989	1033	1078	1219	1258
90 (228.6)	473	456	467	478	491	551	572	582	601	652	685	706	727	801	844	888	1012	1061	1110	1256	1300
96 (243.9)	478	462	470	484	496	564	579	597	615	672	702	722	750	815	862	912	1043	1086	1143	1291	1332
102 (259.1)	484	467	482	493	510	572	588	606	627	683	719	740	765	836	888	934	1070	1119	1173	1326	1376
108 (274.4)	491	474	488	502	519	579	601	619	640	699	733	757	787	856	912	962	1100	1147	1204	1359	1413
114 (289.6)	498	482	493	515	527	588	610	633	657	711	753	777	805	876	930	984	1123	1175	1240	1409	1476
120 (304.8)	499	484	502	522	537	601	619	645	669	727	765	790	818	898	959	1008	1153	1211	1267	1426	1483
126 (320.1)	509	491	515	532	545	610	636	658	678	737	781	811	842	915	976	1033	1179	1239	1295	1456	1512

1" (2.6 cm) Slats .008 Gauge

Height up to inches (cm) ↓	Width up to inches (cm) →																				
	12 (30.5)	23 (58.5)	26 (66.1)	29 (73.7)	32 (81.3)	36 (91.5)	40 (101.6)	44 (111.8)	48 (122.0)	52 (132.1)	57 (144.8)	62 (157.5)	67 (170.2)	72 (182.9)	82 (208.3)	92 (233.7)	102 (259.1)	112 (284.5)	122 (309.9)	132 (335.3)	142 (360.7)
42 (106.7)	\$423	408	411	418	431	475	488	502	511	557	577	586	601	659	691	713	827	853	880	1015	1033
48 (122.0)	428	411	418	433	439	491	502	515	523	574	595	608	624	682	713	746	856	880	916	1049	1078
54 (137.2)	436	418	433	439	443	502	515	523	536	583	615	631	642	706	737	773	885	916	952	1086	1120
60 (152.4)	448	433	439	443	462	515	523	537	547	601	631	645	665	723	760	795	916	952	984	1124	1155
66 (167.7)	452	436	443	462	473	523	537	547	565	623	645	665	679	749	786	816	948	979	1024	1166	1203
72 (182.9)	458	441	454	470	477	536	547	565	583	635	665	682	702	773	809	851	974	1017	1064	1203	1240
78 (198.2)	469	451	466	475	486	546	561	579	597	648	679	702	727	790	840	876	1008	1046	1097	1240	1283
84 (213.4)	478	462	473	486	499	560	577	594	608	669	702	723	744	809	862	903	1037	1084	1135	1280	1322
90 (228.6)	487	470	482	495	510	572	592	604	628	679	713	739	757	836	884	933	1064	1115	1168	1321	1369
96 (243.9)	492	475	486	501	515	583	600	624	640	699	735	754	787	854	906	959	1097	1144	1204	1358	1404
102 (259.1)	498	482	499	511	527	592	614	632	652	712	752	775	804	876	933	984	1126	1179	1237	1396	1453
108 (274.4)	508	490	506	522	537	600	628	644	669	732	765	795	826	898	959	1012	1159	1211	1273	1435	1493
114 (289.6)	518	499	511	532	547	614	635	661	686	744	790	815	847	919	978	1039	1184	1240	1314	1489	1561
120 (304.8)	519	501	522	542	561	628	644	677	699	757	804	829	861	942	1010	1065	1218	1282	1342	1508	1569
126 (320.1)	526	510	532	555	569	635	665	690	708	772	820	854	886	962	1030	1092	1248	1311	1373	1539	1600

Template service fee: \$25 (net price)

Colors

Alabaster 112	Flax 541	Pitch Black 033	Premium Colors (10% Surcharge)
Almond 724	Forest Shadow 087	Raw Umber 006	
Almost White Gloss . . . 065	Granite 044	Real Red 085	
Aluminum 034	Gray Dawn 405	Rock Gray 399	
Beige 011	Gray Haze 983	Silver 737	
Birch White 375	Greige 122	Skyline 680	
Black Satin 233	Hunter Green 154	Smokey Gray 026	
Buff 624	Ice 778	Snowcap White 386	
Burgundy 653	Lamplight 904	Stucco 963	
Cameo 607	Magnet 648	Tender Taupe 103	
Char Brown 062	Matte White 042	True Blue 089	
Coconut 630	Mercury 771	True White 544	
Creamy Beige 670	Midnight Blue 057	U.N. Gray 095	
Crystal White 629	Milk Chocolate 060	Vanilla 100	
Desert Sand 625	Navajo White 376	White Gloss 005	
Fawn 031	Parchment 535	White Satin 205	

Price Charts

Price Group L: Octagons, Triangles

1" (2.6 cm) Slats .006 Gauge

Height up to inches (cm) ↓	Width up to inches (cm) →																				
	12 (30.5)	23 (58.5)	26 (66.1)	29 (73.7)	32 (81.3)	36 (91.5)	40 (101.6)	44 (111.8)	48 (122.0)	52 (132.1)	57 (144.8)	62 (157.5)	67 (170.2)	72 (182.9)	82 (208.3)	92 (233.7)	102 (259.1)	112 (284.5)	122 (309.9)	132 (335.3)	142 (360.7)
42 (106.7)	\$520	502	506	512	523	587	597	610	619	682	699	707	723	816	846	866	1015	1037	1064	1203	1220
48 (122.0)	523	506	512	524	530	600	610	623	629	698	718	731	744	839	866	896	1039	1064	1095	1236	1260
54 (137.2)	528	512	524	530	535	610	623	629	641	706	735	749	758	860	888	920	1066	1095	1126	1268	1300
60 (152.4)	542	524	530	535	552	623	629	642	652	723	749	762	780	876	911	939	1095	1126	1158	1303	1332
66 (167.7)	545	527	535	552	563	629	642	652	669	742	762	780	794	900	931	962	1123	1153	1192	1341	1375
72 (182.9)	549	531	545	560	567	641	652	669	685	753	780	796	814	920	954	991	1149	1187	1228	1375	1409
78 (198.2)	558	542	554	565	573	649	664	681	698	765	794	814	836	936	982	1015	1178	1214	1259	1409	1447
84 (213.4)	570	552	563	573	586	661	678	695	706	785	814	834	853	954	1003	1038	1204	1250	1294	1444	1483
90 (228.6)	577	560	570	582	594	673	694	703	723	794	826	849	865	978	1020	1066	1228	1275	1323	1481	1525
96 (243.9)	582	565	573	587	599	685	700	719	736	811	844	862	890	993	1041	1089	1259	1301	1358	1516	1557
102 (259.1)	587	570	586	595	614	694	708	731	748	825	860	880	907	1015	1066	1114	1286	1334	1386	1550	1602
108 (274.4)	594	578	591	604	623	700	723	740	760	840	870	900	926	1033	1089	1139	1316	1363	1421	1584	1638
114 (289.6)	602	586	595	618	631	708	733	754	779	853	894	917	945	1052	1110	1162	1340	1389	1456	1634	1700
120 (304.8)	603	587	604	625	641	723	740	768	790	865	907	930	961	1075	1137	1186	1369	1426	1483	1650	1707
126 (320.1)	612	594	618	636	647	733	757	780	800	877	921	953	982	1092	1154	1211	1396	1454	1512	1681	1737

1" (2.6 cm) Slats .008 Gauge

Height up to inches (cm) ↓	Width up to inches (cm) →																				
	12 (30.5)	23 (58.5)	26 (66.1)	29 (73.7)	32 (81.3)	36 (91.5)	40 (101.6)	44 (111.8)	48 (122.0)	52 (132.1)	57 (144.8)	62 (157.5)	67 (170.2)	72 (182.9)	82 (208.3)	92 (233.7)	102 (259.1)	112 (284.5)	122 (309.9)	132 (335.3)	142 (360.7)
42 (106.7)	\$527	511	515	522	532	597	610	625	632	698	717	727	744	839	866	893	1042	1068	1095	1239	1258
48 (122.0)	530	515	522	535	542	615	625	635	644	713	737	749	762	860	893	924	1070	1095	1132	1275	1303
54 (137.2)	538	522	535	542	546	625	635	644	658	723	753	772	785	885	915	952	1100	1132	1166	1311	1345
60 (152.4)	552	535	542	546	565	635	644	659	670	744	772	787	805	903	939	971	1132	1166	1200	1349	1381
66 (167.7)	554	537	546	565	577	644	659	670	686	760	787	805	818	926	963	996	1162	1196	1239	1389	1427
72 (182.9)	560	543	557	573	581	658	670	686	704	776	805	821	844	952	988	1029	1191	1232	1277	1427	1465
78 (198.2)	572	554	569	579	588	669	682	700	719	790	818	844	865	967	1017	1052	1224	1263	1312	1465	1508
84 (213.4)	582	565	577	588	601	681	698	717	732	808	844	864	884	988	1041	1080	1252	1300	1349	1503	1548
90 (228.6)	590	573	586	597	614	694	713	728	749	818	856	879	900	1015	1062	1112	1277	1330	1382	1545	1592
96 (243.9)	595	579	588	603	618	704	722	745	760	840	874	896	926	1032	1083	1137	1312	1359	1421	1583	1630
102 (259.1)	602	586	601	615	631	713	735	753	775	854	893	915	943	1052	1112	1162	1342	1396	1453	1621	1679
108 (274.4)	608	592	608	625	641	722	749	765	790	869	907	934	966	1075	1137	1191	1375	1426	1489	1660	1718
114 (289.6)	619	601	615	636	649	735	756	785	808	884	930	958	987	1097	1155	1218	1400	1456	1529	1714	1787
120 (304.8)	621	603	625	644	664	749	765	798	820	900	943	969	1003	1120	1187	1241	1432	1497	1557	1733	1793
126 (320.1)	630	614	636	658	672	756	787	809	831	912	962	993	1028	1139	1208	1270	1462	1526	1588	1764	1823

Template service fee: \$25 (net price)

Colors

Alabaster	112	Flax	541	Pitch Black	033	Premium Colors	
Almond	724	Forest Shadow	087	Raw Umber	006	(10% Surcharge)	
Almost White Gloss	065	Granite	044	Real Red	085	Alabaster Pearl	326
Aluminum	034	Gray Dawn	405	Rock Gray	399	Ash Metallic	126
Beige	011	Gray Haze	983	Silver	737	Beige Pearl	328
Birch White	375	Greige	122	Skyline	680	Brushed Aluminum	121
Black Satin	233	Hunter Green	154	Smokey Gray	026	Fawn Pearl	327
Buff	624	Ice	778	Snowcap White	386	Polished Aluminum	741
Burgundy	653	Lamplight	904	Stucco	963	White Pearl	637
Cameo	607	Magnet	648	Tender Taupe	103		
Char Brown	062	Matte White	042	True Blue	089		
Coconut	630	Mercury	771	True White	544		
Creamy Beige	670	Midnight Blue	057	U.N. Gray	095		
Crystal White	629	Milk Chocolate	060	Vanilla	100		
Desert Sand	625	Navajo White	376	White Gloss	005		
Fawn	031	Parchment	535	White Satin	205		

Options Pricing

Options Pricing	
Options	Surcharge
Cloth Tapes (2" (5.1 cm) Grandeur™ only)	See price charts
Bay and Corner Window	No charge
Cut-Outs	\$67
Double Slat	Double blind price
Hidden Holes™	See surcharges with price charts
Hold Down Brackets	No charge
Inverted Slats	\$20
Limited Tilt	No charge
Motorization	See motorization price list for pricing information
Multi-Colored Striped Blinds	Second color: \$25 All additional colors: \$10 Each additional blind of the same size and pattern on the same order: \$10
Multiple Blinds on One Headrail	See price charts
Premium Blind Colors	10% surcharge (add to base price)
Projection Brackets: 1¾" (4.5 cm), 2¾" (7.0 cm), 4¾" (12.1 cm) Outside Mount Only	No charge
Ring Pull/Ring Tilt	No charge
Shims ⅜" (0.5 cm)	No charge
Sky Poles	3-6½ feet (0.9 m–2.0 m) \$46, 5-9½ feet (1.5 m–2.9 m) \$70
Template Service	\$25 (net price)
Top Lock	No charge
Wood Cornices and Wood Valances	See cornice and valances price list for pricing information



Graber is a brand of Springs Window Fashions, the Best Experience Company 

Graber and the Graber logo are registered trademarks of Springs Window Fashions, LLC.

19-0750-01 (02/18) 17-7536|S17-5058