



Horizontal Blinds

- Cordless 1" Mini
- S3000 1" Mini
- Classics 1" Mini
- Customiser® 1" Mini
- S4000 Micro
- Standard Micro
- 2" Heritage™
- 2" School Blind
- Dual Headrail
- Incline Wire
- Specialty Shapes

Options & Surcharges	3
Cordless 1" Mini Blinds Price Chart	4
S3000 & Classics 1" Mini Blinds Price Chart	5
CustoMiser® 1" Mini Blinds Price Chart	6
S4000 Micro & Standard ½" Micro Blinds Price Chart	7
Heritage™ 2" Aluminum Blinds Price Chart.	8
2" Aluminum School Blinds Price Chart	9
Dual Headrail Mini Blinds for Skylights and Incline Wire Mini Blinds Price Chart	10-11
Color Coordination Charts for Incline Wire and Dual Headrail.	12
Dual Headrail and Incline Wire Blind Price Charts	13
Incline Wire Specialty Shapes: Side Cuts, Inverted Triangles, Angle Top and Bottom Price Charts	14
Incline Wire Specialty Shapes: Octagons and Triangles Price Charts.	15
Specialty Shapes: Arches Price Chart	16-17
Specialty Shapes: Circles Price Chart	18-19
Specialty Shapes: Side Cuts, Inverted Triangles, Angle Top and Bottom Price Chart	20-21
Specialty Shapes: Octagons and Triangles Price Chart.	22-23
Cut-Out Options	24
Template for Specialty Shapes.	25
Color Availability and Coordination Charts for Mini and Micro Blinds.	26-27

BLIND OPTION	CORDLESS	S3000 & CLASSICS MINI	CUSTOMISER®	S4000 & STANDARD MICRO	2" HERITAGE™ ALUMINUM	2" ALUMINUM SCHOOL BLIND	GRABER® 2" DESIGNER VINYL	CHARGES & DETAILS
Control Location:								
Tilt Left, Lift Cord Right	STD*	STD	STD	STD	STD	STD	STD	No Charge
Tilt Right, Lift Cord Left	x*	x	x	x	x	x	x	No Charge
All Controls Right	N/A	x	x	x	x	x	x	No Charge
All Controls Left	N/A	x	x	x	x	x	x	No Charge
Projection Brackets:								
1 ¾" Projection Bracket	N/A	x	x	x	N/A	N/A	N/A	
2 ¾" Projection Bracket	N/A	x	x	x	x	x	x	
4 ¾" Projection Bracket	N/A	x	x	x	x	x	x	
2" Projection Bracket	x	N/A	N/A	N/A	N/A	N/A	N/A	
3 ½" Projection Bracket	x	N/A	N/A	N/A	N/A	N/A	N/A	
Brackets								
Hidden Brackets	STD	S3000 STD N/A	N/A	S4000 STD	N/A	N/A	N/A	No Charge
Box Brackets	STD	x	STD	x	STD	STD	STD	No Charge
Turn Clips	N/A	Classics	x	STD Micro	N/A	N/A	N/A	No Charge
Direct Screw Mount	x	x	x	x	x	x		No Charge
Inverted Slat	x	x	x		x	x		\$13
Screw Options								
#8 x 5/8" Tek, combo indented hex, 4 per bag - 1 per blind	x	x	x	x	x	x	x	No Charge
#8 x 1 ¼" combo hex, 2 per bag - 2 per blind.	x	x	x	x	x	x	x	No Charge
Wand Tilt	STD	STD	STD	STD	x	x	x	No Charge
Ring Tilter	N/A	x	x	x	x	x	x	No Charge
Ring Pull	N/A	x	x	x	x	x	x	No Charge
Top Lock Cord Lock	N/A	x	x	x	N/A	N/A	N/A	No Charge
Cord Tilter	N/A	Classics	N/A	N/A	STD	STD	STD	No Charge
Tilt Limiter	N/A	x	x	x	N/A	N/A	N/A	No Charge
Perforated Slats	N/A	x	x	N/A	N/A	N/A	N/A	See price charts.
Narrow Width Blinds	N/A	See price charts						
Ladder Tapes								
Cloth Ladder Tapes	N/A	N/A	N/A	N/A	x	N/A	x	See price charts.
Vinyl Ladder Tapes	N/A	N/A	N/A	N/A	N/A	x	N/A	
Accent Channels	N/A	x	N/A	N/A	N/A	N/A	N/A	Side rails for improved privacy, available in all Classics colors (see page 26) add \$5.00/lineal foot; call Customer Service for details.
Multi-Colored Striped Blinds	x	x	N/A	x	x	N/A	N/A	\$22.00 over base price first extra color; for each additional blind of same width and color add \$8.00. Must specify all component colors required.
Double-Slatted Blinds	N/A	x	N/A	N/A	N/A	N/A	N/A	Combinations other than standard colors add 100% to blind cost. Must specify all component colors required
Cut-Outs:								
Bottom Corner	N/A	x	N/A	x	x	x	x	See page 24, add \$64.00
Bottom Center	N/A	x	N/A	x	x	x	N/A	See page 24, add \$64.00
Top Corner	N/A	x	N/A	x	x	N/A	N/A	See page 24, add \$64.00
Hold-Down Brackets	x	x	x	x	x	x	x	No charge
2 or More Blinds On One Headrail	x	x	x	x	x	x	x	2 blinds – add \$45.00; 3 blinds – add \$62.00
Telescoping Skylight Pole								
5-10 ft. pole	N/A	x	x	x	x	x	x	add \$65.00
3-6 ft. pole	N/A	x	x	x	x	x	x	add \$43.00

*Tilter only, no cord controls available

NOTE: x = Available Option



Horizontal Blinds

Cordless 1" Mini Blinds

All Available Colors – with .006 Inch Thick Slats

HEIGHT UP TO	WIDTH UP TO →																			
	23"	26"	29"	32"	36"	40"	44"	48"	52"	57"	62"	67"	72"	82"	92"	102"	112"	122"	132"	144"
42"	\$155	160	166	179	186	199	213	224	234	251	261	277	290	344	371	407	431	460	519	541
48"	158	165	177	186	198	209	223	235	247	267	278	294	308	364	397	428	455	489	548	576
54"	163	176	183	190	206	219	231	245	255	281	297	309	327	383	418	452	483	516	576	610
60"	174	182	187	205	216	226	243	255	270	295	309	327	341	402	435	478	511	544	607	640
66"	177	186	202	213	223	239	251	268	286	307	324	338	361	421	454	503	534	573	640	676
72"	182	194	207	217	234	247	264	284	297	322	338	357	380	440	480	525	564	605	670	707
78"	190	202	213	223	242	256	275	295	308	333	354	376	395	465						
84"	199	209	220	234	252	268	288	303	322	352	372	391	409							
SURCHARGE: HIDDEN HOLES																				
Hidden Holes Surcharge	8	8	8	9	11	12	12	13	13	16	16	17	19	22	23	27	28	31	34	35

NOTE: Smallest width available 18" exact. See color chart on page 26 for color availability. Not available with perforated slats. Cannot exceed 6400 sq. inches as a single blind. Due to weight limitations, blinds that fall to the right of the heavy lines must be manufactured as multiple blinds on one headrail. See guidelines below.

All Available Colors – with .008 Inch Thick Slats

HEIGHT UP TO	WIDTH UP TO →																			
	23"	26"	29"	32"	36"	40"	44"	48"	52"	57"	62"	67"	72"	82"	92"	102"	112"	122"	132"	144"
42"	\$162	166	174	189	196	209	226	237	247	265	276	294	308	364	394	431	459	489	551	573
48"	164	173	187	196	209	222	236	248	262	284	297	312	327	387	421	456	483	520	582	613
54"	171	186	193	200	219	232	244	260	270	299	316	329	349	406	445	482	515	550	614	650
60"	184	192	197	216	228	240	257	270	287	314	329	349	364	427	464	510	545	580	648	681
66"	187	196	213	225	237	253	266	285	303	327	346	361	386	448	485	538	571	615	683	723
72"	191	205	220	230	249	262	281	301	316	344	361	381	407	470	513	562	604	649	717	756
78"	200	215	225	237	257	272	293	314	328	356	378	403	421	497						
84"	210	221	234	249	268	287	307	323	345	376	398	417	440							
SURCHARGE: HIDDEN HOLES																				
Hidden Holes Surcharge	8	8	8	9	11	12	12	13	13	16	16	17	19	22	23	27	28	31	34	35

NOTE: Smallest width available 18" exact. See color chart on page 26 for color availability. Not available with perforated slats. Cannot exceed 6400 sq. inches as a single blind. Due to weight limitations, blinds that fall to the right of the heavy lines must be manufactured as multiple blinds on one headrail. See guidelines below.

Cordless Two or More Blinds on One Headrail (.006 and .008)

- Minimum blind width of individual blind – 18"
- Maximum finished blind width of individual blind – 60"
- Maximum finished blind width:
 - Two on one headrail – 120"
 - Three on one headrail – 144"
- Minimum finished blind height – 12"
- Maximum finished blind height – 72"
- Gap between blinds – 3/8"

Clearance for Cordless – 1"

Clearance is the distance from backside of slat stack to back of bracket. This allows the blind to be mounted above window frame for outside mount without projection brackets.



Used on all standard colors.

S3000 1" Mini & Classics 1" Mini Blinds

All Available Colors – with .006 Inch Thick Slats

HEIGHT UP TO	WIDTH UP TO →																				Add'l 10"	
	12"	23"	26"	29"	32"	36"	40"	44"	48"	52"	57"	62"	67"	72"	82"	92"	102"	112"	122"	132"		142"
42"	\$86	71	74	80	89	96	106	116	123	131	146	154	167	175	199	219	250	269	293	317	333	24
48"	89	74	80	91	96	108	116	126	134	144	162	171	184	194	219	245	271	293	321	346	368	28
54"	95	80	91	96	100	116	126	134	144	152	175	190	199	213	238	266	295	321	349	374	402	29
60"	106	91	96	100	115	126	134	146	154	167	190	202	217	226	257	283	321	349	376	405	431	32
66"	109	94	100	115	123	134	146	154	167	183	202	217	227	247	276	302	346	372	406	438	468	33
72"	113	98	108	120	128	144	154	167	183	194	217	231	247	266	295	328	368	402	438	468	499	36
78"	121	106	116	126	134	152	163	179	194	205	227	247	266	281	320	349	394	425	465	499	531	37
84"	130	115	123	134	144	162	175	191	202	219	247	265	281	295	338	369	417	456	496	528	563	40
90"	135	120	131	142	152	171	190	199	217	227	257	276	293	317	354	394	438	479	521	561	600	43
96"	141	126	134	146	156	183	196	213	226	245	271	290	314	330	372	414	465	503	552	592	628	44
102"	146	131	144	154	167	190	205	221	238	255	287	305	328	349	394	436	489	531	578	622	667	47
108"	153	138	150	162	175	196	217	231	250	269	298	321	346	365	414	459	515	556	607	652	700	48
114"	159	144	154	171	184	205	223	245	265	281	317	338	362	383	431	479	536	580	639	696	755	53
120"	161	146	162	179	194	217	231	255	274	293	328	349	374	402	456	500	561	612	662	711	761	53
126"	167	152	171	190	199	223	247	266	283	302	342	368	394	417	472	521	584	636	686	737	785	55
SURCHARGE: HIDDEN HOLES																						
Hidden Holes Surcharge	8	8	8	8	9	11	12	12	13	13	16	16	17	19	22	23	27	28	31	34	35	3

NOTE: Smallest width available 5½". Widths from 5½" to 8⁵/₁₆" are tilt only.
See color chart on page 26 for color availability.

All Available Colors – with .008 Inch Thick Slats

HEIGHT UP TO	WIDTH UP TO →																				Add'l 10"	
	12"	23"	26"	29"	32"	36"	40"	44"	48"	52"	57"	62"	67"	72"	82"	92"	102"	112"	122"	132"		142"
42"	\$94	79	81	88	99	106	116	130	136	144	160	169	184	194	219	242	274	297	321	349	365	28
48"	96	81	88	100	106	119	130	139	147	159	179	190	202	213	242	269	299	321	353	380	405	31
54"	103	88	100	106	110	130	139	147	159	167	194	209	219	235	261	293	325	353	383	412	442	32
60"	115	100	106	110	126	139	147	160	169	184	209	222	239	250	283	312	353	383	413	446	473	35
66"	118	103	110	126	136	147	160	169	184	200	222	239	251	271	303	333	380	409	448	481	515	36
72"	122	107	119	134	140	159	169	184	200	213	239	254	271	293	325	361	405	442	481	515	548	40
78"	131	116	130	139	147	167	180	196	213	225	251	271	293	307	352	383	434	468	512	548	584	41
84"	141	126	136	147	159	179	194	210	222	242	271	291	307	325	372	406	459	501	545	582	619	44
90"	149	134	144	155	167	190	209	219	239	251	283	303	321	349	390	434	481	527	574	618	660	47
96"	154	139	147	160	171	200	215	235	250	269	299	318	346	364	409	456	512	553	607	651	692	48
102"	159	144	159	169	184	209	225	243	261	282	316	335	361	383	434	479	539	584	635	683	734	51
108"	166	151	165	179	194	215	239	254	274	297	328	353	380	402	456	504	567	612	667	718	770	53
114"	174	159	169	190	202	225	246	269	291	307	349	372	398	421	473	527	589	639	703	766	830	59
120"	175	160	179	196	213	239	254	282	302	321	361	383	412	442	501	549	618	674	727	782	836	59
126"	182	167	190	209	219	246	271	293	312	333	376	405	434	459	519	574	644	700	755	811	864	60
SURCHARGE: HIDDEN HOLES																						
Hidden Holes Surcharge	8	8	8	8	9	11	12	12	13	13	16	16	17	19	22	23	27	28	31	34	35	3

NOTE: Smallest width available 5½". Widths from 5½" to 8⁵/₁₆" are tilt only.
See color chart on page 26 for color availability.

Perforated slat option available at 25% surcharge – .008 gauge only.

Perforated colors available: 062P Char Brown, 112P Alabaster, 121P Brushed Aluminum, 205P White Satin, 233P Black Satin

Hidden Holes available on S3000 only.



Used on all standard colors.
Not available on perforated slats.

All Available Colors – with .006 Inch Thick Slats

HEIGHT UP TO	WIDTH UP TO →																			Add'l 10"
	12"	23"	26"	29"	32"	36"	40"	44"	48"	52"	57"	62"	67"	72"	82"	92"	102"	112"	120"	
42"	\$78	63	67	74	79	88	94	99	104	115	130	136	148	154	174	192	218	236	257	22
48"	82	67	74	80	87	95	102	110	116	124	142	151	159	171	192	213	239	258	285	24
54"	89	74	80	87	91	102	110	119	128	135	152	163	174	187	209	231	261	283	307	27
60"	95	80	87	91	98	110	119	130	136	148	166	175	190	199	226	249	283	305	335	29
66"	99	84	91	98	104	119	130	136	150	158	177	191	203	217	243	269	302	328	358	31
72"	103	88	96	103	111	126	136	148	158	167	191	205	217	231	261	287	324	352	385	33
78"	109	94	102	110	119	135	146	156	167	180	203	217	231	245	277	307	343	373	408	35
84"	114	99	106	116	128	142	152	167	177	191	217	230	245	261	295	324	365	398	434	37
90"	118	103	115	124	134	150	163	175	190	202	226	243	258	277	312	342	386	421	459	39
96"	125	110	119	131	142	158	171	187	198	215	239	255	273	290	328	364	408	444	483	40
102"	130	115	126	136	148	166	180	194	209	223	253	269	287	305	343	385	428	468	511	43
108"	135	120	131	143	154	173	190	205	221	236	262	283	302	320	364	404	453	490	532	44
114"	139	124	138	151	162	183	198	217	231	249	273	295	317	333	378	420	469	513	557	45
120"	145	130	144	158	171	191	206	226	241	261	286	309	329	346	393	436	488	534	580	48
126"	149	134	152	166	180	199	217	236	251	271	297	322	342	360	408	453	505	557	604	51

NOTE: Smallest width available 5½". Widths from 5½" to 8⅝" are tilt only.
See color chart on page 26 for color availability.

All Available Colors – with .008 Inch Thick Slats

HEIGHT UP TO	WIDTH UP TO →																			Add'l 10"
	12"	23"	26"	29"	32"	36"	40"	44"	48"	52"	57"	62"	67"	72"	82"	92"	102"	112"	120"	
42"	\$86	69	74	81	87	97	103	109	114	127	143	150	163	169	191	211	240	260	283	24
48"	90	74	81	88	96	105	112	121	128	136	156	166	175	188	211	234	263	284	314	26
54"	98	81	88	96	100	112	121	131	141	149	167	179	191	206	230	254	287	311	338	30
60"	105	88	96	100	108	121	131	143	150	163	183	193	209	219	249	274	311	336	369	32
66"	109	92	100	108	114	131	143	150	165	174	195	210	223	239	267	296	332	361	394	34
72"	113	97	106	113	122	139	150	163	174	184	210	226	239	254	287	316	356	387	424	36
78"	120	103	112	121	131	149	161	172	184	198	223	239	254	270	305	338	377	410	449	39
84"	125	109	117	128	141	156	167	184	195	210	239	253	270	287	325	356	402	438	477	41
90"	130	113	127	136	147	165	179	193	209	222	249	267	284	305	343	376	425	463	505	43
96"	138	121	131	144	156	174	188	206	218	237	263	281	300	319	361	400	449	488	531	44
102"	143	127	139	150	163	183	198	213	230	245	278	296	316	336	377	424	471	515	562	47
108"	149	132	144	157	169	190	209	226	243	260	288	311	332	352	400	444	498	539	585	48
114"	153	136	152	166	178	201	218	239	254	274	300	325	349	366	416	462	516	564	613	50
120"	160	143	158	174	188	210	227	249	265	287	315	340	362	381	432	480	537	587	638	53
126"	164	147	167	183	198	219	239	260	276	298	327	354	376	396	449	498	556	613	664	56

NOTE: Smallest width available 5½". Widths from 5½" to 8⅝" are tilt only.
See color chart on page 26 for color availability.

Perforated slat option available at 25% surcharge – .008 gauge only.

Perforated colors available: 062P Char Brown, 112P Alabaster, 121P Brushed Aluminum, 205P White Satin, 233P Black Satin



Used on all standard colors.
Not available on perforated slats.

S4000 1/2" Micro & Standard 1/2" Micro Blinds

All Available Colors

HEIGHT UP TO	WIDTH UP TO →															Add'l 10"				
	12"	23"	26"	29"	32"	36"	40"	44"	48"	52"	57"	62"	67"	72"	82"		92"	102"	112"	120"
42"	\$102	87	92	98	106	122	130	140	148	159	180	190	206	218	245	271	305	333	362	31
48"	107	92	98	110	116	132	142	152	162	174	195	209	226	239	271	299	337	364	398	35
54"	113	98	110	119	124	142	154	163	177	190	210	230	245	262	293	328	365	397	432	36
60"	123	108	116	124	136	152	163	179	190	206	231	245	266	282	320	349	397	429	469	40
66"	130	115	124	136	146	163	179	190	206	219	247	265	286	303	342	378	427	461	503	41
72"	137	122	134	146	155	175	190	206	219	235	265	286	303	328	365	404	456	496	540	45
78"	145	130	142	154	163	188	203	219	235	251	283	301	328	343	390	431	485	525	575	47
84"	153	138	150	162	177	195	210	234	247	266	299	321	343	365	414	457	515	561	612	52
90"	161	146	159	173	187	206	230	243	265	281	316	339	364	389	438	483	547	593	646	53
96"	167	152	163	183	195	219	239	258	276	297	333	358	385	409	463	511	575	623	679	56
102"	175	160	175	190	206	231	251	270	291	310	352	374	404	429	485	537	603	658	717	59
108"	181	166	183	198	215	242	265	286	307	328	365	394	425	452	511	565	632	690	750	62

NOTE: Smallest width available 5 1/2". Widths from 5 1/2" to 8 15/16" are tilt only.
See color chart on page 26 for color availability.



Used on all standard colors.

HEIGHT UP TO	WIDTH UP TO →																				
	12"	23"	26"	29"	32"	36"	40"	44"	48"	52"	57"	62"	67"	72"	82"	92"	102"	112"	122"	132"	142"
42"	\$106	91	96	103	112	126	135	146	154	167	188	199	215	225	253	282	317	343	374	404	428
48"	111	96	103	116	124	138	150	159	171	183	205	219	235	249	282	309	347	376	413	441	469
54"	118	103	116	124	132	150	159	173	186	196	222	241	253	270	305	338	378	413	449	481	515
60"	130	115	124	132	143	159	173	188	199	217	242	255	276	291	330	362	413	446	488	520	556
66"	135	120	131	143	154	173	188	199	218	230	258	277	295	316	356	393	441	477	521	560	597
72"	143	128	140	152	162	184	198	217	230	245	277	299	316	338	378	420	471	515	560	599	640
78"	150	135	150	159	173	196	213	227	245	262	295	316	338	358	405	446	501	547	596	640	682
84"	159	144	155	171	186	205	222	243	258	277	314	337	358	378	431	472	531	580	631	678	722
90"	167	152	167	180	194	218	241	254	276	293	330	356	376	402	456	501	564	615	667	718	767
96"	174	159	173	190	205	230	249	270	289	312	347	373	398	424	479	528	596	648	704	754	810
102"	184	169	184	198	217	242	262	283	305	326	368	394	420	446	503	560	623	682	744	799	850
108"	189	174	191	206	225	251	276	299	321	343	381	413	441	467	528	588	656	712	778	836	893
114"	199	184	199	218	235	265	289	314	337	358	402	431	463	489	556	615	687	748	817	877	932
120"	205	190	206	226	245	276	299	324	349	373	420	449	481	513	580	643	719	782	855	916	975
126"	211	196	218	239	254	289	314	339	364	393	438	467	501	532	603	667	748	813	893	953	1016

NOTE: Smallest width available 9". Blinds from 9" to 11⁵/₁₆" are center tilt only.

Colors

Alabaster 112	Black Satin 233	Dark Bronze 168	Raw Umber 006
Alabaster Pearl 326	Brushed Aluminum . . . 121	Gray Haze 983	Snowcap White 386
Almond 724	Burgundy 653	Greige 122	Stucco 963
Almost White Gloss . . 065	Char Brown 062	Hunter Green 154	True White 544
Ash Metallic 126	Creamy Beige 670	Lamplight 904	White Gloss 005
		Polished Aluminum . . . 741	White Satin 205

With Cloth Tapes

HEIGHT UP TO	WIDTH UP TO →																				
	12"	23"	26"	29"	32"	36"	40"	44"	48"	52"	57"	62"	67"	72"	82"	92"	102"	112"	122"	132"	142"
42"	\$120	105	110	118	129	145	155	168	177	192	216	229	247	259	291	324	365	394	430	465	492
48"	125	110	118	133	143	159	173	183	197	210	236	252	270	286	324	355	399	432	475	507	539
54"	133	118	133	143	152	173	183	199	214	225	255	277	291	311	351	389	435	475	516	553	592
60"	147	132	143	152	164	183	199	216	229	250	278	293	317	335	380	416	475	513	561	598	639
66"	153	138	151	164	177	199	216	229	251	265	297	319	339	363	409	452	507	549	599	644	687
72"	162	147	161	175	186	212	228	250	265	282	319	344	363	389	435	483	542	592	644	689	736
78"	170	155	173	183	199	225	245	261	282	301	339	363	389	412	466	513	576	629	685	736	784
84"	181	166	178	197	214	236	255	279	297	319	361	388	412	435	496	543	611	667	726	780	830
90"	190	175	192	207	223	251	277	292	317	337	380	409	432	462	524	576	649	707	767	826	882
96"	198	183	199	219	236	265	286	311	332	359	399	429	458	488	551	607	685	745	810	867	932
102"	209	194	212	228	250	278	301	325	351	375	423	453	483	513	578	644	716	784	856	919	978
108"	215	200	220	237	259	289	317	344	369	394	438	475	507	537	607	676	754	819	895	961	1027
114"	227	212	229	251	270	305	332	361	388	412	462	496	532	562	639	707	790	860	940	1009	1072
120"	234	219	237	260	282	317	344	373	401	429	483	516	553	590	667	739	827	899	983	1053	1121
126"	240	225	251	275	292	332	361	390	419	452	504	537	576	612	693	767	860	935	1027	1096	1168

1½" Cloth Tape

Beige 2011	Duck White 2136	Moss 2500	Wheat 2710
Black 2033	Forest 2234	Navy 2369	White 2005
Chocolate 2353	Light Beige 2137	Taupe 2659	White Smoke 2617
Cocoa 2297	Maroon 2360	Toffee 2296	



Used on all standard colors.

Horizontal Blinds



2" Aluminum School Blind

HEIGHT UP TO	WIDTH UP TO →																				
	12"	23"	26"	29"	32"	36"	40"	44"	48"	52"	57"	62"	67"	72"	82"	92"	102"	112"	122"	132"	142"
42"	120	105	110	118	129	145	155	168	177	192	216	229	247	259	291	324	365	394	430	465	492
48"	125	110	118	133	143	159	173	183	197	210	236	252	270	286	324	355	399	432	475	507	539
54"	133	118	133	143	152	173	183	199	214	225	255	277	291	311	351	389	435	475	516	553	592
60"	147	132	143	152	164	183	199	216	229	250	278	293	317	335	380	416	475	513	561	598	639
66"	153	138	151	164	177	199	216	229	251	265	297	319	339	363	409	452	507	549	599	644	687
72"	162	147	161	175	186	212	228	250	265	282	319	344	363	389	435	483	542	592	644	689	736
78"	170	155	173	183	199	225	245	261	282	301	339	363	389	412	466	513	576	629	685	736	784
84"	181	166	178	197	214	236	255	279	297	319	361	388	412	435	496	543	611	667	726	780	830
90"	190	175	192	207	223	251	277	292	317	337	380	409	432	462	524	576	649	707	767	826	882
96"	198	183	199	219	236	265	286	311	332	359	399	429	458	488	551	607	685	745	810	867	932
102"	209	194	212	228	250	278	301	325	351	375	423	453	483	513	578	644	716	784	856	919	978
108"	215	200	220	237	259	289	317	344	369	394	438	475	507	537	607	676	754	819	895	961	1027
114"	227	212	229	251	270	305	332	361	388	412	462	496	532	562	639	707	790	860	940	1009	1072
120"	234	219	237	260	282	317	344	373	401	429	483	516	553	590	667	739	827	899	983	1053	1121
126"	240	225	251	275	292	332	361	390	419	452	504	537	576	612	693	767	860	935	1027	1096	1168

NOTE: Smallest width available 9". Blinds from 9" to 11^{15/16}" are center tilt only.

Colors

Alabaster 112
 Almond 724
 Brushed Aluminum 121
 Char Brown 062
 Creamy Beige 670
 Gray Haze 983

Lamplight 904
 Polished Aluminum 741
 Snowcap White 386
 White Gloss 005
 White Satin 205

1½" Vinyl Ladder Tape

Char Brown 062
 Creamy Beige 670
 Gray Haze 983

Lamplight 904
 White 005

Dual Headrail Features

- For windows at more than a 45 degree angle
- Blinds are tilt only
- Choose .006 or .008 gauge 1" aluminum slat
- 1" x 1½" steel headrail, box design
- Ring tilt left (standard) or right
- Color-coordinated components provide a finished look (see page 12)
- Multi-colored striped blinds (see page 3)
- Skypoles available for easy tilting (see page 3)

Dual Headrail Skylight

Ideal for skylights at more than a 45 degree angle.

NOTE: Blind is tilt only, no lift.

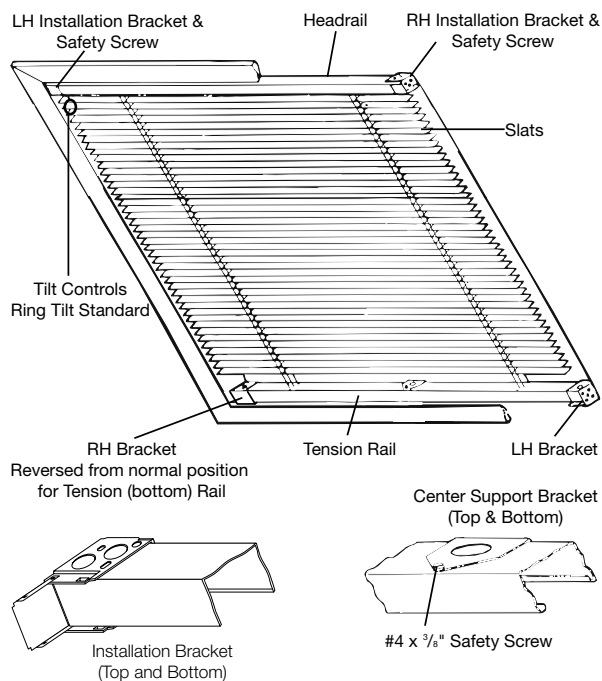

How to Measure

Inside Mount

Measure precise width and height dimensions and specify this as an "opening size, make allowance". Do not deduct for headrail clearance gaps. Manufacturer will make all allowances for both width and height. Headrail, tension rail and slats will be manufactured ½" less than the dimension given as width. Proper deductions will be made for blind height.

Outside Mount

Measure width and height dimensions and specify as "blind size, cut exact". The manufacturer will not make any allowances for width or height. Headrail, tension rail and slats will equal dimensions given as width. Blind height will refer to the distance from the top of the upper bracket to the lower bracket of the installed blind and will equal dimension given as height. Do not deduct for headrail and tension rail clearance gaps.

Dual Headrail Component Diagram

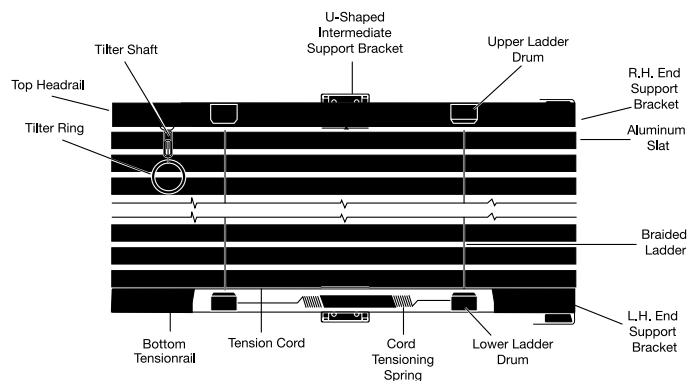

TILT ONLY - NO LIFT

NOTE: Blind height may measure shorter than order states due to the cord tension spring. Proper installation will increase tension and lengthen the blind to completely cover your window opening.

Size Specifications

		Dual Headrail	
Minimum Width	9"		
Maximum Width	142"		
Minimum Height	10"		
Maximum Height	Blind Width	Max Height	
	9" - 23"	126"	
	23 1/8" - 32"	102"	
	32 1/8" - 72"	90"	
	72 1/8" - 142"	80"	

Incline Wire Features

- Degree from vertical cannot exceed 45 degrees
- Choose .006 or .008 gauge 1" aluminum slat
- 1" x 1½" steel headrail, box design
- Torque wand tilter with clear wand
- Wand tilt left (standard) or right
- Durable polyester lift cord
- Lift cord right (standard) or left
- Cord bead stops
- Almost invisible braided polyester support ladders
- Color-coordinated components provide a finished look (see page 12)
- Sky poles available for easy tilting upon request (see page 3)
- Multi-colored striped blinds (see page 3)
- Double-slatted blinds (see page 3)
- Ring tilt may be substituted for wand
- Ring pull is an option

How to Measure

Inside Mount

Measure precise width and height dimensions and specify this as an "opening size, make allowance". Do not deduct for headrail clearance gaps. Manufacturer will make all allowances for both width and height. Headrail, tension rail and slats will be manufactured ½" less than the dimension given as width. Proper deductions will be made for blind height.

Outside Mount

Measure width and height dimensions and specify as "blind size, cut exact". The manufacturer will not make any allowances for width or height. Headrail, tension rail and slats will equal dimensions given as width. Blind height will refer to the distance from the top of the upper bracket to the lower bracket of the installed blind and will equal dimension given as height. Do not deduct for headrail and tension rail clearance gaps.

NOT RECOMMENDED FOR INSTALLATIONS GREATER THAN 45° FROM VERTICAL

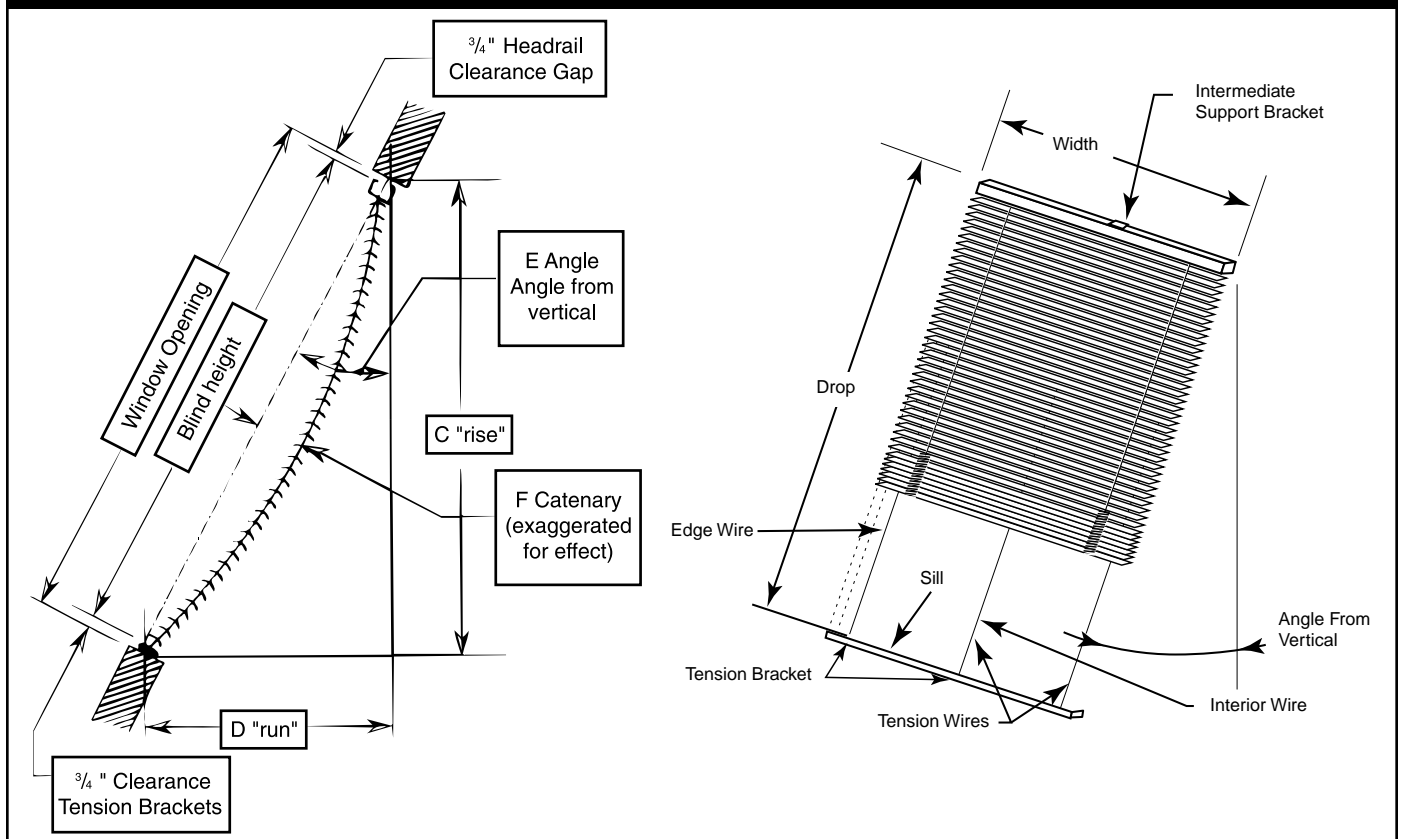

Size Specifications

		Incline Wire	
Minimum Width	9" exact		
Maximum Width	122"		
Minimum Height	10"		
Maximum Height	Blind Width	Max Height	
	9" - 32"	126"	
	32½" - 57"	108"	
	57½" - 92"	102"	
	92½" - 122"	90"	

Skylight Blinds: Incline Wire and Dual Headrail

The Bali Skylight blind uses a specially constructed ladder designed for the interlacing of slats. The five ladder colors offered will coordinate with many slat colors.

Interlacing Ladder Color	Slat Color Examples					
Char Brown #062	Char Brown	062	Milk Chocolate	060	Tender Taupe	103
	Granite	044	Raw Umber	006		
Smokey Gray #026	Aluminum	034	Greige	122	Skyline	680
	Black Satin	233	Pitch Black	033	Smokey Gray	026
	Brushed Aluminum	121	Polished Aluminum	741	Stucco	963
	Gray Dawn	405	Rock Gray	399	UN Gray	095
	Gray Haze	983	Silver	737		
Fawn #031	Buff	624	Desert Sand	625	Lamplight	904
	Cameo	607	Fawn	031		
	Creamy Beige	670	Fawn Pearl	327		
White Gloss #005	Burgundy	653	Magnet	648	True Blue	089
	Coconut	630	Mercury	771	True White	544
	Crystal White	629	Midnight Blue	057	White Gloss	005
	Forest Shadow	087	Navajo White	376	White Satin	205
	Hunter Green	154	Real Red	085	White Pearl	637
	Ice	778	Snowcap White	386		
Alabaster #112	Alabaster	112	Ash Metallic	126	Flax	541
	Alabaster Pearl	326	Beige	011	Matte White	042
	Almond	724	Beige Pearl	328	Parchment	535
	Almost White Gloss	065	Birch White	375	Vanilla	100

.006 Gauge

HEIGHT UP TO	WIDTH UP TO →																				
	12"	23"	26"	29"	32"	36"	40"	44"	48"	52"	57"	62"	67"	72"	82"	92"	102"	112"	122"	132"	142"
42"	\$182	167	179	184	194	241	250	257	267	274	321	342	358	368	429	456	497	521	549	593	636
48"	194	179	188	194	203	254	265	273	283	293	342	365	378	394	464	492	534	565	591	639	686
54"	199	184	196	203	215	269	281	289	299	309	365	389	402	420	497	523	571	603	632	685	737
60"	207	192	203	213	225	283	295	303	316	326	385	412	428	441	523	559	612	646	676	733	789
66"	214	199	215	222	236	297	307	320	333	346	408	434	456	469	561	593	652	686	722	781	840
72"	224	209	223	234	247	309	322	335	349	364	428	459	479	496	575	626	692	725	765	826	888
78"	234	219	235	245	261	326	338	350	364	372	457	488	507	529	627	670	743	782	819	885	952
84"	240	225	242	253	269	335	350	369	381	396	469	503	525	547	652	695	766	810	851		
90"	249	234	253	262	281	350	369	383	397	413	492	525	552	571	685	726	806	850	897		
96"	256	241	261	271	290	365	381	397	413	431	515	549	575	596	715	763					
102"	265	250	270	283	301	380	396	413	434	452	534	571	597	600	747	797					
108"	270	255	277	290	310	393	409	429	449	467	556										
114"	281	266	289	301	322																
120"	288	273	295	309	334																
126"	298	283	303	320	346																

Incline wire available only in sizes to the left of the dotted line.

Dual Headrail available only in sizes above the heavy line.

.008 Gauge

HEIGHT UP TO	WIDTH UP TO →																				
	12"	23"	26"	29"	32"	36"	40"	44"	48"	52"	57"	62"	67"	72"	82"	92"	102"	112"	122"	132"	142"
42"	\$199	184	196	202	213	265	274	283	295	302	353	376	394	405	472	501	547	574	604	652	700
48"	211	196	207	213	223	281	291	301	312	321	376	402	417	434	511	541	588	622	650	703	755
54"	217	202	215	223	238	297	307	317	329	341	402	427	442	463	547	575	628	663	696	754	811
60"	226	211	223	235	247	312	325	334	347	360	423	453	471	485	575	615	674	710	744	806	869
66"	234	219	238	245	259	326	338	352	365	380	449	477	501	516	618	652	718	755	795	859	924
72"	245	230	246	257	271	341	356	368	383	401	471	504	527	545	632	690	761	798	842	909	977
78"	257	242	258	269	287	360	372	386	401	409	503	537	557	583	691	737	817	861	902	975	1047
84"	262	247	266	277	297	368	386	406	420	436	516	553	578	601	718	765	843	890	936		
90"	272	257	277	289	307	386	406	421	437	454	541	578	607	628	754	799	886	935	985		
96"	280	265	287	299	318	402	420	437	454	473	567	604	632	655	786	840					
102"	289	274	298	312	330	418	436	454	477	497	588	628	658	660	821	876					
108"	297	282	305	318	342	432	450	472	495	513	612										
114"	308	293	317	330	356																
120"	316	301	325	341	366																
126"	327	312	334	352	380																

Incline wire available only in sizes to the left of the dotted line.

Dual Headrail available only in sizes above the heavy line.



Horizontal Blinds

Incline Wire Specialty Shapes: Side Cuts

Angle Tops and Bottoms

.006 Gauge

HEIGHT UP TO ↓	WIDTH UP TO →																		
	12"	23"	26"	29"	32"	36"	40"	44"	48"	52"	57"	62"	67"	72"	82"	92"	102"	112"	122"
42"	\$463	448	459	464	473	553	563	570	580	620	667	687	704	755	817	843	950	975	1002
48"	474	459	468	473	483	567	578	587	596	639	687	711	725	781	851	878	987	1019	1043
54"	479	464	476	483	496	582	593	601	612	655	711	734	748	807	884	910	1024	1056	1086
60"	487	472	483	493	505	596	608	616	628	672	730	758	774	828	910	946	1065	1099	1130
66"	494	479	496	503	516	610	620	632	646	692	754	779	802	857	949	980	1105	1139	1175
72"	504	489	504	513	527	622	635	648	662	710	774	805	825	882	962	1013	1144	1178	1218
78"	515	500	515	524	541	640	651	663	676	718	803	833	853	917	1015	1057	1195	1235	1273
84"	520	505	521	532	549	648	663	682	695	742	815	849	872	933	1039	1082	1219	1263	1305
90"	528	513	532	543	560	663	682	696	710	759	837	872	898	958	1072	1113	1259	1303	1349
96"	535	520	541	552	570	678	695	710	726	777	861	895	921	983	1103	1151			
102"	544	529	551	563	580	694	708	726	747	798	880	917	944	987	1134	1183			
108"	551	536	557	570	591	706	722	743	762	813	902								
114"	562	547	568	580	603														
120"	568	553	575	589	614														
126"	578	563	583	600	626														

.008 Gauge

HEIGHT UP TO ↓	WIDTH UP TO →																		
	12"	23"	26"	29"	32"	36"	40"	44"	48"	52"	57"	62"	67"	72"	82"	92"	102"	112"	122"
42"	\$479	464	476	481	493	578	588	596	608	648	699	722	740	793	859	888	1000	1027	1057
48"	491	476	488	493	504	593	604	614	624	667	722	748	763	821	898	932	1040	1075	1103
54"	496	481	496	504	517	610	620	630	643	686	748	773	788	850	933	962	1082	1116	1149
60"	507	492	504	515	527	624	639	647	660	706	769	799	817	872	962	1002	1127	1163	1197
66"	515	500	517	524	540	640	651	664	678	726	795	824	847	904	1005	1039	1171	1208	1247
72"	524	509	525	537	552	654	668	681	696	747	817	850	873	932	1020	1076	1214	1251	1294
78"	536	521	539	549	567	672	685	699	714	755	849	882	904	971	1077	1124	1270	1314	1355
84"	542	527	547	557	576	681	699	719	733	781	862	900	924	988	1105	1152	1295	1344	1389
90"	552	537	557	568	588	699	719	734	750	801	886	924	953	1016	1140	1186	1340	1388	1438
96"	560	545	567	579	599	715	733	750	767	819	913	950	979	1041	1174	1227			
102"	570	555	578	592	611	731	748	767	791	843	933	975	1004	1048	1208	1263			
108"	576	561	584	599	622	746	763	785	807	859	958								
114"	587	572	597	611	635														
120"	595	580	606	620	647														
126"	607	592	614	631	660														

Incline Wire Specialty Shapes: Octagons, Triangles and Other Shapes

.006 Gauge

HEIGHT UP TO	WIDTH UP TO →																		
	12"	23"	26"	29"	32"	36"	40"	44"	48"	52"	57"	62"	67"	72"	82"	92"	102"	112"	122"
42"	554	539	549	555	564	660	670	676	687	744	791	811	828	912	973	1000	1139	1164	1191
48"	564	549	559	564	574	674	685	694	703	762	811	834	849	937	1008	1035	1176	1208	1233
54"	570	555	567	574	587	690	700	708	719	778	834	858	872	964	1040	1067	1214	1245	1275
60"	578	563	574	583	596	703	715	723	735	797	854	881	898	984	1067	1103	1255	1287	1319
66"	585	570	587	593	607	717	727	740	753	815	877	904	925	1013	1105	1136	1294	1329	1365
72"	594	579	595	604	618	729	743	755	769	833	898	928	949	1039	1119	1170	1334	1367	1407
78"	606	591	606	615	631	747	758	770	783	842	926	957	976	1073	1171	1214	1385	1425	1462
84"	611	596	612	623	640	755	770	789	802	865	939	972	996	1090	1195	1238	1409	1452	1493
90"	619	604	623	632	651	770	789	803	817	882	961	996	1021	1115	1229	1270	1448	1492	1539
96"	626	611	631	643	660	785	802	817	833	901	984	1019	1044	1139	1259	1307			
102"	635	620	642	654	671	801	815	833	854	921	1004	1040	1067	1143	1290	1340			
108"	641	626	648	660	681	813	829	850	869	936	1025								
114"	651	636	659	671	694														
120"	659	644	666	679	704														
126"	669	654	674	691	717														

.008 Gauge

HEIGHT UP TO	WIDTH UP TO →																		
	12"	23"	26"	29"	32"	36"	40"	44"	48"	52"	57"	62"	67"	72"	82"	92"	102"	112"	122"
42"	570	555	567	572	583	685	695	703	715	771	822	846	864	949	1016	1044	1188	1216	1246
48"	582	567	578	583	595	700	711	721	731	791	846	872	886	977	1055	1084	1230	1265	1291
54"	587	572	587	595	608	717	727	737	750	810	872	897	912	1006	1090	1119	1271	1306	1338
60"	597	582	595	606	618	731	746	754	767	829	893	922	940	1028	1119	1159	1317	1353	1386
66"	606	591	608	615	630	747	758	771	785	850	918	948	971	1060	1162	1195	1361	1397	1437
72"	615	600	616	627	643	761	775	788	803	870	940	973	997	1088	1176	1233	1403	1440	1484
78"	627	612	628	640	658	779	793	806	821	878	972	1006	1027	1127	1234	1281	1460	1503	1544
84"	633	618	636	648	667	788	806	826	840	905	985	1023	1048	1144	1262	1309	1485	1533	1579
90"	642	627	648	659	678	806	826	842	857	924	1011	1048	1076	1172	1297	1342	1529	1577	1628
96"	650	635	658	670	690	822	840	857	874	944	1036	1073	1103	1199	1330	1384			
102"	661	646	668	682	702	838	855	874	898	966	1057	1099	1127	1204	1365	1420			
108"	667	652	675	690	712	853	870	893	914	983	1082								
114"	678	663	687	702	726														
120"	686	671	696	711	737														
126"	697	682	704	722	751														

Features

- Choose .006 or .008 gauge 1" aluminum slat
- Use 1" x 1" aluminum headrail
- Valance not available
- A template is required for all arches except Perfect Arches
- Limitations may apply within each blind type. Fax a drawing to Customer Service to determine availability
- May require 4-6 weeks lead time to manufacture
- Available in all Classics colors (see page 26)

Size Considerations

	Arches	Quarter Arch
Minimum Width	10"	12¾"
Maximum Width	Base 142"	142"
Minimum Height	5"	6"
Maximum Height	170"	170"

Controls

Arches: Standard, Reverse or Same Side

Quarter Arch: Low Side

Full Tilt: Lift depends on shape

Top Lock Cord Lock, Cord Tilt, Ring Tilt and

Turn Clips: Not Available

Arches

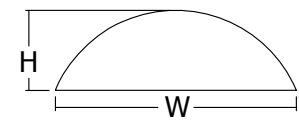
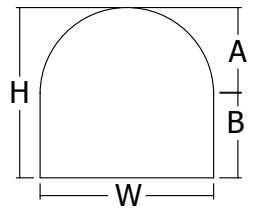
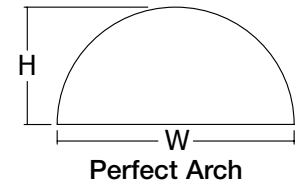
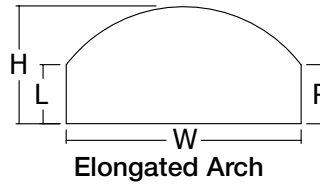

Quarter Arches

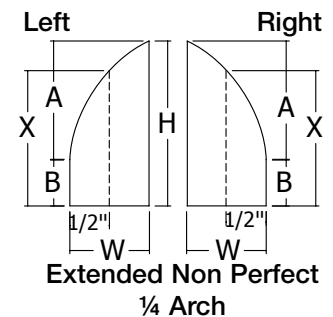
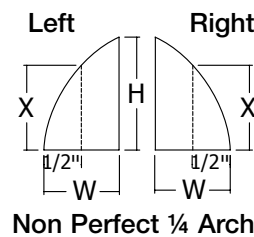
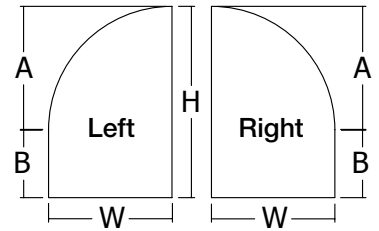
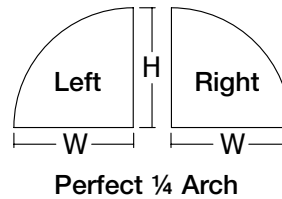

1" Slats .006 Gauge

HEIGHT UP TO ↓	WIDTH UP TO →																				
	12"	23"	26"	29"	32"	36"	40"	44"	48"	52"	57"	62"	67"	72"	82"	92"	102"	112"	122"	132"	142"
42"	\$651	636	640	646	655	662	671	682	774	781	797	805	818	826	850	870	932	952	1004	1028	1043
48"	753	738	744	755	761	773	781	791	830	842	859	869	881	922	949	973	1035	1056	1118	1142	1164
54"	828	813	824	829	833	850	859	866	910	918	941	956	965	1011	1035	1064	1127	1154	1214	1239	1267
60"	908	893	898	902	917	928	935	948	988	1002	1024	1036	1052	1092	1123	1149	1222	1250	1310	1338	1365
66"	977	962	969	984	992	1002	1015	1023	1069	1084	1104	1119	1130	1180	1210	1235	1314	1340	1407	1438	1469
72"	1105	1090	1101	1113	1120	1136	1146	1160	1184	1195	1219	1233	1250	1269	1297	1330	1492	1527	1575	1604	1635
78"	1182	1167	1178	1187	1194	1214	1224	1239	1265	1275	1298	1318	1337	1350	1390	1420	1587	1619	1671	1703	1736
84"	1260	1245	1254	1263	1274	1291	1306	1321	1341	1359	1386	1405	1420	1434	1477	1509	1679	1718	1770	1802	1837
90"	1266	1251	1260	1271	1282	1302	1319	1329	1357	1367	1396	1416	1432	1457	1493	1533	1699	1741	1795	1835	1874
96"	1271	1256	1263	1275	1286	1313	1326	1342	1366	1384	1412	1429	1454	1470	1512	1553	1727	1764	1826	1866	1902
102"	1275	1260	1274	1283	1297	1319	1334	1350	1377	1394	1426	1444	1468	1488	1533	1575	1750	1793	1852	1896	1941
108"	1282	1267	1279	1291	1306	1326	1346	1361	1389	1409	1437	1461	1485	1505	1553	1598	1777	1818	1881	1926	1974
114"	1289	1274	1283	1302	1314	1334	1354	1374	1405	1420	1457	1477	1501	1523	1571	1619	1797	1842	1913	1970	2029
120"	1290	1275	1291	1309	1323	1346	1361	1385	1414	1432	1468	1488	1514	1541	1595	1639	1823	1874	1936	1985	2035
126"	1297	1282	1302	1319	1329	1354	1377	1396	1422	1441	1481	1508	1533	1557	1612	1661	1846	1898	1960	2011	2059

1" Slats .008 Gauge

HEIGHT UP TO ↓	WIDTH UP TO →																				
	12"	23"	26"	29"	32"	36"	40"	44"	48"	52"	57"	62"	67"	72"	82"	92"	102"	112"	122"	132"	142"
42"	\$659	644	647	654	664	671	682	695	786	795	811	819	834	845	870	893	957	979	1032	1060	1076
48"	761	746	753	765	770	783	794	803	845	857	876	886	900	941	971	998	1063	1084	1149	1176	1202
54"	836	821	833	838	843	862	872	880	925	933	960	975	985	1032	1059	1090	1158	1184	1247	1277	1307
60"	917	902	908	912	928	940	949	962	1004	1019	1043	1057	1073	1116	1149	1178	1254	1283	1346	1380	1407
66"	987	972	979	996	1005	1016	1029	1037	1086	1103	1124	1140	1154	1206	1237	1266	1348	1377	1448	1483	1516
72"	1115	1100	1112	1126	1132	1152	1162	1176	1203	1215	1241	1256	1274	1294	1327	1363	1529	1567	1619	1651	1684
78"	1193	1178	1190	1200	1208	1229	1241	1258	1283	1295	1322	1342	1363	1378	1422	1454	1627	1661	1718	1753	1790
84"	1271	1256	1266	1277	1289	1309	1323	1340	1362	1381	1412	1430	1447	1465	1512	1545	1720	1763	1819	1856	1893
90"	1278	1263	1274	1285	1297	1319	1338	1349	1378	1390	1422	1442	1461	1488	1529	1573	1743	1789	1847	1892	1933
96"	1284	1269	1277	1290	1302	1330	1345	1365	1389	1409	1438	1458	1485	1503	1548	1595	1774	1815	1881	1925	1966
102"	1289	1274	1289	1298	1314	1338	1355	1373	1400	1421	1456	1474	1500	1523	1573	1619	1799	1846	1909	1957	2008
108"	1296	1281	1294	1309	1323	1345	1369	1384	1414	1436	1468	1492	1520	1541	1595	1643	1829	1874	1941	1992	2044
114"	1304	1289	1298	1319	1331	1355	1376	1398	1430	1447	1488	1512	1537	1561	1613	1667	1850	1900	1977	2040	2104
120"	1305	1290	1309	1326	1342	1369	1384	1412	1441	1461	1500	1523	1551	1581	1640	1688	1879	1936	2001	2056	2110
126"	1312	1297	1319	1338	1349	1376	1401	1422	1451	1472	1516	1544	1573	1598	1659	1714	1905	1961	2029	2085	2137

Features

- Choose .006 or .008 gauge 1" aluminum slat
- An illustration can be resized
- Use 1" x 1" aluminum headrail
- Valance not available
- A template is required for all non perfect circles
- Limitations may apply within each blind type. Fax a drawing to Customer Service to determine availability
- May require up to 4-6 weeks lead time to manufacture
- Available in all Classics colors (see page 26)

Size Considerations

Minimum Width	12" diameter
Maximum Width	72"

Controls

Controls: Left or Right

Full tilt: no lift

Top Lock Cord Lock, Cord Tilt, Ring Tilt and

Turn Clips: Not Available

Circles

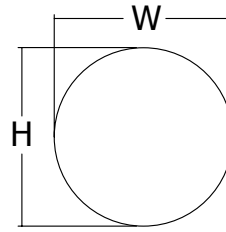

Full Circle

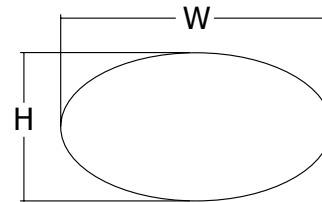

Non Perfect Circle

To price use larger number for width.

1" Slats .006 Gauge

HEIGHT UP TO ↓	WIDTH UP TO →													
	12"	23"	26"	29"	32"	36"	40"	44"	48"	52"	57"	62"	67"	72"
42"	\$619	604	654	707	763	833	906	980	1059	1128	1223	1310	1401	1489
48"	622	607	659	718	770	846	917	989	1068	1142	1239	1327	1418	1508
54"	627	612	670	723	774	854	926	997	1079	1151	1254	1345	1433	1527
60"	638	623	675	727	789	864	933	1009	1088	1166	1267	1358	1451	1540
66"	641	626	679	743	798	870	946	1017	1103	1180	1279	1373	1462	1561
72"	645	630	687	748	802	881	954	1031	1118	1191	1294	1386	1481	1580

1" Slats .008 Gauge

HEIGHT UP TO ↓	WIDTH UP TO →													
	12"	23"	26"	29"	32"	36"	40"	44"	48"	52"	57"	62"	67"	72"
42"	\$626	611	660	715	773	843	917	992	1071	1142	1238	1325	1418	1508
48"	629	614	667	727	779	857	929	1002	1082	1158	1256	1345	1436	1527
54"	635	620	679	733	783	866	939	1011	1094	1166	1271	1365	1454	1548
60"	647	632	685	737	801	876	948	1024	1104	1182	1286	1378	1473	1564
66"	650	635	690	754	810	884	961	1032	1119	1199	1301	1394	1485	1585
72"	655	640	699	761	814	897	969	1048	1135	1211	1317	1410	1506	1607

Features

- Choose .006 or .008 gauge 1" aluminum slat
- An illustration can be inverted or reversed or resized
- Use 1" x 1½" steel headrail
- Valance not available
- Limitations may apply within each blind type. Fax a drawing to Customer Service to determine availability.
- May require up to 2-4 weeks lead time to manufacture
- To order, fax a signed drawing with all dimensions to customer service.
- Available as Incline Wire for Skylights (see page 11)
- Available in all Classics colors (see page 26)

Controls

- Side Cuts: Standard, Reverse or Same Side (straight side only)
- Angle Bottoms: Standard, Reverse or Same Side (dependent on shape)
- Angle Tops & Bottoms: Cord Lock must be Low Side
- Full Tilt: Lift depends on shape
- Cord Tilt: not available
- Top Lock Cord Lock: not available
- Angle Bottoms: Bottom point will have light gap, 60° maximum angle degree

Size Considerations

	Side Cuts	Angle Top and Bottom
Minimum Bottom Rail	4½" Exact	12" Exact
Maximum Width	142"	142"
Minimum Height	6"	6"
Maximum Height	126"	126"

Side cuts, triangles, angle top and bottom

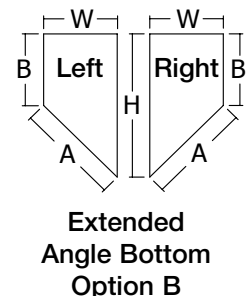
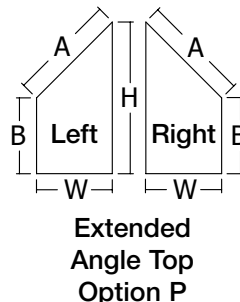
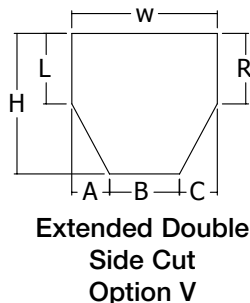
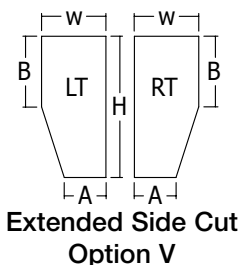
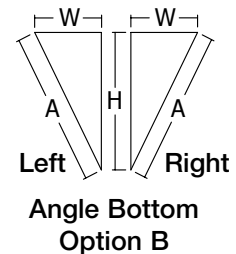
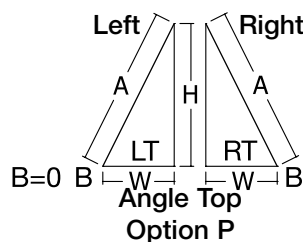
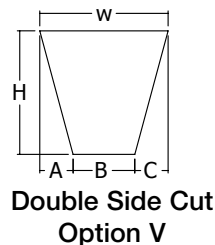
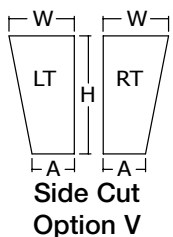

1" Slats .006 Gauge

HEIGHT UP TO ↓	WIDTH UP TO →																				
	12"	23"	26"	29"	32"	36"	40"	44"	48"	52"	57"	62"	67"	72"	82"	92"	102"	112"	122"	132"	142"
42"	\$367	352	354	360	369	409	418	429	437	476	492	500	513	563	587	607	703	722	746	861	876
48"	369	354	360	370	376	421	429	440	446	490	508	517	529	580	607	631	725	746	774	889	912
54"	375	360	370	376	380	429	440	446	457	499	521	536	545	600	624	654	748	774	802	918	946
60"	385	370	376	380	396	440	446	459	467	513	536	548	563	614	644	670	774	802	829	949	975
66"	388	373	380	396	404	446	459	467	480	528	548	563	574	634	663	690	799	825	859	981	1012
72"	392	377	389	401	408	457	467	480	496	540	563	576	593	654	682	715	821	855	890	1012	1041
78"	401	386	397	406	413	465	476	492	507	551	574	593	612	667	707	735	847	878	918	1041	1075
84"	411	396	404	413	424	475	489	504	515	565	593	611	626	682	725	757	870	909	949	1072	1107
90"	416	401	410	421	432	485	503	512	529	574	603	622	639	704	742	781	890	932	975	1105	1143
96"	421	406	413	425	437	496	509	525	540	591	618	635	660	718	759	802	918	956	1005	1135	1172
102"	425	410	424	434	448	503	517	534	551	601	632	651	674	735	781	822	941	984	1031	1166	1211
108"	432	417	429	442	456	509	529	544	563	615	644	667	692	753	802	846	968	1009	1060	1195	1243
114"	439	424	434	452	464	517	537	557	578	626	663	683	708	770	818	866	988	1033	1091	1239	1298
120"	440	425	442	459	473	529	544	568	588	639	674	695	721	789	843	886	1015	1065	1115	1255	1305
126"	447	432	452	469	479	537	560	579	596	648	687	714	740	805	859	909	1037	1090	1139	1281	1329

1" Slats .008 Gauge

HEIGHT UP TO ↓	WIDTH UP TO →																				
	12"	23"	26"	29"	32"	36"	40"	44"	48"	52"	57"	62"	67"	72"	82"	92"	102"	112"	122"	132"	142"
42"	\$373	358	361	368	378	418	429	442	449	490	507	515	529	580	607	628	727	750	774	893	909
48"	376	361	368	380	386	432	442	452	460	505	524	536	548	600	628	656	753	774	806	924	949
54"	383	368	380	386	390	442	452	460	472	513	540	555	565	622	648	679	778	806	836	956	985
60"	395	380	386	390	406	452	460	473	481	529	555	568	584	636	670	699	806	836	866	989	1017
66"	398	383	390	406	416	460	473	481	497	547	568	584	597	659	691	719	833	862	901	1025	1059
72"	403	388	400	413	420	472	481	497	513	559	584	600	618	679	712	748	858	895	935	1059	1091
78"	412	397	409	418	427	480	493	509	525	571	597	618	639	695	738	770	886	921	965	1091	1128
84"	421	406	416	427	440	492	507	523	536	588	618	636	654	712	759	794	912	954	998	1126	1163
90"	428	413	424	436	448	503	521	532	552	597	628	650	667	735	777	821	935	980	1027	1162	1204
96"	433	418	427	441	452	513	528	548	563	615	646	664	692	751	797	843	965	1006	1060	1194	1235
102"	439	424	440	449	464	521	539	556	574	627	662	681	707	770	821	866	991	1037	1088	1227	1278
108"	446	431	445	459	473	528	552	567	588	643	674	699	726	789	843	890	1020	1065	1120	1262	1314
114"	455	440	449	469	481	539	559	582	604	654	695	718	744	809	861	914	1041	1091	1156	1310	1374
120"	456	441	459	476	493	552	567	595	615	667	707	729	758	829	888	936	1071	1127	1180	1326	1380
126"	463	448	469	489	500	559	584	606	624	678	722	751	779	846	906	961	1097	1154	1208	1355	1407

Features

- Choose .006 or .008 gauge 1" aluminum slat
- An illustration can be inverted or reversed or resized
- Angles must be greater than 30 degrees; headrail is split on many of these shapes
- Use 1" x 1½" steel headrail
- Valance not available
- Limitations may apply within each blind type. Fax a drawing to Customer Service to determine availability
- May require up to 2-4 weeks lead time to manufacture
- To order, fax a signed drawing with all dimensions to customer service.
- Available as Incline Wire for Skylights (see page 11)
- Available in all Classics colors (see page 26)

Controls

Controls: Standard, Reverse or Same Side (straight side only)
 Full Tilt Left or Right: Lift depends on shape
 Limited Tilt: Available
 Cord Tilt: Not available
 Top Lock Cord Lock: Not available

Size Considerations

	Octagon	Triangle	Other Shapes
Minimum Width	7½" Exact Head Rail	12"	7½" Exact Head Rail
Maximum Width	142" or 192" maximum total combined headrail segments		
Minimum Height	12"	6"	6"
Maximum Height	126"	126"	126"

Octagons, triangles and other shapes

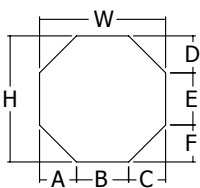

Octagon
Option U

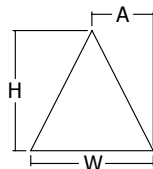

Triangle
Option T

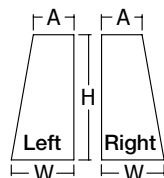

Inverted Side Cut
Option I

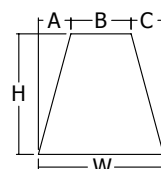

Inverted Double
Side Cut
Option I

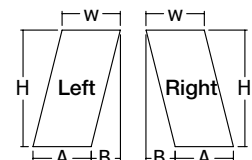

Offset Cut
Option I

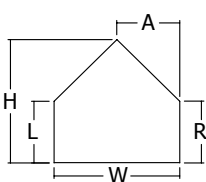

Extended Triangle
Option T

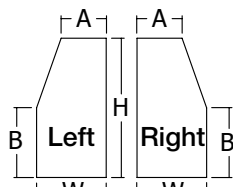

Extended
Inverted Side Cut
Option I

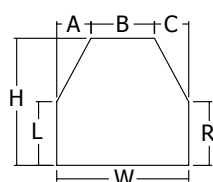

Extended Inverted
Double Side Cut
Option I

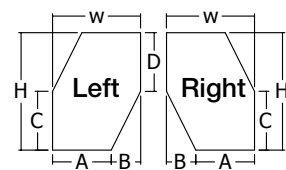

Extended
Offset Cut
Option I

1" Slats .006 Gauge

HEIGHT UP TO ↓	WIDTH UP TO →																				
	12"	23"	26"	29"	32"	36"	40"	44"	48"	52"	57"	62"	67"	72"	82"	92"	102"	112"	122"	132"	142"
42"	\$457	442	445	450	460	516	525	537	544	600	615	623	636	719	743	763	893	912	935	1059	1073
48"	460	445	450	461	467	528	537	547	553	614	631	642	654	737	763	788	914	935	964	1087	1109
54"	465	450	461	467	471	537	547	553	564	622	646	659	668	757	781	810	937	964	991	1116	1143
60"	476	461	467	471	486	547	553	565	574	636	659	671	686	770	801	826	964	991	1019	1146	1172
66"	479	464	471	486	495	553	565	574	588	652	671	686	698	791	819	846	988	1015	1049	1179	1210
72"	483	468	479	492	499	564	574	588	603	663	686	700	717	810	838	872	1011	1044	1080	1210	1239
78"	491	476	488	497	504	572	583	599	614	674	698	717	735	824	864	893	1036	1068	1108	1239	1273
84"	501	486	495	504	515	582	596	611	622	690	717	734	750	838	881	913	1060	1099	1138	1270	1305
90"	507	492	501	512	523	592	610	619	636	698	726	746	762	861	898	937	1080	1122	1164	1303	1341
96"	512	497	504	516	527	603	616	632	647	714	742	759	783	874	916	958	1108	1144	1194	1333	1370
102"	516	501	515	524	539	610	624	642	658	725	757	774	798	893	937	979	1131	1174	1220	1363	1409
108"	523	508	520	532	547	616	636	651	670	738	767	791	815	909	958	1002	1158	1199	1250	1393	1441
114"	530	515	524	543	555	624	644	664	685	750	786	807	832	926	975	1023	1178	1223	1281	1437	1496
120"	531	516	532	549	564	636	651	675	695	762	798	818	845	946	1000	1043	1204	1255	1305	1452	1501
126"	538	523	543	560	570	644	667	686	703	771	811	837	864	961	1016	1065	1227	1279	1329	1478	1527

1" Slats .008 Gauge

HEIGHT UP TO ↓	WIDTH UP TO →																				
	12"	23"	26"	29"	32"	36"	40"	44"	48"	52"	57"	62"	67"	72"	82"	92"	102"	112"	122"	132"	142"
42"	\$464	449	452	459	469	525	537	549	556	614	630	639	654	737	763	785	917	939	964	1090	1107
48"	467	452	459	471	476	540	549	559	567	628	648	659	671	757	785	813	941	964	996	1122	1146
54"	474	459	471	476	480	549	559	567	579	636	663	678	690	778	805	836	968	996	1025	1154	1183
60"	486	471	476	480	497	559	567	580	589	654	678	692	708	794	826	855	996	1025	1056	1187	1215
66"	488	473	480	497	507	567	580	589	604	670	692	708	721	815	847	876	1023	1052	1090	1223	1256
72"	492	477	490	504	511	579	589	604	620	682	708	723	742	836	869	905	1048	1084	1124	1256	1289
78"	503	488	500	509	517	588	600	616	632	695	721	742	762	851	895	926	1076	1111	1155	1289	1326
84"	512	497	507	517	529	599	614	630	643	711	742	761	777	869	916	950	1101	1143	1187	1323	1361
90"	519	504	515	525	539	610	628	640	659	721	753	773	791	893	933	977	1124	1170	1216	1359	1401
96"	524	509	517	531	543	620	635	655	670	738	769	788	815	908	953	1000	1155	1195	1250	1392	1433
102"	530	515	529	540	555	628	646	663	681	751	785	805	830	926	977	1023	1180	1227	1278	1425	1476
108"	536	521	536	549	564	635	659	674	695	766	798	822	850	946	1000	1048	1210	1255	1310	1460	1512
114"	544	529	540	560	572	646	666	690	711	777	818	842	868	965	1017	1071	1231	1281	1345	1508	1572
120"	546	531	549	567	583	659	674	702	722	791	830	853	881	985	1044	1092	1260	1317	1370	1524	1577
126"	554	539	560	579	591	666	692	712	731	802	846	874	904	1002	1063	1118	1286	1342	1397	1552	1604

Cut-Out Blinds

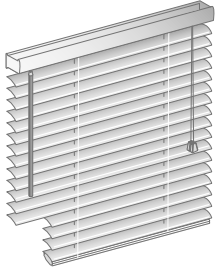

Bottom Corner:

1" and ½" Aluminum: Maximum cut-out is blind width minus 10". A cut-out over 10" requires an intermediate rail.
2" Vinyl and Aluminum: Maximum cut-out is 1" before the rout hole. NOT AVAILABLE WITH CORDLESS.
"A" minimum is 4½".

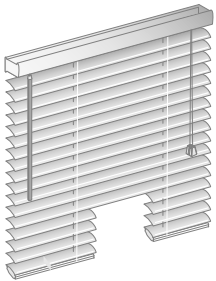
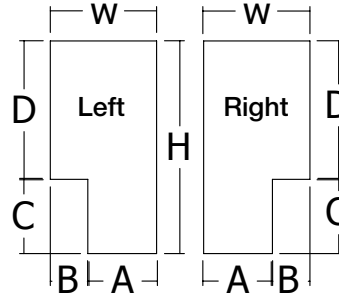

Bottom Center:

NOT AVAILABLE ON 2" BLINDS AND CORDLESS.
"A" and "C" minimum is 5".
If "B" is greater than 17", there will be an intermediate rail.

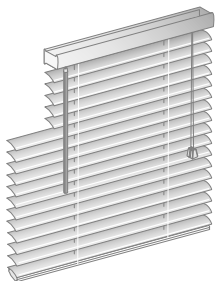
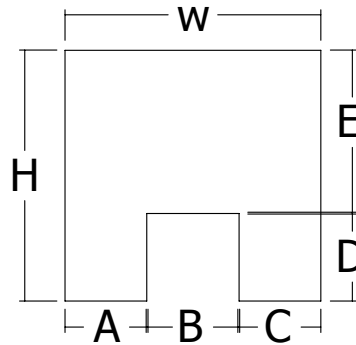

Top Corner:

Maximum cut-out is width is limited to ¼ of total blind width. NOT AVAILABLE ON 2" BLINDS AND CORDLESS.
"A" minimum is 14".
If "B" is greater than 8" there will be an intermediate rail.

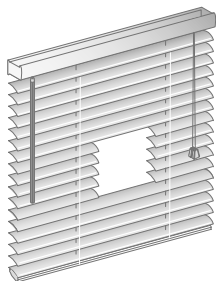
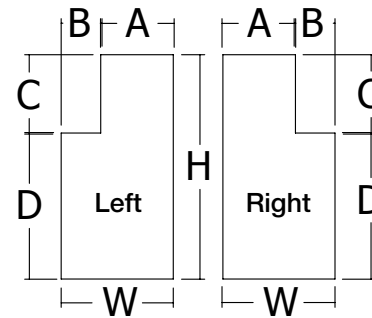

Interior:

"A" and "C" minimum width is 7½". Maximum width for B is blind width minus 15". Intermediate rail is required if B is greater than 17". NOT AVAILABLE ON 2" BLINDS AND CORDLESS.

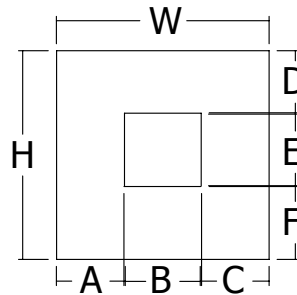

Note: Oversized cut-out could require an intermediate support rail. Slats will not lift below intermediate rail.

Surcharge: \$64

Making a Template for Specialty Shapes

1. Tape butcher paper, Kraft or construction paper over the window opening allowing plenty of overlap.
2. Being careful not to press against the template paper while tracing, draw an exact outline of the window opening. Pressing on the template paper may distort the paper and cause the wrong size to be made.
3. Remove the paper from the window opening. If the shade is an outside mount, add the desired amount of overlap to the window outline and draw a second outline around it to match the shape of the finished shade. **Be sure to erase the inside line.**
4. Mark the dimensions on the template. Check that the template dimensions match your measurements of the actual window opening.

NOTE: Make sure the template is of the window opening, not the glass only measurement.

5. **Cut the shape from the paper.**
6. **PLACE THE TEMPLATE BACK INTO THE WINDOW OPENING TO CHECK FOR PROPER FIT COMPLETELY AROUND.**
7. **Indicate on the template**
 - "room side" and "top" on the template
 - purchase order number
 - customer's name
 - your store name and account number
8. Attach a copy of your purchase order to the template.
9. Roll up template and place in a mailing tube.
DO NOT FOLD TEMPLATE.

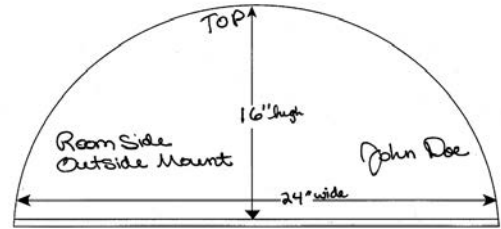

NOTE: This is just a sample for illustration purposes only-- other information may be needed for your order.

Mail to: Springs Window Fashions LLC
8467 Rt. 405 Hwy, South
PO Box 500
Montgomery PA 17752-0500
ATTN: Specialty Dept.

NOTE: When mailing, make sure to get a tracking number and note your return address on the mailing tube.

ACCEPTABLE MATERIALS FOR MAKING TEMPLATES:

Kraft Paper Butcher Paper
Construction Paper

WE WILL NOT ACCEPT TEMPLATES MADE FROM THE FOLLOWING MATERIALS:

Newspaper Plastic
Wax Paper Fabric
Tissue Paper Roofing Paper
Existing Arch Shades Wrapping Paper

NOTE: If the material used to make a template stretches, tears easily, will not lay flat or will mark the fabric – IT WILL NOT BE USED.

Using the Template Service

FEE: \$25 NET

To use the template service, simply:

1. Select Template Service when entering your order online.
2. **Use the template worksheet to determine what measurements you need to supply for each shape.**
3. Enter the lettered measurements using line item comments. The comments have been pre-programmed to all of the measurements you need to enter for your special shape.

See note at bottom of price grids if Template Service Fees apply.

Standard Colors

Color No.	Color Name	S3000	Classics	CustoMiser	S4000	Standard Micro	Color No.	Color Name	S3000	Classics	CustoMiser	S4000	Standard Micro
005	White Gloss	X	X	X	X	X	670	Creamy Beige	X	X	X	X	X
006	Raw Umber	X	X	X	X	X	680	Skyline	X	X			
011	Beige	X	X	X	X	X	724	Almond	X	X			
026	Smokey Gray	X	X	X	X	X	771	Mercury	X	X			
031	Fawn	X	X	X	X	X	778	Ice	X	X	X		
033	Pitch Black	X	X	X	X	X	904	Lamplight	X	X	X	X	X
042	Matte White	X	X	X	X	X	963	Stucco	X	X	X		
044	Granite	X	X	X			983	Gray Haze	X	X	X	X	X
057	Midnight Blue	X	X										
060	Milk Chocolate	X	X	X	X	X	Metallics						
062	Char Brown	X	X	X	X	X	034	Aluminum	X	X	X	X	X
065	Almost White Gloss	X	X	X	X	X	121	Brushed Aluminum	X	X	X	X	X
085	Real Red	X	X	X			126	Ash Metallic	X	X	X		
087	Forest Shadow	X	X	X			737	Silver	X	X	X		
089	True Blue	X	X	X			741	Polished Aluminum	X	X	X		
095	U.N. Gray	X	X	X									
100	Vanilla	X	X	X	X	X	Pearltones/Frost						
103	Tender Taupe	X	X				326	Alabaster Pearl	X	X	X	X	X
112	Alabaster	X	X	X	X	X	327	Fawn Pearl	X	X	X	X	X
122	Greige	X	X	X	X	X	328	Beige Pearl	X	X			
154	Hunter Green	X	X				637	White Pearl	X	X		X	X
168	Dark Bronze	X	X	X									
170	Silver Mist	X	X	X									
175	Weathered Taupe	X	X	X									
181	Natural Stone	X	X	X									
205	White Satin	X	X	X	X	X							
233	Black Satin	X	X	X	X	X							
375	Birch White	X	X										
376	Navajo White	X	X	X									
386	Snowcap White	X	X	X									
399	Rock Gray	X	X										
405	Gray Dawn	X	X										
535	Parchment	X	X	X	X	X							
541	Flax	X	X	X	X	X							
544	True White	X	X	X	X	X							
607	Cameo	X	X	X	X	X							
624	Buff	X	X	X									
625	Desert Sand	X	X	X									
629	Crystal White	X	X	X	X	X							
630	Coconut	X	X	X									
648	Magnet	X	X										
653	Burgundy	X	X	X									

The following colors are available in perforated slats for S3000, Classics and CustoMiser: 062P Char Brown, 112P Alabaster, 121P Brushed Aluminum, 205P White Satin and 233P Black Satin.

Aluminum Color Coordination Chart

Standard Colors

Color No.	Color Name	Headrail & Bottomrail	Braided Ladder Cord & Lift Tape	Tassel & End Caps	Color No.	Color Name	Headrail & Bottomrail	Braided Ladder Cord & Lift Tape	Tassel & End Caps
005	White Gloss	005	005	005	670	Creamy Beige	670	031	356
006	Raw Umber	006	033	006	680	Skyline	680	591	591
011	Beige	011	103	011	724	Almond	724	004	004
026	Smokey Gray	026	026	026	771	Mercury	771	026	026
031	Fawn	031	031	031	778	Ice	778	778	778
033	Pitch Black	033	033	033	904	Lamplight	904	031	031
042	Matte White	042	112	112	963	Stucco	963	026	963
044	Granite	044	814	825	983	Gray Haze	983	026	026
057	Midnight Blue	057	008	008					
060	Milk Chocolate	060	060	060					
062	Char Brown	062	062	062	Metallics				
065	Almost White Gloss	065	112	112	034	Aluminum	034	026	026
085	Real Red	085	835	025	121	Brushed Aluminum	034	026	026
087	Forest Shadow	087	087	087	126	Ash Metallic	126	126	126
089	True Blue	089	089	089	737	Silver	737	026	114
095	U.N. Gray	095	033	591	741	Polished Aluminum	034	026	026
100	Vanilla	100	112	100					
103	Tender Taupe	103	103	103					
112	Alabaster	112	112	112	Pearltones/Frost				
122	Greige	122	026	122	326	Alabaster Pearl	112	112	112
154	Hunter Green	154	154	117	327	Fawn Pearl	031	031	031
168	Dark Bronze	168	062	716	328	Beige Pearl	011	103	011
170	Silver Mist	170	193	170	637	White Pearl	205	005	005
175	Weathered Taupe	175	126	439					
181	Natural Stone	181	181	823					
205	White Satin	205	005	005					
233	Black Satin	233	033	033					
375	Birch White	375	005	005					
376	Navajo White	376	112	112					
386	Snowcap White	386	005	005					
399	Rock Gray	399	026	026					
405	Gray Dawn	405	026	026					
535	Parchment	535	004	004					
541	Flax	541	112	112					
544	True White Gloss	544	005	005					
607	Cameo	670	031	356					
624	Buff	624	031	031					
625	Desert Sand	625	029	029					
629	Crystal White	629	005	005					
630	Coconut	630	112	112					
648	Magnet	648	648	648					
653	Burgundy	653	106	106					

