

A close-up photograph of light-colored cellular shades with a pleated texture. The shades are partially open, revealing a window with a view of greenery outside. In the foreground, a vase with green leaves and small white flowers is visible on the right side.

GRABER®

Graber CrystalPleat® Cellular Shades
English US Price Guide

Product Information Guide

Features

Fabric Styles and Information: Cellular Shades3
 Light Control and Privacy3
 Summary4

Control Type and Size Considerations

Cord Lift5
 Bottom Up/Top Down Cord Lift5
 Sun Up/Sun Down Cord Lift6
 Perfect-Vue™ Cord Lift6
 Depth Requirements for Inside Mount: Cord Lift and Perfect-Vue Cord Lift6
 Cordless Lift7
 Bottom Up/Top Down Cordless Lift7
 Sun Up/Sun Down Cordless Lift7
 Perfect-Vue Cordless Lift8
 Depth Requirements for Inside Mount: Cordless Lift and Perfect-Vue Cordless Lift8
 Continuous-Loop Lift9
 Top Down Continuous-Loop Lift10
 Depth Requirements for Inside Mount: Continuous-Loop Lift10
 Motorized Lift11
 Multiple Shades on One Headrail12
 Multiple Shades on One Headrail: Continuous-Loop Lift12
 Perfect-Vue Cord Lift13
 Perfect-Vue Cordless Lift14
 Slide-Vue™ Shades15
 Depth Requirements for Inside Mount: Slide-Vue Shades15
 Enhanced Light Control Features16
 Corner Windows17
 Bay Windows18
 Cut-Out Shades19
 SkyTrack™ Skylight19
 Specialty Shapes: Arch Shades20
 Specialty Shapes: Arch Over Standard Cord Lift Shade20
 Specialty Shapes: Octagon and Hexagon21
 Specialty Shapes: Trapezoids21
 Specialty Shapes: Angle Top/Angle Bottom21

PLEASE NOTE:

Photos and illustrations are for inspiration only.
 Not all product configurations are available in all countries.
 Window blind cords are a strangulation hazard for young children.
 Consult your dealer or store associate for cordless products, or products with inaccessible cords. Remove this product immediately if a cord longer than 22 cm, or a loop exceeding 44 cm, becomes accessible.

Options

| | |
|---|----|
| Making a Template for Specialty Windows | 22 |
| Using a Template Service | 22 |

General Information

| | |
|---|-------|
| Energy Performance | 23 |
| Energy Efficiency Ratings | 23 |
| Stack Height Chart Cord Lift | 24 |
| Stack Height Chart: Perfect-Vue™ | 25 |
| Stack Width Chart Slide-Vue™ | 26 |
| Standard Handle Location for Slide-Vue | 26 |
| Cellular Shade Color Coordination Chart | 27-29 |
| Cord Lift Product Detail | 30 |
| Cordless Lift Product Detail | 31 |
| Continuous-Loop Lift Product Detail | 32 |
| Bottom Up/Top Down Cord Lift Product Detail | 33 |
| Bottom Up/Top Down Cordless Lift Product Detail | 34 |
| Cord Lift Product Detail Perfect-Vue | 35 |
| Cordless Lift Product Detail Perfect-Vue | 36 |
| Arch Over Standard Cord Lift Product Detail | 37 |
| Slide-Vue™ Product Detail | 38 |

Features

Grabber® CrystalPleat® Cellular Shades are made from a variety of luxurious spunlace and woven fabrics. These shades are highly insulating due to the pockets of air formed by the cellular design. Grabber CrystalPleat Cellular Shades are the perfect combination of function and fashion, providing energy efficiency while stylishly covering your windows.

- Highly insulating
- Solutions for numerous privacy and light control needs
- Offered in four cell sizes to match diverse decor styles
- Broad spectrum of on-trend colors, patterns, and textures to enhance every room
- All shade components are color coordinated

Fabric Styles and Information: Cellular Shades

| Fabric Styles | Cell Size | Level of Light Control/Privacy | Fabric Content |
|---------------|---|--------------------------------|---|
| Couture | ¾" Single Cell | Semi-sheer Blackout | 100% polyester woven paired with 100% polyester spunlace 100% polyester woven paired with a concealed blackout liner |
| Discovery | ¾" Single Cell ¾" Single Cell | Blackout | 100% polyester spunlace with metallic blackout liner |
| Enchantment | ¾" Single Cell | Light filtering Blackout | 100% polyester spunlace 100% polyester spunlace metallic blackout liner |
| Endeavor | ¾" Single Cell ¾" Single Cell | Light filtering | 100% polyester spunlace |
| Infuse | ¾" SC | Light Filtering Blackout | 100% polyester spunlace 100% polyester spunlace with metallic blackout liner |
| Kinsley | ¾" Single Cell | Semi-sheer Blackout | 100% polyester woven paired with 100% polyester spunlace 100% polyester woven paired with a concealed blackout liner |
| Montage | ¾" Single Cell | Light filtering Blackout | 100% polyester spunlace 100% polyester spunlace metallic blackout liner |
| Prestige | ¾" Single Cell | Light filtering Blackout | 100% polyester spunlace 100% polyester spunlace metallic blackout liner |
| Sanctuary | ½" Double Cell ¾" Single Cell 1¼" Single Cell | Blackout Blackout | 100% polyester spunlace with concealed blackout liner 100% polyester spunlace with white blackout liner |
| Scroll FR | ¾" Single Cell | Light filtering | 100% polyester spunlace |
| Simply Sheer | ¾" Single Cell | Sheer | 100% polyester woven |
| Splendor | ½" Double Cell ¾" Single Cell 1¼" Single Cell | Light filtering | 100% polyester spunlace |
| Valletta | ¾" Single Cell 1¼" Single Cell | Light filtering | 100% polyester woven |

Light Control and Privacy

Sheer: Allows the most sunlight and the least privacy.

Semi-Sheer*: Allows moderate sunlight and a little privacy.

Light Filtering (LF)*: Blocks some sunlight and offers some privacy.

Blackout (BO): Blocks all sunlight and offers complete privacy.

*These fabrics allow some light to come through, so their colors may be influenced by changing light conditions. Colors may appear to vary depending upon the time of day and type of lighting, as well as whether the shade is partially or fully lowered.

Features

Summary (for surcharges and pricing refer to price charts)

The following is a list of options for cellular shades.

Control Type Options (see price charts for pricing and/or surcharges)

- Cord lift (US only)
- Cordless lift
- Continuous-loop lift
- Motorized lift (see motorization product information guide)
- Slide-View™ (US only)

Shade Options—No Charge

- Cord placement on right or left
- Corner or bay window
- Hold down brackets
- Lightblocking strip available with cordless lift, continuous-loop lift, and motorized lift
- Projection brackets:
 - For all cord lift, cordless lift, continuous-loop lift, and motorized lift shades:
 - Long (adds up to 2³/₈" extension from wall)
 - Medium (adds up to 1¹/₂" extension from wall)
 - Short (adds up to ⁷/₈" extension from wall)
 - For Slide-View (US only):
 - Long (adds up to 2¹/₄" extension from wall)
 - Medium (adds up to 1¹/₄" extension from wall)
 - Short (adds up to ³/₄" extension from wall)
- Rail color can be specified at the time of order
- Shims
- Side-mount brackets: inside mount only
- Standard cord cleats (US only): clear
- Fabric can be reversed at the time of order
- Custom cord length is available upon request at time of order (US only)

Specialty Shape Shade Options (see price charts for pricing and/or surcharges)

- Angled top/angled bottom (US only)
- Arch over standard cord lift (US only)
- Non-Perfect Arches (US only)
- Octagon, hexagon, or trapezoid (US only)
- Perfect Arches

Shade Options—Surcharge (see price charts for pricing and/or surcharges)

- Room-darkening side channels (³/₄" single cell, and ¹/₂" double cell with cord lift and cordless lift controls)
- Bottom up/top down: cord lift (US only)
- Bottom up/top down: cordless lift (US only)
- Cord winder (US only)
- Cut-outs (US only)
- Decorative cord cleats: solid brass, antique brass (US only)
- Multiple shades on one headrail
- Perfect-View™ shade (US only): cord lift
- Perfect-View shade (US only): cordless lift
- Sky pole
- Skylight shades (US only)
- Sun up/sun down: cord lift (US only)
- Sun up/sun down: cordless lift
- Top down only (US only): continuous-loop lift
- Wood cornice (see cornices and valances product information guide)

Control Type

| Cell Size | Cord Lift | Cordless Lift | Continuous-Loop Lift | Motorized Lift | Slide-View | Bottom Up/Top Down | Top Down | Sun up/Sun Down | Perfect-View | Specialty Shapes | Skylights | Side Channels |
|---|-----------|---------------|----------------------|----------------|------------|--------------------|----------|-----------------|--------------|------------------|-----------|---------------|
| ³ / ₈ " Single Cell | • | • | • | • | | • | • | • | • | • | | |
| ³ / ₄ " Single Cell | • | • | • | • | • | • | • | • | • | • | • | • |
| ¹ / ₂ " Double Cell | • | • | • | • | • | • | • | • | • | • | • | • |
| 1 ¹ / ₄ " Single Cell | | • | | • | • | • | | | | | | |

Control Type and Size Considerations

Cord Lift

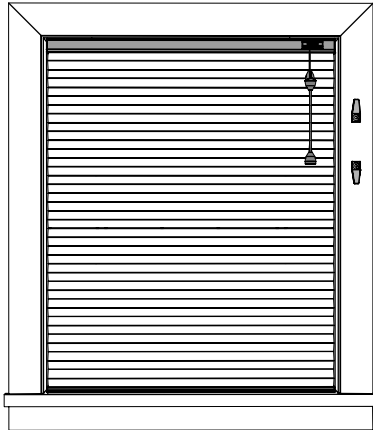

- **No charge**
- Controls can be placed on the right (standard) or left side; side mounts available up to 60" wide by 96" high
- Room-darkening side channels are available:
 - Surcharge (see price charts)
 - 3/4" single cell and 1/2" double cell only
 - Available in cord lift and cordless lift
 - Side channels are Canyon Gray 053, Cream 715, Creamy Pearl 356, Revere Pewter 190, Sable 565, Smokey Gray 026, or White Satin 205
- Cord management safety options keep the cord out of reach of children and pets to eliminate dangling cord hazards
- Cord length is 1/3 of the shade height
- Product will have one or more cord release devices based on compliance with ANSI/WCMA safety standards
- Cord lift not available in 1/4" single cell

| Size Considerations | Minimum Width* (inches) | Maximum Width** (inches) | Minimum Height (inches) | Maximum Height** (inches) |
|------------------------------|-------------------------|--------------------------|-------------------------|---------------------------|
| Cord Lift | 9 | 144 | 12 | 144 |
| Bottom Up/Top Down Cord Lift | 9 | 96 | 12 | 96 |
| Sun Up/Sun Down Cord Lift | 12 | 74 | 12 | 96 |
| Perfect-View™ Cord Lift† | 12 | 78 | 12 | 96 |

*For all inside mount applications, 3/8" deduction is taken by manufacturer on overall width.

**See cord control area limit chart for SIZE RESTRICTIONS by fabric type.

†Minimums and maximums vary slightly by cell size. Maximum shade width is based on fabric width. See Perfect-View size considerations for detail.

| Cord Control Area Limit Chart | | |
|-------------------------------|-------------------|------------------------------------|
| Cell Size | Collection Name | Maximum Shade Size (square inches) |
| 1/2" Double Cell | Sanctuary | 7,400 |
| 1/2" Double Cell | Splendor | 9,000 |
| 3/4" Single Cell | Discovery | 12,000 |
| | Kinsley LF and BO | |
| | Sanctuary | |
| | Couture BO | |
| | Enchantment BO | |
| | Infuse BO | |
| 3/4" Single Cell | Montage BO | 14,000 |
| | Prestige BO | |
| | Couture LF | |
| | Enchantment LF | |
| | Endeavor | |
| | Infuse LF | |
| | Montage LF | |
| | Prestige LF | |
| 3/8" Single Cell | Scroll FR | 14,000 |
| | Simply Sheer | |
| | Splendor | |
| 3/8" Single Cell | Valletta | 14,000 |
| | Discovery | |
| 3/8" Single Cell | Endeavor | 14,000 |

Control Type and Size Considerations

Bottom Up/Top Down Cord Lift

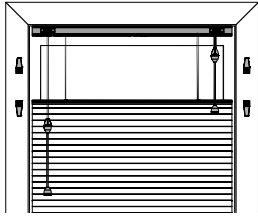

- Standard control is right control operates bottom up, while left control operates shade from the top down; this can be reversed
- Option allows for privacy, yet lets natural light shine in
- Product will have one or more cord release devices based on compliance with ANSI/WCMA safety standards

Sun Up/Sun Down Cord Lift



- Perfect for combining light controls of sheer, semi-sheer, or light-filtering and blackout fabrics
- $\frac{3}{8}$ " single cell fabrics can only be combined with $\frac{3}{8}$ " single cell fabrics
- $\frac{3}{4}$ " single cell fabrics can only be combined with $\frac{1}{2}$ " double cell or $\frac{3}{4}$ " single cell fabrics
- $\frac{1}{2}$ " double cell can only be a bottom fabric; two $\frac{1}{2}$ " double cell fabrics cannot be combined
- Headrail, midrail, and bottomrail are color coordinated; headrail and midrail match top fabric and bottomrail matches bottom fabric
- Standard control is right control operates bottomrail, while left control operates intermediate rail (can be reversed)
- Product will have one or more cord release devices based on compliance with ANSI/WCMA safety standards

Perfect-Vue™ Cord Lift



- Perfect for combining light controls of sheer and light-filtering pleated fabric with blackout cellular fabrics
- Standard control is right control operates bottomrail, while left control operates intermediate rail (can be reversed)
- 1" pleated can be combined with $\frac{3}{8}$ " single cell cellular fabrics only
- 2" pleated can be combined with $\frac{3}{4}$ " single cell and $\frac{1}{2}$ " double cell cellular fabric only
- Headrail, midrail, and bottomrail are color coordinated; headrail and midrail match top fabric and bottomrail matches bottom fabric
- Not available with cut-outs, overlaps, or liners
- Product will have one or more cord release devices based on compliance with ANSI/WCMA safety standards

Depth Requirements for Inside Mount: Cord Lift and Perfect-Vue Cord Lift

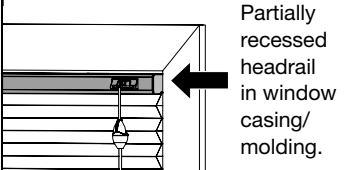
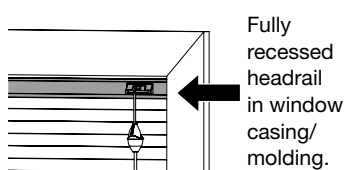
| Shade Type | Cell Size (inches) | Cord Lift Headrail Dimensions (inches) |  Partially recessed headrail in window casing/molding. | |  Fully recessed headrail in window casing/molding. | |
|-----------------------|--|--|---|----------------------------|--|--|
| | | | Minimum Depth Mount (inches) | Flush with Casing (inches) | | |
| Cord Lift | $\frac{3}{4}$ " Single Cell $\frac{1}{2}$ " Double Cell | $\frac{7}{8}$ x $2\frac{1}{16}$ | $1\frac{1}{16}$ | $2\frac{1}{4}$ | | |
| | $\frac{3}{8}$ " Single Cell | $\frac{7}{8}$ x $1\frac{1}{4}$ | $1\frac{1}{16}$ | $1\frac{1}{16}$ | | |
| Perfect-Vue Cord Lift | 1" Pleat | $\frac{7}{8}$ x $1\frac{1}{4}$ | $1\frac{1}{16}$ | $1\frac{1}{16}$ | | |
| | 2" Pleat | $\frac{7}{8}$ x $2\frac{1}{16}$ | $1\frac{1}{16}$ | $2\frac{1}{4}$ | | |

Control Type and Size Considerations

Cordless Lift

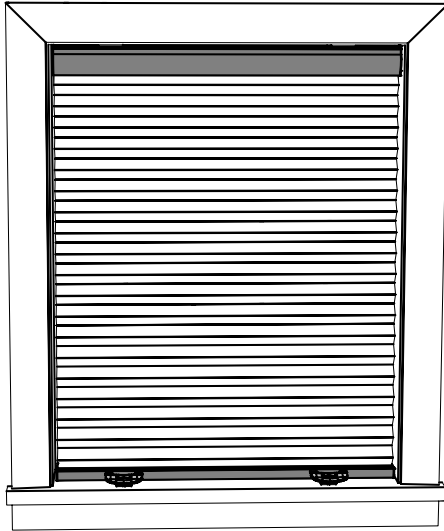

- Applies to standard, bottom up/top down, sun up/sun down, and Perfect-Vue™ shades
- Safest window shade; ideal for homes with children or pets
- Side mounts available up to 60" wide
- An optional sky pole is available for hard to reach shades 24" or less in width; if a skypole is required for shades over 24" in width, two skypoles are recommended to ensure even operation
- Room-darkening side channels are available:
 - Surcharge (see price charts)
 - ¾" single cell and ½" double cell only
 - Available in cord lift and cordless lift
 - Side channels are Canyon Gray 053, Cream 715, Creamy Pearl 356, Revere Pewter 190, Sable 565, Smokey Gray 026, or White Satin 205

NOTE: All cordless lift shades should be used on windows where the consumer can comfortably raise and lower the shade with their hand and have easy access. Very high windows should use cord lift shades rather than cordless lift .

| Size Considerations | Minimum Width* (inches) | Maximum Width (inches) | Minimum Height (inches) | Maximum Height (inches) |
|----------------------------------|-------------------------|------------------------|-------------------------|-------------------------|
| Cordless Lift | 9 | 120 | 9 | 86 |
| Bottom Up/Top Down Cordless Lift | 15 | 120 | 9 | 86 |
| Sun Up/Sun Down Cordless Lift | 15 | 96 | 12 | 86 |
| Perfect-Vue Cordless Lift† | 15 | 94 | 12 | 86 |

*For all inside mount applications, ¾" deduction is taken by manufacturer on overall width.

†Minimums and maximums vary slightly by cell size. Maximum shade width is based on fabric width. See Perfect-Vue size considerations for details.

NOTE: Maximum area for Sanctuary ½" double cell is 9,216 square inches, 6,400 square inches with Perfect-Vue.

Bottom Up/Top Down Cordless Lift

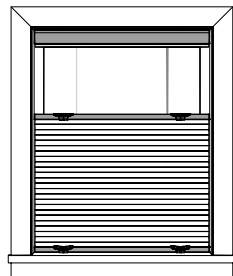

- Option allows for privacy, yet lets natural light shine in

| Cell Size | Collection Name | Minimum Width* (inches) | Maximum Width (inches) | Minimum Height (inches) | Maximum Height (inches) |
|-----------------|---|-------------------------|------------------------|-------------------------|-------------------------|
| ½" Double Cell | Sanctuary | 15 | 96 | 9 | 86 |
| ½" Double Cell | Splendor | 15 | 108 | 9 | 86 |
| ¾" Single Cell | Couture LF and BO, Enchantment BO, Infuse BO, Kinsley LF and BO, Montage BO, Prestige BO, Sanctuary BO, Scroll FR | 15 | 108 | 9 | 86 |
| ¾" Single Cell | Discovery, Enchantment LF, Endeavor, Infuse LF, Montage LF, Prestige LF, Simply Sheer, Splendor LF, Valletta | 15 | 120 | 9 | 86 |
| ¾" Single Cell | Discovery | 15 | 108 | 9 | 86 |
| ¾" Single Cell | Endeavor | 15 | 120 | 9 | 86 |
| 1¼" Single Cell | Splendor | 15 | 120 | 9 | 86 |
| 1¼" Single Cell | Sanctuary, Valletta | 15 | 108 | 9 | 86 |

Control Type and Size Considerations

Sun Up/Sun Down Cordless Lift

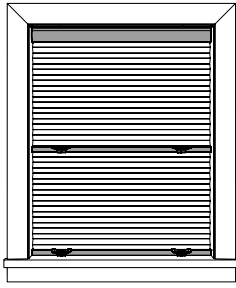

- Perfect for combining light controls of sheer, semi-sheer, or light-filtering and blackout
- $\frac{3}{8}$ " single cell fabrics can only be combined with $\frac{3}{8}$ " single cell fabrics
- $\frac{3}{4}$ " single cell fabrics can only be combined with $\frac{1}{2}$ " double cell or $\frac{3}{4}$ " single cell fabrics
- $\frac{1}{2}$ " double cell can only be a bottom fabric; two $\frac{1}{2}$ " double cell fabrics cannot be combined
- Headrail, midrail, and bottomrail are color coordinated; headrail and midrail match top fabric and bottomrail matches bottom fabric
- $\frac{1}{4}$ " single cell is not available in sun up/sun down

Perfect-Vue™ Cordless Lift

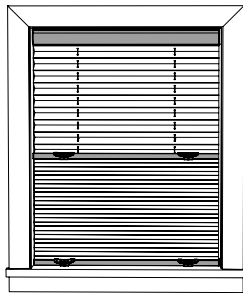

- Perfect for combining light controls of sheer and light-filtering pleated fabric with blackout cellular fabrics
- 1" pleated can be combined with $\frac{3}{8}$ " single cell cellular fabrics only
- 2" pleated can be combined with $\frac{3}{4}$ " single cell and $\frac{1}{2}$ " double cell cellular fabric only
- Headrail, midrail, and bottomrail are color coordinated; headrail and midrail match top fabric and bottomrail matches bottom fabric
- $\frac{1}{4}$ " single cell is not available in Perfect-Vue shades

Depth Requirements for Inside Mount: Cordless Lift and Perfect-Vue Cordless Lift

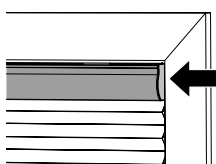
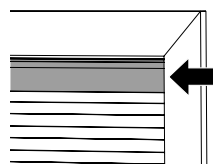
| Shade Type | Cell Size | Cordless Lift Headrail Dimensions (inches) |  Partially recessed headrail in window casing/molding. |  Fully recessed headrail in window casing/molding. |
|---------------------------|--|--|--|--|
| | | | Minimum Depth Mount (inches) | Flush with Casing (inches) |
| Cordless Lift* | $\frac{1}{4}$ " Single Cell | $1\frac{1}{8} \times 3\frac{3}{16}$ | $1\frac{1}{8}$ | $3\frac{3}{8}$ |
| | $\frac{1}{2}$ " Double Cell $\frac{3}{4}$ " Single Cell | $1\frac{1}{16} \times 2\frac{3}{8}$ | $\frac{5}{8}$ | $2\frac{3}{8}$ |
| | $\frac{3}{8}$ " Single Cell | $1\frac{1}{16} \times 2\frac{1}{8}$ | $\frac{5}{8}$ | $2\frac{3}{8}$ |
| Perfect-Vue Cordless Lift | 1" Pleat | $1\frac{1}{16} \times 2\frac{1}{8}$ | $\frac{5}{8}$ | $2\frac{3}{8}$ |
| | 2" Pleat | $1\frac{1}{16} \times 2\frac{3}{8}$ | $\frac{5}{8}$ | $2\frac{3}{8}$ |

*The depth requirements for cordless lift shades also apply to motorized and continuous-loop lift shades.

Control Type and Size Considerations

Continuous-Loop Lift

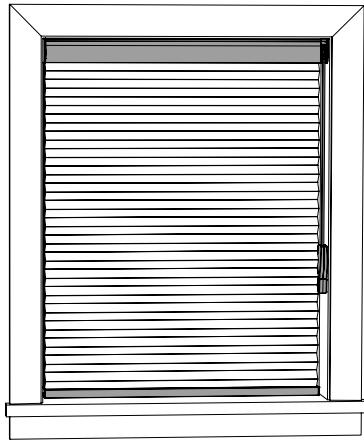

- Canada only - Shroud is required for all Canadian orders



- For surcharges, see price charts
- Recommended for larger, heavier shades
- A single continuous-loop cord raises and lowers the shade and keeps the cord the same length
- 1¼" single cell fabrics not available with continuous-loop lift
- Four colors of continuous-loop cord available (US only. Canadian orders will come with a clear shroud and white cord)
- Continuous-loop lift stacks the fully raised shade more compactly than cord lift and holds it more securely
- A cord hold down device is included with all continuous loop lift systems; the device must be properly installed to safely control the cord loop
- For inside mount, install the shade in the back of the window frame so the cord tensioner can be mounted in front of the shade and not interfere with shade operation
- Larger shades use a larger clutch ratio for easier lifting, but additional pulls are required to raise the shade

| Size Considerations | Minimum Width* (inches) | Maximum Width*** (inches) | Minimum Height (inches) | Maximum Height*** (inches) |
|------------------------------------|-------------------------|---------------------------|-------------------------|----------------------------|
| Continuous-Loop Lift | 18½ | 144 | 9 | 144 |
| Top Down Only Continuous-Loop Lift | 18½ | 72 | 12 | 96 |

*For all inside mount applications, ⅜" deduction is taken by manufacturer on overall width.

**See continuous-loop lift control area limit chart for SIZE RESTRICTIONS by fabric type.

† Maximum shade size of 144" x 144" achievable by ordering multiple shades on one headrail.

| Finished Shade Height (inches) | Continuous-Loop Cord Length (inches) |
|--------------------------------|--------------------------------------|
| 12 to 26 | 18 |
| 26⅙ to 38 | 24 |
| 38⅙ to 50 | 36 |
| 50⅙ to 62 | 48 |
| 62⅙ to 74 | 60 |
| 74⅙ to 96 | 72 |
| 96⅙ to 120 | 84 |
| 120⅙ to 130 | 96 |
| 130⅙ to 144 | 108 |

Control length for continuous-loop lift shades varies based on finished shade height (above). Optional cord loop length can be specified at the time of order.

| Continuous-Loop Lift Area Limit Chart | | |
|---------------------------------------|-----------------|------------------------------------|
| Cell Size | Collection Name | Maximum Shade Size (square inches) |
| ½" Double Cell | Sanctuary | 9,000 |
| | Couture BO | |
| | Enchantment BO | |
| ¾" Single Cell | Infuse BO | 11,000 |
| | Kinsley LF | |
| | Kinsley BO | |
| | Montage BO | |
| | Prestige BO | |
| ¾" Single Cell | Sanctuary | 13,000 |
| | Scroll FR | |
| | Infuse LF | |
| ½" Double Cell | Splendor | 13,000 |
| | Enchantment LF | |
| ¾" Single Cell | Montage LF | 17,000 |
| | Prestige LF | |
| | Splendor LF | |
| | Discovery | |
| ⅝" Single Cell | Endeavor | 17,000 |
| | Couture LF | |
| | Discovery | |
| ¾" Single Cell | Endeavor | 20,800* |
| | Simply Sheer | |
| | Valletta | |
| | | |

*Available up to 144" width x 144" height.

| Loop Cord and Tensioner Device Colors: | |
|--|-----|
| Smokey Gray | 026 |
| Tender Taupe | 103 |
| Vanilla | 100 |
| White | 00 |

Control Type and Size Considerations

Top Down Continuous-Loop Lift

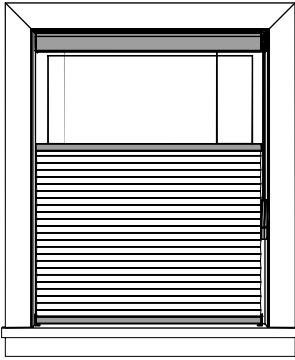

- Top down only operates with the continuous-loop lift
- Bottomrail must be mounted

NOTE: Top down only shades that exceed the maximum width may be made as multiple shades on one headrail. However, an additional surcharge will be added if the total ordered width is less than or equal to the maximum fabric width.

Depth Requirements for Inside Mount: Continuous-Loop Lift

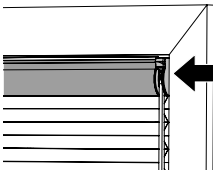
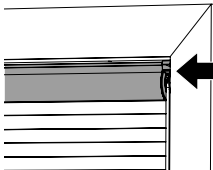
| Shade Type | Cell Size | Continuous-Loop Lift Headrail Dimensions (inches) |  Partially recessed headrail in window casing/molding. |  Fully recessed headrail in window casing/molding. |
|----------------------|--|---|--|--|
| | | | Minimum Depth Mount (inches) | Flush with Casing (inches) |
| Continuous-Loop Lift | $\frac{3}{4}$ " Single Cell $\frac{1}{2}$ " Double Cell | $1\frac{1}{16} \times 2\frac{3}{8}$ | $\frac{5}{8}$ | $2\frac{3}{8}$ |
| | $\frac{3}{8}$ " Single Cell | $1\frac{1}{16} \times 2\frac{1}{8}$ | $\frac{5}{8}$ | $2\frac{3}{8}$ |

Control Type and Size Considerations

Motorized Lift

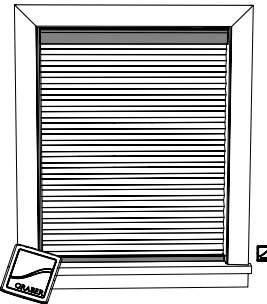

- **Refer to motorization product information guide for additional options, sizing, and pricing**
- Window treatments can be operated from virtually anywhere in the home
- Provides easy operation of hard-to-reach or large window coverings
- Efficiently manages energy (heat gain and loss)
- Operate multiple window treatments simultaneously or individually
- A safer alternative to accessible cords that are traditionally used to operate window coverings; ideal for homes with children and pets
- Easily integrated with home automation systems
- Low voltage motorization requires no costly electrical hardwiring
- Multiple control and power options available, see motorization product information guide for options
- Boost room-darkening performance by reducing light leakage between the window and headrail by adding a lightblocking strip at no additional surcharge

NOTE: Motorization components and accessories have a five-year limited warranty, excluding batteries.

Control Type and Size Considerations

Multiple Shades on One Headrail

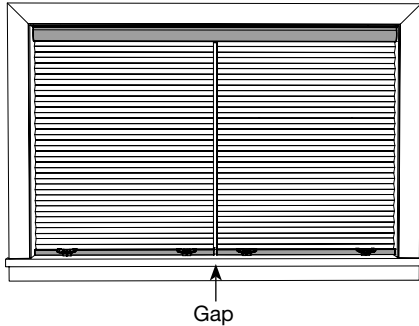

- Cord lift available as two-on-one headrail
- Cordless lift and continuous-loop lift available as two or three shades on one headrail
- Side mount brackets available on shades 60" or smaller
- Shade widths exceeding 144" wide made as two shades on one headrail: no charge

| Size Considerations | Maximum Overall Size For Multiple Shades* (inches) | Maximum Size with Side Mount (inches) | Control Locations | Gap (inches) |
|---------------------|--|---------------------------------------|--|--------------|
| Cordless Lift | 144 x 86 | 60 x 86 | Not applicable | 3/8 |
| Cord Lift | 192 x 144 | 60 x 96 | Two-on-one: Left shade, left control Right shade, right control | 1/2 |

*See size considerations section for the minimum and maximum panel widths.

Multiple Shades on One Headrail: Continuous-Loop Lift

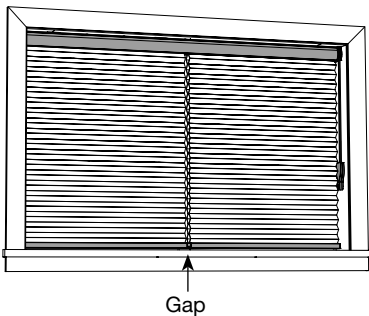

- Available as two or three shades on one headrail
- Side mount brackets available on shades 60" or smaller
- With multiple shades on one headrail, area limits are based on the sum of all shade panels on a control
- See continuous-loop area limit chart for maximum area limits

| Size Considerations | Maximum Overall Size For Multiple Shades* (inches) | Maximum Size with Side Mount (inches) | Control Locations | Gap (inches) |
|--|--|---------------------------------------|---|--------------|
| Continuous-Loop Lift Single Control Shade | 120 x 144 | 60 x 96 | Two-on-one: Common lift cord can be on right or left to operate both shades at the same time Three-on-one: Common lift cord can be on right or left to operate all shades at the same time | 1/2 |
| Continuous-Loop Lift Multi Control Shade | 144 x 144 | 60 x 96 | Two-on-one: Left shade, left control Right shade, right control Three-on-one: Left shade, left control Right shade, right control Middle shade, common lift cord to right or left blind Continuous-loop lift cannot be used in the middle of the headrail on multiple shades | 1/2 |
| Continuous-Loop Lift Top Down Only- Single Control Shade | 120 x 96 | NA | Two-on-one: Common lift cord can be on right or left to operate both shades at the same time Three-on-one: Common lift cord can be on right or left to operate all shades at the same time | 1/2 |
| Continuous-Loop Lift Top Down Only- Multi Control Shade | 144 x 96 | NA | Two-on-one: Left shade, left control Right shade, right control Three-on-one: Left shade, left control Right shade, right control Middle shade, common lift cord to right or left blind Continuous-loop lift cannot be used in the middle of the headrail on multiple shades | 1/2 |

*See size considerations section for the minimum and maximum panel widths.

Control Type and Size Considerations

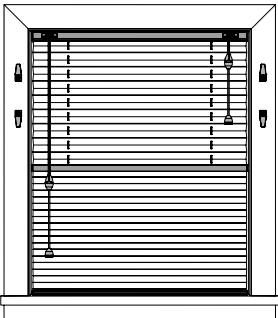
| Perfect-Vue™ Cord Lift | | | | |
|-------------------------------|--|-----------------------------|-----------------------------|-----------------------------|
| |  | | | |
| | Cord Lift All Cellular Fabric Styles | | | |
| | Width | | Height | |
| Fabric Styles | Minimum† (inches) | Maximum (inches) | Minimum (inches) | Maximum (inches) |
| 1" FashionPleat® | | | | |
| Allure | 12 | 72 | 12 | 96 |
| Desert | 12 | 72 | 12 | 96 |
| Eloquence | | | | |
| Geneva | | | | |
| Sheer Linen | 12 | 72 | 12 | 96 |
| Tuvalu | | | | |
| 1" EvenPleat® | | | | |
| Allure | | | | |
| Geneva | | | | |
| Grasscloth | 12 | 72 | 12 | 96 |
| Sheer Linen | | | | |
| Tuvalu | | | | |
| Marquis | 12 | 76 | 12 | 96 |
| Imperial | | | | |
| Muse | | | | |
| Prism | 12 | 78 | 12 | 96 |
| Serendipity | | | | |
| Debonair | | | | |
| Desert | 12 | 78 | 12 | 96 |
| Eloquence | | | | |
| 2" EvenPleat | | | | |
| Crossweave | | | | |
| Geneva | | | | |
| Grasscloth | 18 | 72 | 12 | 96 |
| Sheer Linen | | | | |
| Marquis | 18 | 76 | 12 | 96 |
| Prism | 18 | 78 | 12 | 96 |
| Serendipity | | | | |
| Debonair | | | | |
| Desert | 18 | 78 | 12 | 96 |

†For all inside mount applications, 3/8" deduction is taken by manufacturer on overall width.

Maximum area for Sanctuary 1/2" DC is 6,400 square inches.

Maximum area for 1" Debonair is 6,400 square inches , 2" Debonair is 5,800 square inches.

Control Type and Size Considerations

Perfect-Vue™ Cordless Lift

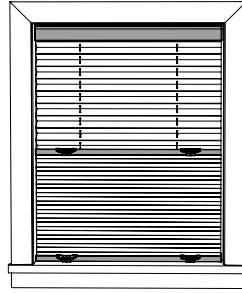

**Cordless Lift
All Cellular Fabric Styles**

| Fabric Styles | Width | | Height | |
|---|----------------------|---------------------|---------------------|---------------------|
| | Minimum† (inches) | Maximum (inches) | Minimum (inches) | Maximum (inches) |
| 1" FashionPleat® | | | | |
| Allure Sheer Linen Tuvalu | 15 | 72 | 12 | 86 |
| Desert Eloquence | 15 | 94 | 12 | 86 |
| 1" EvenPleat® | | | | |
| Allure Grasscloth Sheer Linen Tuvalu | 15 | 72 | 12 | 86 |
| Marquis Imperial | 15 | 76 | 12 | 86 |
| Muse Prism Serendipity | 15 | 92 | 12 | 86 |
| Debonair Desert Eloquence | 15 | 94 | 12 | 86 |
| 2" EvenPleat | | | | |
| Crossweave Grasscloth Sheer Linen | 15 | 72 | 12 | 86 |
| Marquis Prism Serendipity | 15 | 76 | 12 | 86 |
| Debonair Desert | 15 | 92 | 12 | 86 |

†For all inside mount applications, 3/8" deduction is taken by manufacturer on overall width.

Maximum area for Sanctuary 1/2" double cell is 6,400 square inches.

Maximum area for 1" Debonair is 6,400 square inches, 2" Debonair is 5,800 square inches.

Control Type and Size Considerations

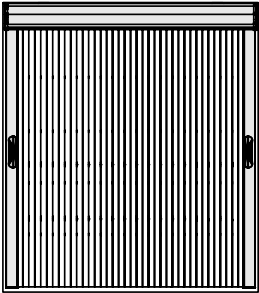
| Slide-View™ Shades | | | | |
|----------------------|--|-----------------------------|-----------------------------|-----------------------------|
| |  | | | |
| | Slide-View All Fabric Styles | | | |
| | Width | | Height | |
| Fabric Styles | Minimum (inches) | Maximum (inches) | Minimum (inches) | Maximum (inches) |
| All Fabric Styles | 12 | 192 | 24 | 120 |

NOTE: Not available for 3/8" single cell.

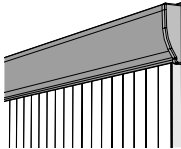
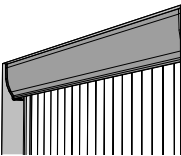
| Depth Requirements for Inside Mount: Slide-View Shades | | | | |
|--|---------------------------------|---|---|---|
| | | |  <p style="text-align: center;">Partially recessed headrail in window casing/ molding</p> |  <p style="text-align: center;">Fully recessed headrail in window casing/ molding</p> |
| | Cell Size (inches) | Headrail Dimensions (inches) | Minimum Depth Mount (inches) | Flush with Casing (inches) |
| Slide-View Shades | 1 1/4 Single Cell | 2 7/16 x 3 7/16 | 1 5/8 | 3 11/16 |
| | 1/2 Double Cell 3/4 Single Cell | 2 7/16 x 3 | 1 5/8 | 3 5/16 |

Options

Enhanced Light Control Features

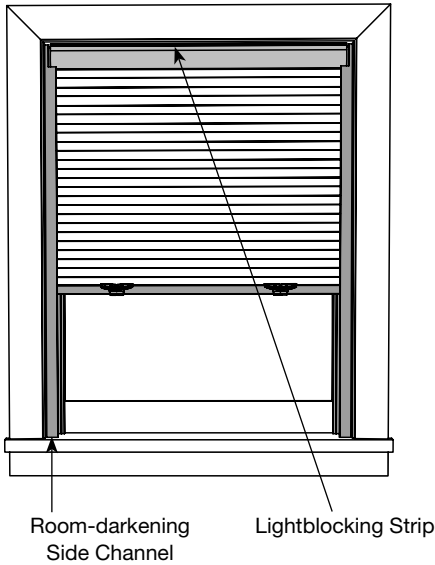

Lightblocking Strip

- Boost room-darkening performance by reducing light leakage between the window and headrail
- Ideal option for bedrooms, nurseries, and those who prefer blackout light control
- Available for cellular shades with cordless lift, continuous-loop lift, and motorized lift

Room-Darkening Side Channels

- **For surcharge, see price charts**
- Boost room-darkening performance by reducing light leakage at sides of shades between the fabric and window frame
- Maximizes privacy
- Ideal option for bedrooms, nurseries, and those who prefer enhanced light control
- Available for $\frac{3}{4}$ " single cell and $\frac{1}{2}$ " double cell cellular shades with cord lift and cordless lift controls
- Maximum width and height is 96" x 96"
- Rail colors are: Canyon Gray 053, Cream 715, Creamy Pearl 356, Revere Pewter 190, Sable 565, Smokey Gray 026, or White Satin 205, refer to "Cellular Shade Color Coordination Chart" for more information

Options

Corner Windows

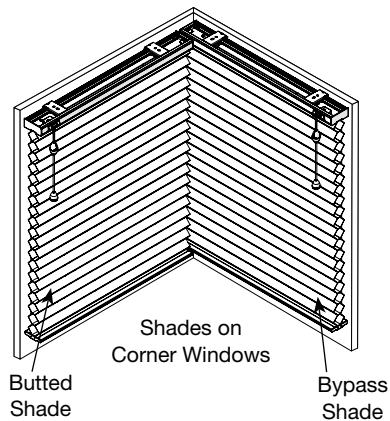

- **No charge**
- Made as individual shades
- Each shade will have its own control; we recommend opposite corners
- Indicate for each shade whether left or right and butt or bypass
- Bypass shade is mounted into the corner; butt shade is abutted to the other shade
- Manufacturer will take appropriate deductions for proper fit; DO NOT order as a corner shade if you do not want manufacturer to take deductions
- **Cornices are not available on corner windows**
- For bottom up/top down and sun up/sun down cord lift shades, the corner controls will be hard to reach
- For Slide-View™ shades, the handles between the bypass and butt shades will be offset 3/4" from each other for ease of operation

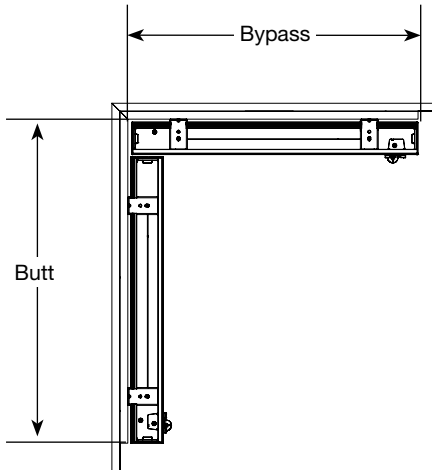

Measuring Information

Mounting on a Wall or Molding:

Measure the width of each window from the corner on the mounting surface (molding or wall) to the point you would like to cover.

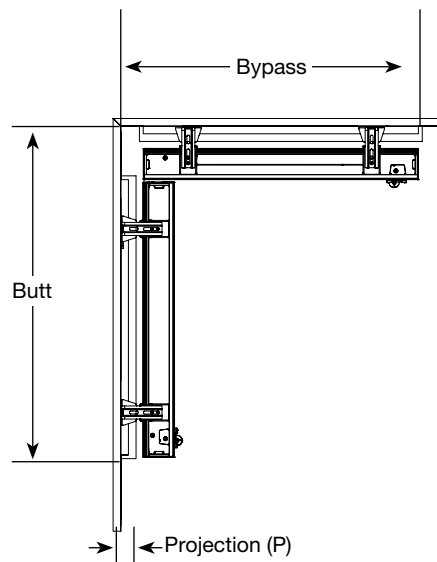

Mounting Above the Molding:

Measure the width of each window from the corner on the mounting surface to the point you would like to cover.

Projection measurement is the distance needed to clear any molding or obstructions that the shade will be mounted above.

NOTE: The projection (P) distance is needed to correctly calculate deductions for installations where the shades will use shims or projection brackets to clear molding. All projection distances must match for correct deductions to be calculated.

Options

Bay Windows

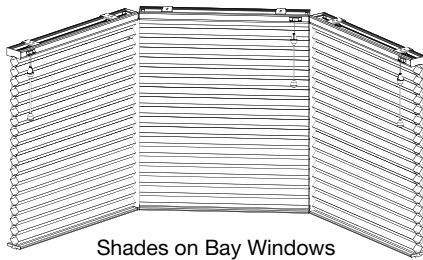

- **No charge**
- Made as individual shades
- Each section will have its own control
- Manufacturer will take appropriate deductions for proper fit; **DO NOT** order as a corner shade if you do not want manufacturer to take deductions
- **Cornices are not available on corner windows**
- For bottom up/top down and sun up/sun down with cord lift controls will be hard to reach
- For Slide-Vue™ shades there is a light gap between adjacent side rails

Measuring Information: Three-Sided Bay Window

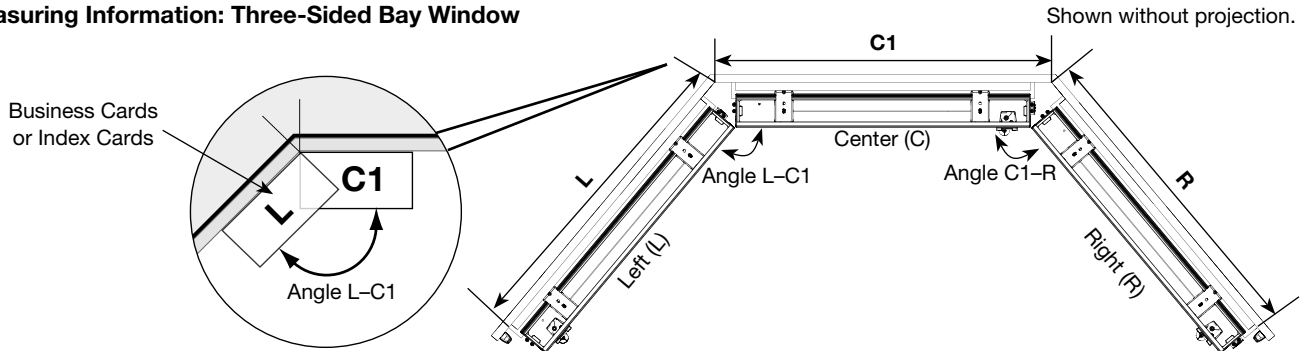

Measure:

L and R: Width of each side window from the corners on the mounting surface to the point you would like to cover.

C1: Width of the center window on the mounting surface from corner to corner.

Angle L-C1:

Angle C1-R:

Projection:

Angle between the (L) and (C1) windows.

Angle between the (C1) and (R) windows.

If needed: The depth of the trim or molding the shade will be mounted above.

Measuring Information: Four-Sided Bay Window

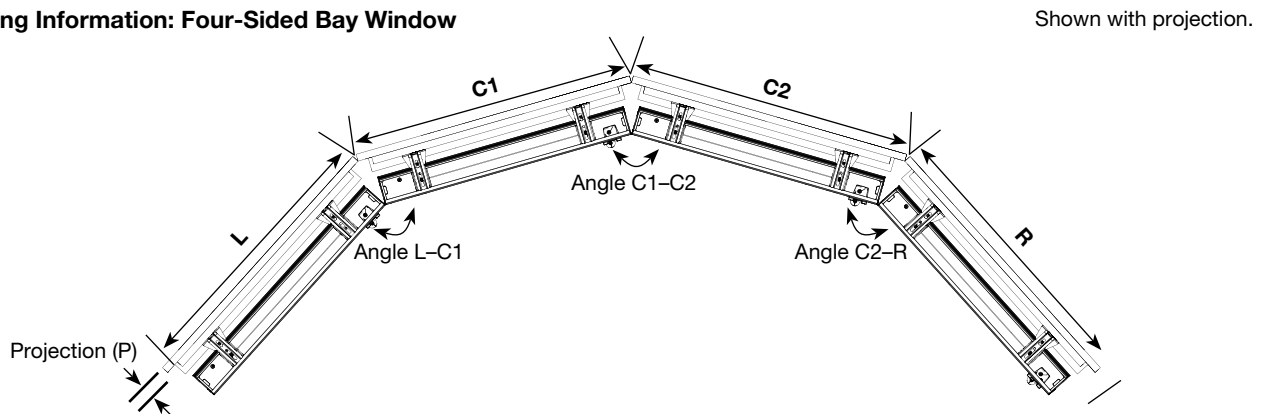

Measure:

L and R: Width of each side window from the corners on the mounting surface to the point you would like to cover.

C1, C2: Width of each center window on the mounting surface from corner to corner.

Angle L-C1:

Angle C1-C2:

Angle C2-R:

Projection:

Angle between the (L) and (C1) windows.

Angle between the (C1) and (C2) windows.

Angle between the (C2) and (R) windows.

If needed: The depth of the trim or molding the shade will be mounted above.

NOTE: The projection (P) distance is needed to correctly calculate deductions for installations where the shades will use shims or projection brackets to clear trim or molding. All projection distances must match for correct deductions to be calculated.

For additional windows on bays with up to five sides continue with number progression for center shade sizes (C1, C2, C3, ...) and angles (angle C1-C2, angle C2-C3, ...) as needed.

Measure each bay angle using a protractor or angle finder or use two business cards in each bay corner as illustrated above and fax to customer service 1-800-552-4559.

The angle to use between adjacent center bay windows along a straight section of wall is 180 degrees.

Options

Cut-Out Shades

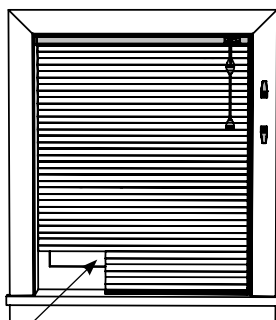

Without Intermediate Rail

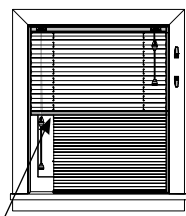

With Intermediate Rail

- Available with cord lift
- If cut-out width exceeds 1" or cut-out height exceeds 6", there will be an intermediate bottomrail with a separate control to operate the bottom panel
- Maximum width cut-out for shades less than or equal to 48" is 25% of the shade width, maximum cut-out for shades over 48" is 12"
- When ordering cut-out on each side of shade, both cut-outs must be same width and height
- Available as bottom corner cut-out only
- Cut-outs are measured from the bottom up
- Side mounts available up to 60" wide exact
- For rail color, refer to "Cellular Shade Color Coordination Chart"

| Size Considerations | Minimum Cut-Out (inches) | Minimum Width* (inches) | Maximum Width (inches) | Maximum Height (inches) |
|--|--------------------------|-------------------------|------------------------|-------------------------|
| All Fabric Styles (except 1¼" single cell) | ⅞ | 18 | 96 | 96 |

*For all inside mount applications, ⅜" deduction is taken on overall width.

SkyTrack™ Skylight

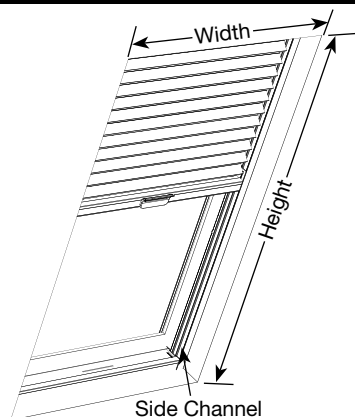

Side Channel

- Widths over 30¾" will have a center cord visible when the shade is open
- Operates with handle on center rail
- Brackets will be visible on an outside mount
- Skylight poles are telescoping and available upon request
- Side mounts not available
- Window top and bottom corners must be 90° (degrees)
- Available in ¾" single cell and ½" double cell
- Not available in cordless lift, continuous-loop lift, and motorized lift
- 90° (degree) corners at top and bottom are required for mounting
- For rail color, refer to "Cellular Shade Color Coordination Chart"

| Size Considerations | Minimum Recess (inches) | Flush Mount (inches) |
|---------------------|-------------------------|----------------------|
| Mounting Depth | 1⅞ | 2½ |

| Size Considerations | Minimum Width (inches) | Maximum Width* (inches) | Minimum Height (inches) | Maximum Height* (inches) |
|---------------------|------------------------|-------------------------|-------------------------|--------------------------|
| All Fabric Styles | 12¾ | 61 | 12 | 61 |

*For a width of 30¾" or less, maximum shade height is 96".

Sky Pole

Sizes available: 3 to 6½ feet and 5 to 9½ feet



Options

Specialty Shapes: Arch Shades

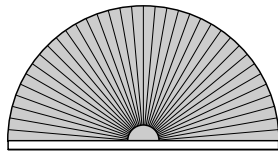

Perfect Arch: Half Circle

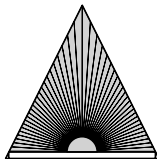

Triangle
(template required)

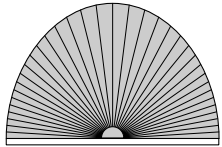

Palladian
(template required)
Illustration not to scale.

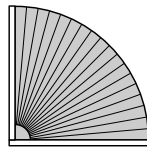

Quarter Circle
(template not required if perfect quarter)

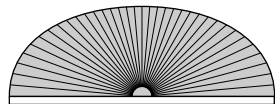

Eyebrow Arch
(template required)

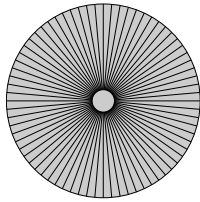

Full Circle
(template not required if perfect circle)

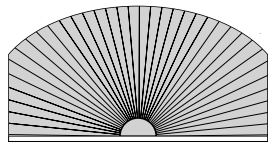

Elongated Arch
(arch with straight sides)
(template required)

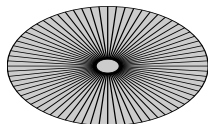

Non-perfect Circle
(=oval)

- Not available in 1¼" single cell
- Include width and height measurements on all orders
- For inside mount, measure inside of window frame; for outside mount, add the desired amount of overlap to your measurements
- All arches are stationary
- Outside mount brackets will be visible
- Side mounts available up to 60" wide exact

PERFECT ARCHES are those in which the radius of the circle is constant at all points (height is exactly one-half the width).

PERFECT QUARTER CIRCLE AND FULL CIRCLE are those in which the width and the height are the same.

NON-PERFECT ARCHES are not constant at all points. Deviation of even 1/16" makes it imperfect. Non-perfect quarter circles and circles are those where the width and height are different.

- All non-perfect arches require a template

Size Considerations

| Specialty | Minimum Width* (inches) | Maximum Width (inches) | Minimum Height (inches) | Maximum Height (inches) |
|---|-------------------------|------------------------|--------------------------|-------------------------|
| Half Circle | 9 | 84 | 4½ | 50½ |
| Palladian, Elongated, Eyebrow, and Triangle | 9 | 84 | 20% of width; minimum 4½ | 60% of width |
| Quarter Circle | 9 | 47 | 9 | 1½ times width |
| Full Circle | 9 | 36 of width total | 9 | 36 |

*For all inside mount applications—3/8" deduction is taken on overall width.

| Recess Depth and Flush Mount | Minimum Recess (inches) | Flush Mount (inches) |
|------------------------------|-------------------------|----------------------|
| 3/8" Cell Size | 1 1/16 | 1 15/16 |
| 1/2" and 3/4" Cell Size | 1 1/16 | 2 1/4 |

Specialty Shapes: Arch Over Standard Cord Lift Shade

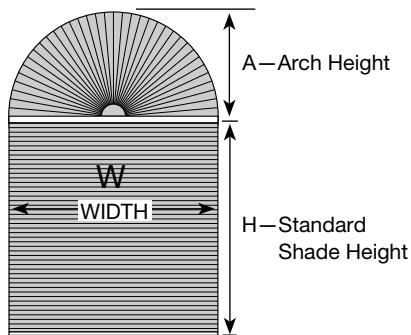

- **For pricing of arches, see arch pricing in price charts**
- Not available in 1¼" single cell
- If you want a single shade to cover the arch and standard portion of the window (without a separation between), order the shade as an "arch over standard cord lift"
- Arch over standard cord lift shades are made as one shade with no light gap between the arch and standard shade portions of the window
- The arch portion is fixed while the standard portion operates normally
- When ordering, provide the three measurements W, H, and A (shown to the left) along with a template of the arch portion if it is non-perfect
- Inside mount must be side mounted
- Arch and standard portion must have same width
- Template required for all non perfect arch over standard cord lift shades
- Arch over standard cord lift shades are only available as a cord lift shade or as a bottom up/top down cord lift shade
- Arch is inoperable

| | Minimum Shade and Arch Width* (inches) | Maximum Shade and Arch Width (inches) | Minimum Standard Shade Height (inches) | Maximum Height (inches) | Minimum Arch Height (inches) |
|----------------|--|---------------------------------------|--|-------------------------|------------------------------|
| Arch | 12 | 60 | 12 | 96 | 20% of width; minimum 4½ |
| Quarter Circle | 12 | 47 | 12 | 96 | 20% of width; minimum 9 |

*For all inside mount applications—3/8" deduction is taken on overall width

Options

Specialty Shapes: Octagon and Hexagon

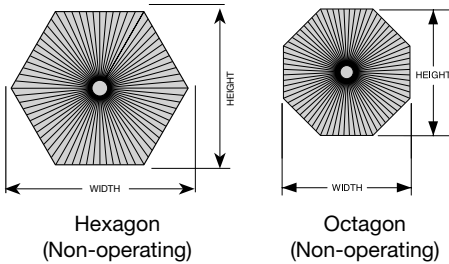

- Not available in 1¼" single cell
- Provide width and height at center of shade
- Octagon and hexagon require template
- Octagon and hexagon are stationary (no controls)

| | Minimum Total Width and Height (inches) | Maximum Total Width and Height (inches) |
|-------------------|---|---|
| All Fabric Styles | 9 | 36 |

Specialty Shapes: Trapezoids

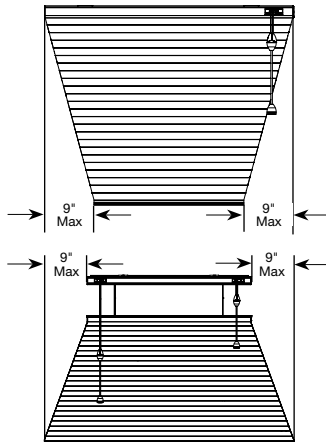

- Not available in 1¼" single cell
- Only available with cord lift option
- Trapezoids only open in direction of the longest rail; longest rail will be fixed
- Trapezoids with one straight side are not available
- Must provide measurements of all four sides; diagram with all dimensions noted is required
- Side mounts not available

| | Minimum Width and Height (inches) | Maximum Width of Long Rail (inches) | Maximum Difference Between Long and Short Rails on Each Side (inches) | Maximum Height (inches) |
|-------------------|-----------------------------------|-------------------------------------|---|-------------------------|
| All Fabric Styles | 12 | 74 | 12 | 96 |

Specialty Shapes: Angle Top/Angle Bottom

Short Side 4" and Over:

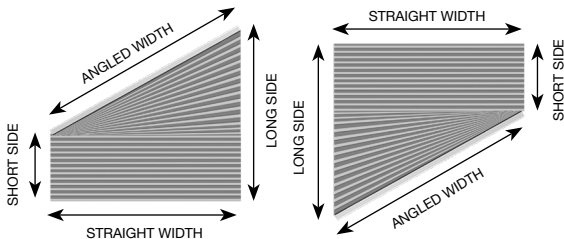

- Not available in 1¼" single cell
- Only available with cord lift option
- Specify angle top or angle bottom when ordering
- Angle top control must always be on the low side
- Angle bottom control can be in either the left or right; must specify
- Angle top not available with side mount
- Angle bottom is available with side mount up to 41" wide
- Only operable with short side heights 12" and greater. Only operates to the intermediate rail, will not completely lift to full angle, depending on degree of an angle; shade may be difficult to operate

Short Side 0" to 4":

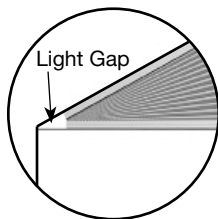

| Size Considerations | All Fabric Styles |
|--------------------------------------|--|
| Minimum Angled Width (inches) | 12 |
| Maximum Top Angle Width (inches) | 90 |
| Minimum Short Side of Angle (inches) | 0 |
| Maximum Bottom Angle Width (inches) | 41 |
| Minimum Long Side Height (inches) | 9 |
| Maximum Long Side Height (inches) | 96 |
| Maximum Angle Top Degree | 45° (degrees): ½" double cell ¾" single cell 60° (degrees): ¾" single cell |
| Maximum Angle Bottom Degree | 45° (degrees) |

NOTE: Angle top short side height of 12" or less will be stationary. As the short side measurement approaches 0" a light gap will exist to allow for the rails and fabrics to fit.

Options

Making a Template for Specialty Windows

1. Tape butcher paper, kraft, or construction paper over the window opening allowing plenty of overlap.
2. Being careful not to press against the template paper while tracing, draw an exact outline of the window opening. Pressing on the template paper may distort the paper and cause the wrong size to be made.
3. Remove the paper from the window opening. If the shade is an outside mount, add the desired amount of overlap to the window outline and draw a second outline around it to match the shape of the finished shade. Be sure to erase the inside line.
4. Mark the dimensions on the template. Check that the template dimensions match your measurements of the actual window opening.
NOTE: Make sure the template is of the window opening, not the glass only measurement.
5. Cut the shape from the paper.
6. PLACE THE TEMPLATE BACK INTO THE WINDOW OPENING TO CHECK FOR PROPER FIT COMPLETELY AROUND.
7. Indicate on the template
 - “Room side” and “top” on the template
 - Purchase order number
 - Customer’s name
 - Your store name and account number
8. Roll up template and place in a mailing tube. DO NOT FOLD TEMPLATE.

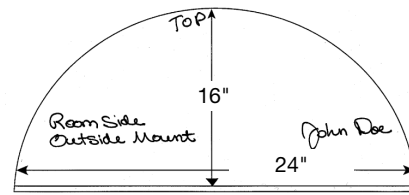

NOTE: This is just a sample for illustration purposes only—other information may be needed for your order.

Mail to: Springs Window Fashions, LLC
1500 Sycamore Road—G5
Montoursville, PA 17754
ATTN: Specialty Dept.

NOTE: When mailing, make sure to get a tracking number and note your return address on the mailing tube.

ACCEPTABLE MATERIALS FOR MAKING TEMPLATES:

- Kraft paper
- Butcher paper
- Construction paper

WE WILL NOT ACCEPT TEMPLATES MADE FROM THE FOLLOWING MATERIALS:

- Newspaper
- Plastic
- Wax paper
- Fabric
- Tissue paper
- Roofing paper
- Existing arch shades
- Wrapping paper
- Cardboard
- Poster board

NOTE: If the material used to make a template stretches, tears easily, will not lay flat, or will mark the fabric, IT WILL NOT BE USED.

Using a Template Service

For surcharge, see price charts

To use the template service, simply:

1. Select template service when entering your order online.
2. Use the template worksheet to determine what measurements you need to supply for each shape.
3. Enter the lettered measurements using line item comments. The comments have been preprogrammed to all of the measurements you need to enter for your special shape.

For additional information contact customer service.

General Information

Energy Performance

Graber® Cellular Shades are the smart choice for every window in your home. For year-round comfort, cellular shades effectively insulate your windows from the heat and cold. Regardless of climate, they are our most versatile and energy-saving window treatment available.

Sanctuary fabric is constructed with three layers made up of a 100% metalized polyester film sealed between two layers of soft, high-quality, 100% spunlace fabric. This unique design forms a soft, thick barrier of insulation. Independent tests prove Sanctuary ½" double cell fabric is one of our most insulating fabrics on the market.*

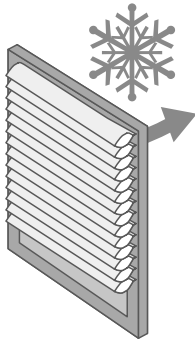

Block the Cold
Homes in colder climates benefit from cellular shades' insulating properties to block out the cold and regulate inside temperatures.
Sanctuary ½" double cell delivers a 22% reduction in heat transfer during the winter.*

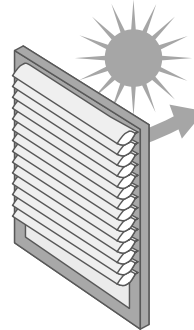

Block the Sun
Homes in warmer climates benefit from cellular shades' lightblocking properties to keep the heat from transferring to the inside.
Sanctuary ½" double cell delivers a 60% reduction in heat transfer during the summer.*

*Values listed are for Sanctuary ½" double cell. Based on third-party testing, Architectural Testing Incorporated (ATI).

Energy Efficiency Ratings

| Double Pane Low-E (Double Glazing) Window and Window Covering | | | | | |
|---|----------------|----------------------------|------------------------------|------------------------|------------------------------|
| Cell Size | Fabric | R-Value (higher is better) | % Reduction of Heat Transfer | SHGC (lower is better) | % Reduction of Heat Transfer |
| ½" Double Cell | Sanctuary | 4.76 | 22% | .12 | 60% |
| ¾" Single Cell | Sanctuary | 4.55 | 18% | .10 | 64% |
| ¾" Single Cell | Prestige BO | | | | |
| ¾" Single Cell | Montage BO | | | | |
| ¾" Single Cell | Enchantment BO | | | | |
| ¾" Single Cell | Infuse BO | 4.55 | 21% | .12 | 58% |
| 1¼" Single Cell | Sanctuary | | | | |
| ½" Double Cell | Splendor | 4.55 | 19% | .13 | 54% |
| ¾" Single Cell | Discovery | | | | |
| ¾" Single Cell | Discovery | | | | |
| ¾" Single Cell | Spendor | | | | |
| | Enchantment | | | | |
| | Scroll FR | | | | |
| | Infuse LF | | | | |
| 1¼" Single Cell | Splendor | 4.35 | 17% | .12 | 58% |
| ¾" Single Cell | Valletta | | | | |
| ¾" Single Cell | Couture LF | 4.17 | 13% | .15 | 47% |
| ¾" Single Cell | Couture BO | | | | |
| ¾" Single Cell | Endeavor | | | | |
| ¾" Single Cell | Endeavor | | | | |
| ¾" Single Cell | Kinsley LF | | | | |
| ¾" Single Cell | Kinsley BO | | | | |
| ¾" Single Cell | Simply Sheer | 4.00 | 10% | .19 | 30% |

NFRC 102 2010 performed by Architectural Testing Inc.

R-Value

R-Value indicates the effectiveness of the window covering at preventing energy from flowing to the outside. The higher the R-Value, the greater the insulating effectiveness.

Solar Heat Gain Coefficient (SHGC)

SHGC measures how well window covering blocks heat from the sun from flowing to the interior. SHGC is expressed as a number between 0 and 1. The lower the SHGC, the better a product is at blocking unwanted heat gain.

General Information

Stack Height Chart Cord Lift

| Total Thickness | | | | |
|--------------------------|---|---|--|--|
| Height of Shade (inches) | 1 1/4" Single Cell Sanctuary, Valletta 3/8" Single Cell Sanctuary, Scroll FR, Simply Sheer (inches) | 1 1/4" Single Cell Splendor 3/4" Single Cell Enchantment LF, Enchantment BO, Endeavor, Infuse BO, Kinsley BO, Montage LF, Montage BO, Prestige LF, Prestige BO 3/8" Single Cell Endeavor (inches) | 1/2" Double Cell Splendor 3/4" Single Cell Couture LF, Couture BO, Discovery, Infuse LF, Kinsley LF, Splendor, Valletta 3/8" Single Cell Discovery (inches) | 1/2" Double Cell Sanctuary (inches) |
| 18 | 2 1/2 | 2 5/8 | 2 7/8 | 3 |
| 30 | 2 5/8 | 2 3/4 | 3 1/4 | 3 1/2 |
| 42 | 2 3/4 | 3 | 3 1/2 | 3 5/8 |
| 54 | 2 7/8 | 3 1/8 | 3 3/8 | 4 5/8 |
| 66 | 3 | 3 3/8 | 4 1/4 | 4 3/4 |
| 78 | 3 1/8 | 3 1/2 | 4 1/2 | 5 1/8 |
| 90 | 3 3/8 | 3 3/4 | 4 7/8 | 5 5/8 |
| 96 | 3 3/8 | 3 7/8 | 5 | 5 7/8 |
| 106 | 3 1/2 | 4 | 5 5/8 | 6 1/4 |
| 120 | 3 3/8 | 4 1/4 | 5 3/4 | 6 5/8 |
| 132 | 3 7/8 | 4 5/8 | 6 | 7 1/8 |
| 144 | 4 | 4 5/8 | 6 5/8 | 7 1/2 |

NOTE: Stack height includes headrail and bottomrail.
 Sizes are approximate.

3/8" Single Cell, 1/2" Double Cell, and 3/4" Single Cell

All stack calculations are with standard control. For cordless, continuous-loop, and motorized lift controls, add 3/4".
 For bottom up/top down with standard control, add 1/4"; with cordless lift control, add 1 1/2".
 For sun up/sun down with standard control, add the two fabric stacks together and subtract 7/8" for the total stack height.
 For sun up/sun down with cordless lift control, add the two fabric stacks together.

1 1/4" Single Cell

All stack calculations are with cordless lift control. No changes are required for continuous-loop lift or motorized lift controls.
 For bottom up/top down with cordless lift control add 5/8".

General Information

Stack Height Chart: Perfect-Vue™

| All Pleated Fabrics Plus Cellular Fabrics Below | | | | |
|---|--|---|--|---|
| Height of Shade (inches) | ¾" Single Cell Sanctuary, Scroll FR, Simply Sheer (inches) | ¾" Single Cell Couture LF, Couture BO, Discovery, Enchantment LF, Enchantment BO, Endeavor, Infuse LF, Infuse BO, Kinsley LF, Kinsley BO, Montage LF, Montage BO, Prestige LF, Prestige BO, Splendor, Valletta ½" Double Cell Splendor (inches) | ¾" Single Cell Discovery, Endeavor (inches) | ½" Double Cell Sanctuary (inches) |
| 18 | 2 ⁵ / ₈ | 2 ³ / ₄ | 2 ³ / ₄ | 3 |
| 30 | 2 ⁷ / ₈ | 3 ¹ / ₄ | 3 ¹ / ₄ | 3 ¹ / ₂ |
| 42 | 3 ¹ / ₄ | 3 ³ / ₄ | 3 ⁷ / ₈ | 4 |
| 54 | 3 ⁵ / ₈ | 4 ¹ / ₈ | 4 ³ / ₈ | 4 ⁵ / ₈ |
| 66 | 4 | 4 ⁵ / ₈ | 4 ⁷ / ₈ | 5 ¹ / ₈ |
| 78 | 4 ³ / ₈ | 5 ¹ / ₈ | 5 ³ / ₈ | 5 ⁵ / ₈ |
| 90 | 4 ³ / ₄ | 5 ¹ / ₂ | 5 ⁷ / ₈ | 6 ¹ / ₄ |
| 96 | 4 ⁷ / ₈ | 5 ³ / ₄ | 6 ¹ / ₈ | 6 ¹ / ₂ |

NOTE: Sizes are approximate.

All stack calculations are with cord lift; for cordless lift add ¾".

Stack height includes all rails and both pleated and cellular fabrics together, but is based on the cellular fabric chosen.

Sheer pleated fabric was used for calculation.

General Information

Stack Width Chart Slide-Vue™

Height of shade is indicated across the top and width of shade is indicated on the left side of chart.

| Shade Stack Width Includes Side Rails | | | | | | | | | |
|---------------------------------------|--|------|---|------|-------------------------------------|------|--------------------------------------|-----|----|
| Width of Shade (inches) | 1¼" Single Cell Sanctuary, Splendor, Valletta | | ¾" Single Cell Couture LF, Couture BO, Discovery, Enchantment LF, Enchantment BO, Infuse LF, Infuse BO, Kinsley BO, Montage LF, Montage BO, Prestige LF, Prestige BO, Splendor, Valletta, Scroll FR (inches) | | ½" Double Cell Splendor (inches) | | ½" Double Cell Sanctuary (inches) | | |
| Height of Shade → (inches) | < 72 | 120* | < 72 | 120* | < 72 | 120* | < 72 | 120 | |
| Width of Shade (inches) | 72 | 9⅞ | 13 | 9⅞ | 13 | 9⅞ | 13 | 9⅞ | 13 |
| 84 | 9⅞ | 13 | 9⅞ | 13 | 9⅞ | 13 | 9⅞ | 13 | |
| 96 | 9⅞ | 13 | 9⅞ | 13 | 9⅞ | 13 | 9⅞ | 13 | |
| 108 | 9⅞ | 13 | 9⅞ | 13 | 9⅞ | 13 | 9⅞ | 13 | |
| 120 | 9⅞ | 13 | 9⅞ | 13 | 9⅞ | 13 | 9⅞ | 13 | |
| 132 | 9⅞ | 13 | 9⅞ | 13 | 9⅞ | 13 | 10⅞ | 13 | |
| 144 | 9⅞ | 13 | 9⅞ | 13 | 9⅞ | 13 | 10¾ | 13 | |
| 156 | 9⅞ | 13 | 9⅞ | 13 | 9¾ | 13 | 11⅞ | 13 | |
| 168 | 9⅞ | 13 | 9½ | 13 | 10⅞ | 13 | 12 | 13¼ | |
| 180 | 9½ | 13 | 9⅞ | 13 | 10¾ | 13 | 12⅞ | 14⅞ | |
| 192 | 9⅞ | 13 | 10¾ | 13 | 11⅞ | 13¾ | 13⅞ | 15 | |

NOTE: For a clear opening, stack width must be doubled.

Standard Handle Location for Slide-Vue

Standard Handle Location

- Up to 98" finished shade height the handle is centered on side rails
- 98⅞" to 120" finished shade height: the handle will be 48" from the bottom of the side rails

Special Handle Height Location

- For specifications see chart

| Slide-Vue Shade Special Handle Location Chart | | |
|---|---|---|
| Shade Height Less Than or Equal to (inches) | Minimum Handle Distance from Bottom of Shade (inches) | Maximum Handle Distance from Bottom of Shade (inches) |
| 24 to 36 | 11 | 16 |
| 36⅞ to 46 | 11 | 28 |
| 46⅞ to 62 | 13 | 38 |
| 62⅞ to 74 | 15 | 30 |
| 74⅞ to 86 | 15 | 36 |
| 86⅞ to 98 | 15 | 42 |
| 98⅞ to 108 | 34 | 49 |
| 108⅞ to 120 | 46 | 50 |

NOTE: Handle height is to center of handle.

General Information

Cellular Shade Color Coordination Chart

| Color Name | Default Rail Color Coordination | Color Number | Default Slide-Vue™ and Side Channel Color Name | Color Number |
|-------------------|---------------------------------|--------------|--|--------------|
| Splendor | | | | |
| Aqua Glow | White Satin | 205 | White Satin | 205 |
| Arctic White | Cream | 715 | Cream | 715 |
| Blue Breeze | White Satin | 205 | White Satin | 205 |
| Caribou | Camel | 086 | Sable | 565 |
| Champagne | Cream | 715 | Cream | 715 |
| Chocolate Cupcake | Arctic Seal | 183 | Sable | 565 |
| Coastal Nuance | Cream | 715 | Cream | 715 |
| Cool Amethyst | White Satin | 205 | White Satin | 205 |
| Cornerstone | Quietude | 188 | Creamy Pearl | 356 |
| Dark Taupe | Tender Taupe | 103 | Sable | 565 |
| Eggnog | Creamy Pearl | 356 | Creamy Pearl | 356 |
| Elusive Gray | White Satin | 205 | White Satin | 205 |
| Endless Summer | Open Seas | 186 | White Satin | 205 |
| Freshwater Pearl | White Satin | 205 | White Satin | 205 |
| Gentle Beige | Lamplight | 904 | Cream | 715 |
| Gentle Tan | Revere Pewter | 190 | Revere Pewter | 190 |
| Golden Wheat | Camel | 086 | Cream | 715 |
| Gray Dusk | Arctic Seal | 183 | White Satin | 205 |
| Gray Fedora | Black Satin | 233 | White Satin | 205 |
| Gray Mystique | Smokey Gray | 026 | Smokey Gray | 026 |
| Gray Violet | Iris | 080 | White Satin | 205 |
| Harvested Wheat | Twine | 439 | Cream | 715 |
| Hushed Gray | Canyon Gray | 053 | Canyon Gray | 053 |
| Irish Coffee | Sable | 565 | Sable | 565 |
| Light Azure | Robin's Egg | 075 | White Satin | 205 |
| Liquid Silver | Smokey Gray | 026 | Smokey Gray | 026 |
| Liquid Silver | Smokey Gray | 026 | Canyon Gray | 053 |
| London Skies | Canyon Gray | 053 | Canyon Gray | 053 |
| Midnight Sky | Mysterious | 152 | White Satin | 205 |
| Natural Beige | Lamplight | 904 | Cream | 715 |
| Navy Charm | Navy | 369 | White Satin | 205 |
| Nostalgic Beige | Sand | 701 | Creamy Pearl | 356 |
| Peacock Plume | Black Satin | 233 | White Satin | 205 |
| Pink Rose | White Satin | 205 | White Satin | 205 |
| Powder Gray | White Satin | 205 | White Satin | 205 |
| Quiet Gray | Smokey Gray | 026 | Smokey Gray | 026 |
| Rich Burgundy | Bordeaux | 359 | White Satin | 205 |
| River Delta | Acacia Haze | 182 | Smokey Gray | 026 |
| River Stone | Canyon Gray | 053 | Canyon Gray | 053 |
| Sandpiper | Creamy Pearl | 356 | Creamy Pearl | 356 |
| Sculpture Gray | Revere Pewter | 190 | Revere Pewter | 190 |
| Seascape | Robin's Egg | 075 | White Satin | 205 |
| Shell White | Cream | 715 | Cream | 715 |
| Shoreline Sand | Quietude | 188 | Creamy Pearl | 356 |
| Smoky Quartz | Iron Gate | 185 | Sable | 565 |
| Sweetwater Sage | Acacia Haze | 182 | Smokey Gray | 026 |
| Timberwolf Gray | Smokey Gray | 026 | Smokey Gray | 026 |
| Tonal Taupe | Tender Taupe | 103 | Sable | 565 |
| Tuscan Red | Clover | 049 | White Satin | 205 |
| Umber | Praline | 108 | Sable | 565 |
| Villa | Revere Pewter | 190 | Revere Pewter | 190 |
| Whisper White | White Satin | 205 | White Satin | 205 |

General Information

Cellular Shade Color Coordination Chart (continued)

| Color Name | Default Rail Color Coordination | Color Number | Default Slide-Vue™ and Side Channel Color Name | Color Number |
|------------------|---------------------------------|--------------|--|--------------|
| Sanctuary | | | | |
| Arctic White | Cream | 715 | Cream | 715 |
| Blue Breeze | White Satin | 205 | White Satin | 205 |
| Caribou | Camel | 086 | Sable | 565 |
| Champagne | Cream | 715 | Cream | 715 |
| Cool Amethyst | White Satin | 205 | White Satin | 205 |
| Cornerstone | Quietude | 188 | Creamy Pearl | 356 |
| Dark Taupe | Tender Taupe | 103 | Sable | 565 |
| Eggnog | Creamy Pearl | 356 | Creamy Pearl | 356 |
| Elusive Gray | White Satin | 205 | White Satin | 205 |
| Freshwater Pearl | White Satin | 205 | White Satin | 205 |
| Gentle Beige | Lamplight | 904 | Cream | 715 |
| Gentle Tan | Revere Pewter | 190 | Revere Pewter | 190 |
| Golden Wheat | Camel | 086 | Cream | 715 |
| Gray Fedora | Black Satin | 233 | White Satin | 205 |
| Gray Mystique | Smokey Gray | 026 | Smokey Gray | 026 |
| Harvested Wheat | Twine | 439 | Cream | 715 |
| Hushed Gray | Canyon Gray | 053 | Canyon Gray | 053 |
| Irish Coffee | Sable | 565 | Sable | 565 |
| Light Azure | Robin's Egg | 075 | White Satin | 205 |
| Liquid Silver | Smokey Gray | 026 | Smokey Gray | 026 |
| Midnight Sky | Mysterious | 152 | White Satin | 205 |
| Navy Charm | Navy | 369 | White Satin | 205 |
| Nostalgic Beige | Sand | 701 | Creamy Pearl | 356 |
| Pink Rose | White Satin | 205 | White Satin | 205 |
| Powder Gray | White Satin | 205 | White Satin | 205 |
| Rich Burgundy | Bordeaux | 359 | White Satin | 205 |
| River Delta | Acacia Haze | 182 | Smokey Gray | 026 |
| River Stone | Canyon Gray | 053 | Canyon Gray | 053 |
| Sandpiper | Creamy Pearl | 356 | Creamy Pearl | 356 |
| Sculpture Gray | Revere Pewter | 190 | Revere Pewter | 190 |
| Seascape | Robin's Egg | 075 | White Satin | 205 |
| Shell White | Cream | 715 | Cream | 715 |
| Shoreline Sand | Quietude | 188 | Creamy Pearl | 356 |
| Smoky Quartz | Iron Gate | 185 | Sable | 565 |
| Sweetwater Sage | Acacia Haze | 182 | Smokey Gray | 26 |
| Timberwolf Gray | Smokey Gray | 026 | Smokey Gray | 026 |
| Tuscan Red | Clover | 049 | White Satin | 205 |
| Umber | Praline | 108 | Sable | 565 |
| Villa | Revere Pewter | 190 | Revere Pewter | 190 |
| Whisper White | White Satin | 205 | White Satin | 205 |
| Endeavor | | | | |
| Atlantic Frost | White Satin | 205 | White Satin | 205 |
| Barnwood | Iron Gate | 185 | Canyon Gray | 053 |
| Brown Squirrel | Revere Pewter | 190 | Revere Pewter | 190 |
| Canadian Tuxedo | Navy | 369 | White Satin | 205 |
| Elegant Dove | Smokey Gray | 026 | Smokey Gray | 026 |
| Gingerroot | Lamplight | 904 | Creamy Pearl | 356 |
| Lime Chiffon | White Satin | 205 | White Satin | 205 |
| Llama | Cream | 715 | Cream | 715 |
| Pier | Lamplight | 904 | Cream | 715 |
| Soft Coal | Arctic Seal | 183 | White Satin | 205 |
| Thickened Cream | Cream | 715 | Cream | 715 |
| White Radish | White Satin | 205 | White Satin | 205 |
| Discovery | | | | |
| Barnwood | Iron Gate | 185 | Canyon Gray | 053 |
| Elegant Dove | Smokey Gray | 026 | Smokey Gray | 026 |
| Gingerroot | Lamplight | 904 | Creamy Pearl | 356 |
| Llama | Cream | 715 | Cream | 715 |
| Pier | Lamplight | 904 | Cream | 715 |
| White Radish | White Satin | 205 | White Satin | 205 |

General Information

Cellular Shade Color Coordination Chart (continued)

| Color Name | Default Rail Color Coordination | Color Number | Default Slide-Vue™ and Side Channel Color Name | Color Number |
|---|---------------------------------|--------------|--|--------------|
| Couture Light Filtering/Couture Blackout | | | | |
| Feather White | White Satin | 205 | White Satin | 205 |
| Heron Plume | Twine | 439 | Creamy Pearl | 356 |
| Jute | Iron Gate | 185 | Canyon Gray | 053 |
| Noble Pewter | Smokey Gray | 026 | Smokey Gray | 026 |
| Peaceful Gray | Canyon Gray | 053 | Canyon Gray | 053 |
| Valletta | | | | |
| Adirondack | Tender Taupe | 103 | Sable | 565 |
| Atlantic Frost | White Satin | 205 | White Satin | 205 |
| Cinnamon Spice | Praline | 108 | Sable | 565 |
| Coconut Cream | Cream | 715 | Cream | 715 |
| Crisp Carbon | Arctic Seal | 183 | White Satin | 205 |
| Manila | Creamy Pearl | 356 | Creamy Pearl | 356 |
| Simply White | White Satin | 205 | White Satin | 205 |
| Spring Fawn | Twine | 439 | Creamy Pearl | 356 |
| Trevi | Canyon Gray | 053 | Canyon Gray | 053 |
| Walnut Shell | Sable | 565 | Sable | 565 |
| Prestige Light Filtering/Prestige Blackout | | | | |
| Beige Influence | Canyon Gray | 053 | Canyon Gray | 053 |
| Gray Juniper | Smokey Gray | 026 | Smokey Gray | 026 |
| Pale Pebble | White Satin | 205 | White Satin | 205 |
| Refined Flax | Revere Pewter | 190 | Revere Pewter | 190 |
| Sophisticated Stone | Canyon Gray | 053 | Canyon Gray | 053 |
| Montage Light Filtering/Montage Blackout | | | | |
| Chroma Gray | Canyon Gray | 053 | Canyon Gray | 053 |
| Cultivated Khaki | Revere Pewter | 190 | Revere Pewter | 190 |
| Gray Granite | White Satin | 205 | White Satin | 205 |
| Gray Hues | Online | 187 | Smokey Gray | 026 |
| Gray Moon | Canyon Gray | 053 | Canyon Gray | 053 |
| Enchantment Light Filtering/Enchantment Blackout | | | | |
| Genteel Beige | Revere Pewter | 190 | Revere Pewter | 190 |
| Glacial Gray | White Satin | 205 | White Satin | 205 |
| Regal Gray | Revere Pewter | 190 | Revere Pewter | 190 |
| Ridged Sand | Revere Pewter | 190 | Revere Pewter | 190 |
| Silver Shadow | White Satin | 205 | White Satin | 205 |
| Infuse Light Filtering/Infuse Blackout | | | | |
| Aspen | White Satin | 205 | White Satin | 205 |
| Autumn Gold | Camel | 086 | Creamy Pearl | 356 |
| Balanced Beige | Revere Pewter | 190 | Revere Pewter | 190 |
| Ecu | Creamy Pearl | 356 | Creamy Pearl | 356 |
| Indigo Intrigue | Navy | 369 | White Satin | 205 |
| Rivermist | Online | 187 | Smokey Gray | 026 |
| Savvy Slate | Arctic Seal | 183 | White Satin | 205 |
| Subtle Sage | Acacia Haze | 182 | Smokey Gray | 026 |
| Taupe Perfection | Tender Taupe | 103 | Sable | 565 |
| Vanilla Cream | Cream | 715 | Cream | 715 |
| Kinsley Light Filtering/Kinsley Blackout | | | | |
| Aspen | White Satin | 205 | White Satin | 205 |
| Autumn Gold | Camel | 086 | Creamy Pearl | 356 |
| Balanced Beige | Revere Pewter | 190 | Revere Pewter | 190 |
| Ecu | Creamy Pearl | 356 | Creamy Pearl | 356 |
| Indigo Intrigue | Navy | 369 | White Satin | 205 |
| Rivermist | Online | 187 | Smokey Gray | 026 |
| Savvy Slate | Arctic Seal | 183 | White Satin | 205 |
| Subtle Sage | Acacia Haze | 182 | Smokey Gray | 026 |
| Taupe Perfection | Tender Taupe | 103 | Sable | 565 |
| Vanilla Cream | Cream | 715 | Cream | 715 |

General Information

| Color Name | Default Rail Color Coordination | Color Number | Default Slide-View™ and Side Channel Color Name | Color Number |
|---------------------|---------------------------------|--------------|---|--------------|
| Scroll FR | | | | |
| Adirondack | Tender Taupe | 103 | Sable | 565 |
| Manila | Creamy Pearl | 356 | Creamy Pearl | 356 |
| Simply White | White Satin | 205 | White Satin | 205 |
| Spring Fawn | Twine | 439 | Creamy Pearl | 356 |
| Trevi | Canyon Gray | 053 | Canyon Gray | 053 |
| Simply Sheer | | | | |
| Almond | Creamy Pearl | 356 | Creamy Pearl | 356 |
| Mocha | Beige | 011 | Sable | 565 |
| Whisper | White Satin | 205 | White Satin | 205 |

General Information

Cord Lift Product Detail

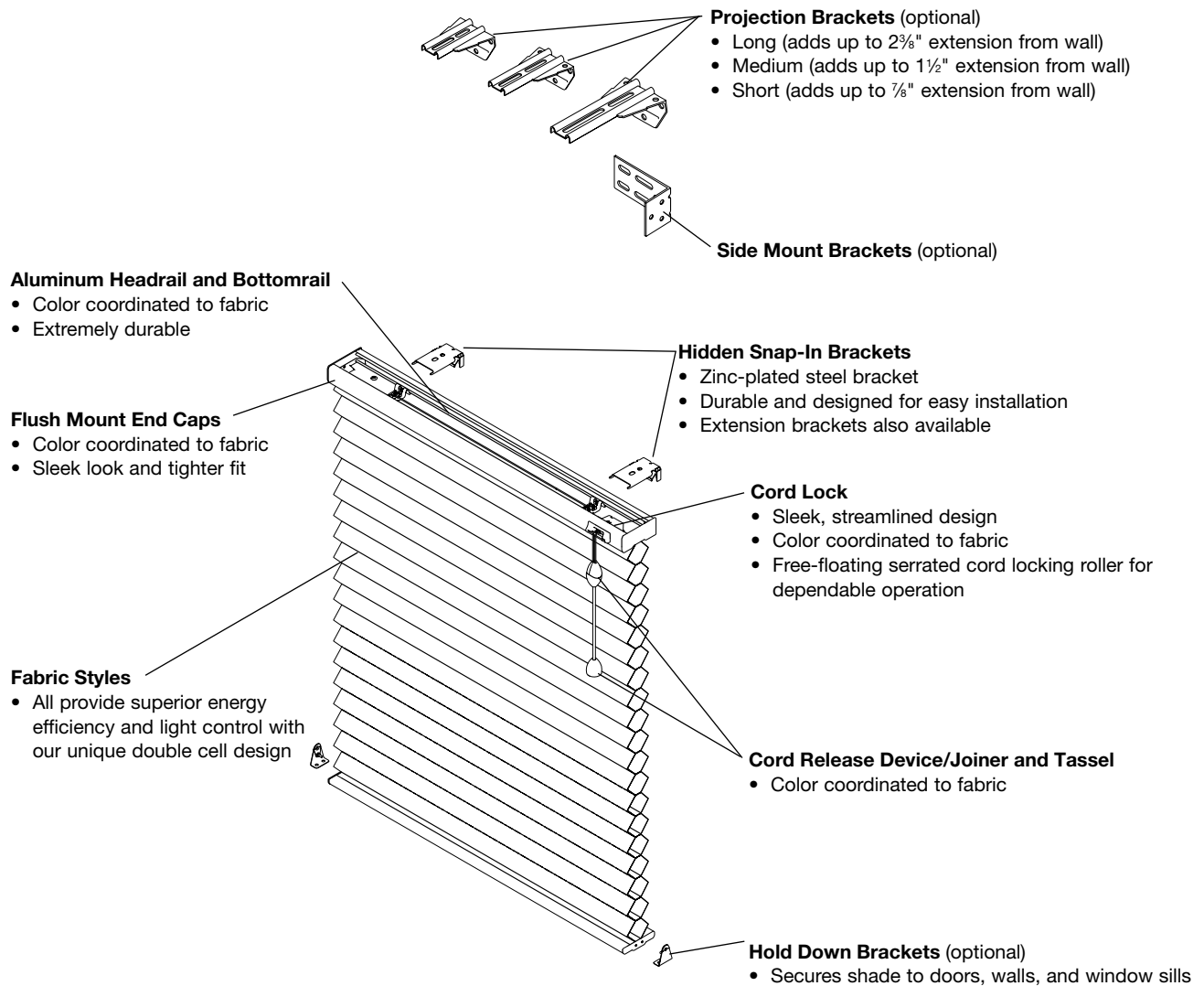

Cord Management Options

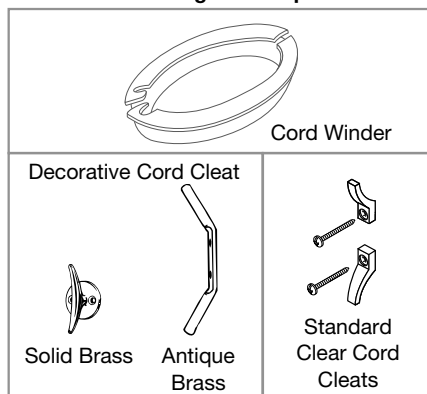

General Information

Cordless Lift Product Detail

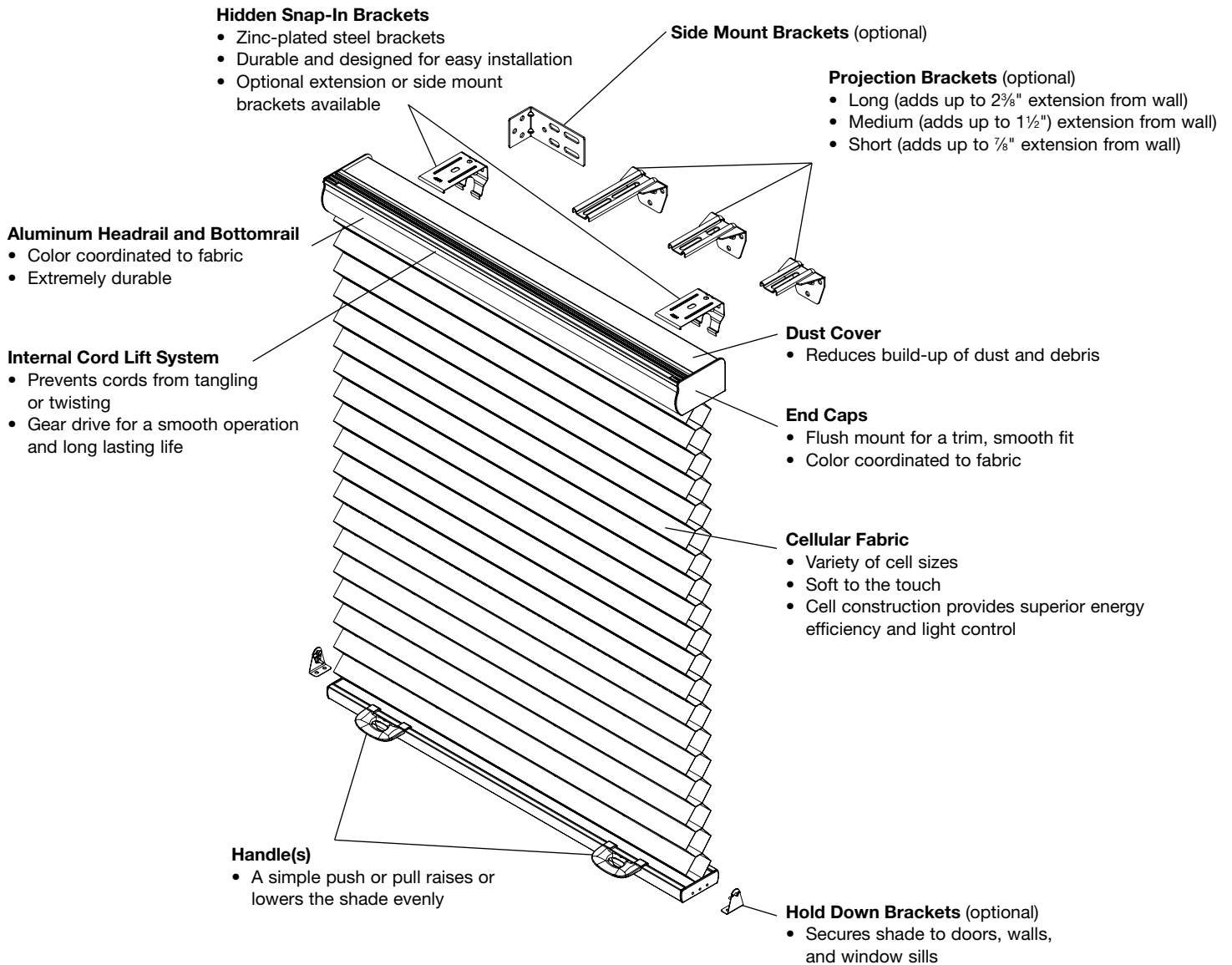

NOTE: All cordless lift shades need to be used on windows where consumers can comfortably raise and lower the shade with their hands and have easy access. Suggest adding a sky pole for hard-to-reach applications, up to 24" wide. Two sky poles are recommended to ensure even operation for shades over 24" wide.

General Information

Continuous-Loop Lift Product Detail

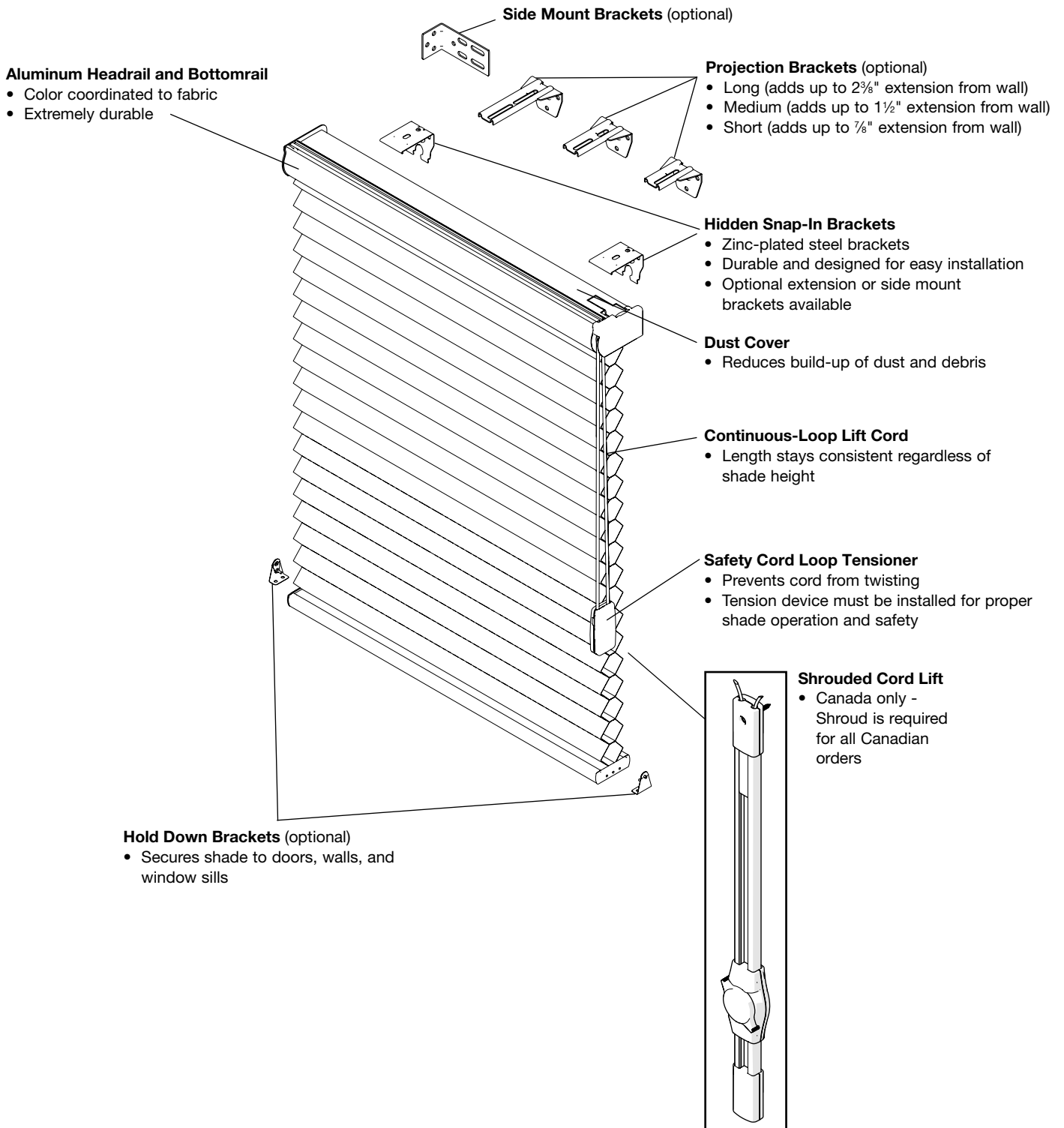

General Information

Bottom Up/Top Down Cord Lift Product Detail

Aluminum Headrail

- Color coordinated to fabric
- Headrail and intermediate rail nest to prevent light gaps

Hidden Snap-In Brackets

- Zinc-plated steel bracket
- Durable and designed for easy installation

Cord Locks

- Sleek, streamlined design
- Color coordinated to fabric
- Free-floating serrated cord locking roller for dependable operation

Pull Cord

- Allows for conventional shade operation

Cord Release Device/Joiner Ball and Tassel

- Color coordinated to fabric

Cord Release Device

- Color coordinated to fabric

Aluminum Intermediate Rail and Bottomrail

- Color coordinated to fabric
- Extremely durable

Hold Down Brackets (optional)

- Secures shade to doors, walls, and window sills

Cord Management Options

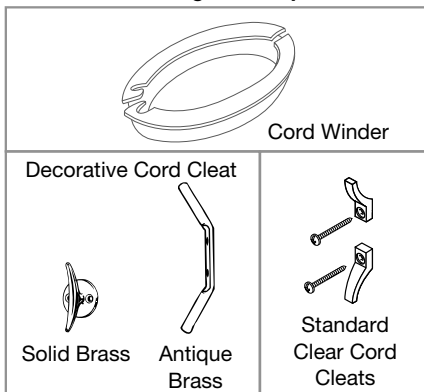

General Information

Bottom Up/Top Down Cordless Lift Product Detail

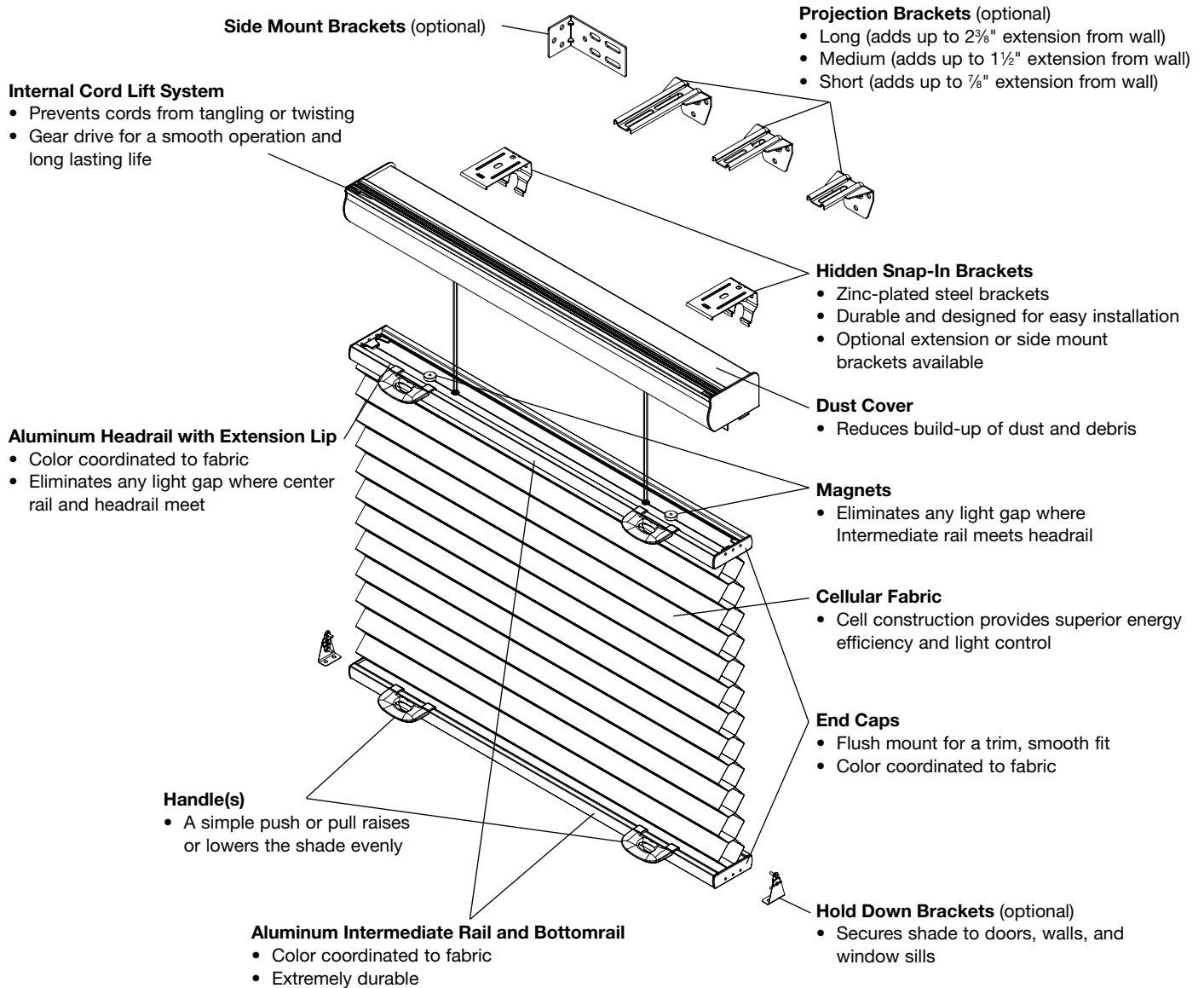

NOTE: All cordless lift shades need to be used on windows where consumers can comfortably raise and lower the shade with their hands and have easy access.

General Information

Cord Lift Product Detail Perfect-Vue™

Aluminum Headrail

- Headrail coordinates with pleated fabric
- Extremely durable

Cord Release Device

- Color coordinated to cord
- Cords coordinate with pleated fabric

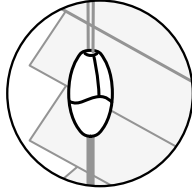

Fabric Styles

- Soft to the touch
- All cellular fabrics provide superior energy efficiency and light control, especially with our unique double cell design
- Pleated fabric offers the ultimate in style, privacy, and light control options

Intermediate Rail and Bottomrail

- Intermediate rail coordinates with pleated fabric
- Bottomrail coordinates with cellular fabric
- Extremely durable

Projection Brackets (optional)

- Long (adds up to 2 $\frac{3}{8}$ " extension from wall)
- Medium (adds up to 1 $\frac{1}{2}$ " extension from wall)
- Short (adds up to $\frac{7}{8}$ " extension from wall)

Hidden Snap-In Brackets

- Zinc-plated steel
- Durable brackets designed for easy installation
- Projection brackets also available

Flush Mount End Caps

- Color coordinated to rails
- Sleeker look and tighter fit

Cord Locks

- Sleek, streamlined design
- Color coordinated to headrail
- Free-floating serrated cord locking roller for dependable operation
- Standard control is right control—operates bottomrail, while left control operates intermediate rail

Cord Release Device/Joiner Ball and Tassle

- Color coordinated to cord
- Cords coordinate with pleated fabric

Hold Down Brackets (optional)

- Secures shade to doors, walls, and window sills

View From Back of Shade

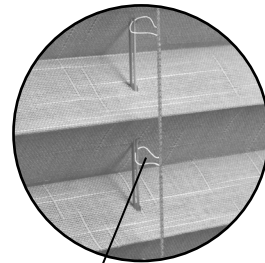

EvenPleat® (optional)

EvenPleat offers a unique ladder system to guarantee pleats will not flatten.

General Information

Cordless Lift Product Detail Perfect-Vue™

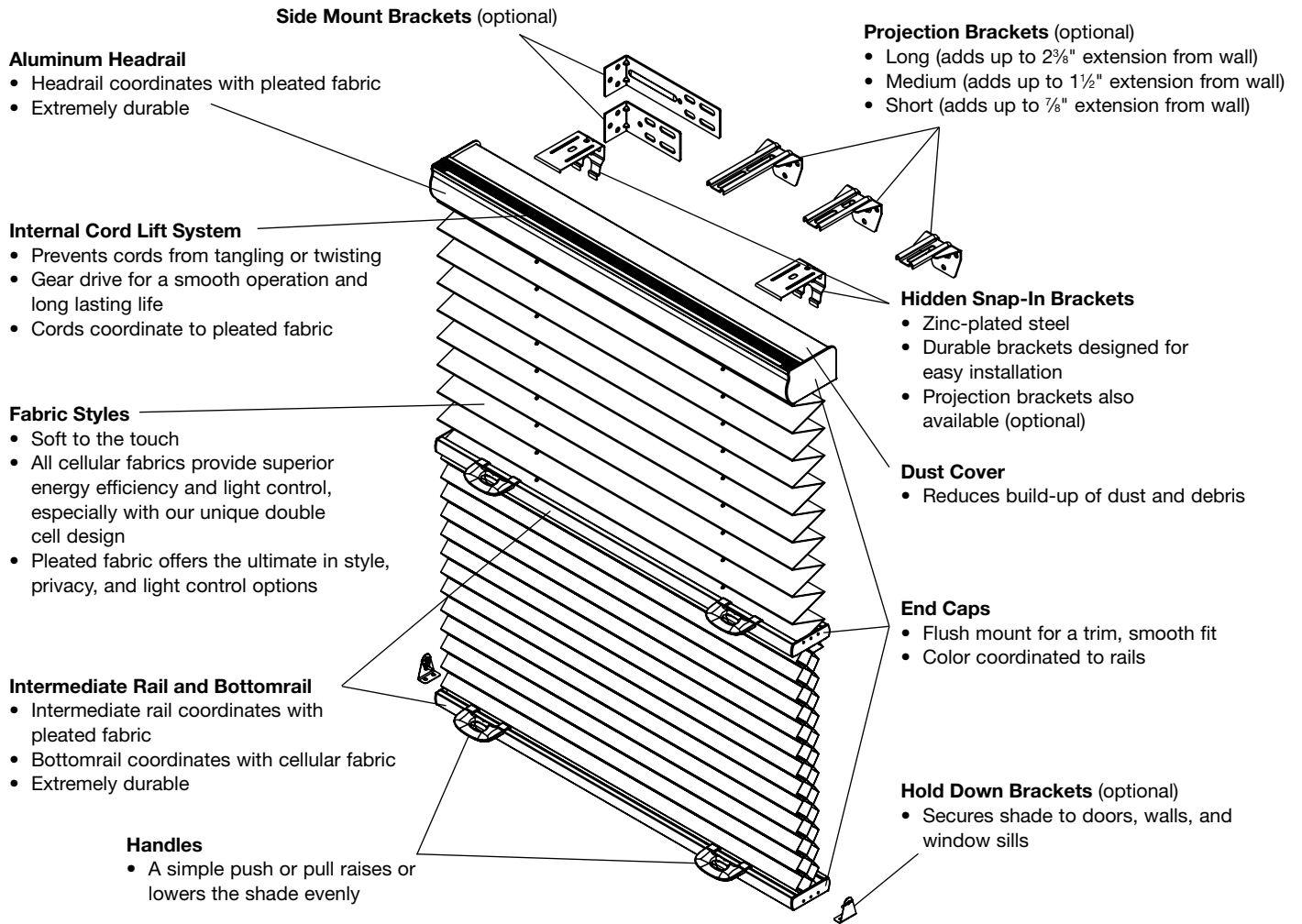

View from Back of Shade

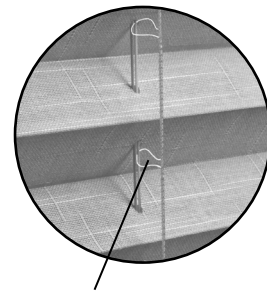

EvenPleat® (optional)
EvenPleat offers a unique ladder system to guarantee pleats will not flatten.

NOTE: All cordless lift shades need to be used on windows where consumers can comfortably raise and lower the shade with their hands and have easy access.

General Information

Arch Over Standard Cord Lift Product Detail

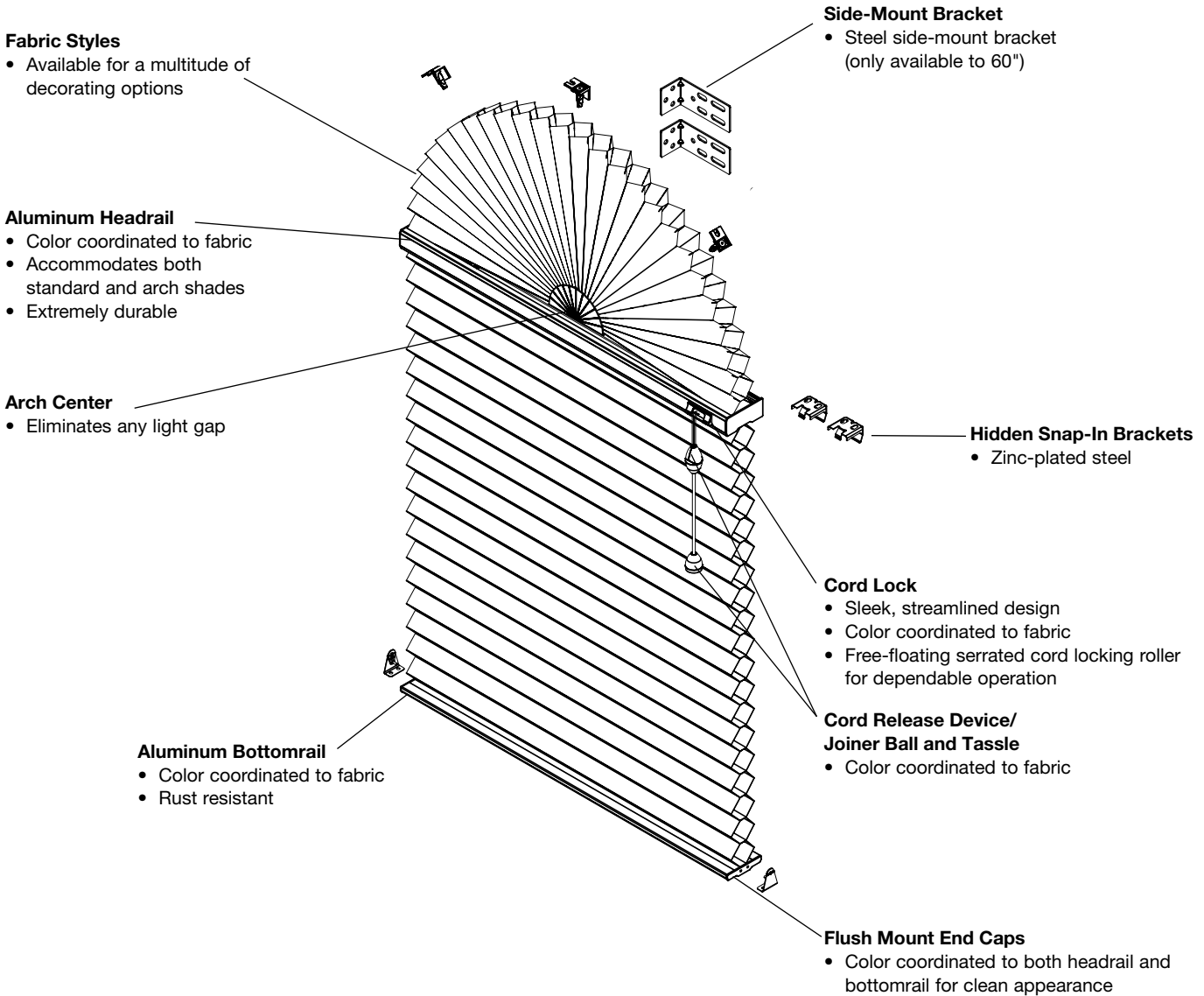

Cord Management Options

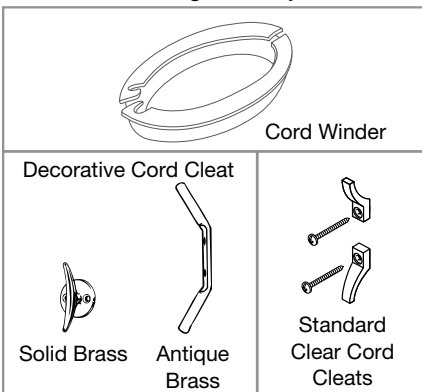

General Information

Slide-View™ Product Detail

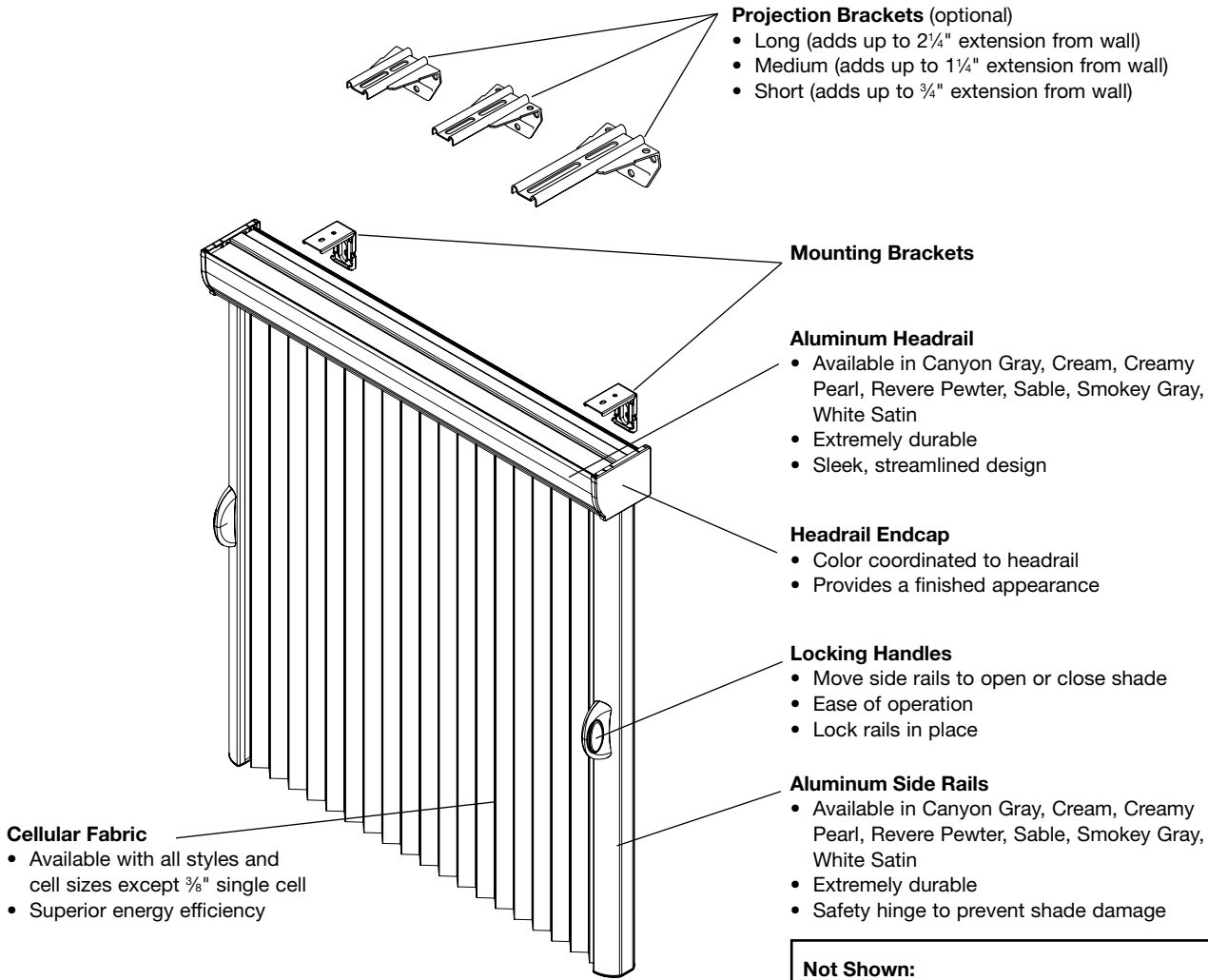

- Projection Brackets** (optional)
- Long (adds up to 2¼" extension from wall)
 - Medium (adds up to 1¼" extension from wall)
 - Short (adds up to ¾" extension from wall)

Mounting Brackets

Aluminum Headrail

- Available in Canyon Gray, Cream, Creamy Pearl, Revere Pewter, Sable, Smokey Gray, White Satin
- Extremely durable
- Sleek, streamlined design

Headrail Endcap

- Color coordinated to headrail
- Provides a finished appearance

Locking Handles

- Move side rails to open or close shade
- Ease of operation
- Lock rails in place

Aluminum Side Rails

- Available in Canyon Gray, Cream, Creamy Pearl, Revere Pewter, Sable, Smokey Gray, White Satin
- Extremely durable
- Safety hinge to prevent shade damage

Cellular Fabric

- Available with all styles and cell sizes except ¾" single cell
- Superior energy efficiency

Application:

- Ideal for patio doors, wide windows, and room dividers
- Movable side rails with locking handles for ease of operation
- Allows stack of material to be positioned on the right, center, or left
- Easy to install
- Slim, compact stack

Not Shown:

Safety release fabric stem
 Releases from carriage to prevent fabric from tearing

Cornices or valances (optional)
 Refer to the cornices and valances product information guide for product specifications

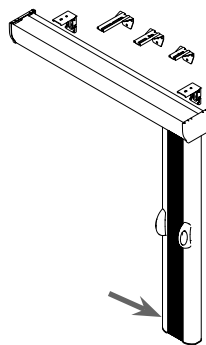

Stack Right

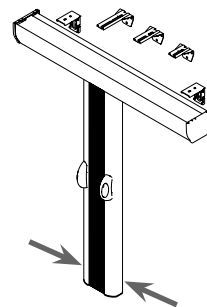

Stack Center

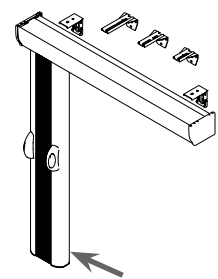

Stack Left

GRABER®

Grabber is a brand of Springs Window Fashions, the Best Experience Company

Grabber and the Grabber logo are registered trademarks of Springs Window Fashions, LLC.

(2/22) | 22-313252

GRABER.

Grabber CrystalPleat® Cellular Shades

Designer US Price List — Effective June 2022

Price Group A: Endeavor 3/8" (1.0 cm) Single Cell

| Height up to inches (cm) ↓ | Width up to inches (cm) → | | | | | | | | | | | | | | | | | |
|-------------------------------|---------------------------|--------------|--------------|---------------|-------------|---------------|---------------|---------------|---------------|---------------|---------------|----------------|----------------|----------------|----------------|--------------|----------------|--|
| | 24 (61) | 30 (76.2) | 36 (91.5) | 42 (106.7) | 48 (122) | 54 (137.2) | 60 (152.4) | 66 (167.7) | 72 (182.9) | 84 (213.4) | 96 (243.9) | 108 (274.4) | 120 (304.8) | 132 (335.3) | 144 (365.8) | 174 (442) | 192 (487.7) | |
| 36 (91.5) | 176 | 191 | 220 | 244 | 275 | 296 | 318 | 345 | 368 | 426 | 480 | 593 | 642 | 696 | 743 | 847 | 956 | |
| 42 (106.7) | 185 | 213 | 237 | 271 | 296 | 322 | 356 | 383 | 411 | 464 | 515 | 653 | 709 | 769 | 821 | 935 | 1033 | |
| 48 (122) | 199 | 225 | 261 | 292 | 318 | 356 | 384 | 417 | 448 | 512 | 576 | 705 | 769 | 834 | 898 | 1026 | 1163 | |
| 54 (137.2) | 214 | 238 | 278 | 311 | 345 | 383 | 415 | 452 | 484 | 554 | 630 | 763 | 831 | 899 | 969 | 1109 | 1265 | |
| 60 (152.4) | 223 | 261 | 296 | 333 | 368 | 409 | 448 | 484 | 521 | 603 | 680 | 818 | 895 | 969 | 1048 | 1202 | 1371 | |
| 66 (167.7) | 236 | 275 | 314 | 356 | 399 | 435 | 480 | 520 | 565 | 646 | 735 | 878 | 957 | 1037 | 1121 | 1290 | 1468 | |
| 72 (182.9) | 244 | 290 | 333 | 375 | 426 | 464 | 511 | 554 | 600 | 692 | 787 | 935 | 1020 | 1106 | 1199 | 1379 | 1569 | |
| 78 (198.2) | 261 | 304 | 352 | 400 | 448 | 498 | 546 | 592 | 636 | 733 | 839 | 994 | 1085 | 1177 | 1282 | 1464 | 1670 | |
| 84 (213.4) | 271 | 314 | 367 | 417 | 477 | 524 | 573 | 627 | 676 | 775 | 887 | 1054 | 1153 | 1252 | 1351 | 1545 | 1778 | |
| 90 (228.6) | 280 | 333 | 385 | 435 | 502 | 554 | 608 | 660 | 714 | 818 | 940 | 1106 | 1217 | 1318 | 1428 | 1635 | 1881 | |
| 96 (243.9) | 294 | 352 | 405 | 459 | 524 | 580 | 639 | 696 | 754 | 865 | 991 | 1171 | 1283 | 1394 | 1503 | 1726 | 1980 | |
| 108 (274.4) | 317 | 384 | 446 | 510 | 574 | 642 | 704 | 769 | 834 | 956 | 1098 | 1289 | 1413 | 1539 | 1662 | 1908 | 2196 | |
| 120 (304.8) | 345 | 415 | 484 | 554 | 630 | 701 | 769 | 839 | 910 | 1049 | 1202 | 1398 | 1541 | 1673 | 1816 | 2097 | 2403 | |
| 132 (335.3) | 368 | 448 | 521 | 600 | 677 | 761 | 835 | 911 | 986 | 1138 | 1302 | 1519 | 1669 | 1821 | 1971 | 2276 | 2603 | |
| 144 (365.8) | 400 | 482 | 565 | 642 | 733 | 818 | 898 | 979 | 1064 | 1229 | 1406 | 1635 | 1797 | 1960 | 2124 | 2455 | 2815 | |

NOTE: Cordless lift maximum height is 86" (218.5 cm). Cordless lift continuous shades available in outlined area above.

NOTE: Continuous width fabric up to 144" (365.8 cm).

| Endeavor 3/8" Single Cell* | | | | | |
|----------------------------|------|--------------|------|-----------------|------|
| Atlantic Frost | 5824 | Elegant Dove | 5816 | Pier | 5805 |
| Barnwood | 5814 | Gingerroot | 5810 | Soft Coal | 5818 |
| Brown Squirrel | 5813 | Lime Chiffon | 5831 | Thickened Cream | 5802 |
| Canadian Tuxedo | 5826 | Llama | 5801 | White Radish | 5800 |

*Color coordinated with Discovery (blackout)

Price Group B: Endeavor 3/4" (2.0 cm) Single Cell

| Height up to inches (cm) ↓ | Width up to inches (cm) → | | | | | | | | | | | | | | | | |
|-------------------------------|---------------------------|--------------|--------------|---------------|-------------|---------------|---------------|---------------|---------------|---------------|---------------|----------------|----------------|----------------|----------------|--------------|----------------|
| | 24 (61) | 30 (76.2) | 36 (91.5) | 42 (106.7) | 48 (122) | 54 (137.2) | 60 (152.4) | 66 (167.7) | 72 (182.9) | 84 (213.4) | 96 (243.9) | 108 (274.4) | 120 (304.8) | 132 (335.3) | 144 (365.8) | 174 (442) | 192 (487.7) |
| 36 (91.5) | 187 | 208 | 234 | 262 | 291 | 313 | 342 | 366 | 392 | 449 | 508 | 626 | 679 | 736 | 785 | 898 | 1011 |
| 42 (106.7) | 198 | 223 | 256 | 283 | 313 | 345 | 373 | 405 | 436 | 494 | 547 | 683 | 751 | 809 | 866 | 988 | 1097 |
| 48 (122) | 213 | 238 | 274 | 309 | 342 | 373 | 406 | 439 | 475 | 543 | 614 | 749 | 810 | 881 | 950 | 1084 | 1230 |
| 54 (137.2) | 224 | 257 | 294 | 329 | 366 | 405 | 438 | 477 | 513 | 587 | 668 | 805 | 880 | 953 | 1028 | 1174 | 1338 |
| 60 (152.4) | 236 | 274 | 313 | 354 | 392 | 431 | 475 | 513 | 552 | 635 | 722 | 864 | 948 | 1028 | 1106 | 1270 | 1449 |
| 66 (167.7) | 254 | 291 | 333 | 373 | 418 | 461 | 508 | 550 | 593 | 680 | 776 | 922 | 1013 | 1101 | 1184 | 1363 | 1557 |
| 72 (182.9) | 262 | 307 | 354 | 402 | 449 | 494 | 540 | 583 | 631 | 729 | 831 | 988 | 1078 | 1171 | 1267 | 1459 | 1664 |
| 78 (198.2) | 274 | 318 | 370 | 419 | 475 | 526 | 573 | 625 | 675 | 775 | 887 | 1052 | 1145 | 1251 | 1353 | 1549 | 1772 |
| 84 (213.4) | 283 | 333 | 389 | 439 | 503 | 556 | 609 | 664 | 717 | 822 | 940 | 1116 | 1217 | 1325 | 1426 | 1634 | 1879 |
| 90 (228.6) | 296 | 354 | 408 | 461 | 528 | 583 | 643 | 697 | 753 | 864 | 994 | 1171 | 1285 | 1396 | 1508 | 1728 | 1990 |
| 96 (243.9) | 312 | 370 | 427 | 489 | 556 | 615 | 677 | 736 | 797 | 915 | 1049 | 1234 | 1354 | 1471 | 1588 | 1824 | 2094 |
| 108 (274.4) | 337 | 406 | 471 | 539 | 610 | 679 | 745 | 810 | 881 | 1011 | 1162 | 1360 | 1494 | 1623 | 1764 | 2022 | 2323 |
| 120 (304.8) | 366 | 438 | 513 | 583 | 668 | 740 | 810 | 887 | 962 | 1109 | 1270 | 1478 | 1629 | 1774 | 1922 | 2215 | 2541 |
| 132 (335.3) | 392 | 475 | 552 | 631 | 720 | 804 | 884 | 963 | 1041 | 1202 | 1377 | 1609 | 1771 | 1925 | 2087 | 2401 | 2757 |
| 144 (365.8) | 419 | 509 | 593 | 679 | 775 | 864 | 950 | 1034 | 1124 | 1301 | 1487 | 1728 | 1899 | 2075 | 2245 | 2596 | 2976 |

NOTE: Cordless lift maximum height is 86" (218.5 cm). Cordless lift continuous shades available in outlined area above.

NOTE: Continuous width fabric up to 144" (365.8 cm).

| Endeavor 3/4" Single Cell* | | | | | |
|----------------------------|------|--------------|------|-----------------|------|
| Atlantic Frost | 0370 | Elegant Dove | 0374 | Pier | 0378 |
| Barnwood | 0371 | Gingerroot | 0375 | Soft Coal | 0379 |
| Brown Squirrel | 0372 | Lime Chiffon | 0376 | Thickened Cream | 0380 |
| Canadian Tuxedo | 0373 | Llama | 0377 | White Radish | 0381 |

*Color coordinated with Discovery (blackout)

Price Group C: Splendor 3/4" (2.0 cm) Single Cell

| Height up to inches (cm) ↓ | Width up to inches (cm) → | | | | | | | | | | | | | | | | |
|-------------------------------|---------------------------|--------------|--------------|---------------|-------------|---------------|---------------|---------------|---------------|---------------|---------------|----------------|----------------|----------------|----------------|--------------|----------------|
| | 24 (61) | 30 (76.2) | 36 (91.5) | 42 (106.7) | 48 (122) | 54 (137.2) | 60 (152.4) | 66 (167.7) | 72 (182.9) | 84 (213.4) | 96 (243.9) | 108 (274.4) | 120 (304.8) | 132 (335.3) | 144 (365.8) | 174 (442) | 192 (487.7) |
| 36 (91.5) | 239 | 268 | 306 | 343 | 378 | 407 | 440 | 477 | 511 | 581 | 656 | 813 | 884 | 953 | 1022 | 1164 | 1317 |
| 42 (106.7) | 259 | 291 | 331 | 369 | 407 | 447 | 489 | 521 | 564 | 643 | 711 | 893 | 972 | 1050 | 1125 | 1289 | 1420 |
| 48 (122) | 270 | 313 | 353 | 399 | 440 | 489 | 525 | 571 | 614 | 706 | 800 | 970 | 1055 | 1145 | 1232 | 1407 | 1596 |
| 54 (137.2) | 292 | 333 | 382 | 430 | 477 | 521 | 570 | 621 | 664 | 764 | 867 | 1049 | 1144 | 1242 | 1334 | 1526 | 1735 |
| 60 (152.4) | 309 | 352 | 407 | 459 | 511 | 564 | 614 | 664 | 720 | 826 | 940 | 1124 | 1229 | 1334 | 1435 | 1654 | 1878 |
| 66 (167.7) | 320 | 378 | 433 | 489 | 547 | 602 | 657 | 713 | 771 | 885 | 1009 | 1202 | 1319 | 1428 | 1544 | 1771 | 2018 |
| 72 (182.9) | 343 | 398 | 459 | 516 | 581 | 642 | 699 | 763 | 825 | 948 | 1080 | 1286 | 1401 | 1523 | 1645 | 1893 | 2160 |
| 78 (198.2) | 355 | 418 | 482 | 549 | 619 | 683 | 746 | 811 | 876 | 1009 | 1153 | 1372 | 1487 | 1620 | 1750 | 2017 | 2300 |
| 84 (213.4) | 369 | 436 | 506 | 571 | 651 | 723 | 794 | 860 | 925 | 1063 | 1220 | 1445 | 1580 | 1724 | 1855 | 2127 | 2440 |
| 90 (228.6) | 388 | 459 | 527 | 603 | 690 | 763 | 833 | 907 | 980 | 1124 | 1293 | 1523 | 1668 | 1814 | 1960 | 2245 | 2582 |
| 96 (243.9) | 404 | 480 | 555 | 636 | 721 | 802 | 878 | 954 | 1034 | 1186 | 1366 | 1607 | 1753 | 1909 | 2064 | 2374 | 2724 |
| 108 (274.4) | 422 | 506 | 591 | 669 | 764 | 850 | 933 | 1014 | 1099 | 1262 | 1454 | 1698 | 1870 | 2032 | 2199 | 2525 | 2900 |
| 120 (304.8) | 459 | 549 | 642 | 732 | 831 | 924 | 1014 | 1107 | 1200 | 1384 | 1585 | 1853 | 2035 | 2216 | 2399 | 2768 | 3173 |
| 132 (335.3) | 491 | 592 | 692 | 792 | 899 | 1006 | 1102 | 1201 | 1302 | 1496 | 1724 | 2005 | 2207 | 2401 | 2604 | 3000 | 3442 |
| 144 (365.8) | 525 | 640 | 745 | 850 | 968 | 1080 | 1186 | 1294 | 1404 | 1620 | 1860 | 2160 | 2378 | 2586 | 2809 | 3242 | 3717 |

NOTE: Cordless lift maximum height is 86" (218.5 cm). Cordless lift continuous shades available in outlined area above.

NOTE: Continuous width fabric up to 144" (365.8 cm).

| Splendor 3/4" Single Cell* | | | | | |
|----------------------------|------|-----------------|------|-----------------|------|
| Aqua Glow | 1369 | Gray Mystique | 1354 | Sandpiper | 1371 |
| Arctic White | 1333 | Gray Violet | 1341 | Sculpture Gray | 1359 |
| Blue Breeze | 1349 | Harvested Wheat | 1331 | Seascape | 1352 |
| Caribou | 1337 | Hushed Gray | 1373 | Shell White | 1345 |
| Champagne | 1336 | Irish Coffee | 1324 | Shoreline Sand | 1332 |
| Chocolate Cupcake | 1365 | Light Azure | 1348 | Smoky Quartz | 1353 |
| Coastal Nuance | 1357 | Liquid Silver | 1320 | Sweetwater Sage | 1344 |
| Cool Amethyst | 1362 | London Skies | 1361 | Timberwolf Gray | 1325 |
| Cornerstone | 1372 | Midnight Sky | 1330 | Tonal Taupe | 1363 |
| Dark Taupe | 1360 | Natural Beige | 1326 | Tuscan Red | 1342 |
| Eggnog | 1328 | Navy Charm | 1351 | Umber | 1370 |
| Elusive Gray | 1367 | Nostalgic Beige | 1343 | Villa | 1323 |
| Endless Summer | 1356 | Peacock Plume | 1364 | Whisper White | 1321 |
| Freshwater Pearl | 1322 | Pink Rose | 1350 | | |
| Gentle Beige | 1340 | Powder Gray | 1334 | | |
| Gentle Tan | 1329 | Quiet Gray | 1327 | | |
| Golden Wheat | 1355 | Rich Burgundy | 1347 | | |
| Gray Dusk | 1335 | River Delta | 1339 | | |
| Gray Fedora | 1338 | River Stone | 1368 | | |

*Color coordinated with Sanctuary (blackout)

Price Group D: Discovery 3/8" (1.0 cm) Single Cell, Splendor 1/2" (1.3 cm) Double Cell, Enchantment Light Filtering 3/4" (2.0 cm) Single Cell, Montage Light Filtering 3/4" (2.0 cm) Single Cell, Prestige Light Filtering 3/4" (2.0 cm) Single Cell

Width up to inches (cm) →

| Height up to inches (cm) ↓ | 24 (61) | 30 (76.2) | 36 (91.5) | 42 (106.7) | 48 (122) | 54 (137.2) | 60 (152.4) | 66 (167.7) | 72 (182.9) | 84 (213.4) | 96 (243.9) | 108 (274.4) | 120 (304.8) | 132 (335.3) | 144 (365.8) | 174 (442) | 192 (487.7) |
|----------------------------|---------|-----------|-----------|------------|----------|------------|------------|------------|------------|------------|------------|-------------|-------------|-------------|-------------|-----------|-------------|
| 36 (91.5) | 259 | 291 | 329 | 368 | 407 | 441 | 479 | 516 | 552 | 628 | 712 | 884 | 962 | 1031 | 1109 | 1262 | 1422 |
| 42 (106.7) | 280 | 313 | 361 | 402 | 441 | 484 | 531 | 569 | 610 | 695 | 765 | 967 | 1055 | 1137 | 1225 | 1396 | 1540 |
| 48 (122) | 296 | 339 | 386 | 431 | 479 | 529 | 573 | 623 | 666 | 761 | 863 | 1054 | 1142 | 1241 | 1335 | 1527 | 1730 |
| 54 (137.2) | 313 | 363 | 412 | 465 | 516 | 569 | 618 | 676 | 718 | 828 | 941 | 1135 | 1237 | 1344 | 1444 | 1657 | 1879 |
| 60 (152.4) | 331 | 382 | 441 | 497 | 552 | 609 | 666 | 718 | 779 | 895 | 1020 | 1223 | 1331 | 1445 | 1558 | 1793 | 2035 |
| 66 (167.7) | 350 | 407 | 467 | 531 | 593 | 653 | 714 | 776 | 839 | 962 | 1091 | 1303 | 1430 | 1546 | 1670 | 1918 | 2187 |
| 72 (182.9) | 368 | 430 | 497 | 567 | 628 | 695 | 758 | 824 | 890 | 1026 | 1172 | 1394 | 1516 | 1653 | 1784 | 2053 | 2341 |
| 78 (198.2) | 389 | 452 | 524 | 593 | 675 | 740 | 805 | 880 | 950 | 1091 | 1246 | 1485 | 1615 | 1756 | 1897 | 2186 | 2497 |
| 84 (213.4) | 402 | 472 | 546 | 623 | 704 | 783 | 857 | 933 | 1006 | 1154 | 1321 | 1568 | 1715 | 1868 | 2016 | 2305 | 2645 |
| 90 (228.6) | 418 | 497 | 574 | 654 | 746 | 824 | 908 | 981 | 1066 | 1220 | 1400 | 1653 | 1812 | 1966 | 2123 | 2434 | 2801 |
| 96 (243.9) | 436 | 524 | 601 | 692 | 780 | 867 | 953 | 1032 | 1118 | 1289 | 1483 | 1737 | 1903 | 2070 | 2239 | 2573 | 2954 |
| 108 (274.4) | 457 | 546 | 636 | 729 | 828 | 920 | 1012 | 1104 | 1191 | 1370 | 1571 | 1840 | 2023 | 2201 | 2382 | 2734 | 3147 |
| 120 (304.8) | 497 | 596 | 694 | 792 | 900 | 1005 | 1104 | 1197 | 1297 | 1499 | 1720 | 2002 | 2202 | 2406 | 2599 | 2999 | 3438 |
| 132 (335.3) | 535 | 639 | 749 | 857 | 972 | 1087 | 1196 | 1303 | 1413 | 1628 | 1867 | 2175 | 2391 | 2605 | 2823 | 3250 | 3729 |
| 144 (365.8) | 572 | 692 | 804 | 920 | 1051 | 1172 | 1289 | 1403 | 1523 | 1756 | 2017 | 2343 | 2575 | 2807 | 3044 | 3516 | 4025 |

NOTE: Cordless lift maximum height is 86" (218.5 cm). Cordless lift continuous shades available in outlined area above.

NOTE: Continuous width fabric up to 144" (365.8 cm).

| Discovery 3/8" Single Cell* | | | | | |
|-----------------------------|------|------------|------|--------------|------|
| Barnwood | 5214 | Gingerroot | 5210 | Pier | 5205 |
| Elegant Dove | 5216 | Llama | 5201 | White Radish | 5200 |

*Color coordinated with Endeavor (light filtering)

| Splendor 1/2" Double Cell** | | | | | |
|-----------------------------|------|-----------------|------|-----------------|------|
| Aqua Glow | 1569 | Gray Dusk | 1535 | Quiet Gray | 1527 |
| Arctic White | 1533 | Gray Fedora | 1538 | Rich Burgundy | 1547 |
| Blue Breeze | 1549 | Gray Mystique | 1554 | River Delta | 1539 |
| Caribou | 1537 | Gray Violet | 1541 | River Stone | 1568 |
| Champagne | 1536 | Harvested Wheat | 1531 | Sandpiper | 1571 |
| Chocolate Cupcake | 1565 | Hushed Gray | 1573 | Sculpture Gray | 1559 |
| Coastal Nuance | 1557 | Irish Coffee | 1524 | Seascape | 1552 |
| Cool Amethyst | 1562 | Light Azure | 1548 | Shell White | 1545 |
| Cornerstone | 1572 | Liquid Silver | 1520 | Shoreline Sand | 1532 |
| Dark Taupe | 1560 | London Skies | 1561 | Smoky Quartz | 1553 |
| Eggnog | 1528 | Midnight Sky | 1530 | Sweetwater Sage | 1544 |
| Elusive Gray | 1567 | Natural Beige | 1526 | Timberwolf Gray | 1525 |
| Endless Summer | 1556 | Navy Charm | 1551 | Tonal Taupe | 1563 |
| Freshwater Pearl | 1522 | Nostalgic Beige | 1543 | Tuscan Red | 1542 |
| Gentle Beige | 1540 | Peacock Plume | 1564 | Umber | 1570 |
| Gentle Tan | 1529 | Pink Rose | 1550 | Villa | 1523 |
| Golden Wheat | 1555 | Powder Gray | 1534 | Whisper White | 1521 |

**Color coordinated with Sanctuary (blackout)

| Enchantment Light Filtering 3/4" Single Cell | | | | | |
|--|------|-------------|------|---------------|------|
| Genteel Beige | 0620 | Regal Gray | 0621 | Silver Shadow | 0622 |
| Glacial Gray | 0623 | Ridged Sand | 0624 | | |

*Color coordinated with Enchantment Blackout

| Montage Light Filtering 3/4" Single Cell | | | | | |
|--|------|--------------|------|-----------|------|
| Chroma Gray | 0613 | Gray Granite | 0610 | Gray Moon | 0612 |
| Cultivated Khaki | 0611 | Gray Hues | 0614 | | |

*Color coordinated with Montage Blackout

| Prestige Light Filtering 3/4" Single Cell | | | | | |
|---|------|--------------|------|---------------------|------|
| Beige Influence | 0590 | Refined Flax | 0592 | Sophisticated Stone | 0591 |
| Gray Juniper | 0594 | Pale Pebble | 0593 | | |

*Color coordinated with Prestige Blackout

Price Group E: Discovery ¾" (2.0 cm) Single Cell, Scroll FR ¾" (2.0 cm) Single Cell

| Height up to inches (cm) ↓ | Width up to inches (cm) → | | | | | | | | | | | | | | | | |
|-------------------------------|---------------------------|--------------|--------------|---------------|-------------|---------------|---------------|---------------|---------------|---------------|---------------|----------------|----------------|----------------|----------------|--------------|----------------|
| | 24 (61) | 30 (76.2) | 36 (91.5) | 42 (106.7) | 48 (122) | 54 (137.2) | 60 (152.4) | 66 (167.7) | 72 (182.9) | 84 (213.4) | 96 (243.9) | 108 (274.4) | 120 (304.8) | 132 (335.3) | 144 (365.8) | 174 (442) | 192 (487.7) |
| 36 (91.5) | 267 | 294 | 336 | 378 | 417 | 448 | 486 | 525 | 564 | 640 | 724 | 898 | 971 | 1050 | 1124 | 1282 | 1451 |
| 42 (106.7) | 284 | 319 | 362 | 409 | 448 | 491 | 537 | 574 | 621 | 711 | 780 | 982 | 1072 | 1158 | 1242 | 1416 | 1565 |
| 48 (122) | 310 | 344 | 390 | 438 | 486 | 537 | 577 | 629 | 677 | 776 | 881 | 1069 | 1162 | 1259 | 1355 | 1551 | 1758 |
| 54 (137.2) | 320 | 367 | 420 | 471 | 525 | 574 | 627 | 683 | 730 | 841 | 956 | 1154 | 1257 | 1368 | 1468 | 1683 | 1910 |
| 60 (152.4) | 341 | 388 | 448 | 509 | 564 | 621 | 677 | 730 | 794 | 911 | 1034 | 1241 | 1353 | 1468 | 1581 | 1818 | 2069 |
| 66 (167.7) | 355 | 417 | 475 | 537 | 603 | 665 | 725 | 784 | 851 | 972 | 1111 | 1325 | 1454 | 1572 | 1698 | 1952 | 2222 |
| 72 (182.9) | 378 | 437 | 509 | 572 | 640 | 708 | 772 | 839 | 910 | 1044 | 1188 | 1414 | 1542 | 1678 | 1814 | 2083 | 2377 |
| 78 (198.2) | 391 | 460 | 528 | 604 | 679 | 751 | 822 | 894 | 965 | 1111 | 1270 | 1512 | 1636 | 1784 | 1927 | 2220 | 2536 |
| 84 (213.4) | 409 | 480 | 556 | 629 | 717 | 798 | 870 | 947 | 1021 | 1171 | 1342 | 1593 | 1740 | 1898 | 2045 | 2345 | 2688 |
| 90 (228.6) | 426 | 509 | 580 | 666 | 756 | 839 | 918 | 999 | 1083 | 1241 | 1425 | 1678 | 1837 | 1999 | 2158 | 2476 | 2844 |
| 96 (243.9) | 446 | 527 | 610 | 701 | 795 | 883 | 967 | 1051 | 1139 | 1306 | 1502 | 1771 | 1930 | 2102 | 2276 | 2619 | 3001 |
| 108 (274.4) | 464 | 556 | 650 | 738 | 841 | 934 | 1025 | 1118 | 1211 | 1393 | 1600 | 1873 | 2059 | 2237 | 2421 | 2782 | 3195 |
| 120 (304.8) | 509 | 604 | 708 | 805 | 914 | 1020 | 1118 | 1217 | 1323 | 1524 | 1744 | 2040 | 2241 | 2441 | 2641 | 3049 | 3495 |
| 132 (335.3) | 539 | 651 | 763 | 869 | 993 | 1107 | 1214 | 1324 | 1435 | 1647 | 1898 | 2209 | 2430 | 2643 | 2867 | 3304 | 3792 |
| 144 (365.8) | 577 | 704 | 821 | 934 | 1067 | 1188 | 1306 | 1426 | 1546 | 1784 | 2051 | 2377 | 2621 | 2849 | 3092 | 3571 | 4096 |

NOTE: Cordless lift maximum height is 86" (218.5 cm). Cordless lift continuous shades available in outlined area above.

NOTE: Continuous width fabric up to 144" (365.8 cm).

| Discovery ¾" Single Cell* | | | | | |
|---------------------------|------|------------|------|--------------|------|
| Barnwood | 0190 | Gingerroot | 0192 | Pier | 0194 |
| Elegant Dove | 0191 | Llama | 0193 | White Radish | 0195 |

*Color coordinated with Endeavor (light filtering)

| Scroll FR ¾" Single Cell | | | | | |
|--------------------------|------|--------------|------|-------|------|
| Adirondack | 2916 | Simply White | 2901 | Trevi | 2918 |
| Manila | 2914 | Spring Fawn | 2915 | | |

Price Group F: Enchantment Blackout 3/4" (2.0 cm) Single Cell, Infuse Light Filtering 3/4" (2.0 cm) Single Cell, Montage Blackout 3/4" (2.0 cm) Single Cell, Prestige Blackout 3/4" (2.0 cm) Single Cell, Sanctuary 3/4" (2.0 cm) Single Cell, Sanctuary 1/2" (1.3 cm) Double Cell, Splendor 1 1/4" (3.2 cm) Single Cell

| Height up to inches (cm) ↓ | Width up to inches (cm) → | | | | | | | | | | | | | | | | |
|----------------------------|---------------------------|-----------|-----------|------------|----------|------------|------------|------------|------------|------------|------------|-------------|-------------|-------------|-------------|-----------|-------------|
| | 24 (61) | 30 (76.2) | 36 (91.5) | 42 (106.7) | 48 (122) | 54 (137.2) | 60 (152.4) | 66 (167.7) | 72 (182.9) | 84 (213.4) | 96 (243.9) | 108 (274.4) | 120 (304.8) | 132 (335.3) | 144 (365.8) | 174 (442) | 192 (487.7) |
| 36 (91.5) | 312 | 350 | 396 | 442 | 489 | 531 | 573 | 620 | 665 | 754 | 976 | 1061 | 1146 | 1238 | 1327 | 1510 | 1951 |
| 42 (106.7) | 336 | 373 | 430 | 482 | 531 | 580 | 630 | 682 | 732 | 834 | 1061 | 1159 | 1266 | 1366 | 1466 | 1670 | 2125 |
| 48 (122) | 355 | 404 | 460 | 519 | 573 | 630 | 684 | 747 | 801 | 914 | 1146 | 1262 | 1371 | 1487 | 1597 | 1826 | 2290 |
| 54 (137.2) | 380 | 434 | 495 | 556 | 620 | 678 | 743 | 807 | 866 | 990 | 1238 | 1357 | 1478 | 1613 | 1732 | 1980 | 2480 |
| 60 (152.4) | 399 | 458 | 528 | 594 | 662 | 729 | 801 | 866 | 935 | 1071 | 1324 | 1463 | 1596 | 1732 | 1864 | 2147 | 2645 |
| 66 (167.7) | 425 | 489 | 562 | 630 | 711 | 783 | 858 | 925 | 1004 | 1150 | 1415 | 1560 | 1713 | 1855 | 2001 | 2296 | 2835 |
| 72 (182.9) | 442 | 514 | 594 | 673 | 754 | 834 | 913 | 988 | 1069 | 1228 | 1508 | 1669 | 1821 | 1977 | 2139 | 2459 | 3017 |
| 78 (198.2) | 461 | 539 | 624 | 711 | 802 | 886 | 967 | 1052 | 1139 | 1308 | 1598 | 1776 | 1933 | 2099 | 2277 | 2616 | 3197 |
| 84 (213.4) | 482 | 569 | 657 | 747 | 842 | 938 | 1030 | 1116 | 1205 | 1381 | 1690 | 1876 | 2054 | 2234 | 2408 | 2760 | 3379 |
| 90 (228.6) | 502 | 594 | 687 | 785 | 893 | 988 | 1083 | 1178 | 1273 | 1459 | 1784 | 1977 | 2167 | 2351 | 2530 | 2920 | 3566 |
| 96 (243.9) | 526 | 621 | 722 | 824 | 936 | 1043 | 1139 | 1238 | 1342 | 1541 | 1872 | 2083 | 2282 | 2480 | 2683 | 3080 | 3745 |
| 108 (274.4) | 534 | 642 | 748 | 849 | 967 | 1072 | 1178 | 1285 | 1395 | 1600 | 1908 | 2153 | 2368 | 2573 | 2784 | 3200 | 3771 |
| 120 (304.8) | 550 | 654 | 761 | 869 | 988 | 1107 | 1208 | 1316 | 1426 | 1643 | 1930 | 2209 | 2420 | 2633 | 2866 | 3287 | 3867 |
| 132 (335.3) | 576 | 692 | 807 | 922 | 1050 | 1180 | 1285 | 1400 | 1516 | 1749 | 2053 | 2348 | 2573 | 2800 | 3060 | 3496 | 4107 |
| 144 (365.8) | 608 | 730 | 851 | 973 | 1110 | 1250 | 1362 | 1484 | 1606 | 1858 | 2172 | 2486 | 2726 | 2968 | 3250 | 3715 | 4347 |

NOTE: Cordless lift maximum height is 86" (218.5 cm). Cordless lift continuous shades available in outlined area above.

NOTE: Continuous width fabric up to 144" (365.8 cm).

NOTE: 1 1/4" (3.2 cm) single cell fabrics are only available in cordless lift, bottom up/top down cordless lift, and motorized lift.

| Enchantment Blackout 3/4" Single Cell* | | | | | |
|--|------|-------------|------|---------------|------|
| Genteel Beige | 0625 | Regal Gray | 0627 | Silver Shadow | 0629 |
| Glacial Gray | 0626 | Ridged Sand | 0628 | | |

*Color coordinated with Enchantment Light Filtering

| Infuse Light Filtering 3/4" Single Cell* | | | | | |
|--|------|-----------------|------|------------------|------|
| Aspen | 0950 | Indigo Intrigue | 0954 | Taupe Perfection | 0958 |
| Autumn Gold | 0951 | Rivermist | 0955 | Vanilla Cream | 0959 |
| Balanced Beige | 0952 | Savvy Slate | 0956 | | |
| Ecru | 0953 | Subtle Sage | 0957 | | |

*Color coordinated with Infuse Blackout

| Montage Blackout 3/4" Single Cell* | | | | | |
|------------------------------------|------|--------------|------|-----------|------|
| Chroma Gray | 0615 | Gray Granite | 0617 | Gray Moon | 0619 |
| Cultivated Khaki | 0616 | Gray Hues | 0618 | | |

*Color coordinated with Montage Light Filtering

| Prestige Blackout 3/4" Single Cell* | | | | | |
|-------------------------------------|------|--------------|------|---------------------|------|
| Beige Influence | 0595 | Pale Pebble | 0597 | Sophisticated Stone | 0599 |
| Gray Juniper | 0596 | Refined Flax | 0598 | | |

*Color coordinated with Prestige Light Filtering

| Sanctuary 1/2" Double Cell* | | | | | |
|-----------------------------|------|-----------------|------|-----------------|------|
| Arctic White | 1451 | Gray Mystique | 1469 | Sandpiper | 1477 |
| Blue Breeze | 1464 | Harvested Wheat | 1449 | Sculpture Gray | 1471 |
| Caribou | 1454 | Hushed Gray | 1479 | Seascape | 1467 |
| Champagne | 1453 | Irish Coffee | 1444 | Shell White | 1461 |
| Cool Amethyst | 1473 | Light Azure | 1463 | Shoreline Sand | 1450 |
| Cornerstone | 1478 | Liquid Silver | 1440 | Smoky Quartz | 1468 |
| Dark Taupe | 1472 | Midnight Sky | 1448 | Sweetwater Sage | 1460 |
| Eggnog | 1446 | Navy Charm | 1466 | Timberwolf Gray | 1445 |
| Elusive Gray | 1474 | Nostalgic Beige | 1459 | Tuscan Red | 1458 |
| Freshwater Pearl | 1442 | Pink Rose | 1465 | Umber | 1476 |
| Gentle Beige | 1457 | Powder Gray | 1452 | Villa | 1443 |
| Gentle Tan | 1447 | Rich Burgundy | 1462 | Whisper White | 1441 |
| Golden Wheat | 1470 | River Delta | 1456 | | |
| Gray Fedora | 1455 | River Stone | 1475 | | |

*Color coordinated with Splendor (light filtering)

| Sanctuary 3/4" Single Cell* | | | | | |
|------------------------------------|------|-----------------|------|-----------------|------|
| Arctic White | 1251 | Gray Mystique | 1269 | Sandpiper | 1277 |
| Blue Breeze | 1264 | Harvested Wheat | 1249 | Sculpture Gray | 1271 |
| Caribou | 1254 | Hushed Gray | 1279 | Seascape | 1267 |
| Champagne | 1253 | Irish Coffee | 1244 | Shell White | 1261 |
| Cool Amethyst | 1273 | Light Azure | 1263 | Shoreline Sand | 1250 |
| Cornerstone | 1278 | Liquid Silver | 1240 | Smoky Quartz | 1268 |
| Dark Taupe | 1272 | Midnight Sky | 1248 | Sweetwater Sage | 1260 |
| Eggnog | 1246 | Navy Charm | 1266 | Timberwolf Gray | 1245 |
| Elusive Gray | 1274 | Nostalgic Beige | 1259 | Tuscan Red | 1258 |
| Freshwater Pearl | 1242 | Pink Rose | 1265 | Umber | 1276 |
| Gentle Beige | 1257 | Powder Gray | 1252 | Villa | 1243 |
| Gentle Tan | 1247 | Rich Burgundy | 1262 | Whisper White | 1241 |
| Golden Wheat | 1270 | River Delta | 1256 | | |
| Gray Fedora | 1255 | River Stone | 1275 | | |

*Color coordinated with Splendor (light filtering)

| Splendor 1 1/4" Single Cell** | | | | | |
|--------------------------------------|------|---------------|------|---------------|------|
| Cornerstone | 0124 | Liquid Silver | 0120 | Shell White | 0122 |
| Hushed Gray | 0125 | Sandpiper | 0123 | Whisper White | 0121 |

**Color coordinated with Sanctuary (blackout)

Price Group G: Couture Light Filtering 3/4" (2.0 cm) Single Cell, Simply Sheer 3/4" (2.0 cm) Single Cell, Valletta 3/4" (2.0 cm) Single Cell

| Height up to inches (cm) ↓ | Width up to inches (cm) → | | | | | | | | | | | | | | | | |
|-------------------------------|---------------------------|--------------|--------------|---------------|-------------|---------------|---------------|---------------|---------------|---------------|---------------|----------------|----------------|----------------|----------------|--------------|----------------|
| | 24 (61) | 30 (76.2) | 36 (91.5) | 42 (106.7) | 48 (122) | 54 (137.2) | 60 (152.4) | 66 (167.7) | 72 (182.9) | 84 (213.4) | 96 (243.9) | 108 (274.4) | 120 (304.8) | 132 (335.3) | 144 (365.8) | 174 (442) | 192 (487.7) |
| 36 (91.5) | 322 | 362 | 409 | 459 | 506 | 550 | 593 | 643 | 690 | 784 | 1010 | 1098 | 1186 | 1283 | 1376 | 1563 | 2023 |
| 42 (106.7) | 347 | 386 | 447 | 498 | 550 | 600 | 651 | 706 | 756 | 864 | 1098 | 1199 | 1309 | 1412 | 1518 | 1730 | 2199 |
| 48 (122) | 368 | 420 | 478 | 538 | 593 | 651 | 709 | 772 | 827 | 945 | 1186 | 1306 | 1418 | 1540 | 1655 | 1892 | 2372 |
| 54 (137.2) | 393 | 449 | 513 | 576 | 643 | 704 | 770 | 833 | 895 | 1026 | 1283 | 1404 | 1531 | 1669 | 1796 | 2051 | 2567 |
| 60 (152.4) | 412 | 476 | 548 | 614 | 683 | 754 | 827 | 895 | 968 | 1109 | 1373 | 1514 | 1653 | 1796 | 1931 | 2224 | 2740 |
| 66 (167.7) | 437 | 506 | 580 | 651 | 733 | 808 | 886 | 958 | 1037 | 1188 | 1465 | 1615 | 1775 | 1921 | 2072 | 2381 | 2935 |
| 72 (182.9) | 459 | 531 | 614 | 697 | 784 | 864 | 944 | 1025 | 1108 | 1270 | 1561 | 1728 | 1886 | 2046 | 2215 | 2546 | 3124 |
| 78 (198.2) | 479 | 560 | 646 | 733 | 828 | 918 | 1003 | 1091 | 1180 | 1355 | 1657 | 1837 | 2004 | 2174 | 2356 | 2711 | 3308 |
| 84 (213.4) | 498 | 587 | 679 | 772 | 872 | 970 | 1066 | 1155 | 1246 | 1431 | 1750 | 1946 | 2126 | 2313 | 2494 | 2860 | 3496 |
| 90 (228.6) | 520 | 614 | 712 | 811 | 924 | 1025 | 1121 | 1220 | 1319 | 1512 | 1848 | 2046 | 2242 | 2433 | 2621 | 3023 | 3693 |
| 96 (243.9) | 545 | 644 | 747 | 853 | 969 | 1081 | 1180 | 1283 | 1388 | 1595 | 1936 | 2157 | 2360 | 2567 | 2778 | 3189 | 3875 |
| 108 (274.4) | 569 | 672 | 783 | 892 | 1014 | 1139 | 1241 | 1348 | 1458 | 1682 | 2026 | 2265 | 2478 | 2696 | 2935 | 3357 | 4059 |
| 120 (304.8) | 592 | 703 | 812 | 935 | 1062 | 1195 | 1300 | 1411 | 1526 | 1766 | 2115 | 2375 | 2597 | 2825 | 3094 | 3524 | 4237 |
| 132 (335.3) | 614 | 729 | 850 | 973 | 1107 | 1254 | 1356 | 1475 | 1595 | 1851 | 2206 | 2486 | 2716 | 2957 | 3250 | 3691 | 4420 |
| 144 (365.8) | 640 | 756 | 883 | 1014 | 1152 | 1310 | 1416 | 1540 | 1664 | 1932 | 2293 | 2596 | 2834 | 3086 | 3407 | 3858 | 4597 |

NOTE: Cordless lift maximum height is 86" (218.5 cm). Cordless lift continuous shades available in outlined area above.

NOTE: Continuous width fabric up to 144" (365.8 cm).

| Couture Light Filtering 3/4" Single Cell | | | | | |
|---|------|--------------|------|---------------|------|
| Feather White | 0130 | Noble Pewter | 0133 | Peaceful Gray | 0135 |
| Heron Plume | 0131 | Jute | 0134 | | |

*Color coordinated with Couture Blackout

| Simply Sheer 3/4" Single Cell | | | | | |
|--------------------------------------|------|-------|------|---------|------|
| Almond | 2152 | Mocha | 2154 | Whisper | 2150 |

| Valletta 3/4" Single Cell | | | | | |
|----------------------------------|------|---------------|------|--------------|------|
| Adirondack | 2855 | Coconut Cream | 2851 | Trevi | 2857 |
| Atlantic Frost | 2858 | Manila | 2852 | Walnut Shell | 2856 |
| Cinnamon Spice | 0642 | Simply White | 2850 | | |
| Crisp Carbon | 0643 | Spring Fawn | 2854 | | |

Price Group H: Infuse Blackout ¾" (2.0 cm) Single Cell, Kinsley Light Filtering ¾" (2.0 cm) Single Cell, Sanctuary 1¼" (3.2 cm) Single Cell, Valletta 1¼" (3.2 cm) Single Cell

| Height up to inches (cm) ↓ | Width up to inches (cm) → | | | | | | | | | | | | | | | | |
|-------------------------------|---------------------------|--------------|--------------|---------------|-------------|---------------|---------------|---------------|---------------|---------------|---------------|----------------|----------------|----------------|----------------|--------------|----------------|
| | 24 (61) | 30 (76.2) | 36 (91.5) | 42 (106.7) | 48 (122) | 54 (137.2) | 60 (152.4) | 66 (167.7) | 72 (182.9) | 84 (213.4) | 96 (243.9) | 108 (274.4) | 120 (304.8) | 132 (335.3) | 144 (365.8) | 174 (442) | 192 (487.7) |
| 36 (91.5) | 375 | 422 | 477 | 536 | 586 | 640 | 692 | 747 | 801 | 910 | 1176 | 1278 | 1379 | 1491 | 1600 | 1818 | 2352 |
| 42 (106.7) | 406 | 452 | 516 | 579 | 640 | 698 | 758 | 823 | 884 | 1007 | 1278 | 1396 | 1524 | 1643 | 1764 | 2010 | 2558 |
| 48 (122) | 428 | 486 | 554 | 626 | 692 | 758 | 825 | 899 | 962 | 1101 | 1379 | 1518 | 1650 | 1793 | 1924 | 2201 | 2757 |
| 54 (137.2) | 459 | 520 | 595 | 672 | 747 | 815 | 893 | 970 | 1044 | 1195 | 1491 | 1636 | 1782 | 1942 | 2088 | 2386 | 2985 |
| 60 (152.4) | 479 | 551 | 636 | 716 | 797 | 880 | 962 | 1044 | 1124 | 1291 | 1595 | 1760 | 1922 | 2088 | 2246 | 2584 | 3183 |
| 66 (167.7) | 511 | 586 | 676 | 758 | 853 | 941 | 1032 | 1116 | 1206 | 1382 | 1705 | 1879 | 2064 | 2236 | 2412 | 2768 | 3415 |
| 72 (182.9) | 536 | 621 | 716 | 810 | 910 | 1007 | 1100 | 1193 | 1290 | 1478 | 1815 | 2008 | 2190 | 2381 | 2578 | 2961 | 3637 |
| 78 (198.2) | 555 | 651 | 749 | 853 | 963 | 1066 | 1164 | 1269 | 1373 | 1579 | 1925 | 2137 | 2331 | 2529 | 2741 | 3153 | 3852 |
| 84 (213.4) | 579 | 682 | 792 | 899 | 1014 | 1128 | 1238 | 1344 | 1452 | 1667 | 2037 | 2262 | 2474 | 2689 | 2900 | 3326 | 4068 |
| 90 (228.6) | 606 | 716 | 829 | 944 | 1077 | 1193 | 1302 | 1421 | 1535 | 1759 | 2151 | 2381 | 2608 | 2833 | 3051 | 3517 | 4298 |
| 96 (243.9) | 632 | 748 | 868 | 992 | 1125 | 1259 | 1373 | 1491 | 1616 | 1855 | 2256 | 2506 | 2748 | 2985 | 3232 | 3710 | 4508 |
| 108 (274.4) | 658 | 784 | 908 | 1039 | 1179 | 1324 | 1440 | 1567 | 1694 | 1954 | 2359 | 2638 | 2885 | 3136 | 3415 | 3906 | 4717 |
| 120 (304.8) | 691 | 814 | 945 | 1086 | 1231 | 1389 | 1513 | 1640 | 1777 | 2054 | 2461 | 2761 | 3019 | 3287 | 3598 | 4101 | 4929 |
| 132 (335.3) | 716 | 849 | 987 | 1134 | 1285 | 1459 | 1580 | 1717 | 1855 | 2152 | 2568 | 2894 | 3160 | 3438 | 3782 | 4294 | 5141 |
| 144 (365.8) | 745 | 884 | 1026 | 1179 | 1341 | 1525 | 1647 | 1793 | 1936 | 2253 | 2669 | 3017 | 3295 | 3589 | 3963 | 4493 | 5349 |

NOTE: Cordless lift maximum height is 86" (218.5 cm). Cordless lift continuous shades available in outlined area above.

NOTE: Continuous width fabric up to 144" (365.8 cm).

| Infuse Blackout ¾" Single Cell* | | | | | |
|---------------------------------|------|-----------------|------|------------------|------|
| Aspen | 3950 | Indigo Intrigue | 3954 | Taupe Perfection | 3958 |
| Autumn Gold | 3951 | Rivermist | 3955 | Vanilla Cream | 3959 |
| Balanced Beige | 3952 | Savvy Slate | 3956 | | |
| Ecru | 3953 | Subtle Sage | 3957 | | |

*Color coordinated with Infuse Light Filtering

| Kinsley Light Filtering ¾" Single Cell | | | | | |
|--|------|-----------------|------|------------------|------|
| Aspen | 0720 | Indigo Intrigue | 0727 | Taupe Perfection | 0728 |
| Autumn Gold | 0722 | Rivermist | 0729 | Vanilla Cream | 0724 |
| Balanced Beige | 0723 | Savvy Slate | 0725 | | |
| Ecru | 0721 | Subtle Sage | 0726 | | |

*Color coordinated with Kinsley Blackout

| Sanctuary 1 ¼" Single Cell* | | | | | |
|-----------------------------|------|-------------|------|---------------|------|
| Hushed Gray | 0113 | Shell White | 0111 | Whisper White | 0110 |
| Sandpiper | 0112 | | | | |

*Color coordinated with Splendor (light filtering)

| Valletta 1 ¼" Single Cell | | | | | |
|---------------------------|------|--------------|------|-------|------|
| Coconut Cream | 0662 | Simply White | 0660 | Trevi | 0661 |
| Manila | 0663 | | | | |

Price Group I: Couture Blackout ¾" (2.0 cm) Single Cell, Kinsley Blackout ¾" (2.0 cm)

Single Cell

| Height up to inches (cm) ↓ | Width up to inches (cm) → | | | | | | | | | | | | | | | | |
|-------------------------------|---------------------------|--------------|--------------|---------------|-------------|---------------|---------------|---------------|---------------|---------------|---------------|----------------|----------------|----------------|----------------|--------------|----------------|
| | 24 (61) | 30 (76.2) | 36 (91.5) | 42 (106.7) | 48 (122) | 54 (137.2) | 60 (152.4) | 66 (167.7) | 72 (182.9) | 84 (213.4) | 96 (243.9) | 108 (274.4) | 120 (304.8) | 132 (335.3) | 144 (365.8) | 174 (442) | 192 (487.7) |
| 36 (91.5) | 470 | 528 | 598 | 670 | 734 | 802 | 865 | 935 | 1003 | 1139 | 1472 | 1598 | 1726 | 1867 | 2003 | 2276 | 2945 |
| 42 (106.7) | 508 | 566 | 647 | 725 | 802 | 876 | 951 | 1029 | 1107 | 1260 | 1598 | 1746 | 1909 | 2059 | 2208 | 2517 | 3203 |
| 48 (122) | 537 | 608 | 695 | 783 | 865 | 951 | 1032 | 1124 | 1204 | 1379 | 1726 | 1900 | 2063 | 2243 | 2408 | 2754 | 3451 |
| 54 (137.2) | 574 | 651 | 746 | 841 | 935 | 1023 | 1119 | 1215 | 1308 | 1493 | 1867 | 2047 | 2231 | 2430 | 2612 | 2987 | 3738 |
| 60 (152.4) | 601 | 691 | 798 | 895 | 998 | 1099 | 1204 | 1308 | 1408 | 1616 | 1998 | 2204 | 2407 | 2612 | 2813 | 3235 | 3987 |
| 66 (167.7) | 639 | 734 | 847 | 951 | 1068 | 1178 | 1292 | 1397 | 1510 | 1732 | 2134 | 2352 | 2584 | 2800 | 3020 | 3466 | 4276 |
| 72 (182.9) | 670 | 777 | 895 | 1014 | 1139 | 1260 | 1377 | 1492 | 1614 | 1851 | 2272 | 2516 | 2744 | 2979 | 3228 | 3708 | 4554 |
| 78 (198.2) | 697 | 814 | 938 | 1068 | 1205 | 1336 | 1457 | 1588 | 1717 | 1976 | 2409 | 2676 | 2918 | 3166 | 3432 | 3948 | 4824 |
| 84 (213.4) | 725 | 855 | 992 | 1124 | 1271 | 1413 | 1550 | 1683 | 1817 | 2087 | 2551 | 2832 | 3098 | 3366 | 3632 | 4164 | 5095 |
| 90 (228.6) | 758 | 895 | 1039 | 1182 | 1347 | 1492 | 1631 | 1778 | 1919 | 2203 | 2694 | 2979 | 3267 | 3546 | 3820 | 4405 | 5381 |
| 96 (243.9) | 794 | 936 | 1088 | 1243 | 1409 | 1577 | 1717 | 1867 | 2024 | 2322 | 2825 | 3140 | 3439 | 3738 | 4046 | 4646 | 5645 |
| 108 (274.4) | 826 | 980 | 1137 | 1300 | 1477 | 1658 | 1804 | 1962 | 2123 | 2447 | 2954 | 3302 | 3612 | 3926 | 4276 | 4891 | 5905 |
| 120 (304.8) | 863 | 1021 | 1184 | 1359 | 1542 | 1741 | 1894 | 2055 | 2225 | 2572 | 3080 | 3458 | 3781 | 4114 | 4505 | 5134 | 6170 |
| 132 (335.3) | 895 | 1063 | 1236 | 1420 | 1610 | 1826 | 1978 | 2151 | 2322 | 2696 | 3214 | 3622 | 3956 | 4305 | 4735 | 5377 | 6436 |
| 144 (365.8) | 931 | 1107 | 1284 | 1477 | 1678 | 1910 | 2062 | 2243 | 2425 | 2817 | 3343 | 3779 | 4126 | 4495 | 4961 | 5622 | 6698 |

NOTE: Cordless lift maximum height is 86" (218.5 cm). Cordless lift continuous shades available in outlined area above.

NOTE: Continuous width fabric up to 144" (365.8 cm).

| Couture Blackout ¾" Single Cell | | | | | |
|--|------|--------------|------|---------------|------|
| Feather White | 1130 | Jute | 1134 | Peaceful Gray | 1135 |
| Heron Plume | 1131 | Noble Pewter | 1133 | | |

*Color coordinated with Couture Light Filtering

| Kinsley Blackout ¾" Single Cell | | | | | |
|--|------|-----------------|------|------------------|------|
| Aspen | 1720 | Indigo Intrigue | 1727 | Taupe Perfection | 1728 |
| Autumn Gold | 1722 | Rivermist | 1729 | Vanilla Cream | 1724 |
| Balanced Beige | 1723 | Savvy Slate | 1725 | | |
| Ecru | 1721 | Subtle Sage | 1726 | | |

*Color coordinated with Kinsley Light Filtering

Price Group J: Endeavor 3/4" (2.0 cm) Single Cell

Grabber Slide-Vue

| Height up to inches (cm) ↓ | Width up to inches (cm) → | | | | | | | | | | | | | | | | | | |
|-------------------------------|---------------------------|--------------|--------------|---------------|-------------|---------------|---------------|---------------|---------------|---------------|---------------|---------------|----------------|----------------|----------------|----------------|----------------|--------------|----------------|
| | 24 (61) | 30 (76.2) | 36 (91.5) | 42 (106.7) | 48 (122) | 54 (137.2) | 60 (152.4) | 66 (167.7) | 72 (182.9) | 78 (198.2) | 84 (213.4) | 96 (243.9) | 108 (274.4) | 120 (304.8) | 132 (335.3) | 144 (365.8) | 156 (396.3) | 174 (442) | 192 (487.7) |
| 36 (91.5) | 723 | 794 | 864 | 931 | 988 | 1041 | 1110 | 1172 | 1227 | 1316 | 1346 | 1457 | 1655 | 1728 | 1818 | 1889 | 2013 | 2028 | 2156 |
| 42 (106.7) | 738 | 811 | 886 | 956 | 1012 | 1077 | 1144 | 1211 | 1269 | 1360 | 1395 | 1497 | 1714 | 1802 | 1896 | 1972 | 2110 | 2121 | 2244 |
| 48 (122) | 749 | 828 | 904 | 979 | 1041 | 1108 | 1177 | 1248 | 1310 | 1412 | 1444 | 1571 | 1777 | 1869 | 1970 | 2056 | 2211 | 2224 | 2388 |
| 54 (137.2) | 763 | 842 | 931 | 1004 | 1067 | 1136 | 1210 | 1283 | 1353 | 1458 | 1488 | 1623 | 1837 | 1935 | 2046 | 2137 | 2305 | 2313 | 2500 |
| 60 (152.4) | 775 | 863 | 944 | 1024 | 1096 | 1164 | 1249 | 1323 | 1397 | 1511 | 1540 | 1686 | 1899 | 2008 | 2121 | 2217 | 2407 | 2413 | 2612 |
| 66 (167.7) | 794 | 883 | 970 | 1048 | 1122 | 1198 | 1281 | 1362 | 1436 | 1559 | 1590 | 1740 | 1960 | 2076 | 2198 | 2305 | 2502 | 2512 | 2727 |
| 72 (182.9) | 801 | 893 | 988 | 1077 | 1156 | 1229 | 1316 | 1400 | 1477 | 1611 | 1637 | 1796 | 2031 | 2147 | 2271 | 2388 | 2601 | 2609 | 2837 |
| 78 (198.2) | 814 | 913 | 1009 | 1096 | 1179 | 1263 | 1352 | 1444 | 1522 | 1657 | 1688 | 1853 | 2095 | 2215 | 2354 | 2478 | 2697 | 2705 | 2955 |
| 84 (213.4) | 827 | 925 | 1030 | 1116 | 1211 | 1299 | 1388 | 1478 | 1566 | 1702 | 1731 | 1909 | 2157 | 2291 | 2432 | 2556 | 2785 | 2796 | 3066 |
| 90 (228.6) | 840 | 943 | 1048 | 1138 | 1237 | 1326 | 1423 | 1517 | 1603 | 1751 | 1778 | 1970 | 2217 | 2360 | 2504 | 2644 | 2884 | 2892 | 3177 |
| 96 (243.9) | 856 | 963 | 1066 | 1164 | 1268 | 1357 | 1458 | 1557 | 1645 | 1801 | 1830 | 2024 | 2286 | 2433 | 2585 | 2727 | 2983 | 2992 | 3292 |
| 108 (274.4) | 874 | 987 | 1096 | 1200 | 1305 | 1401 | 1512 | 1611 | 1709 | 1872 | 1898 | 2102 | 2368 | 2530 | 2694 | 2845 | 3116 | 3128 | 3442 |
| 120 (304.8) | 908 | 1029 | 1146 | 1253 | 1368 | 1473 | 1586 | 1693 | 1799 | 1979 | 2008 | 2228 | 2502 | 2679 | 2861 | 3023 | 3329 | 3337 | 3685 |

| Endeavor 3/4" Single Cell | | | | | |
|---------------------------|------|--------------|------|-----------------|------|
| Atlantic Frost | 0370 | Elegant Dove | 0374 | Pier | 0378 |
| Barnwood | 0371 | Gingerroot | 0375 | Soft Coal | 0379 |
| Brown Squirrel | 0372 | Lime Chiffon | 0376 | Thickened Cream | 0380 |
| Canadian Tuxedo | 0373 | Llama | 0377 | White Radish | 0381 |

Price Group K: Splendor 3/4" (2.0 cm) Single Cell

Grabr Slide-Vue

| Height up to inches (cm) ↓ | Width up to inches (cm) → | | | | | | | | | | | | | | | | | | |
|-------------------------------|---------------------------|--------------|--------------|---------------|-------------|---------------|---------------|---------------|---------------|---------------|---------------|---------------|----------------|----------------|----------------|----------------|----------------|--------------|----------------|
| | 24 (61) | 30 (76.2) | 36 (91.5) | 42 (106.7) | 48 (122) | 54 (137.2) | 60 (152.4) | 66 (167.7) | 72 (182.9) | 78 (198.2) | 84 (213.4) | 96 (243.9) | 108 (274.4) | 120 (304.8) | 132 (335.3) | 144 (365.8) | 156 (396.3) | 174 (442) | 192 (487.7) |
| 36 (91.5) | 746 | 814 | 893 | 966 | 1026 | 1086 | 1158 | 1225 | 1289 | 1388 | 1413 | 1540 | 1762 | 1854 | 1953 | 2038 | 2193 | 2204 | 2370 |
| 42 (106.7) | 756 | 839 | 918 | 992 | 1061 | 1125 | 1201 | 1270 | 1342 | 1449 | 1478 | 1593 | 1842 | 1946 | 2052 | 2146 | 2318 | 2328 | 2477 |
| 48 (122) | 773 | 863 | 944 | 1022 | 1097 | 1169 | 1244 | 1321 | 1396 | 1510 | 1539 | 1680 | 1924 | 2027 | 2146 | 2247 | 2440 | 2451 | 2650 |
| 54 (137.2) | 796 | 882 | 971 | 1052 | 1126 | 1201 | 1284 | 1371 | 1444 | 1569 | 1595 | 1752 | 1998 | 2114 | 2241 | 2351 | 2560 | 2572 | 2793 |
| 60 (152.4) | 809 | 901 | 999 | 1083 | 1164 | 1245 | 1334 | 1414 | 1496 | 1633 | 1661 | 1826 | 2076 | 2204 | 2335 | 2460 | 2685 | 2696 | 2939 |
| 66 (167.7) | 826 | 924 | 1021 | 1110 | 1198 | 1282 | 1378 | 1467 | 1550 | 1691 | 1719 | 1896 | 2156 | 2293 | 2430 | 2568 | 2806 | 2816 | 3079 |
| 72 (182.9) | 843 | 947 | 1049 | 1145 | 1234 | 1322 | 1416 | 1511 | 1604 | 1758 | 1783 | 1969 | 2237 | 2378 | 2525 | 2667 | 2928 | 2939 | 3220 |
| 78 (198.2) | 861 | 966 | 1071 | 1173 | 1270 | 1362 | 1464 | 1564 | 1656 | 1818 | 1845 | 2038 | 2326 | 2465 | 2628 | 2776 | 3056 | 3065 | 3365 |
| 84 (213.4) | 874 | 985 | 1098 | 1197 | 1305 | 1406 | 1510 | 1614 | 1710 | 1874 | 1902 | 2109 | 2403 | 2560 | 2730 | 2883 | 3163 | 3177 | 3505 |
| 90 (228.6) | 892 | 1008 | 1122 | 1230 | 1344 | 1444 | 1555 | 1660 | 1761 | 1933 | 1967 | 2183 | 2478 | 2649 | 2823 | 2983 | 3291 | 3297 | 3650 |
| 96 (243.9) | 906 | 1029 | 1150 | 1262 | 1377 | 1485 | 1595 | 1710 | 1815 | 1998 | 2025 | 2254 | 2565 | 2738 | 2920 | 3091 | 3415 | 3424 | 3792 |
| 108 (274.4) | 925 | 1054 | 1179 | 1300 | 1416 | 1532 | 1655 | 1768 | 1881 | 2075 | 2101 | 2340 | 2657 | 2846 | 3039 | 3227 | 3566 | 3582 | 3968 |
| 120 (304.8) | 962 | 1099 | 1234 | 1356 | 1485 | 1612 | 1738 | 1858 | 1983 | 2194 | 2225 | 2478 | 2808 | 3014 | 3231 | 3424 | 3811 | 3821 | 4245 |

Splendor 3/4" Single Cell*

| | | | | | |
|-------------------|------|-----------------|------|-----------------|------|
| Aqua Glow | 1369 | Harvested Wheat | 1331 | Shoreline Sand | 1332 |
| Arctic White | 1333 | Hushed Gray | 1373 | Smoky Quartz | 1353 |
| Blue Breeze | 1349 | Irish Coffee | 1324 | Sweetwater Sage | 1344 |
| Caribou | 1337 | Light Azure | 1348 | Timberwolf Gray | 1325 |
| Champagne | 1336 | Liquid Silver | 1320 | Tonal Taupe | 1363 |
| Chocolate Cupcake | 1365 | London Skies | 1361 | Tuscan Red | 1342 |
| Coastal Nuance | 1357 | Midnight Sky | 1330 | Umber | 1370 |
| Cool Amethyst | 1362 | Natural Beige | 1326 | Villa | 1323 |
| Cornerstone | 1372 | Navy Charm | 1351 | Whisper White | 1321 |
| Dark Taupe | 1360 | Nostalgic Beige | 1343 | | |
| Eggnog | 1328 | Peacock Plume | 1364 | | |
| Elusive Gray | 1367 | Pink Rose | 1350 | | |
| Endless Summer | 1356 | Powder Gray | 1334 | | |
| Freshwater Pearl | 1322 | Quiet Gray | 1327 | | |
| Gentle Beige | 1340 | Rich Burgundy | 1347 | | |
| Gentle Tan | 1329 | River Delta | 1339 | | |
| Golden Wheat | 1355 | River Stone | 1368 | | |
| Gray Dusk | 1335 | Sandpiper | 1371 | | |
| Gray Fedora | 1338 | Sculpture Gray | 1359 | | |
| Gray Mystique | 1354 | Seascape | 1352 | | |
| Gray Violet | 1341 | Shell White | 1345 | | |

*Color coordinates with Sanctuary (blackout).

Price Group L: Splendor 1/2" (1.3 cm) Double Cell, Enchantment Light Filtering 3/4" (2.0 cm) Single Cell, Montage Light Filtering 3/4" (2.0 cm) Single Cell Prestige Light Filtering 3/4" (2.0 cm) Single Cell

Grabr Slide-Vue

| Height up to inches (cm) ↓ | Width up to inches (cm) → | | | | | | | | | | | | | | | | | | |
|-------------------------------|---------------------------|--------------|--------------|---------------|-------------|---------------|---------------|---------------|---------------|---------------|---------------|---------------|----------------|----------------|----------------|----------------|----------------|--------------|----------------|
| | 24 (61) | 30 (76.2) | 36 (91.5) | 42 (106.7) | 48 (122) | 54 (137.2) | 60 (152.4) | 66 (167.7) | 72 (182.9) | 78 (198.2) | 84 (213.4) | 96 (243.9) | 108 (274.4) | 120 (304.8) | 132 (335.3) | 144 (365.8) | 156 (396.3) | 174 (442) | 192 (487.7) |
| 36 (91.5) | 766 | 840 | 921 | 999 | 1066 | 1126 | 1204 | 1276 | 1341 | 1451 | 1475 | 1610 | 1855 | 1952 | 2053 | 2152 | 2321 | 2333 | 2517 |
| 42 (106.7) | 785 | 868 | 953 | 1034 | 1098 | 1171 | 1254 | 1328 | 1401 | 1516 | 1545 | 1664 | 1942 | 2053 | 2163 | 2266 | 2461 | 2470 | 2634 |
| 48 (122) | 801 | 893 | 981 | 1064 | 1140 | 1217 | 1298 | 1381 | 1458 | 1583 | 1612 | 1768 | 2031 | 2146 | 2270 | 2388 | 2601 | 2608 | 2835 |
| 54 (137.2) | 824 | 915 | 1009 | 1098 | 1179 | 1259 | 1344 | 1437 | 1514 | 1654 | 1680 | 1852 | 2114 | 2241 | 2384 | 2498 | 2734 | 2745 | 2987 |
| 60 (152.4) | 837 | 935 | 1037 | 1128 | 1217 | 1302 | 1396 | 1484 | 1575 | 1725 | 1750 | 1929 | 2204 | 2345 | 2485 | 2620 | 2874 | 2884 | 3153 |
| 66 (167.7) | 858 | 966 | 1068 | 1165 | 1257 | 1345 | 1452 | 1545 | 1638 | 1789 | 1818 | 2005 | 2291 | 2445 | 2596 | 2739 | 3008 | 3018 | 3308 |
| 72 (182.9) | 882 | 986 | 1097 | 1205 | 1297 | 1394 | 1492 | 1593 | 1694 | 1860 | 1887 | 2088 | 2384 | 2534 | 2700 | 2856 | 3147 | 3156 | 3469 |
| 78 (198.2) | 898 | 1008 | 1123 | 1230 | 1341 | 1438 | 1545 | 1653 | 1750 | 1929 | 1955 | 2167 | 2476 | 2633 | 2809 | 2975 | 3285 | 3295 | 3633 |
| 84 (213.4) | 915 | 1031 | 1149 | 1259 | 1375 | 1483 | 1596 | 1708 | 1813 | 1995 | 2024 | 2244 | 2562 | 2742 | 2930 | 3094 | 3413 | 3421 | 3786 |
| 90 (228.6) | 929 | 1058 | 1179 | 1294 | 1420 | 1524 | 1645 | 1760 | 1873 | 2060 | 2088 | 2325 | 2649 | 2842 | 3026 | 3208 | 3545 | 3554 | 3950 |
| 96 (243.9) | 948 | 1083 | 1206 | 1331 | 1457 | 1571 | 1697 | 1813 | 1929 | 2131 | 2162 | 2407 | 2742 | 2937 | 3136 | 3329 | 3689 | 3694 | 4111 |
| 108 (274.4) | 971 | 1110 | 1245 | 1373 | 1503 | 1630 | 1758 | 1881 | 2004 | 2217 | 2247 | 2501 | 2851 | 3062 | 3274 | 3477 | 3858 | 3869 | 4308 |
| 120 (304.8) | 1009 | 1158 | 1302 | 1438 | 1579 | 1715 | 1853 | 1984 | 2116 | 2352 | 2384 | 2659 | 3019 | 3248 | 3484 | 3703 | 4131 | 4142 | 4613 |

Splendor 1/2" Double Cell*

| | | | | | |
|--------------|------|---------------|------|---------------|------|
| Aqua Glow | 1569 | Gray Dusk | 1535 | Quiet Gray | 1527 |
| Arctic White | 1533 | Gray Fedora | 1538 | Rich Burgundy | 1547 |
| Blue Breeze | 1549 | Gray Mystique | 1554 | River Delta | 1539 |
| Caribou | 1537 | Gray Violet | 1541 | River Stone | 1568 |

| | | | | | |
|-------------------|------|-----------------|------|-----------------|------|
| Champagne | 1536 | Harvested Wheat | 1531 | Sandpiper | 1571 |
| Chocolate Cupcake | 1565 | Hushed Gray | 1573 | Sculpture Gray | 1559 |
| Coastal Nuance | 1557 | Irish Coffee | 1524 | Seascape | 1552 |
| Cool Amethyst | 1562 | Light Azure | 1548 | Shell White | 1545 |
| Cornerstone | 1572 | Liquid Silver | 1520 | Shoreline Sand | 1532 |
| Dark Taupe | 1560 | London Skies | 1561 | Smoky Quartz | 1553 |
| Eggnog | 1528 | Midnight Sky | 1530 | Sweetwater Sage | 1544 |
| Elusive Gray | 1567 | Natural Beige | 1526 | Timberwolf Gray | 1525 |
| Endless Summer | 1556 | Navy Charm | 1551 | Tonal Taupe | 1563 |
| Freshwater Pearl | 1522 | Nostalgic Beige | 1543 | Tuscan Red | 1542 |
| Gentle Beige | 1540 | Peacock Plume | 1564 | Umber | 1570 |
| Gentle Tan | 1529 | Pink Rose | 1550 | Villa | 1523 |
| Golden Wheat | 1555 | Powder Gray | 1534 | Whisper White | 1521 |

*Color coordinates with Sanctuary (blackout).

| Enchantment Light Filtering 3/4" Single Cell | | | | | |
|---|------|---------------|------|-------------|------|
| Genteel Beige | 0620 | Silver Shadow | 0622 | Ridged Sand | 0624 |
| Regal Gray | 0621 | Glacial Gray | 0623 | | |

*Color coordinated with Enchantment Blackout

| Montage Light Filtering 3/4" Single Cell | | | | | |
|---|------|-------------|------|-----------|------|
| Gray Granite | 0610 | Gray Moon | 0612 | Gray Hues | 0614 |
| Cultivated Khaki | 0611 | Chroma Gray | 0613 | | |

*Color coordinated with Montage Blackout

| Prestige Light Filtering 3/4" Single Cell | | | | | |
|--|------|--------------|------|--------------|------|
| Beige Influence | 0590 | Refined Flax | 0592 | Gray Juniper | 0594 |
| Sophisticated Stone | 0591 | Pale Pebble | 0593 | | |

*Color coordinated with Presitge Blackout

Price Group M: Discovery 3/4" (2.0 cm) Single Cell, Scroll FR 3/4" (2.0 cm) Single Cell

Graber Slide-Vue

| Height up to inches (cm) ↓ | Width up to inches (cm) → | | | | | | | | | | | | | | | | | | |
|-------------------------------|---------------------------|--------------|--------------|---------------|-------------|---------------|---------------|---------------|---------------|---------------|---------------|---------------|----------------|----------------|----------------|----------------|----------------|--------------|----------------|
| | 24 (61) | 30 (76.2) | 36 (91.5) | 42 (106.7) | 48 (122) | 54 (137.2) | 60 (152.4) | 66 (167.7) | 72 (182.9) | 78 (198.2) | 84 (213.4) | 96 (243.9) | 108 (274.4) | 120 (304.8) | 132 (335.3) | 144 (365.8) | 156 (396.3) | 174 (442) | 192 (487.7) |
| 36 (91.5) | 811 | 890 | 972 | 1054 | 1120 | 1184 | 1262 | 1337 | 1406 | 1517 | 1541 | 1682 | 1924 | 2023 | 2131 | 2224 | 2394 | 2404 | 2586 |
| 42 (106.7) | 827 | 914 | 1005 | 1085 | 1158 | 1229 | 1309 | 1386 | 1465 | 1581 | 1614 | 1738 | 2012 | 2124 | 2237 | 2341 | 2529 | 2541 | 2701 |
| 48 (122) | 844 | 942 | 1030 | 1114 | 1196 | 1274 | 1354 | 1440 | 1522 | 1645 | 1680 | 1834 | 2098 | 2211 | 2341 | 2454 | 2664 | 2676 | 2892 |
| 54 (137.2) | 867 | 962 | 1060 | 1150 | 1230 | 1309 | 1402 | 1493 | 1574 | 1713 | 1740 | 1912 | 2181 | 2307 | 2447 | 2567 | 2793 | 2806 | 3049 |
| 60 (152.4) | 883 | 982 | 1088 | 1181 | 1270 | 1355 | 1455 | 1542 | 1633 | 1782 | 1814 | 1993 | 2266 | 2404 | 2549 | 2683 | 2932 | 2939 | 3205 |
| 66 (167.7) | 901 | 1009 | 1113 | 1212 | 1306 | 1400 | 1502 | 1600 | 1690 | 1847 | 1876 | 2069 | 2351 | 2502 | 2652 | 2798 | 3062 | 3074 | 3359 |
| 72 (182.9) | 920 | 1033 | 1146 | 1248 | 1347 | 1441 | 1545 | 1647 | 1750 | 1916 | 1947 | 2147 | 2441 | 2596 | 2758 | 2911 | 3197 | 3205 | 3513 |
| 78 (198.2) | 938 | 1054 | 1170 | 1279 | 1386 | 1486 | 1596 | 1709 | 1808 | 1981 | 2014 | 2224 | 2538 | 2690 | 2867 | 3027 | 3332 | 3346 | 3674 |
| 84 (213.4) | 954 | 1073 | 1197 | 1305 | 1425 | 1535 | 1645 | 1760 | 1864 | 2046 | 2074 | 2296 | 2622 | 2793 | 2980 | 3145 | 3453 | 3466 | 3824 |
| 90 (228.6) | 971 | 1099 | 1226 | 1342 | 1467 | 1574 | 1693 | 1813 | 1922 | 2112 | 2144 | 2382 | 2702 | 2891 | 3078 | 3256 | 3588 | 3598 | 3983 |
| 96 (243.9) | 988 | 1121 | 1253 | 1377 | 1501 | 1620 | 1740 | 1864 | 1978 | 2181 | 2209 | 2458 | 2796 | 2985 | 3183 | 3373 | 3728 | 3738 | 4137 |
| 108 (274.4) | 1010 | 1151 | 1289 | 1416 | 1545 | 1673 | 1805 | 1928 | 2054 | 2264 | 2294 | 2552 | 2897 | 3105 | 3319 | 3519 | 3894 | 3903 | 4331 |
| 120 (304.8) | 1050 | 1198 | 1347 | 1480 | 1620 | 1758 | 1894 | 2029 | 2163 | 2396 | 2427 | 2702 | 3064 | 3292 | 3524 | 3738 | 4160 | 4169 | 4632 |

Discovery 3/4" Single Cell*

| | | | | | |
|--------------|------|------------|------|--------------|------|
| Barnwood | 0190 | Gingerroot | 0192 | Pier | 0194 |
| Elegant Dove | 0191 | Llama | 0193 | White Radish | 0195 |

*Color coordinates with Endeavor (light filtering).

Scroll FR 3/4" Single Cell*

| | | | | | |
|------------|------|--------------|------|-------|------|
| Adirondack | 2916 | Simply White | 2901 | Trevi | 2918 |
| Manila | 2914 | Spring Fawn | 2915 | | |

*Color coordinates with Endeavor (light filtering).

Price Group N: Enchantment Blackout 3/4" (2.0 cm) Single Cell, Infuse Light Filtering 3/4" (2.0 cm) Single Cell, Montage Blackout 3/4" (2.0 cm) Single Cell, Prestige Blackout 3/4" (2.0 cm) Single Cell, Sanctuary 3/4" (2.0 cm) Single Cell, Sanctuary 1/2" (1.3 cm) Double Cell, Splendor 1 1/4" (3.2 cm) Single Cell

Graber Slide-Vue

| Height up to inches (cm) ↓ | Width up to inches (cm) → | | | | | | | | | | | | | | | | | | |
|-------------------------------|---------------------------|--------------|--------------|---------------|-------------|---------------|---------------|---------------|---------------|---------------|---------------|---------------|----------------|----------------|----------------|----------------|----------------|--------------|----------------|
| | 24 (61) | 30 (76.2) | 36 (91.5) | 42 (106.7) | 48 (122) | 54 (137.2) | 60 (152.4) | 66 (167.7) | 72 (182.9) | 78 (198.2) | 84 (213.4) | 96 (243.9) | 108 (274.4) | 120 (304.8) | 132 (335.3) | 144 (365.8) | 156 (396.3) | 174 (442) | 192 (487.7) |
| 36 (91.5) | 814 | 895 | 979 | 1061 | 1125 | 1191 | 1269 | 1343 | 1414 | 1524 | 1550 | 1819 | 1968 | 2076 | 2201 | 2309 | 2510 | 2518 | 2993 |
| 42 (106.7) | 832 | 919 | 1009 | 1089 | 1163 | 1236 | 1320 | 1396 | 1473 | 1602 | 1630 | 1908 | 2072 | 2202 | 2333 | 2454 | 2678 | 2687 | 3176 |
| 48 (122) | 849 | 947 | 1036 | 1121 | 1201 | 1281 | 1362 | 1457 | 1538 | 1684 | 1710 | 1998 | 2181 | 2313 | 2462 | 2589 | 2842 | 2854 | 3350 |
| 54 (137.2) | 870 | 967 | 1065 | 1156 | 1237 | 1324 | 1422 | 1522 | 1610 | 1764 | 1789 | 2095 | 2281 | 2426 | 2591 | 2730 | 3007 | 3014 | 3547 |
| 60 (152.4) | 887 | 988 | 1096 | 1188 | 1281 | 1379 | 1483 | 1583 | 1680 | 1853 | 1875 | 2184 | 2388 | 2550 | 2718 | 2871 | 3176 | 3182 | 3724 |
| 66 (167.7) | 906 | 1013 | 1121 | 1225 | 1329 | 1431 | 1543 | 1647 | 1752 | 1931 | 1957 | 2282 | 2493 | 2671 | 2846 | 3014 | 3336 | 3346 | 3922 |
| 72 (182.9) | 925 | 1037 | 1155 | 1269 | 1380 | 1487 | 1602 | 1713 | 1823 | 2017 | 2040 | 2378 | 2606 | 2786 | 2976 | 3160 | 3504 | 3512 | 4115 |
| 78 (198.2) | 942 | 1062 | 1187 | 1306 | 1427 | 1543 | 1658 | 1782 | 1897 | 2099 | 2125 | 2476 | 2718 | 2904 | 3103 | 3304 | 3672 | 3680 | 4304 |
| 84 (213.4) | 959 | 1087 | 1221 | 1344 | 1473 | 1596 | 1723 | 1845 | 1966 | 2178 | 2202 | 2571 | 2826 | 3031 | 3242 | 3439 | 3823 | 3832 | 4495 |
| 90 (228.6) | 981 | 1118 | 1255 | 1384 | 1523 | 1650 | 1782 | 1910 | 2036 | 2258 | 2282 | 2667 | 2930 | 3149 | 3369 | 3569 | 3988 | 4000 | 4692 |
| 96 (243.9) | 999 | 1144 | 1290 | 1426 | 1574 | 1712 | 1845 | 1987 | 2118 | 2351 | 2373 | 2775 | 3054 | 3283 | 3513 | 3730 | 4183 | 4189 | 4909 |
| 108 (274.4) | 1016 | 1172 | 1326 | 1466 | 1623 | 1770 | 1917 | 2057 | 2193 | 2438 | 2460 | 2882 | 3176 | 3426 | 3670 | 3884 | 4356 | 4362 | 5125 |
| 120 (304.8) | 1069 | 1204 | 1364 | 1512 | 1680 | 1827 | 1981 | 2129 | 2272 | 2527 | 2549 | 2989 | 3294 | 3562 | 3812 | 4030 | 4544 | 4553 | 5352 |

Enchantment Blackout 3/4" Single Cell*

| | | | | | |
|---------------|------|-------------|------|---------------|------|
| Genteel Beige | 0625 | Regal Gray | 0627 | Silver Shadow | 0629 |
| Glacial Gray | 0626 | Ridged Sand | 0628 | | |

*Color coordinated with Enchantment Light Filtering

Infuse Light Filtering 3/4" Single Cell*

| | | | | | |
|----------------|------|-----------------|------|------------------|------|
| Aspen | 0950 | Indigo Intrigue | 0954 | Taupe Perfection | 0958 |
| Autumn Gold | 0951 | Rivermist | 0955 | Vanilla Cream | 0959 |
| Balanced Beige | 0952 | Savvy Slate | 0956 | | |
| Ecru | 0953 | Subtle Sage | 0957 | | |

*Color coordinated with Infuse Blackout

| Montage Blackout 3/4" Single Cell* | | | | | |
|------------------------------------|------|--------------|------|-----------|------|
| Chroma Gray | 0615 | Gray Granite | 0617 | Gray Moon | 0619 |
| Cultivated Khaki | 0616 | Gray Hues | 0618 | | |

*Color coordinated with Montage Light Filtering

| Prestige Blackout 3/4" Single Cell* | | | | | |
|-------------------------------------|------|--------------|------|---------------------|------|
| Beige Influence | 0595 | Pale Pebble | 0597 | Sophisticated Stone | 0599 |
| Gray Juniper | 0596 | Refined Flax | 0598 | | |

*Color coordinated with Prestige Light Filtering

| Sanctuary 1/2" Double Cell* | | | | | |
|-----------------------------|------|-----------------|------|-----------------|------|
| Arctic White | 1451 | Gray Mystique | 1469 | Sandpiper | 1477 |
| Blue Breeze | 1464 | Harvested Wheat | 1449 | Sculpture Gray | 1471 |
| Caribou | 1454 | Hushed Gray | 1479 | Seascape | 1467 |
| Champagne | 1453 | Irish Coffee | 1444 | Shell White | 1461 |
| Cool Amethyst | 1473 | Light Azure | 1463 | Shoreline Sand | 1450 |
| Cornerstone | 1478 | Liquid Silver | 1440 | Smoky Quartz | 1468 |
| Dark Taupe | 1472 | Midnight Sky | 1448 | Sweetwater Sage | 1460 |
| Eggnog | 1446 | Navy Charm | 1466 | Timberwolf Gray | 1445 |
| Elusive Gray | 1474 | Nostalgic Beige | 1459 | Tuscan Red | 1458 |
| Freshwater Pearl | 1442 | Pink Rose | 1465 | Umber | 1476 |
| Gentle Beige | 1457 | Powder Gray | 1452 | Villa | 1443 |
| Gentle Tan | 1447 | Rich Burgundy | 1462 | Whisper White | 1441 |
| Golden Wheat | 1470 | River Delta | 1456 | | |
| Gray Fedora | 1455 | River Stone | 1475 | | |

*Color coordinates with Splendor (light filtering).

| Sanctuary 3/4" Single Cell* | | | | | |
|-----------------------------|------|-----------------|------|-----------------|------|
| Arctic White | 1251 | Gray Mystique | 1269 | Sandpiper | 1277 |
| Blue Breeze | 1264 | Harvested Wheat | 1249 | Sculpture Gray | 1271 |
| Caribou | 1254 | Hushed Gray | 1279 | Seascape | 1267 |
| Champagne | 1253 | Irish Coffee | 1244 | Shell White | 1261 |
| Cool Amethyst | 1273 | Light Azure | 1263 | Shoreline Sand | 1250 |
| Cornerstone | 1278 | Liquid Silver | 1240 | Smoky Quartz | 1268 |
| Dark Taupe | 1272 | Midnight Sky | 1248 | Sweetwater Sage | 1260 |
| Eggnog | 1246 | Navy Charm | 1266 | Timberwolf Gray | 1245 |
| Elusive Gray | 1274 | Nostalgic Beige | 1259 | Tuscan Red | 1258 |
| Freshwater Pearl | 1242 | Pink Rose | 1265 | Umber | 1276 |
| Gentle Beige | 1257 | Powder Gray | 1252 | Villa | 1243 |
| Gentle Tan | 1247 | Rich Burgundy | 1262 | Whisper White | 1241 |
| Golden Wheat | 1270 | River Delta | 1256 | | |
| Gray Fedora | 1255 | River Stone | 1275 | | |

*Color coordinates with Splendor (light filtering).

| Splendor 1 1/4" Single Cell** | | | | | |
|-------------------------------|------|---------------|------|---------------|------|
| Cornerstone | 0124 | Liquid Silver | 0120 | Shell White | 0122 |
| Hushed Gray | 0125 | Sandpiper | 0123 | Whisper White | 0121 |

**Color coordinates with Sanctuary (blackout).

Price Group O: Couture Light Filtering 3/4" (2.0 cm) Single Cell, Simply Sheer 3/4" (2.0 cm) Single Cell, Valletta 3/4" (2.0 cm) Single Cell

Graber Slide-Vue

| Height up to inches (cm) ↓ | Width up to inches (cm) → | | | | | | | | | | | | | | | | | | |
|-------------------------------|---------------------------|--------------|--------------|---------------|-------------|---------------|---------------|---------------|---------------|---------------|---------------|---------------|----------------|----------------|----------------|----------------|----------------|--------------|----------------|
| | 24 (61) | 30 (76.2) | 36 (91.5) | 42 (106.7) | 48 (122) | 54 (137.2) | 60 (152.4) | 66 (167.7) | 72 (182.9) | 78 (198.2) | 84 (213.4) | 96 (243.9) | 108 (274.4) | 120 (304.8) | 132 (335.3) | 144 (365.8) | 156 (396.3) | 174 (442) | 192 (487.7) |
| 36 (91.5) | 833 | 922 | 984 | 1066 | 1139 | 1212 | 1290 | 1374 | 1446 | 1571 | 1597 | 1882 | 2037 | 2150 | 2280 | 2388 | 2597 | 2606 | 3099 |
| 42 (106.7) | 843 | 948 | 1018 | 1104 | 1186 | 1263 | 1353 | 1440 | 1523 | 1659 | 1686 | 1974 | 2144 | 2281 | 2414 | 2541 | 2774 | 2782 | 3288 |
| 48 (122) | 857 | 950 | 1051 | 1147 | 1230 | 1319 | 1409 | 1508 | 1592 | 1742 | 1770 | 2069 | 2257 | 2394 | 2549 | 2682 | 2941 | 2955 | 3470 |
| 54 (137.2) | 882 | 984 | 1087 | 1187 | 1282 | 1373 | 1473 | 1576 | 1664 | 1827 | 1854 | 2170 | 2359 | 2512 | 2683 | 2828 | 3113 | 3121 | 3670 |
| 60 (152.4) | 905 | 1010 | 1123 | 1228 | 1325 | 1428 | 1536 | 1640 | 1740 | 1918 | 1945 | 2261 | 2473 | 2640 | 2812 | 2974 | 3288 | 3296 | 3853 |
| 66 (167.7) | 930 | 1041 | 1160 | 1266 | 1378 | 1483 | 1597 | 1705 | 1813 | 1999 | 2025 | 2360 | 2578 | 2768 | 2950 | 3121 | 3452 | 3465 | 4062 |
| 72 (182.9) | 950 | 1069 | 1195 | 1316 | 1429 | 1540 | 1659 | 1775 | 1888 | 2089 | 2112 | 2465 | 2698 | 2884 | 3080 | 3273 | 3630 | 3636 | 4260 |
| 78 (198.2) | 970 | 1099 | 1229 | 1353 | 1477 | 1597 | 1717 | 1845 | 1966 | 2174 | 2199 | 2560 | 2812 | 3007 | 3213 | 3420 | 3801 | 3810 | 4456 |
| 84 (213.4) | 992 | 1124 | 1263 | 1395 | 1525 | 1653 | 1783 | 1910 | 2035 | 2256 | 2281 | 2662 | 2926 | 3137 | 3357 | 3562 | 3957 | 3968 | 4652 |
| 90 (228.6) | 1016 | 1158 | 1301 | 1434 | 1578 | 1708 | 1845 | 1977 | 2109 | 2335 | 2360 | 2761 | 3035 | 3259 | 3489 | 3696 | 4130 | 4139 | 4857 |

| | | | | | | | | | | | | | | | | | | | |
|-------------|------|------|------|------|------|------|------|------|------|------|------|------|------|------|------|------|------|------|------|
| 96 (243.9) | 1041 | 1186 | 1337 | 1477 | 1627 | 1764 | 1904 | 2047 | 2184 | 2421 | 2446 | 2863 | 3144 | 3380 | 3616 | 3832 | 4302 | 4313 | 5067 |
| 108 (274.4) | 1067 | 1217 | 1373 | 1522 | 1680 | 1815 | 1966 | 2116 | 2261 | 2502 | 2528 | 2964 | 3254 | 3505 | 3749 | 3972 | 4472 | 4491 | 5274 |
| 120 (304.8) | 1091 | 1246 | 1404 | 1561 | 1731 | 1873 | 2025 | 2187 | 2335 | 2589 | 2615 | 3065 | 3362 | 3630 | 3877 | 4107 | 4647 | 4662 | 5480 |

| Couture Light Filtering 3/4" Single Cell* | | | | | |
|---|------|--------------|------|---------------|------|
| Feather White | 0130 | Noble Pewter | 0133 | Peaceful Gray | 0135 |
| Heron Plume | 0131 | Jute | 0134 | | |

*Color coordinates with Couture Blackout

| Simply Sheer 3/4" Single Cell | | | | | |
|-------------------------------|------|-------|------|---------|------|
| Almond | 2152 | Mocha | 2154 | Whisper | 2150 |

| Valletta 3/4" Single Cell | | | | | |
|---------------------------|------|---------------|------|--------------|------|
| Adirondack | 2855 | Coconut Cream | 2851 | Trevi | 2857 |
| Atlantic Frost | 2858 | Manila | 2852 | Walnut Shell | 2856 |
| Cinnamon Spice | 0642 | Simply White | 2850 | | |
| Crisp Carbon | 0643 | Spring Fawn | 2854 | | |

Price Group P: Infuse Blackout 3/4" (2.0 cm) Single Cell, Kinsley Light Filtering 3/4" (2.0 cm) Single Cell, Sanctuary 1 1/4" (3.2 cm) Single Cell, Valletta 1 1/4" (3.2 cm) Single Cell

Graber Slide-Vue

| Height up to inches (cm) ↓ | Width up to inches (cm) → | | | | | | | | | | | | | | | | | | |
|-------------------------------|---------------------------|--------------|--------------|---------------|-------------|---------------|---------------|---------------|---------------|---------------|---------------|---------------|----------------|----------------|----------------|----------------|----------------|--------------|----------------|
| | 24 (61) | 30 (76.2) | 36 (91.5) | 42 (106.7) | 48 (122) | 54 (137.2) | 60 (152.4) | 66 (167.7) | 72 (182.9) | 78 (198.2) | 84 (213.4) | 96 (243.9) | 108 (274.4) | 120 (304.8) | 132 (335.3) | 144 (365.8) | 156 (396.3) | 174 (442) | 192 (487.7) |
| 36 (91.5) | 941 | 1037 | 1144 | 1238 | 1324 | 1409 | 1500 | 1597 | 1684 | 1830 | 1860 | 2189 | 2368 | 2501 | 2648 | 2778 | 3019 | 3033 | 3607 |
| 42 (106.7) | 970 | 1066 | 1184 | 1284 | 1379 | 1471 | 1575 | 1675 | 1772 | 1930 | 1959 | 2294 | 2494 | 2650 | 2809 | 2956 | 3223 | 3236 | 3823 |
| 48 (122) | 994 | 1107 | 1225 | 1334 | 1433 | 1535 | 1639 | 1756 | 1852 | 2026 | 2059 | 2407 | 2625 | 2786 | 2965 | 3119 | 3423 | 3436 | 4037 |
| 54 (137.2) | 1025 | 1144 | 1265 | 1381 | 1490 | 1595 | 1713 | 1832 | 1936 | 2125 | 2156 | 2524 | 2745 | 2920 | 3122 | 3291 | 3621 | 3632 | 4272 |
| 60 (152.4) | 1051 | 1176 | 1307 | 1428 | 1543 | 1660 | 1784 | 1908 | 2024 | 2233 | 2261 | 2630 | 2878 | 3071 | 3271 | 3462 | 3823 | 3836 | 4482 |
| 66 (167.7) | 1081 | 1210 | 1352 | 1474 | 1603 | 1724 | 1860 | 1986 | 2111 | 2329 | 2356 | 2748 | 3001 | 3220 | 3430 | 3632 | 4019 | 4029 | 4723 |
| 72 (182.9) | 1107 | 1245 | 1389 | 1530 | 1664 | 1793 | 1930 | 2064 | 2198 | 2429 | 2458 | 2864 | 3140 | 3356 | 3585 | 3806 | 4218 | 4230 | 4956 |
| 78 (198.2) | 1128 | 1279 | 1429 | 1575 | 1720 | 1860 | 1999 | 2148 | 2285 | 2529 | 2558 | 2980 | 3271 | 3498 | 3738 | 3979 | 4423 | 4432 | 5184 |
| 84 (213.4) | 1154 | 1308 | 1471 | 1620 | 1776 | 1922 | 2075 | 2224 | 2364 | 2624 | 2650 | 3095 | 3401 | 3648 | 3906 | 4140 | 4605 | 4616 | 5410 |
| 90 (228.6) | 1182 | 1347 | 1514 | 1669 | 1834 | 1987 | 2148 | 2300 | 2451 | 2719 | 2748 | 3215 | 3531 | 3792 | 4058 | 4300 | 4802 | 4816 | 5653 |
| 96 (243.9) | 1210 | 1379 | 1554 | 1720 | 1894 | 2052 | 2215 | 2383 | 2541 | 2815 | 2844 | 3330 | 3657 | 3931 | 4209 | 4460 | 5008 | 5017 | 5896 |
| 108 (274.4) | 1241 | 1416 | 1595 | 1771 | 1953 | 2114 | 2285 | 2463 | 2630 | 2914 | 2940 | 3449 | 3786 | 4076 | 4360 | 4618 | 5205 | 5223 | 6136 |
| 120 (304.8) | 1269 | 1452 | 1636 | 1815 | 2013 | 2178 | 2356 | 2544 | 2719 | 3010 | 3040 | 3567 | 3914 | 4218 | 4509 | 4777 | 5406 | 5423 | 6376 |

| Infuse Blackout 3/4" Single Cell* | | | | | |
|-----------------------------------|------|-----------------|------|------------------|------|
| Aspen | 3950 | Indigo Intrigue | 3954 | Taupe Perfection | 3958 |
| Autumn Gold | 3951 | Rivermist | 3955 | Vanilla Cream | 3959 |
| Balanced Beige | 3952 | Savvy Slate | 3956 | | |
| Ecrú | 3953 | Subtle Sage | 3957 | | |

*Color coordinated with Infuse Light Filtering

| Kinsley Light Filtering 3/4" Single Cell* | | | | | |
|---|------|-----------------|------|------------------|------|
| Aspen | 0720 | Indigo Intrigue | 0727 | Taupe Perfection | 0728 |
| Autumn Gold | 0722 | Rivermist | 0729 | Vanilla Cream | 0724 |
| Balanced Beige | 0723 | Savvy Slate | 0725 | | |
| Ecrú | 0721 | Subtle Sage | 0726 | | |

*Color coordinated with Kinsley Blackout

| Sanctuary 1 1/4" Single Cell* | | | | | |
|-------------------------------|------|-------------|------|---------------|------|
| Hushed Gray | 0113 | Shell White | 0111 | Whisper White | 0110 |
| Sandpiper | 0112 | | | | |

*Color coordinates with Splendor (light filtering).

| Valletta 1 1/4" Single Cell | | | | | |
|-----------------------------|------|--------------|------|-------|------|
| Coconut Cream | 0662 | Simply White | 0660 | Trevi | 0661 |
| Manila | 0663 | | | | |

*Color coordinates with Splendor (light filtering).

Price Group Q: Couture Blackout 3/4" (2.0 cm) Single Cell, Kinsley Blackout 3/4" (2.0 cm) Single Cell

Graber Slide-Vue

| Height up to inches (cm) ↓ | Width up to inches (cm) → | | | | | | | | | | | | | | | | | | |
|-------------------------------|---------------------------|--------------|--------------|---------------|-------------|---------------|---------------|---------------|---------------|---------------|---------------|---------------|----------------|----------------|----------------|----------------|----------------|--------------|----------------|
| | 24 (61) | 30 (76.2) | 36 (91.5) | 42 (106.7) | 48 (122) | 54 (137.2) | 60 (152.4) | 66 (167.7) | 72 (182.9) | 78 (198.2) | 84 (213.4) | 96 (243.9) | 108 (274.4) | 120 (304.8) | 132 (335.3) | 144 (365.8) | 156 (396.3) | 174 (442) | 192 (487.7) |
| 36 (91.5) | 1178 | 1299 | 1432 | 1550 | 1658 | 1765 | 1878 | 2000 | 2108 | 2291 | 2329 | 2741 | 2964 | 3130 | 3316 | 3478 | 3781 | 3796 | 4516 |
| 42 (106.7) | 1215 | 1336 | 1484 | 1609 | 1726 | 1841 | 1971 | 2098 | 2218 | 2417 | 2455 | 2872 | 3122 | 3320 | 3516 | 3699 | 4037 | 4053 | 4787 |
| 48 (122) | 1245 | 1384 | 1532 | 1669 | 1794 | 1919 | 2054 | 2199 | 2318 | 2536 | 2577 | 3013 | 3286 | 3488 | 3715 | 3903 | 4286 | 4301 | 5052 |
| 54 (137.2) | 1283 | 1432 | 1582 | 1730 | 1866 | 1998 | 2144 | 2294 | 2425 | 2660 | 2700 | 3161 | 3436 | 3657 | 3908 | 4118 | 4534 | 4546 | 5349 |
| 60 (152.4) | 1317 | 1472 | 1637 | 1788 | 1932 | 2079 | 2235 | 2388 | 2532 | 2793 | 2830 | 3294 | 3603 | 3844 | 4094 | 4334 | 4787 | 4803 | 5614 |
| 66 (167.7) | 1352 | 1516 | 1692 | 1845 | 2006 | 2158 | 2329 | 2487 | 2642 | 2915 | 2950 | 3439 | 3756 | 4032 | 4294 | 4546 | 5032 | 5045 | 5913 |
| 72 (182.9) | 1384 | 1558 | 1741 | 1915 | 2083 | 2243 | 2417 | 2584 | 2752 | 3042 | 3074 | 3586 | 3931 | 4203 | 4488 | 4765 | 5280 | 5296 | 6204 |
| 78 (198.2) | 1413 | 1601 | 1789 | 1971 | 2154 | 2329 | 2502 | 2688 | 2861 | 3166 | 3203 | 3730 | 4094 | 4380 | 4680 | 4981 | 5537 | 5549 | 6491 |
| 84 (213.4) | 1445 | 1638 | 1841 | 2029 | 2224 | 2407 | 2599 | 2784 | 2960 | 3284 | 3320 | 3875 | 4259 | 4567 | 4891 | 5184 | 5766 | 5779 | 6774 |
| 90 (228.6) | 1482 | 1687 | 1895 | 2090 | 2295 | 2488 | 2688 | 2880 | 3069 | 3403 | 3439 | 4024 | 4421 | 4748 | 5078 | 5384 | 6012 | 6030 | 7077 |
| 96 (243.9) | 1516 | 1726 | 1944 | 2154 | 2371 | 2569 | 2774 | 2982 | 3179 | 3525 | 3562 | 4169 | 4578 | 4923 | 5270 | 5583 | 6268 | 6283 | 7380 |
| 108 (274.4) | 1552 | 1774 | 1998 | 2216 | 2446 | 2647 | 2861 | 3084 | 3294 | 3646 | 3680 | 4318 | 4739 | 5103 | 5458 | 5782 | 6517 | 6540 | 7681 |
| 120 (304.8) | 1588 | 1817 | 2047 | 2272 | 2520 | 2727 | 2950 | 3184 | 3403 | 3767 | 3807 | 4467 | 4899 | 5280 | 5646 | 5981 | 6766 | 6790 | 7985 |

| Couture Blackout 3/4" Single Cell | | | | | |
|--|------|--------------|------|---------------|------|
| Feather White | 1130 | Jute | 1134 | Peaceful Gray | 1135 |
| Heron Plume | 1131 | Noble Pewter | 1133 | | |

*Color coordinated with Couture Light Filtering

| Kinsley Blackout 3/4" Single Cell | | | | | |
|--|------|-----------------|------|------------------|------|
| Aspen | 1720 | Indigo Intrigue | 1727 | Taupe Perfection | 1728 |
| Autumn Gold | 1722 | Rivermist | 1729 | Vanilla Cream | 1724 |
| Balanced Beige | 1723 | Savvy Slate | 1725 | | |
| Ecrú | 1721 | Subtle Sage | 1726 | | |

*Color coordinated with Kinsley Light Filtering

Options Pricing

Perfect Arches: Half Circle

Width up to inches (cm) →

24 30 36 42 48 54 60 66 72 84
 (61) (76.2) (91.5) (106.7) (122) (137.2) (152.4) (167.7) (182.9) (213.4)

| | 24 | 30 | 36 | 42 | 48 | 54 | 60 | 66 | 72 | 84 |
|---------------|-----|-----|-----|-----|-----|-----|------|------|------|------|
| Price Group A | 188 | 206 | 235 | 259 | 297 | 341 | 383 | 431 | 475 | 524 |
| Price Group B | 199 | 218 | 251 | 276 | 316 | 363 | 406 | 457 | 503 | 555 |
| Price Group C | 256 | 280 | 320 | 352 | 405 | 464 | 520 | 586 | 644 | 712 |
| Price Group D | 277 | 302 | 346 | 380 | 438 | 502 | 563 | 631 | 696 | 770 |
| Price Group E | 282 | 308 | 353 | 388 | 447 | 512 | 574 | 644 | 711 | 785 |
| Price Group F | 327 | 356 | 409 | 449 | 519 | 594 | 665 | 748 | 825 | 911 |
| Price Group G | 341 | 371 | 425 | 467 | 540 | 618 | 693 | 776 | 858 | 947 |
| Price Group H | 396 | 431 | 493 | 543 | 626 | 716 | 804 | 901 | 994 | 1099 |
| Price Group I | 520 | 567 | 649 | 713 | 824 | 940 | 1056 | 1184 | 1307 | 1445 |

Non-Perfect Arches

Width up to inches (cm) →

24 30 36 42 48 54 60 66 72 84
 (61) (76.2) (91.5) (106.7) (122) (137.2) (152.4) (167.7) (182.9) (213.4)

| | 24 | 30 | 36 | 42 | 48 | 54 | 60 | 66 | 72 | 84 |
|---------------|-----|-----|-----|-----|------|------|------|------|------|------|
| Price Group A | 242 | 269 | 305 | 339 | 390 | 445 | 497 | 564 | 618 | 679 |
| Price Group B | 258 | 286 | 322 | 362 | 414 | 472 | 527 | 598 | 654 | 719 |
| Price Group C | 331 | 367 | 414 | 462 | 529 | 606 | 677 | 766 | 838 | 921 |
| Price Group D | 356 | 396 | 447 | 498 | 572 | 655 | 730 | 827 | 906 | 996 |
| Price Group E | 364 | 405 | 457 | 510 | 583 | 668 | 747 | 843 | 924 | 1015 |
| Price Group F | 422 | 469 | 529 | 591 | 677 | 775 | 865 | 979 | 1071 | 1178 |
| Price Group G | 439 | 488 | 550 | 614 | 703 | 806 | 900 | 1018 | 1115 | 1226 |
| Price Group H | 511 | 566 | 639 | 712 | 814 | 936 | 1044 | 1180 | 1293 | 1423 |
| Price Group I | 670 | 743 | 839 | 936 | 1071 | 1229 | 1373 | 1552 | 1700 | 1870 |

| Option | |
|---|--|
| Bottom Up/Top Down Cord Lift | 99 |
| Bottom Up/Top Down Cordless Lift | 99 No additional charge or cordless lift |
| Continuous-Loop Lift (recommended for large, heavy shades) | 99 |
| Cord Cleats | Clear: No charge 10 Solid brass 5 Antique brass |
| Cord Winder | 8 |
| Cordless Lift | No charge |
| Cut-Outs | 67 |
| Lightblocking Strip | No charge |
| Motorized Lift | See motorization product information guide |
| Multiple Shades on One Headrail | If less than or equal to 144" (365.8 cm), surcharge applies: 99 Two-on-one headrail 99 Three-on-one headrail |
| Perfect-Vue® Shade—Cord Lift | See price charts |
| Perfect-Vue Shade—Cordless Lift | See price chart and add one cordless lift surcharge |
| Reversible Fabrics | No charge |
| Room Darkening Side Channels | 108 |
| Sky Pole | 46 3 to 6 1/2 feet (91.5 cm to 198.2 cm) 70 5 to 9 1/2 feet (152.4 cm to 289.6 cm) |
| Skytrack Skylight | 123 |
| Sun Up/Sun Down—Cord Lift | Price as two separate cord lift shades and combine both prices for total shade cost |
| Sun Up/Sun Down—Cordless Lift | Price as two separate cord lift shades and combine both prices for total shade cost; no charge for cordless lift |
| Template Service | 25 net |
| Top Down Only | 83 plus the continuous-loop lift surcharge |
| Wood Cornices and Valances | See wood cornices and valances product information guide |
| Specialty Shapes | |
| Angled Top/Angled Bottom | 164 add to price as cord lift shade using angled width and longest height |
| Arch Over Standard Cord Lift | Price as an arch and add to the cost of a cord lift shade |
| Octagon, Hexagon, or Trapezoid | 251 add to price as cord lift shade using widest width and largest height |
| Perfect Arches and Non-Perfect Arches | See arch pricing |