

# CORNICES, VALANCES, AND PALLADIAN WINDOW SHELF

## Table of Contents

### Features

Wood Characteristics . . . . .	2
Wood Cornices . . . . .	3
Wood Valances . . . . .	3
Composite and Faux Wood Valances . . . . .	3
Palladian Window Shelf . . . . .	3

### Size Considerations

Cornices and Valances . . . . .	4
Palladian Window Shelf . . . . .	4

### Options

Wood Cornices . . . . .	5
Wood Valances . . . . .	6
Composite and Faux Wood Valances . . . . .	7
Decorative Keystones . . . . .	8
Splicing Requirements . . . . .	8
Palladian Window Shelf . . . . .	9

### General Information

Valance Returns: Horizontal Blinds . . . . .	10-11
Wood Valance Returns . . . . .	12-14
Wood Cornice Returns . . . . .	15-16
Composite and Faux Wood Valance Returns . . . . .	17
How to Measure for Valance Returns . . . . .	18
How to Measure and Order Cornices and Valances . . . . .	19
How to Measure a Special Splice Location . . . . .	20
Custom Color . . . . .	20
Mounting Brackets . . . . .	21

### Price Charts and Options Pricing

Wood Cornice Pricing . . . . .	23
Decorative Cornice Keystone Pricing . . . . .	23
Custom Color Pricing . . . . .	23
Wood Valance Pricing . . . . .	24
Decorative Wood Valance Keystone Pricing . . . . .	24
Custom Color Pricing . . . . .	24
Composite and Faux Wood Valance Pricing . . . . .	24
Palladian Window Shelf Pricing . . . . .	24

# GRABER®

UNITED STATES PRICE LIST • FEBRUARY 2019

# Features

Cornices and valances easily lend an impressive touch to windows and doors. Used on their own or over window treatments, cornices and valances are as decorative as they are functional.

Palladian window shelves create a mounting surface for unique or difficult installations.

- Unique styles of wood cornices, wood valances, and faux wood valances provide the perfect solution for any décor
- Wood cornices and valances are crafted from premium North American hardwood and are available in all paints and stains to coordinate with Graber® Wood Blinds, as well as unfinished
- Dress up a drab window
- Enlarge a window
- Keystones are included with a spliced cornice or wood valance
- Additional keystones are available as a surcharge option for cornices or wood valances that do not require splices

## Wood Characteristics



Flat Grain



Grain Change



Tiger Striping



Burl/Bird's Eye

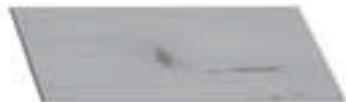

Pin Knots



Mineral Marks



Knotty Pine/  
Rustic



Knotty Pine/  
Rustic

Wood used to manufacture Graber Wood Blinds has many natural characteristics which make it truly unique...no two pieces of hardwood are alike. The following are all natural characteristics of wood and we do not consider them to be defects:

- Grain—The direction, size, and appearance of wood fibers vary greatly depending on where the wood is cut from within the tree
- Tiger Striping—Occurs when a tree develops wavy grain, due to genetics, soil content, or other natural scenarios
- Burl Grain—Formed from an irregular growth on the outer edge of the tree
- Bird's Eye—Small area on the surface of the board where fibers are contorted to form circular figures that resemble birds' eyes
- Pin Knots—Vary in size, shape, structure, and color
- Mineral Marks—Dark or discolored area caused by minerals which the tree extracts from the water or soil; can be either a streak or a stain, usually blackish blue
- Knotty Pine/Rustic—Material contains markings that are more extreme than in standard products; the number and degree of marking will vary throughout the blind

Please be assured that these markings in no way affect the durability or the structural integrity of the blind.

Natural variations in color and grain effect are inherent in the beauty of wood. These variations are within established industry guidelines and should be expected. When two or more pieces of wood are spliced together to create wider valances or cornices, there may be variations in the dye lot and grain between the sections. In addition, valances and cornices may stain slightly darker or lighter than the samples shown in the sample books and selectors.

## Features

### Wood Cornices

- Crafted from premium North American hardwood
- Fine furniture-quality finish
- L-brackets are included for easy installation
- Cornices are available in all paints and stains to coordinate with Graber® Traditions® Wood Blinds, as well as unfinished or custom color
- Keystones are included with spliced cornices and are available as a surcharge option for cornices that do not require a splice

### Wood Valances

- Crafted from premium North American hardwood
- Fine furniture-quality finish
- Includes mounting hardware for specified product use
- Valances are available in all paints and stains to coordinate with Graber Wood Blinds, as well as unfinished or custom color
- Keystones are included with spliced valances and are available as a surcharge option for valances that do not require a splice

### Composite and Faux Wood Valances

- Composite and faux wood options are ideal for a finishing look in a high humidity room
- Includes mounting hardware for specified product use

### Palladian Window Shelf

- Crafted from premium North American hardwood
- Fine furniture-quality finish
- Available in all paints and stains to coordinate with Graber Wood Blinds, as well as unfinished or custom color
- Create a mounting surface for unique or difficult installations
- Available in depths from 4" (10.2 cm) to as narrow as 2" (5.1 cm)
- Mounting hardware included

## Size Considerations

### Cornices and Valances

Type of Valance or Cornice	Minimum Width		Maximum Width without Splicing		Maximum Width with Splicing	
	Inside Mount inches (cm)	Outside Mount inches (cm)	Inside Mount No Returns inches (cm)	Outside Mount or Inside Mount with Returns inches (cm)	Inside Mount inches (cm)	Outside Mount inches (cm)
2½" (6.4 cm) Classic Barnwood Valance†	8¼ (21.0)	8 (20.4)	100¼ (254.7)	98% (249.9)	300¼ (764.0)	298¾ (759.2)
3" (7.7 cm) Classic Wood Valance	8¼ (21.0)	8 (20.4)	100¼ (254.7)	98% (249.9)	300¼ (764.0)	298¾ (759.2)
3½" (8.9 cm) Craftsman Wood Valance	8¼ (21.0)	8 (20.4)	100¼ (254.7)	98% (249.9)	300¼ (764.0)	298¾ (759.2)
3½" (8.9 cm) Legacy Wood Valance	8¼ (21.0)	8 (20.4)	100¼ (254.7)	98% (249.9)	300¼ (764.0)	298¾ (759.2)
4½" (11.5 cm) Symphony Wood Valance/Cornice^	8¼ (21.0)	8 (20.4)	100¼ (254.7)	98% (249.9)	300¼ (764.0)	298¾ (759.2)
3" (7.7 cm) Classic Composite or Faux Wood Valance†	8¼ (21.0)	8 (20.4)	106% (270.9)	105% (267.7)	300 (762.0)	298¾ (758.9)
3" (7.7 cm) Majestic Composite or Faux Wood Valance†	8¼ (21.0)	8 (20.4)	106% (270.9)	105% (267.7)	300 (762.0)	298¾ (758.9)
5½" (14.0 cm) Noble Wood Cornice^	8¼ (21.0)	8 (20.4)	94 (238.8)	92% (234.0)	366 (929.7)	366 (929.7)
7½" (19.1 cm) Noble Wood Cornice^	8¼ (21.0)	8 (20.4)	94 (238.8)	91% (232.1)	366 (929.7)	366 (929.7)
5½" (14.0 cm) Regal Wood Cornice^	8¼ (21.0)	8 (20.4)	94 (238.8)	91% (231.5)	366 (929.7)	366 (929.7)
7½" (19.1 cm) Regal Wood Cornice^	8¼ (21.0)	8 (20.4)	94 (238.8)	90 (228.6)	366 (929.7)	366 (929.7)

^Inside mount wood cornices that require a keystone cannot be mounted flush to the top of the window casing. There will be approximately a ¼" (0.7 cm) gap at the top and the installation brackets may be visible with this application.

†Keystones not available on authentic hardwood, barnwood, distressed wood, in sandblast finish, composite, or faux wood valances.

**NOTE:** Cornices and valances wider than the widths shown in the chart above will be manufactured in multiple sections. The sections must be assembled during installation. Customer may request specific locations for the splices as long as it does not exceed our maximum single piece size. All requests for additional cornice or wood valance splices require a keystone. The keystone surcharge applies to each additional splice.

These formulas are used to calculate BACKSIDE valance measurements by product type.

Product Type	Mount Type	Return Type	Formula
All Except: • Natural Drapes • Sheer Verticals • Artisan Fabric Roman Shades • Other Applications	Inside mount	No returns	OW - ¼" (0.2 cm)
	Outside mount	With returns	OW + ¾" (2.0 cm)
Natural Drapes	Inside mount	No returns	OW - ¼" (0.2 cm)
	Outside mount	With returns	OW + 1" (2.6 cm)
Sheer Verticals	Inside mount	No returns	OW - ¼" (0.2 cm)
	Outside mount	With returns	OW + ½" (1.3 cm)
Artisan Fabric Roman Shades	Inside mount	No returns	OW + ¾" (2.0 cm)
	Outside mount	With returns	OW + 4" (10.2 cm)
Other Applications	Inside mount	No returns	Ordered width
	Outside mount	With returns	Ordered width

These formulas are used to calculate BACKSIDE cornice measurements by product type.

Product Type	Mount Type	Return Type	Formula
All Except: • Natural Drapes • Sheer Verticals • Artisan Fabric Roman Shades • Other Applications	Inside mount	No returns	OW - ¼" (0.2 cm)
	Outside mount	With returns	OW + ¾" (2.0 cm)
Natural Drapes	Inside mount	No returns	OW - ¼" (0.2 cm)
	Outside mount	With returns	OW + 1" (2.6 cm)
Sheer Verticals	Inside mount	No returns	OW - ¼" (0.2 cm)
	Outside mount	With returns	OW + ½" (1.3 cm)
Artisan Fabric Roman Shades	Inside mount	No returns	OW - ¼" (0.2 cm)
	Outside mount	With returns	OW + 2" (5.1 cm)
Other Applications	Inside mount	No returns	Ordered width
	Outside mount	With returns	Ordered width

If the product option of other is selected during entry, the backside cornice/valance measurement will be the exact width entered. There will be no additions or deductions taken. Cornice or valance return size must be specified. Soft drapery falls within the 'other applications' category.

### Palladian Window Shelf

	Minimum Width Inside Mount Only inches (cm)	Maximum Width Inside Mount Only inches (cm)	Minimum Depth inches (cm)	Maximum Depth inches (cm)
Palladian Window Shelf	7 (17.8)	96 (243.9)	2 (5.1)	4 (10.2)

**NOTE:** Inside mount application only. The finished shelf will be ordered width less ¼" (0.2 cm). The shelf is designed for end mounting; no center supports are available. End mounting brackets must be mounted to a flat vertical surface. If installation is inside an arch, the top of the palladian shelf must be mounted at or below the start of the arch curve. Shelf can be installed in a vertical application to divide a large window. Depending on the width of the window opening and the weight of the blind or shade, deflection up to ½" (1.3 cm) may occur.

# Options

## Wood Cornices

- Crafted from premium North American hardwood
- Fine furniture-quality finish
- Installation hardware is included for easy installation
- Cornices available in all paints and stains to coordinate with Graber® Wood Blinds, as well as unfinished or with custom color
- Inside mount has straight cut ends, no returns, no dust cover
- Outside mount has mitered corners, returns, and a dust cover\* to conceal the top of the blind
- Custom returns may be ordered for outside mount up to 8" (20.4 cm); minimum return is ½" (1.3 cm)
- Cornices not available on bay or corner windows
- Single side return available; opposite end will be straight cut

\*Dust cover is unfinished and will not match selected color.

**NOTE:** Wood cornice will be shipped separate from blinds. Manufacturer recommends installing blind and cornice at the same time.

Regal Wood—Outside Mount

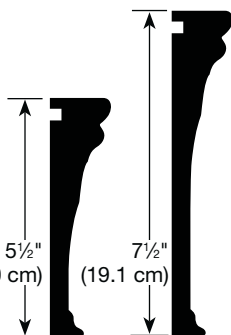

Regal Wood—Inside Mount



Noble Wood—Outside Mount

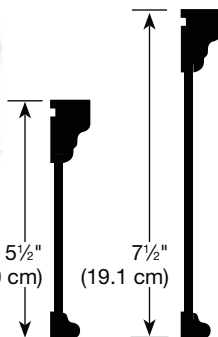

Noble Wood—Inside Mount



Symphony Wood—Outside Mount



Symphony Wood—Inside Mount



### Regal Wood Cornice

Available in either a 5½" (14.0 cm) or 7½" (19.1 cm) size and in all colors listed below.

### Noble Wood Cornice

Available in either a 5½" (14.0 cm) or 7½" (19.1 cm) size and in all colors listed below.

#### Paint Colors

Angora . . . . .	1052
Antique White . . . . .	1026
Base White . . . . .	1051
Crisp White . . . . .	1712
Custom Color* . . . . .	CUSP
Dover White . . . . .	1683
Dovetail . . . . .	1839
Grey Beige . . . . .	1817
Medium Grey . . . . .	1841
Pearl . . . . .	1840
Snow White . . . . .	1850
Snowflake . . . . .	1603
Stepping Stone . . . . .	1889
Stucco . . . . .	1963

#### Stain Colors

Allspice . . . . .	1821	Honey Maple . . . . .	1013
Cappuccino . . . . .	1546	Natural . . . . .	1007
Cherry Wood . . . . .	1014	Roasted Chestnut . . . . .	1849
Cognac . . . . .	1465	Saddle Brown . . . . .	1694
Custom Color* . . . . .	CUSS	Sienna . . . . .	1685
Dark Cherry . . . . .	1316	Timeless Grey . . . . .	1847
Dark Walnut . . . . .	1641	True Taupe . . . . .	1848
Espresso . . . . .	1716	Truffle . . . . .	1054
Golden Oak . . . . .	1030	Unfinished . . . . .	1717
Harbor Grey . . . . .	1761	Walnut . . . . .	1012
Henna . . . . .	1949	Wheat . . . . .	1710
Homestead Oak . . . . .	1943		

### Symphony Wood Cornice

Available in 4½" (11.5 cm) size and in all colors listed below.

#### Paint Colors

Angora . . . . .	1052
Antique White . . . . .	1026
Base White . . . . .	1051
Crisp White . . . . .	1712
Custom Color* . . . . .	CUSP
Dover White . . . . .	1683
Dovetail . . . . .	1839
Grey Beige . . . . .	1817
Medium Grey . . . . .	1841
Medium Grey Sandblast† . . . . .	SB841
Pearl . . . . .	1840
Snow White . . . . .	1850
Snowflake . . . . .	1603
Snowflake Sandblast† . . . . .	SB603
Stepping Stone . . . . .	1889
Stucco . . . . .	1963

#### Stain Colors

Allspice . . . . .	1821	Honey Maple . . . . .	1013
Cappuccino . . . . .	1546	Knotty Pine . . . . .	1515
Cherry Wood . . . . .	1014	Natural . . . . .	1007
Cognac . . . . .	1465	Roasted Chestnut . . . . .	1849
Custom Color* . . . . .	CUSS	Saddle Brown . . . . .	1694
Dark Cherry . . . . .	1316	Sienna . . . . .	1685
Dark Walnut . . . . .	1641	Timeless Grey . . . . .	1847
Espresso . . . . .	1716	True Taupe . . . . .	1848
Golden Oak . . . . .	1030	Truffle . . . . .	1054
Harbor Grey . . . . .	1761	Unfinished . . . . .	1717
Henna . . . . .	1949	Walnut . . . . .	1012
Homestead Oak . . . . .	1943	Wheat . . . . .	1710

\*Custom color: see pricing section for net surcharge per color.

†Keystones are not available in sandblast finish, but will come in matching paint color in a smooth finish.

# Options

## Wood Valances

- Painted and stained valances crafted from premium North American hardwood
- Fine furniture-quality finish
- Returns for inside mount must be specified
- Inside mount has straight cut ends, no returns
- Outside mount has mitered corners and returns
- Custom returns may be ordered for both inside and outside mount up to 8" (20.4 cm); minimum return is ½" (1.3 cm)
- Valances only available on bay and corner windows if bay and corner application is available on entire product line selected
- Single side return available; opposite end will be straight cut

**NOTE:** Wood valance will be shipped separate from blinds. Manufacturer recommends installing blind and valance at the same time.

Classic—Outside Mount



Classic—Inside Mount

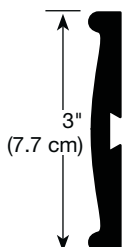

### Classic Valance

3" (7.7 cm) available in all colors at bottom of page.  
2½" (6.4 cm) available in barnwood; not available with keystones.

#### Barnwood Colors

Medium Pewter . . . 1049  
Windswept. . . . . 1072

Legacy—Outside Mount



Legacy—Inside Mount



### 3½" (8.9 cm) Legacy Valance

Available in all colors at bottom of page.  
Available in distressed wood and authentic hardwood; not available with keystones.

#### Distressed Wood Colors

Smoky Coal . . . . . 1572  
Twig. . . . . 1070

#### Authentic Hardwood Colors

Cherry . . . . . C007  
Maple. . . . . M007  
Walnut . . . . . W007

Craftsman—Outside Mount



Craftsman—Inside Mount

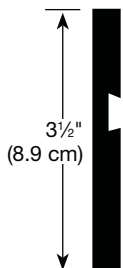

### 3½" (8.9 cm) Craftsman Valance

Available in all colors at bottom of page.

Symphony—Outside Mount



Symphony—Inside Mount

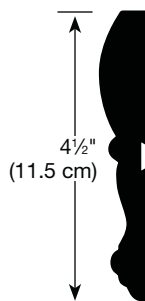

### 4½" (11.5 cm) Symphony Wood Valance

Available in all colors at bottom of page.

#### Paint Colors

Angora . . . . . 1052	Medium Grey . . . . . 1841
Antique White . . . . . 1026	Medium Grey Sandblast† .SB841
Base White . . . . . 1051	Pearl . . . . . 1840
Crisp White . . . . . 1712	Snow White . . . . . 1850
Custom Color*. . . . . CUSP	Snowflake . . . . . 1603
Dover White. . . . . 1683	Snowflake Sandblast† . SB603
Dovetail . . . . . 1839	Stepping Stone . . . . . 1889
Grey Beige. . . . . 1817	Stucco. . . . . 1963

#### Stain Colors

Allspice . . . . . 1821	Natural. . . . . 1007
Cappuccino . . . . . 1546	Roasted Chestnut. . . . . 1849
Cherry Wood. . . . . 1014	Rustic Cognac. . . . . R1465
Cognac . . . . . 1465	Rustic Golden Oak . . . R1030
Custom Color*. . . . . CUSS	Rustic Harbor Grey . . . R1761
Dark Cherry . . . . . 1316	Saddle Brown . . . . . 1694
Dark Walnut. . . . . 1641	Sienna . . . . . 1685
Espresso . . . . . 1716	Timeless Grey . . . . . 1847
Golden Oak . . . . . 1030	True Taupe . . . . . 1848
Harbor Grey. . . . . 1761	Truffle . . . . . 1054
Henna . . . . . 1949	Unfinished . . . . . 1717
Homestead Oak . . . . . 1943	Walnut . . . . . 1012
Honey Maple. . . . . 1013	Wheat . . . . . 1710
Knotty Pine . . . . . 1515	

\*Custom color: see pricing section for net surcharge per color.

†Keystones are not available in sandblast finish, but will come in matching paint color in a smooth finish.

# Options

## Composite and Faux Wood Valances

- Composite and faux wood valance options are ideal for a finished look in a high humidity room
- Includes mounting hardware for specified product use
- Returns for inside mount must be specified
- Inside mount has straight cut ends, no returns
- Outside mount has mitered corners and returns
- Custom returns may be ordered for both inside and outside mount up to 8" (20.4 cm); minimum return is ½" (1.3 cm)
- Valances only available on bay and corner windows if bay and corner application is available on entire product line selected
- Single side return available; opposite end will be straight cut
- Not available with keystones

**NOTE:** Composite and faux wood valances will be shipped separate from blinds. Manufacturer recommends installing blind and valance at the same time.

Classic—Outside Mount



Classic—Inside Mount



### 3" (7.7 cm) Classic Composite and Faux Wood Valance

Add a classic touch to any room.

Available in all colors listed at the bottom of page.

Majestic—Outside Mount



Majestic—Inside Mount

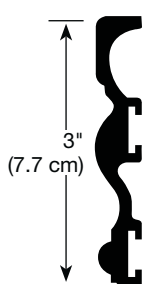

### 3" (7.7 cm) Majestic Composite and Faux Wood Valance

Add a decorative element to the window.

Available in all colors listed at the bottom of page.

#### Composite Colors

Antique White . . . . .	2026
Base White . . . . .	2051
Creamy White . . . . .	2729
Seattle Grey . . . . .	2174
Silk White . . . . .	2922

#### Premium Faux Wood Colors

Cognac . . . . .	2465
Dark Cherry . . . . .	2316
Golden Oak . . . . .	2030
Honey Maple . . . . .	2013
Misty Grey . . . . .	2230
Moonshine . . . . .	2738
Morel . . . . .	2706
Natural . . . . .	2007
Phantom . . . . .	2707
Saddle Brown . . . . .	2694
Sienna . . . . .	2685
Walnut . . . . .	2012
Wheat . . . . .	2710

#### Faux Wood Colors

Almond . . . . .	5724
Buttermilk . . . . .	5078
Buttermilk Textured† . . . . .	5953
Coconut . . . . .	5630
Coconut Textured† . . . . .	5299
Marshmallow . . . . .	5742
Milky Way . . . . .	5058
Milky Way Textured† . . . . .	5304
Seattle Grey . . . . .	5174
White . . . . .	5035
White Textured† . . . . .	5951

†Classic valance will be textured. Majestic valance will be color coordinated in a smooth finish.

# Options

## Decorative Keystones



- Decorative keystones are required on wood cornices and valances that require splicing
- The keystones will be equally spaced unless special splice locations are requested at time of order
- Keystones can be requested on wood cornices without a splice at time of order
  - Minimum width with a keystone: 12" (30.5 cm)
  - Maximum number of keystones: 3
- Keystones will be stained or painted to match the valance or cornice ordered as standard; optional different color selection available
- Keystones not available on authentic hardwood, barnwood, distressed wood, in sandblast finish, composite, or faux wood valances
- All inside mount applications will have a slight light gap at the top of the cornice or valance when installed with a keystone
- Keystones cannot be added to existing valances or symphony cornices because the keystones require splicing at the time of order

## Splicing Requirements

Profile	Number of Sections	Number of Keystones	No Returns		With Returns (inside dimensions)	
			Minimum inches (cm)	Maximum inches (cm)	Minimum inches (cm)	Maximum inches (cm)
2½" (6.4 cm) Classic Barnwood Valance*	1	0	8 (20.4)	100¼ (254.7)	8 (20.4)	98¾ (249.9)
3" (7.7 cm) Classic Wood Valance	2	1	100⅞ (254.8)	200½ (509.3)	98⅞ (250.1)	198⅞ (504.6)
3½" (8.9 cm) Craftsman Wood Valance	3	2	200⅞ (509.5)	300¾ (764.0)	198⅞ (504.7)	298⅞ (759.2)
3½" (8.9 cm) Legacy Wood Valance	1	0	8 (20.4)	95 (241.3)	8 (20.4)	95 (241.3)
4½" (11.5 cm) Symphony Cornice	2	1	95⅞ (241.5)	190⅞ (483.6)	95⅞ (241.5)	190⅞ (483.6)
	3	2	190⅞ (483.7)	285¼ (725.8)	190⅞ (483.7)	285¼ (725.8)
	4	3	285⅞ (726.0)	300 (762.0)	285⅞ (726.0)	300 (762.0)
	1	0	8 (20.4)	94 (238.8)	8 (20.4)	92½ (234.0)
5½" (14.0 cm) Noble Cornice	2	1	94⅞ (239.0)	187⅞ (475.2)	92⅞ (234.2)	185⅞ (470.4)
	3	2	187⅞ (475.3)	280⅞ (711.6)	185¼ (470.6)	278¼ (706.8)
	4	3	280⅞ (711.7)	366 (929.7)	278⅞ (707.0)	366 (929.7)
	1	0	8 (20.4)	94 (238.8)	8 (20.4)	91⅞ (232.1)
7½" (19.1 cm) Noble Cornice	2	1	94⅞ (239.0)	186⅞ (474.2)	91⅞ (232.3)	184⅞ (467.6)
	3	2	186⅞ (474.4)	279⅞ (709.7)	184⅞ (467.7)	276¼ (703.0)
	4	3	279⅞ (709.8)	366 (929.7)	276⅞ (703.2)	366 (929.7)
	1	0	8 (20.4)	94 (238.8)	8 (20.4)	91⅞ (231.5)
5½" (14.0 cm) Regal Cornice	2	1	94⅞ (239.0)	186⅞ (473.9)	91⅞ (231.7)	183⅞ (466.6)
	3	2	186⅞ (474.1)	279⅞ (709.0)	183¼ (466.8)	276¼ (701.7)
	4	3	279⅞ (709.2)	366 (929.7)	276⅞ (701.9)	366 (929.7)
	1	0	8 (20.4)	94 (238.8)	8 (20.4)	90 (228.6)
7½" (19.1 cm) Regal Cornice	2	1	94⅞ (239.0)	186 (472.5)	90⅞ (228.8)	182 (462.3)
	3	2	186⅞ (472.6)	278 (706.2)	182⅞ (462.5)	274 (696.0)
	4	3	278⅞ (706.3)	366 (929.7)	274⅞ (696.2)	366 (929.7)

\*Keystones not available.

### Outside Mount

- Wood cornices and valances requiring a splice will include a keystone (see chart above for details)

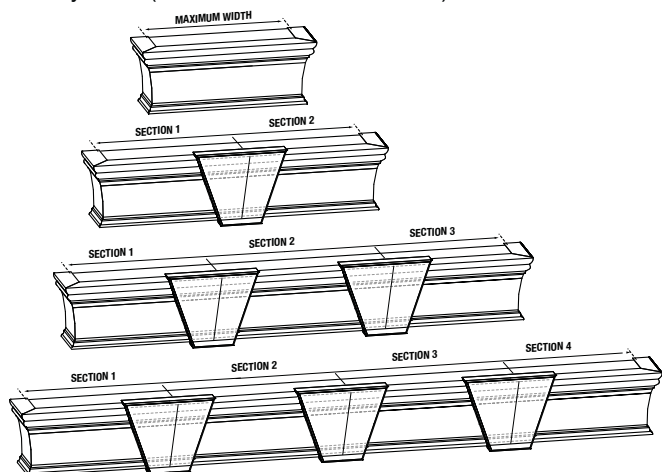

### Inside Mount

- Wood valances 100¼" (254.7 cm) or wider and cornices 94" (238.8 cm) or wider will require a keystone

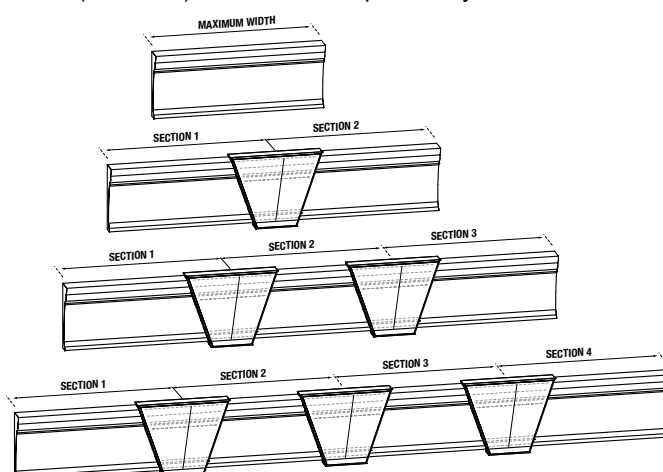



# Options

## Palladian Window Shelf

A wood shelf or header that may be installed in applications lacking a window frame for mounting a blind. Blinds or other window treatments may be installed either above or below the shelf.

- Created from premium North American hardwood
- Use with any Graber® blind or shade
- Ideal for arch top windows
- Use as a divider for long windows
- Easy mounting brackets included
- Available in all paints and stains to coordinate with Graber Wood Blinds, as well as unfinished or with custom color
- Available in depths from 4" (10.2 cm) to as narrow as 2" (5.1 cm)

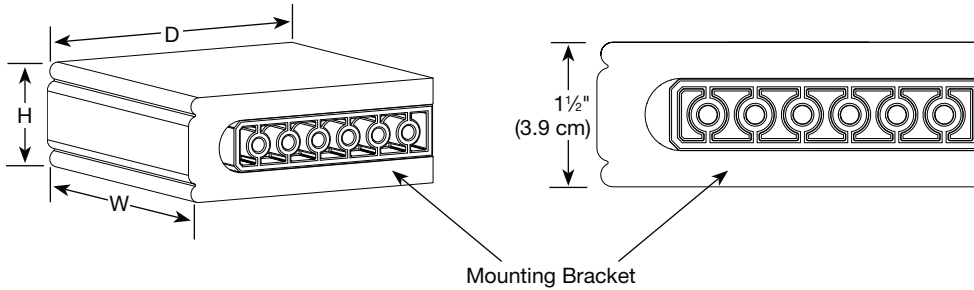



Paint Colors		Stain Colors	
Angora . . . . . 1052	Grey Beige . . . . . 1817	Allspice . . . . . 1821	Honey Maple . . . . . 1013
Antique White . . . . . 1026	Medium Grey . . . . . 1841	Cappuccino . . . . . 1546	Natural . . . . . 1007
Base White . . . . . 1051	Pearl . . . . . 1840	Cherry Wood . . . . . 1014	Roasted Chestnut . . . . . 1849
Crisp White . . . . . 1712	Snow White . . . . . 1850	Cognac . . . . . 1465	Saddle Brown . . . . . 1694
Custom Color* . . . . . CUSP	Snowflake . . . . . 1603	Custom Color* . . . . . CUSS	Sienna . . . . . 1685
Dover White . . . . . 1683	Stepping Stone . . . . . 1889	Dark Cherry . . . . . 1316	Timeless Grey . . . . . 1847
Dovetail . . . . . 1839	Stucco . . . . . 1963	Dark Walnut . . . . . 1641	True Taupe . . . . . 1848
		Espresso . . . . . 1716	Truffle . . . . . 1054
		Golden Oak . . . . . 1030	Unfinished . . . . . 1717
		Harbor Grey . . . . . 1761	Walnut . . . . . 1012
		Henna . . . . . 1949	Wheat . . . . . 1710
		Homestead Oak . . . . . 1943	

\*Custom color: see pricing section for net surcharge per color.

# General Information

## Valance Returns: Horizontal Blinds

Returns for inside mount must be specified.

Valance Type	Blind Type	Maximum Continuous Width*		Control Type	Standard Valance Returns inches (cm)	Full Recess Depth inches (cm)
		Inside Mount No Returns inches (cm)	Inside Mount with Returns inches (cm)			
<b>2½" (6.4 cm) Classic Valance</b>  Valance Returns ½" (1.3 cm) to 1" (2.6 cm): glued 1⅛" (2.7 cm) to 4⅝" (11.8 cm): optional glued 4⅞" (12.0 cm) and greater: not glued	2" (5.1 cm) Barnwood <sup>^</sup>	100¼ (254.7)	98⅝ (249.9)	Cord tilt	2⅝ (7.4)	3¼ (8.3)
				Wand tilt	3⅞ (9.1)	3⅞ (9.9)
				Cordless wand tilt	3⅞ (8.6)	3¼ (9.6)
				Cordless cord tilt	2¾ (7.0)	3⅞ (7.8)
<b>3" (7.7 cm) Classic Valance</b>  Valance Returns ½" (1.3 cm) to 1" (2.6 cm): glued 1⅛" (2.7 cm) to 4⅝" (11.8 cm): optional glued 4⅞" (12.0 cm) and greater: not glued	1" (2.6 cm) Wood	100¼ (254.7)	98⅝ (249.9)	Wand tilt	2⅞ (5.3)	2⅝ (6.1)
	2" (5.1 cm) Wood 2" (5.1 cm) Elite Wood 2" (5.1 cm) Aluminum <sup>†</sup> 2" (5.1 cm) Vinyl <sup>†</sup>	100¼ (254.7)	98⅝ (249.9)	Cord tilt	2⅝ (7.4)	3¼ (8.3)
				Wand tilt	3⅞ (9.1)	3⅞ (9.9)
				Cordless wand tilt	3⅞ (8.6)	3¼ (9.6)
				Cordless cord tilt	2¾ (7.0)	3⅞ (7.8)
	2⅝" (6.1 cm) Wood 2⅝" (6.1 cm) Elite Wood	100¼ (254.7)	98⅝ (249.9)	Cord tilt	3¼ (9.6)	4⅞ (10.4)
				Wand tilt	3¼ (9.6)	4⅞ (10.4)
	Cordless wand tilt	100¼ (254.7)	98⅝ (249.9)	Cordless wand tilt	3⅞ (9.1)	3⅞ (10.1)
				Cordless cord tilt	3⅞ (9.1)	3⅞ (10.1)
	Wood Verticals	100¼ (254.7)	98⅝ (249.9)	N/A	5½ (14.0)	5⅞ (14.8)
	2" (5.1 cm) Composite <sup>^</sup>	106⅞ (270.9)	105⅝ (267.7)	Cord tilt	2⅝ (7.4)	3¼ (8.3)
				Wand tilt	3⅞ (9.1)	3⅞ (9.9)
				Cordless wand tilt	3⅞ (8.6)	3¼ (9.6)
				Cordless cord tilt	2¾ (7.0)	3⅞ (7.8)
Cord tilt				3⅞ (10.1)	4¼ (10.8)	
Wand tilt				3⅞ (10.1)	4¼ (10.8)	
Cordless wand tilt				3¼ (9.6)	4⅞ (10.5)	
Cordless cord tilt				3¼ (9.6)	4⅞ (10.5)	
2" (5.1 cm) Premium Faux Wood <sup>^</sup> 2" (5.1 cm) Faux Wood <sup>^</sup>	106⅞ (270.9)	105⅝ (267.7)	Cord tilt	2⅝ (7.4)	3¼ (8.3)	
			Wand tilt	3⅞ (9.1)	3⅞ (9.9)	
Cordless wand tilt	106⅞ (270.9)	105⅝ (267.7)	Cordless wand tilt	3⅞ (8.6)	3¼ (9.6)	
			Cordless cord tilt	2¾ (7.0)	3⅞ (7.8)	
2½" (6.4 cm) Premium Faux Wood <sup>^</sup> 2½" (6.4 cm) Faux Wood <sup>^</sup>	106⅞ (270.9)	105⅝ (267.7)	Cord tilt	3⅞ (10.1)	4¼ (10.8)	
			Wand tilt	3⅞ (10.1)	4¼ (10.8)	
Cordless wand tilt	106⅞ (270.9)	105⅝ (267.7)	Cordless wand tilt	3¼ (9.6)	4⅞ (10.5)	
			Cordless cord tilt	3¼ (9.6)	4⅞ (10.5)	
<b>3" (7.7 cm) Majestic Valance</b>  Valance Returns ½" (1.3 cm) to 1" (2.6 cm): glued 1⅛" (2.7 cm) to 4⅝" (11.8 cm): optional glued 4⅞" (12.0 cm) and greater: not glued	2" (5.1 cm) Composite <sup>^</sup>	106⅞ (270.9)	105⅝ (267.7)	Cord tilt	2⅝ (7.4)	3⅞ (8.6)
				Wand tilt	3⅞ (9.1)	4⅞ (10.4)
				Cordless wand tilt	3⅞ (8.6)	3⅞ (9.9)
				Cordless cord tilt	2¾ (7.0)	3⅞ (8.1)
	2½" (6.4 cm) Composite <sup>^</sup>	106⅞ (270.9)	105⅝ (267.7)	Cord tilt	3⅞ (10.1)	4⅞ (11.3)
				Wand tilt	3⅞ (10.1)	4⅞ (11.3)
				Cordless wand tilt	3¼ (9.6)	4¼ (10.8)
				Cordless cord tilt	3¼ (9.6)	4¼ (10.8)
2" (5.1 cm) Premium Faux Wood <sup>^</sup> 2" (5.1 cm) Faux Wood <sup>^</sup>	106⅞ (270.9)	105⅝ (267.7)	Cord tilt	2⅝ (7.4)	3⅞ (8.6)	
			Wand tilt	3⅞ (9.1)	4⅞ (10.4)	
Cordless wand tilt	106⅞ (270.9)	105⅝ (267.7)	Cordless wand tilt	3⅞ (8.6)	3⅞ (9.9)	
			Cordless cord tilt	2¾ (7.0)	3⅞ (8.1)	
2½" (6.4 cm) Premium Faux Wood <sup>^</sup> 2½" (6.4 cm) Faux Wood <sup>^</sup>	106⅞ (270.9)	105⅝ (267.7)	Cord tilt	3⅞ (10.1)	4⅞ (11.3)	
			Wand tilt	3⅞ (10.1)	4⅞ (11.3)	
Cordless wand tilt	106⅞ (270.9)	105⅝ (267.7)	Cordless wand tilt	3¼ (9.6)	4¼ (10.8)	
			Cordless cord tilt	3¼ (9.6)	4¼ (10.8)	

\*Continuous valances wider than sizes shown above will have two or more sections spliced together with a keystone. Maximum width for spliced valances is 300¼" (764.0 cm).



<sup>^</sup>Keystones not available.

<sup>†</sup>Cordless lift not available.

# General Information

## Valance Returns: Horizontal Blinds

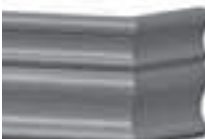
Returns for inside mount must be specified.

Valance Type	Blind Type	Maximum Continuous Width*		Control Type	Standard Valance Returns inches (cm)	Full Recess Depth inches (cm)
		Inside Mount No Returns inches (cm)	Inside Mount with Returns inches (cm)			
<b>3½" (8.9 cm) Craftsman Valance</b>  Valance Returns ½" (1.3 cm) to 1" (2.6 cm): glued 1⅛" (2.7 cm) to 4⅝" (11.8 cm): optional glued 4⅞" (12.0 cm) and greater: not glued	1" (2.6 cm) Wood	100¼ (254.7)	98⅞ (249.9)	Wand tilt	2⅛ (5.3)	2⅝ (6.1)
	2" (5.1 cm) Wood 2" (5.1 cm) Elite Wood 2" (5.1 cm) Aluminum† 2" (5.1 cm) Vinyl†	100¼ (254.7)	98⅞ (249.9)	Cord tilt Wand tilt Cordless wand tilt Cordless cord tilt	2⅞ (7.4) 3⅞ (9.1) 3⅞ (8.6) 2¾ (7.0)	3¼ (8.3) 3⅞ (9.9) 3¼ (9.6) 3⅞ (7.8)
	2⅝" (6.1 cm) Wood 2⅝" (6.1 cm) Elite Wood	100¼ (254.7)	98⅞ (249.9)	Cord tilt Wand tilt Cordless wand tilt Cordless cord tilt	3¼ (9.6) 3¼ (9.6) 3⅞ (9.1) 3⅞ (9.1)	4⅞ (10.4) 4⅞ (10.4) 3⅞ (10.1) 3⅞ (10.1)
	Wood Verticals	100¼ (254.7)	98⅞ (249.9)	N/A	5½ (14.0)	5⅞ (14.8)
<b>3½" (8.9 cm) Legacy Valance</b>  Valance Returns ½" (1.3 cm) to 1" (2.6 cm): glued 1⅛" (2.7 cm) to 4⅝" (11.8 cm): optional glued 4⅞" (12.0 cm) and greater: not glued	1" (2.6 cm) Wood	100¼ (254.7)	98⅞ (249.9)	Wand tilt	2⅛ (5.3)	2⅞ (6.2)
	2" (5.1 cm) Wood 2" (5.1 cm) Elite Wood 2" (5.1 cm) Aluminum† 2" (5.1 cm) Vinyl†	100¼ (254.7)	98⅞ (249.9)	Cord tilt Wand tilt Cordless wand tilt Cordless cord tilt	2⅞ (7.4) 3⅞ (9.1) 3⅞ (8.6) 2¾ (7.0)	3⅝ (8.5) 4 (10.2) 3⅞ (9.7) 3⅞ (8.0)
	2" (5.1 cm) Distressed Wood^ 2" (5.1 cm) Elite Authentic Hardwood^	100¼ (254.7)	98⅞ (249.9)	Cord tilt Wand tilt Cordless wand tilt Cordless cord tilt	2⅞ (7.4) 3⅞ (9.1) 3⅞ (8.6) 2¾ (7.0)	3⅝ (8.5) 4 (10.2) 3⅞ (9.7) 3⅞ (8.0)
	2⅝" (6.1 cm) Wood 2⅝" (6.1 cm) Elite Wood	100¼ (254.7)	98⅞ (249.9)	Cord tilt Wand tilt Cordless wand tilt Cordless cord tilt	3¼ (9.6) 3¼ (9.6) 3⅞ (9.1) 3⅞ (9.1)	4⅞ (10.7) 4⅞ (10.7) 4⅞ (10.4) 4⅞ (10.4)
	Wood Verticals	100¼ (254.7)	98⅞ (249.9)	N/A	5½ (14.0)	5⅞ (15)
<b>4½" (11.5 cm) Symphony Valance</b>  Valance Returns ½" (1.3 cm) to 1" (2.6 cm): glued 1⅛" (2.7 cm) to 4⅝" (11.8 cm): optional glued 4⅞" (12.0 cm) and greater: not glued	1" (2.6 cm) Wood	100¼ (254.7)	98⅞ (249.9)	Wand tilt	2⅛ (5.3)	2⅞ (7.2)
	2" (5.1 cm) Wood 2" (5.1 cm) Elite Wood 2" (5.1 cm) Aluminum† 2" (5.1 cm) Vinyl†	100¼ (254.7)	98⅞ (249.9)	Cord tilt Wand tilt Cordless wand tilt Cordless cord tilt	2⅞ (7.4) 3⅞ (9.1) 3⅞ (8.6) 2¾ (7.0)	3⅞ (9.3) 4⅞ (11.0) 4⅞ (10.5) 3½ (8.9)
	2⅝" (6.1 cm) Wood 2⅝" (6.1 cm) Elite Wood	100¼ (254.7)	98⅞ (249.9)	Cord tilt Wand tilt Cordless wand tilt Cordless cord tilt	3¼ (9.6) 3¼ (9.6) 3⅞ (9.1) 3⅞ (9.1)	4½ (11.5) 4½ (11.5) 4⅞ (11.0) 4⅞ (11.0)
	Wood Verticals	100¼ (254.7)	98⅞ (249.9)	N/A	5½ (14.0)	6¼ (15.9)

\*Continuous valances wider than sizes shown above will have two or more sections spliced together with a keystone. Maximum width for spliced valances is 300¼" (764.0 cm).

^Keystones not available.

†Cordless lift not available.

## General Information

### Wood Valance Returns

Valance Type	Control Type	Standard Return Inside Width inches (cm)	Full Recess Depth inches (cm)
<b>1" (2.6 cm) Wood Horizontal Blinds</b>			
3" (7.7 cm) Classic Wood Valance	Wand tilt	2 <sup>1</sup> / <sub>16</sub> (5.3)	2 <sup>5</sup> / <sub>16</sub> (6.1)
3 <sup>1</sup> / <sub>2</sub> " (8.9 cm) Craftsman Wood Valance	Wand tilt	2 <sup>1</sup> / <sub>16</sub> (5.3)	2 <sup>5</sup> / <sub>16</sub> (6.1)
3 <sup>1</sup> / <sub>2</sub> " (8.9 cm) Legacy Wood Valance	Wand tilt	2 <sup>1</sup> / <sub>16</sub> (5.3)	2 <sup>7</sup> / <sub>16</sub> (6.2)
4 <sup>1</sup> / <sub>2</sub> " (11.5 cm) Symphony Wood Valance	Wand tilt	2 <sup>1</sup> / <sub>16</sub> (5.3)	2 <sup>1</sup> / <sub>16</sub> (7.2)
<b>2" (5.1 cm) Wood, Aluminum, and Vinyl Horizontal Blinds</b>			
2 <sup>1</sup> / <sub>2</sub> " (6.4 cm) Classic Barnwood Valance <sup>†</sup>	Cord tilt	2 <sup>7</sup> / <sub>8</sub> (7.4)	3 <sup>1</sup> / <sub>4</sub> (8.3)
	Wand tilt	3 <sup>3</sup> / <sub>16</sub> (9.1)	3 <sup>7</sup> / <sub>8</sub> (9.9)
	Cordless wand tilt	3 <sup>3</sup> / <sub>8</sub> (8.6)	3 <sup>3</sup> / <sub>4</sub> (9.6)
	Cordless cord tilt	2 <sup>3</sup> / <sub>4</sub> (7.0)	3 <sup>1</sup> / <sub>16</sub> (7.8)
3" (7.7 cm) Classic Wood Valance*	Cord tilt	2 <sup>7</sup> / <sub>8</sub> (7.4)	3 <sup>1</sup> / <sub>4</sub> (8.3)
	Wand tilt	3 <sup>3</sup> / <sub>16</sub> (9.1)	3 <sup>7</sup> / <sub>8</sub> (9.9)
	Cordless wand tilt	3 <sup>3</sup> / <sub>8</sub> (8.6)	3 <sup>3</sup> / <sub>4</sub> (9.6)
	Cordless cord tilt	2 <sup>3</sup> / <sub>4</sub> (7.0)	3 <sup>1</sup> / <sub>16</sub> (7.8)
3 <sup>1</sup> / <sub>2</sub> " (8.9 cm) Craftsman Wood Valance*	Cord tilt	2 <sup>7</sup> / <sub>8</sub> (7.4)	3 <sup>1</sup> / <sub>4</sub> (8.3)
	Wand tilt	3 <sup>3</sup> / <sub>16</sub> (9.1)	3 <sup>7</sup> / <sub>8</sub> (9.9)
	Cordless wand tilt	3 <sup>3</sup> / <sub>8</sub> (8.6)	3 <sup>3</sup> / <sub>4</sub> (9.6)
	Cordless cord tilt	2 <sup>3</sup> / <sub>4</sub> (7.0)	3 <sup>1</sup> / <sub>16</sub> (7.8)
3 <sup>1</sup> / <sub>2</sub> " (8.9 cm) Legacy Wood Valance*	Cord tilt	2 <sup>7</sup> / <sub>8</sub> (7.4)	3 <sup>3</sup> / <sub>16</sub> (8.5)
	Wand tilt	3 <sup>3</sup> / <sub>16</sub> (9.1)	4 (10.2)
	Cordless wand tilt	3 <sup>3</sup> / <sub>8</sub> (8.6)	3 <sup>1</sup> / <sub>16</sub> (9.7)
	Cordless cord tilt	2 <sup>3</sup> / <sub>4</sub> (7.0)	3 <sup>1</sup> / <sub>8</sub> (8.0)
4 <sup>1</sup> / <sub>2</sub> " (11.5 cm) Symphony Wood Valance*	Cord tilt	2 <sup>7</sup> / <sub>8</sub> (7.4)	3 <sup>5</sup> / <sub>8</sub> (9.3)
	Wand tilt	3 <sup>3</sup> / <sub>16</sub> (9.1)	4 <sup>7</sup> / <sub>16</sub> (11.0)
	Cordless wand tilt	3 <sup>3</sup> / <sub>8</sub> (8.6)	4 <sup>1</sup> / <sub>8</sub> (10.5)
	Cordless cord tilt	2 <sup>3</sup> / <sub>4</sub> (7.0)	3 <sup>1</sup> / <sub>2</sub> (8.9)
<b>2<sup>3</sup>/<sub>8</sub>" (6.1 cm) Wood Horizontal Blinds</b>			
3" (7.7 cm) Classic Wood Valance	Cord tilt	3 <sup>3</sup> / <sub>4</sub> (9.6)	4 <sup>1</sup> / <sub>16</sub> (10.4)
	Wand tilt	3 <sup>3</sup> / <sub>4</sub> (9.6)	4 <sup>1</sup> / <sub>16</sub> (10.4)
	Cordless wand tilt	3 <sup>5</sup> / <sub>16</sub> (9.1)	3 <sup>15</sup> / <sub>16</sub> (10.1)
	Cordless cord tilt	3 <sup>3</sup> / <sub>16</sub> (9.1)	3 <sup>15</sup> / <sub>16</sub> (10.1)
3 <sup>1</sup> / <sub>2</sub> " (8.9 cm) Craftsman Wood Valance	Cord tilt	3 <sup>3</sup> / <sub>4</sub> (9.6)	4 <sup>1</sup> / <sub>16</sub> (10.4)
	Wand tilt	3 <sup>3</sup> / <sub>4</sub> (9.6)	4 <sup>1</sup> / <sub>16</sub> (10.4)
	Cordless wand tilt	3 <sup>5</sup> / <sub>16</sub> (9.1)	3 <sup>15</sup> / <sub>16</sub> (10.1)
	Cordless cord tilt	3 <sup>3</sup> / <sub>16</sub> (9.1)	3 <sup>15</sup> / <sub>16</sub> (10.1)
3 <sup>1</sup> / <sub>2</sub> " (8.9 cm) Legacy Wood Valance	Cord tilt	3 <sup>3</sup> / <sub>4</sub> (9.6)	4 <sup>3</sup> / <sub>16</sub> (10.7)
	Wand tilt	3 <sup>3</sup> / <sub>4</sub> (9.6)	4 <sup>3</sup> / <sub>16</sub> (10.7)
	Cordless wand tilt	3 <sup>5</sup> / <sub>16</sub> (9.1)	4 <sup>1</sup> / <sub>16</sub> (10.4)
	Cordless cord tilt	3 <sup>3</sup> / <sub>16</sub> (9.1)	4 <sup>1</sup> / <sub>16</sub> (10.4)
4 <sup>1</sup> / <sub>2</sub> " (11.5 cm) Symphony Wood Valance	Cord tilt	3 <sup>3</sup> / <sub>4</sub> (9.6)	4 <sup>1</sup> / <sub>2</sub> (11.5)
	Wand tilt	3 <sup>3</sup> / <sub>4</sub> (9.6)	4 <sup>1</sup> / <sub>2</sub> (11.5)
	Cordless wand tilt	3 <sup>5</sup> / <sub>16</sub> (9.1)	4 <sup>3</sup> / <sub>16</sub> (11.0)
	Cordless cord tilt	3 <sup>3</sup> / <sub>16</sub> (9.1)	4 <sup>3</sup> / <sub>16</sub> (11.0)

\*Cordless lift not available with 2" (5.1 cm) aluminum or vinyl blinds.

†Only available with 2" (5.1 cm) barnwood blinds.

**NOTE:** Minimum return width is 1/2" (1.3 cm); maximum return width is 8" (20.4 cm). Valance returns 1/2" (1.3 cm) to 1" (2.6 cm) will be glued, 1 1/16" (2.7 cm) to 4 5/16" (11.8 cm) will be optional glued, 4 11/16" (12.0 cm) and greater cannot be glued.

Valances only available on bay or corner windows if bay or corner application is available on entire product line selected. See price list of product selected for measuring instructions. If the valance is to be used alone (no product selected), the return width must be specified at the time of the order.

## General Information

Wood Valance Returns			
Valance Type	Control Type	Standard Return Inside Width inches (cm)	Full Recess Depth inches (cm)
<b>Artisan Fabric Roman Shades</b>			
3" (7.7 cm) Classic Wood Valance	Cord lift	4 <sup>1</sup> / <sub>8</sub> (10.5)	4 <sup>3</sup> / <sub>8</sub> (11.2)
	Other lift types	4 <sup>7</sup> / <sub>8</sub> (12.4)	5 <sup>1</sup> / <sub>8</sub> (13.2)
3 <sup>1</sup> / <sub>2</sub> " (8.9 cm) Craftsman Wood Valance	Cord lift	4 <sup>1</sup> / <sub>8</sub> (10.5)	4 <sup>3</sup> / <sub>8</sub> (11.2)
	Other lift types	4 <sup>7</sup> / <sub>8</sub> (12.4)	5 <sup>1</sup> / <sub>8</sub> (13.2)
3 <sup>1</sup> / <sub>2</sub> " (8.9 cm) Legacy Wood Valance	Cord lift	4 <sup>1</sup> / <sub>8</sub> (10.5)	4 <sup>1</sup> / <sub>2</sub> (11.5)
	Other lift types	4 <sup>7</sup> / <sub>8</sub> (12.4)	5 <sup>1</sup> / <sub>4</sub> (13.4)
4 <sup>1</sup> / <sub>2</sub> " (11.5 cm) Symphony Wood Valance	Cord lift	4 <sup>1</sup> / <sub>8</sub> (10.5)	4 <sup>7</sup> / <sub>8</sub> (12.4)
	Other lift types	4 <sup>7</sup> / <sub>8</sub> (12.4)	5 <sup>3</sup> / <sub>8</sub> (14.3)
<b>Cellular, Pleated, Fresco Roman, Solar, and Roller Shades</b>			
3" (7.7 cm) Classic Wood Valance	All	3 <sup>3</sup> / <sub>4</sub> (9.6)	4 <sup>1</sup> / <sub>8</sub> (10.4)
3 <sup>1</sup> / <sub>2</sub> " (8.9 cm) Craftsman Wood Valance	All	3 <sup>3</sup> / <sub>4</sub> (9.6)	4 <sup>1</sup> / <sub>8</sub> (10.4)
3 <sup>1</sup> / <sub>2</sub> " (8.9 cm) Legacy Wood Valance	All	3 <sup>3</sup> / <sub>4</sub> (9.6)	4 <sup>1</sup> / <sub>8</sub> (10.5)
4 <sup>1</sup> / <sub>2</sub> " (11.5 cm) Symphony Wood Valance	All	3 <sup>3</sup> / <sub>4</sub> (9.6)	4 <sup>1</sup> / <sub>2</sub> (11.5)
<b>Cellular Shade Vertical Application</b>			
3" (7.7 cm) Classic Wood Valance	All	3 <sup>1</sup> / <sub>8</sub> (8.0)	3 <sup>7</sup> / <sub>8</sub> (8.8)
3 <sup>1</sup> / <sub>2</sub> " (8.9 cm) Craftsman Wood Valance	All	3 <sup>1</sup> / <sub>8</sub> (8.0)	3 <sup>7</sup> / <sub>8</sub> (8.8)
3 <sup>1</sup> / <sub>2</sub> " (8.9 cm) Legacy Wood Valance	All	3 <sup>1</sup> / <sub>8</sub> (8.0)	3 <sup>1</sup> / <sub>2</sub> (8.9)
4 <sup>1</sup> / <sub>2</sub> " (11.5 cm) Symphony Wood Valance	All	3 <sup>1</sup> / <sub>8</sub> (8.0)	3 <sup>3</sup> / <sub>8</sub> (9.9)
<b>Dual Shades</b>			
3" (7.7 cm) Classic Wood Valance*	All	5 <sup>1</sup> / <sub>2</sub> (14.0)	5 <sup>1</sup> / <sub>8</sub> (14.8)
3 <sup>1</sup> / <sub>2</sub> " (8.9 cm) Craftsman Wood Valance*	All	5 <sup>1</sup> / <sub>2</sub> (14.0)	5 <sup>1</sup> / <sub>8</sub> (14.8)
3 <sup>1</sup> / <sub>2</sub> " (8.9 cm) Legacy Wood Valance*	All	5 <sup>1</sup> / <sub>2</sub> (14.0)	5 <sup>7</sup> / <sub>8</sub> (15.0)
4 <sup>1</sup> / <sub>2</sub> " (11.5 cm) Symphony Wood Valance	All	5 <sup>1</sup> / <sub>2</sub> (14.0)	6 <sup>1</sup> / <sub>4</sub> (15.9)
<b>Natural Drapes</b>			
3" (7.7 cm) Classic Wood Valance	All	6 (15.3)	6 <sup>5</sup> / <sub>8</sub> (16.1)
3 <sup>1</sup> / <sub>2</sub> " (8.9 cm) Craftsman Wood Valance	All	6 (15.3)	6 <sup>5</sup> / <sub>8</sub> (16.1)
3 <sup>1</sup> / <sub>2</sub> " (8.9 cm) Legacy Wood Valance	All	6 (15.3)	6 <sup>3</sup> / <sub>8</sub> (16.2)
4 <sup>1</sup> / <sub>2</sub> " (11.5 cm) Symphony Wood Valance	All	6 (15.3)	6 <sup>3</sup> / <sub>4</sub> (17.2)
<b>Natural Shades</b>			
3" (7.7 cm) Classic Wood Valance	All	3 <sup>5</sup> / <sub>8</sub> (9.3)	3 <sup>1</sup> / <sub>8</sub> (10.1)
3 <sup>1</sup> / <sub>2</sub> " (8.9 cm) Craftsman Wood Valance	All	3 <sup>5</sup> / <sub>8</sub> (9.3)	3 <sup>1</sup> / <sub>8</sub> (10.1)
3 <sup>1</sup> / <sub>2</sub> " (8.9 cm) Legacy Wood Valance	All	3 <sup>5</sup> / <sub>8</sub> (9.3)	4 <sup>1</sup> / <sub>8</sub> (10.4)
4 <sup>1</sup> / <sub>2</sub> " (11.5 cm) Symphony Wood Valance	All	3 <sup>5</sup> / <sub>8</sub> (9.3)	4 <sup>3</sup> / <sub>8</sub> (11.2)
<b>Sheer Vertical Blinds</b>			
3" (7.7 cm) Classic Wood Valance	All	6 <sup>1</sup> / <sub>4</sub> (15.9)	6 <sup>5</sup> / <sub>8</sub> (16.7)
3 <sup>1</sup> / <sub>2</sub> " (8.9 cm) Craftsman Wood Valance	All	6 <sup>1</sup> / <sub>4</sub> (15.9)	6 <sup>5</sup> / <sub>8</sub> (16.7)
3 <sup>1</sup> / <sub>2</sub> " (8.9 cm) Legacy Wood Valance	All	6 <sup>1</sup> / <sub>4</sub> (15.9)	6 <sup>3</sup> / <sub>8</sub> (16.9)
4 <sup>1</sup> / <sub>2</sub> " (11.5 cm) Symphony Wood Valance	All	6 <sup>1</sup> / <sub>4</sub> (15.9)	7 (17.8)
<b>Sliding Panels</b>			
3" (7.7 cm) Classic Wood Valance	All	5 (12.7)	5 <sup>5</sup> / <sub>8</sub> (13.5)
3 <sup>1</sup> / <sub>2</sub> " (8.9 cm) Craftsman Wood Valance	All	5 (12.7)	5 <sup>5</sup> / <sub>8</sub> (13.5)
3 <sup>1</sup> / <sub>2</sub> " (8.9 cm) Legacy Wood Valance	All	5 (12.7)	5 <sup>3</sup> / <sub>8</sub> (13.7)
4 <sup>1</sup> / <sub>2</sub> " (11.5 cm) Symphony Wood Valance	All	5 (12.7)	5 <sup>3</sup> / <sub>4</sub> (14.7)

\*Symphony valance recommended for better coverage.

**NOTE:** Minimum return width is 1/2" (1.3 cm); maximum return width is 8" (20.4 cm). Valance returns 1/2" (1.3 cm) to 1" (2.6 cm) will be glued, 1 1/8" (2.7 cm) to 4 5/8" (11.8 cm) will be optional glued, 4 11/16" (12.0 cm) and greater cannot be glued.

Valances only available on bay or corner windows if bay or corner application is available on entire product line selected. See price list of product selected for measuring instructions. If the valance is to be used alone (no product selected), the return width must be specified at the time of the order.

## General Information

### Wood Valance Returns

Valance Type	Control Type	Standard Return Inside Width inches (cm)	Full Recess Depth inches (cm)
<b>Vertical Blinds</b>			
3" (7.7 cm) Classic Wood Valance	All	5½ (14.0)	5 <sup>13</sup> / <sub>16</sub> (14.8)
3½" (8.9 cm) Craftsman Wood Valance	All	5½ (14.0)	5 <sup>13</sup> / <sub>16</sub> (14.8)
3½" (8.9 cm) Legacy Wood Valance	All	5½ (14.0)	5 <sup>7</sup> / <sub>8</sub> (15.0)
4½" (11.5 cm) Symphony Wood Valance	All	5½ (14.0)	6 <sup>1</sup> / <sub>4</sub> (15.9)

**NOTE:** Minimum return width is ½" (1.3 cm); maximum return width is 8" (20.4 cm). Valance returns ½" (1.3 cm) to 1" (2.6 cm) will be glued, 1<sup>1</sup>/<sub>16</sub>" (2.7 cm) to 4<sup>5</sup>/<sub>16</sub>" (11.8 cm) will be optional glued, 4<sup>11</sup>/<sub>16</sub>" (12.0 cm) and greater cannot be glued. Valances only available on bay or corner windows if bay or corner application is available on entire product line selected. See price list of product selected for measuring instructions. If the valance is to be used alone (no product selected), the return width must be specified at the time of the order.

## General Information

### Wood Cornice Returns

Cornice Type	Control Type	Standard Return Inside Width inches (cm)	Full Recess Depth inches (cm)
<b>1" (2.6 cm) Wood Horizontal Blinds</b>			
4½" (11.5 cm) Symphony Wood Cornice	All	3⅞ (9.3)	4⅞ (11.3)
5½" (14.0 cm) Noble Wood Cornice	All	3⅞ (9.3)	4⅞ (11.8)
7½" (19.1 cm) Noble Wood Cornice	All	3⅞ (9.3)	4⅞ (12.6)
5½" (14.0 cm) Regal Wood Cornice	All	3⅞ (9.3)	5⅞ (12.9)
7½" (19.1 cm) Regal Wood Cornice	All	3⅞ (9.3)	5⅞ (14.3)
<b>2" (5.1 cm) Wood, Aluminum, and Vinyl Horizontal Blinds</b>			
4½" (11.5 cm) Symphony Wood Cornice	All	5 (12.7)	5⅞ (14.8)
5½" (14.0 cm) Noble Wood Cornice	All	5 (12.7)	6 (15.3)
7½" (19.1 cm) Noble Wood Cornice	All	5 (12.7)	6⅞ (16.1)
5½" (14.0 cm) Regal Wood Cornice	All	5 (12.7)	6⅞ (16.4)
7½" (19.1 cm) Regal Wood Cornice	All	5 (12.7)	7 (17.8)
<b>2⅜" (6.1 cm) Wood Horizontal Blinds</b>			
4½" (11.5 cm) Symphony Wood Cornice	All	5 (12.7)	5⅞ (14.8)
5½" (14.0 cm) Noble Wood Cornice	All	5 (12.7)	6 (15.3)
7½" (19.1 cm) Noble Wood Cornice	All	5 (12.7)	6⅞ (16.1)
5½" (14.0 cm) Regal Wood Cornice	All	5 (12.7)	6⅞ (16.4)
7½" (19.1 cm) Regal Wood Cornice	All	5 (12.7)	7 (17.8)
<b>Artisan Fabric Roman Shades</b>			
4½" (11.5 cm) Symphony Wood Cornice	Cord lift	4⅞ (10.5)	4⅞ (12.6)
	Other lift types	4⅞ (12.4)	5⅞ (14.5)
5½" (14.0 cm) Noble Wood Cornice	Cord lift	4⅞ (10.5)	5⅞ (13.1)
	Other lift types	4⅞ (12.4)	5⅞ (15.0)
7½" (19.1 cm) Noble Wood Cornice	Cord lift	4⅞ (10.5)	5⅞ (13.9)
	Other lift types	4⅞ (12.4)	6⅞ (15.8)
5½" (14.0 cm) Regal Wood Cornice	Cord lift	4⅞ (10.5)	5⅞ (14.2)
	Other lift types	4⅞ (12.4)	6⅞ (16.1)
7½" (19.1 cm) Regal Wood Cornice	Cord lift	4⅞ (10.5)	6⅞ (15.6)
	Other lift types	4⅞ (12.4)	6⅞ (17.5)
<b>Cellular, Pleated, Fresco Roman, Solar, and Roller Shades</b>			
4½" (11.5 cm) Symphony Wood Cornice	All	3¾ (9.6)	4⅞ (11.6)
5½" (14.0 cm) Noble Wood Cornice	All	3¾ (9.6)	4¾ (12.1)
7½" (19.1 cm) Noble Wood Cornice	All	3¾ (9.6)	5⅞ (12.9)
5½" (14.0 cm) Regal Wood Cornice	All	3¾ (9.6)	5⅞ (13.2)
7½" (19.1 cm) Regal Wood Cornice	All	3¾ (9.6)	5¾ (14.7)
<b>Cellular Shade Vertical Application</b>			
4½" (11.5 cm) Symphony Wood Cornice	All	3⅞ (8.0)	3⅞ (10.1)
5½" (14.0 cm) Noble Wood Cornice	All	3⅞ (8.0)	4⅞ (10.5)
7½" (19.1 cm) Noble Wood Cornice	All	3⅞ (8.0)	4⅞ (11.3)
5½" (14.0 cm) Regal Wood Cornice	All	3⅞ (8.0)	4⅞ (11.6)
7½" (19.1 cm) Regal Wood Cornice	All	3⅞ (8.0)	5⅞ (13.1)

**NOTE:** Minimum return width is ½" (1.3 cm); maximum return width is 8" (20.4 cm).

Cornices are not available on bay or corner windows. If the cornice is to be used alone (no product selected), the return width must be specified at the time of the order.

## General Information

### Wood Cornice Returns

Cornice Type	Control Type	Standard Return Inside Width inches (cm)	Full Recess Depth inches (cm)
<b>Dual Shades</b>			
4½" (11.5 cm) Symphony Wood Cornice	All	5½ (14.0)	6⅞ (16.1)
5½" (14.0 cm) Noble Wood Cornice	All	5½ (14.0)	6½ (16.6)
7½" (19.1 cm) Noble Wood Cornice	All	5½ (14.0)	6⅜ (17.4)
5½" (14.0 cm) Regal Wood Cornice	All	5½ (14.0)	6⅞ (17.7)
7½" (19.1 cm) Regal Wood Cornice	All	5½ (14.0)	7½ (19.1)
<b>Natural Drapes</b>			
4½" (11.5 cm) Symphony Wood Cornice	All	6 (15.3)	6⅞ (17.4)
5½" (14.0 cm) Noble Wood Cornice	All	6 (15.3)	7 (17.8)
7½" (19.1 cm) Noble Wood Cornice	All	6 (15.3)	7⅞ (18.6)
5½" (14.0 cm) Regal Wood Cornice	All	6 (15.3)	7⅞ (18.9)
7½" (19.1 cm) Regal Wood Cornice	All	6 (15.3)	8 (20.4)
<b>Natural Shades</b>			
4½" (11.5 cm) Symphony Wood Cornice	All	3⅝ (9.3)	4⅞ (11.3)
5½" (14.0 cm) Noble Wood Cornice	All	3⅝ (9.3)	4⅝ (11.8)
7½" (19.1 cm) Noble Wood Cornice	All	3⅝ (9.3)	4⅝ (12.6)
5½" (14.0 cm) Regal Wood Cornice	All	3⅝ (9.3)	5⅞ (12.9)
7½" (19.1 cm) Regal Wood Cornice	All	3⅝ (9.3)	5⅝ (14.3)
<b>Sheer Vertical Blinds</b>			
4½" (11.5 cm) Symphony Wood Cornice	All	6¼ (15.9)	7⅞ (18.0)
5½" (14.0 cm) Noble Wood Cornice	All	6¼ (15.9)	7¼ (18.5)
7½" (19.1 cm) Noble Wood Cornice	All	6¼ (15.9)	7⅞ (19.3)
5½" (14.0 cm) Regal Wood Cornice	All	6¼ (15.9)	7⅞ (19.6)
7½" (19.1 cm) Regal Wood Cornice	All	6¼ (15.9)	8¼ (21.0)
<b>Sliding Panels</b>			
4½" (11.5 cm) Symphony Wood Cornice	All	5 (12.7)	5⅞ (14.8)
5½" (14.0 cm) Noble Wood Cornice	All	5 (12.7)	6 (15.3)
7½" (19.1 cm) Noble Wood Cornice	All	5 (12.7)	6⅞ (16.1)
5½" (14.0 cm) Regal Wood Cornice	All	5 (12.7)	6⅞ (16.4)
7½" (19.1 cm) Regal Wood Cornice	All	5 (12.7)	7 (17.8)
<b>Vertical Blinds</b>			
4½" (11.5 cm) Symphony Wood Cornice	All	5½ (14.0)	6⅞ (16.1)
5½" (14.0 cm) Noble Wood Cornice	All	5½ (14.0)	6½ (16.6)
7½" (19.1 cm) Noble Wood Cornice	All	5½ (14.0)	6⅜ (17.4)
5½" (14.0 cm) Regal Wood Cornice	All	5½ (14.0)	6⅞ (17.7)
7½" (19.1 cm) Regal Wood Cornice	All	5½ (14.0)	7½ (19.1)

**NOTE:** Dual shades can be configured with 7½" (19.1 cm) cornices. 5½" (14.0 cm) cornices are available only when dual shade has no cassette with inside mount and cornices are outside mount.

Minimum return width is ½" (1.3 cm); maximum return width is 8" (20.4 cm).

Cornices are not available on bay or corner windows. If the cornice is to be used alone (no product selected), the return width must be specified at the time of the order.



## General Information

Composite and Faux Wood Valance Returns			
Valance Type	Control Type	Standard Return Inside Width inches (cm)	Full Recess Depth inches (cm)
<b>2" (5.1 cm) Composite and Faux Wood Horizontal Blinds</b>			
3" (7.7 cm) Classic Composite or Faux Wood Valance	Cord tilt	2 <sup>7</sup> / <sub>16</sub> (7.4)	3 <sup>1</sup> / <sub>4</sub> (8.3)
	Wand tilt	3 <sup>7</sup> / <sub>16</sub> (9.1)	3 <sup>7</sup> / <sub>16</sub> (9.9)
	Cordless wand tilt	3 <sup>3</sup> / <sub>16</sub> (8.6)	3 <sup>3</sup> / <sub>16</sub> (9.6)
	Cordless cord tilt	2 <sup>3</sup> / <sub>4</sub> (7.0)	3 <sup>1</sup> / <sub>16</sub> (7.8)
3" (7.7 cm) Majestic Composite or Faux Wood Valance	Cord tilt	2 <sup>7</sup> / <sub>16</sub> (7.4)	3 <sup>3</sup> / <sub>16</sub> (8.6)
	Wand tilt	3 <sup>7</sup> / <sub>16</sub> (9.1)	4 <sup>1</sup> / <sub>16</sub> (10.4)
	Cordless wand tilt	3 <sup>3</sup> / <sub>16</sub> (8.6)	3 <sup>7</sup> / <sub>16</sub> (9.9)
	Cordless cord tilt	2 <sup>3</sup> / <sub>4</sub> (7.0)	3 <sup>3</sup> / <sub>16</sub> (8.1)
<b>2½" (6.4 cm) Composite and Faux Wood Horizontal Blinds</b>			
3" (7.7 cm) Classic Composite or Faux Wood Valance	Cord tilt	3 <sup>15</sup> / <sub>16</sub> (10.1)	4 <sup>1</sup> / <sub>4</sub> (10.8)
	Wand tilt	3 <sup>15</sup> / <sub>16</sub> (10.1)	4 <sup>1</sup> / <sub>4</sub> (10.8)
	Cordless wand tilt	3 <sup>3</sup> / <sub>4</sub> (9.6)	4 <sup>1</sup> / <sub>8</sub> (10.5)
	Cordless cord tilt	3 <sup>3</sup> / <sub>4</sub> (9.6)	4 <sup>1</sup> / <sub>8</sub> (10.5)
3" (7.7 cm) Majestic Composite or Faux Wood Valance	Cord tilt	3 <sup>15</sup> / <sub>16</sub> (10.1)	4 <sup>7</sup> / <sub>16</sub> (11.3)
	Wand tilt	3 <sup>15</sup> / <sub>16</sub> (10.1)	4 <sup>7</sup> / <sub>16</sub> (11.3)
	Cordless wand tilt	3 <sup>3</sup> / <sub>4</sub> (9.6)	4 <sup>1</sup> / <sub>4</sub> (10.8)
	Cordless cord tilt	3 <sup>3</sup> / <sub>4</sub> (9.6)	4 <sup>1</sup> / <sub>4</sub> (10.8)
<b>Artisan Fabric Roman Shades</b>			
3" (7.7 cm) Classic Composite or Faux Wood Valance	Cord lift	4 <sup>1</sup> / <sub>8</sub> (10.5)	4 <sup>3</sup> / <sub>8</sub> (11.2)
	Other lift types	4 <sup>7</sup> / <sub>8</sub> (12.4)	5 <sup>1</sup> / <sub>16</sub> (13.2)
3" (7.7 cm) Majestic Composite or Faux Wood Valance	Cord lift	4 <sup>1</sup> / <sub>8</sub> (10.5)	4 <sup>9</sup> / <sub>16</sub> (11.6)
	Other lift types	4 <sup>7</sup> / <sub>8</sub> (12.4)	5 <sup>1</sup> / <sub>16</sub> (13.5)
<b>Cellular, Pleated, Fresco Roman, Solar, and Roller Shades</b>			
3" (7.7 cm) Classic Composite or Faux Wood Valance	All	3 <sup>3</sup> / <sub>4</sub> (9.6)	4 <sup>1</sup> / <sub>16</sub> (10.4)
3" (7.7 cm) Majestic Composite or Faux Wood Valance	All	3 <sup>3</sup> / <sub>4</sub> (9.6)	4 <sup>3</sup> / <sub>16</sub> (10.7)
<b>Cellular Shade Vertical Application</b>			
3" (7.7 cm) Classic Composite or Faux Wood Valance	All	3 <sup>1</sup> / <sub>8</sub> (8.0)	3 <sup>1</sup> / <sub>16</sub> (8.8)
3" (7.7 cm) Majestic Composite or Faux Wood Valance	All	3 <sup>1</sup> / <sub>8</sub> (8.0)	3 <sup>3</sup> / <sub>16</sub> (9.1)
<b>Dual Shades</b>			
3" (7.7 cm) Classic Composite or Faux Wood Valance*	All	5 <sup>1</sup> / <sub>2</sub> (14.0)	5 <sup>13</sup> / <sub>16</sub> (14.8)
3" (7.7 cm) Majestic Composite or Faux Wood Valance*	All	5 <sup>1</sup> / <sub>2</sub> (14.0)	5 <sup>15</sup> / <sub>16</sub> (15.1)
<b>Natural Drapes</b>			
3" (7.7 cm) Classic Composite or Faux Wood Valance	All	6 (15.3)	6 <sup>5</sup> / <sub>16</sub> (16.1)
3" (7.7 cm) Majestic Composite or Faux Wood Valance	All	6 (15.3)	6 <sup>7</sup> / <sub>16</sub> (16.4)
<b>Natural Shades</b>			
3" (7.7 cm) Classic Composite or Faux Wood Valance	All	3 <sup>3</sup> / <sub>8</sub> (9.3)	3 <sup>13</sup> / <sub>16</sub> (10.1)
3" (7.7 cm) Majestic Composite or Faux Wood Valance	All	3 <sup>3</sup> / <sub>8</sub> (9.3)	4 <sup>1</sup> / <sub>16</sub> (10.4)
<b>Sheer Vertical Blinds</b>			
3" (7.7 cm) Classic Composite or Faux Wood Valance	All	6 <sup>1</sup> / <sub>4</sub> (15.9)	6 <sup>5</sup> / <sub>16</sub> (16.7)
3" (7.7 cm) Majestic Composite or Faux Wood Valance	All	6 <sup>1</sup> / <sub>4</sub> (15.9)	6 <sup>11</sup> / <sub>16</sub> (17.0)
<b>Sliding Panels</b>			
3" (7.7 cm) Classic Composite or Faux Wood Valance	All	5 (12.7)	5 <sup>5</sup> / <sub>16</sub> (13.5)
3" (7.7 cm) Majestic Composite or Faux Wood Valance	All	5 (12.7)	5 <sup>7</sup> / <sub>16</sub> (13.9)
<b>Vertical Blinds</b>			
3" (7.7 cm) Classic Composite or Faux Wood Valance	All	5 <sup>1</sup> / <sub>2</sub> (14.0)	5 <sup>13</sup> / <sub>16</sub> (14.8)
3" (7.7 cm) Majestic Composite or Faux Wood Valance	All	5 <sup>1</sup> / <sub>2</sub> (14.0)	5 <sup>15</sup> / <sub>16</sub> (15.1)

\*Faux wood and composite valances not recommended due to valance heights.

**NOTE:** Minimum return width is ½" (1.3 cm); maximum return width is 8" (20.4 cm). Valance returns ½" (1.3 cm) to 1" (2.6 cm) will be glued, 1<sup>1</sup>/<sub>16</sub>" (2.7 cm) to 4<sup>5</sup>/<sub>16</sub>" (11.8 cm) will be optional glued, 4<sup>11</sup>/<sub>16</sub>" (12.0 cm) and greater cannot be glued.

Valances only available on bay or corner windows if bay or corner application is available on entire product line selected. See price list of product selected for measuring instructions. If the valance is to be used alone (no product selected), the return width must be specified at the time of the order.

## General Information

### How to Measure for Valance Returns

Window depths vary considerably depending on the age and style of the window.

**Always** measure the window depth, regardless of the type of window treatment the client is considering. Knowing the depth when the order is placed can help prevent costly errors.

Use the information in your price list for wood, composite, and faux wood to calculate the needed return width (see previous pages).

To calculate the return width, use this formula:

[standard return width] minus [client window depth] =  
special return length to order for inside mount blind

#### REMEMBER:

- Smallest return width is  $\frac{1}{2}$ " (1.3 cm) (inside measurement)
- Returns  $\frac{1}{2}$ " (1.3 cm) to 1" (2.6 cm) (inside measurement) will be glued;
- returns  $1\frac{1}{16}$ " (2.7 cm) to  $4\frac{5}{16}$ " (11.8 cm) (inside measurement) have the option of being glued
- The width of a return and the width of a valance are measured on the inside (back side) of the valance, not the outside (face) of the valance (see diagram at right)
- Standard return size for  $2\frac{3}{8}$ " (6.1 cm) blinds—  
subtract  $\frac{3}{16}$ " (0.5 cm) prior to determining special return width
- Standard return size for  $2\frac{1}{2}$ " (6.4 cm) blinds—  
subtract  $\frac{3}{8}$ " (1.0 cm) prior to determining special return width

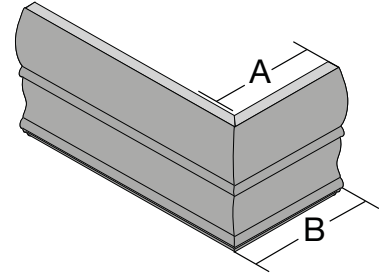

A: Inside Measurement  
B: Outside Measurement

# General Information

## How to Measure and Order Cornices and Valances

Wood cornices and valances are optional with your custom order or as a stand-alone order.

**NOTE:** Cornices and valances with returns are measured and cut from the **INSIDE** of the miter to ensure the most accurate fit when installed over the headrail or window frame.

### Outside Mount

- Cornices and valances are supplied with returns sized to cover the end of the blinds back to the mounting surface
- Custom returns may be ordered up to 8" (20.4 cm); minimum return is ½" (1.3 cm)
- Cornices include a dust cover to conceal the top of the blind

### Inside Mount

- Cornices and valances are supplied without returns and look best when the blinds and valance or cornice can be completely recessed
- Ends of the valance and cornice are straight-cut
- Cornices do NOT have a dust cover and returns are NOT available
- Returns for inside mount valances must be specified

### Additional Ordering Information

- Please state at the time of order if the valance or cornice return measurements are for the **EXACT** size required so that no additions or deductions are made
- Cornices and valances will be shipped separately from blind
- Manufacturer recommends installing blind and valance/cornice at the same time

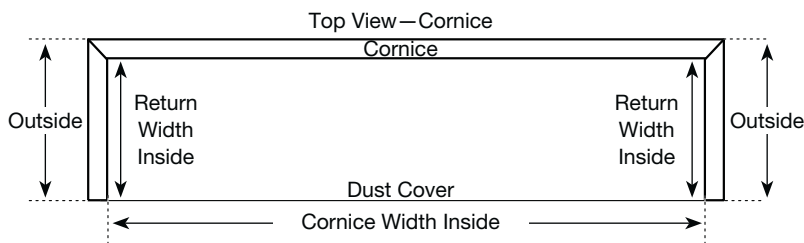

### Side View—Cornice

1. Full recess is from front of cornice to wall.
2. Return width is from miter to wall.

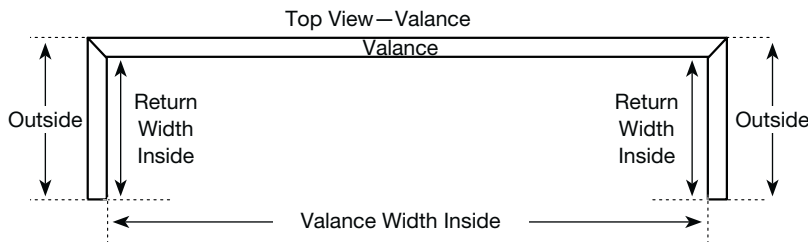
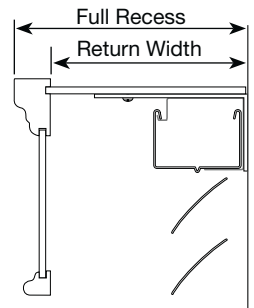

### Side View—Valance

1. Full recess is from front of valance to wall.
2. Return width is from miter to wall.
3. Partial recess—subtract actual window recess from return width to arrive at exact return width.

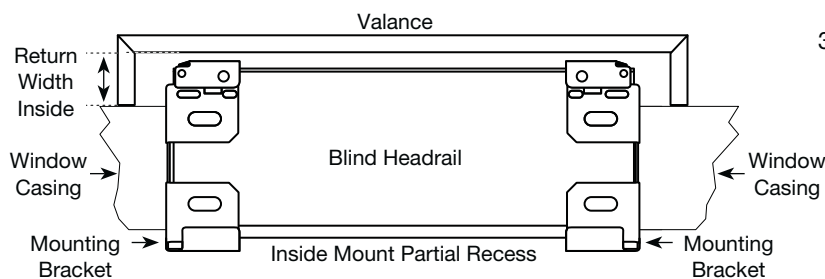
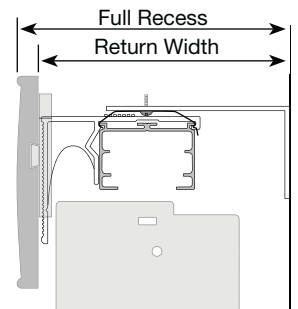

## General Information

### How to Measure a Special Splice Location

A keystone is supplied for valance and cornice widths that require a splice. Keystone will be equally spaced unless a special splice location is requested at time of order. The placement of the splice will be calculated by the factory using an INSIDE measurement from the mitered corner to the location specified on the order.

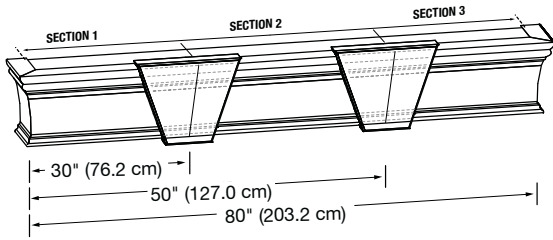

Each splice location should be recorded starting from the LEFT BACKSIDE corner.

**EXAMPLE:** Overall valance width = 80" (203.2 cm) backside measurement  
First splice from left = 30" (76.2 cm) backside measurement  
Second splice from left = 50" (127.0 cm) backside measurement

See size considerations for cornice and valance manufacturing formulas to determine exact back width size your cornice or valance will be prior to selecting splice locations.

For keystone pricing, see pricing pages.

**NOTE:** All measurements need to be from backside.

### Custom Color

Graber® offers the unique option of custom color in either paint or stain. Use the following guidelines when placing your order.

With your order, please send a color chip (at least a 2" (5.1 cm) square sample) with the color name on the sample. A sample of the color can be requested before blinds are manufactured for your approval. An approval color sample will be automatically sent on orders for six or more blinds. A customer may waive their sample if they do not wish to receive one. Samples usually add approximately two (2) weeks to the lead time of an order. If a color sample is not requested, the sample you provided will be used to manufacture the wood blinds. If the color chip is to be returned to you, please note this on your order.

Please send all color chips to:

Springs Window Fashions, LLC  
ATTN: Graber Custom Color  
33 West 3rd Street, Suite 400  
Williamsport, PA 17701

**NOTE:** Due to the nature of the custom color process, manufacturing requires an extended lead time. The standard manufacturing process does not apply. Lead-times vary depending on sizes and quantities ordered.

# General Information

## Mounting Brackets

### Universal Cornice Mounting Bracket

- L-brackets
- Standard when ordered with
  - Any inside mount cornice
  - Outside mount cornice with returns greater than 1 3/4" (4.5 cm)

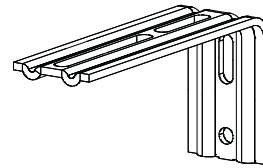

L-Bracket

### Short Return Cornice Mounting Bracket

- Bracket and hanger
- Standard when ordered with
  - Outside mount cornice with return width 1/2" (1.3 cm) to 1 3/4" (4.5 cm)

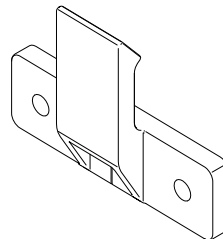

Hanger

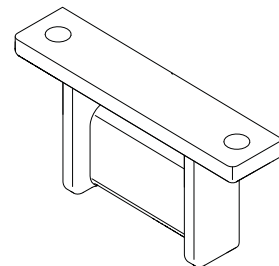

Bracket

### Universal Valance Mounting Bracket

- Standard when ordered for any of the following products
  - Cellular, pleated, soft, artisan fabric Roman, fresco Roman, solar, and roller shades
  - Cellular shade vertical application
  - Dual shades
  - Sliding panels
  - Sheer vertical blinds
  - Vertical blinds
  - Natural shades or drapes
  - Other or alone

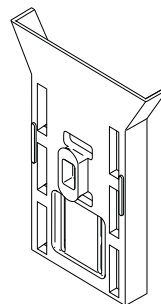

Valance Slide

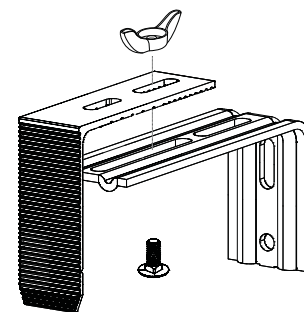

### Horizontal Valance Mounting Bracket

- Clip and slide brackets
- Projection width depends on slat size and control type selected
- Standard when ordered for any of the following products
  - 2" (5.1 cm) aluminum horizontal blinds
  - 2" (5.1 cm) and 2 1/2" (6.4 cm) faux wood blinds
  - 2" (5.1 cm) vinyl horizontal blinds
  - 1" (2.6 cm), 2" (5.1 cm), and 2 3/8" (6.1 cm) wood blinds

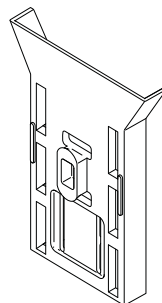

Valance Slide

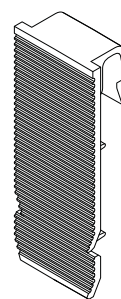

Short Valance Clip  
(Available with  
1" (2.6 cm), 2" (5.1 cm)  
cord tilt, or motorized tilt)

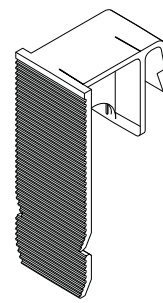

Long Valance Clip  
(Available with wand tilt  
or slat sizes greater  
than 2" (5.1 cm))



## Price Charts

### Wood Cornice Pricing

Width up to inches (cm) →	23 (58.5)	30 (76.2)	36 (91.5)	42 (106.7)	48 (122.0)	54 (137.2)	60 (152.4)	66 (167.7)	72 (182.9)	78 (198.2)	84 (213.4)	90 (228.6)	96 (243.9)	106 (269.3)	116 (294.7)
4½" (11.5 cm) Symphony Wood Cornice*	\$230	248	259	272	296	319	347	356	364	378	403	407	647	666	684
5½" (14.0 cm) Regal Wood Cornice	289	307	319	342	364	388	417	433	448	463	508	514	774	799	822
7½" (19.1 cm) Regal Wood Cornice	370	392	405	425	445	463	481	502	513	541	580	622	925	958	989
5½" (14.0 cm) Noble Wood Cornice	242	261	274	293	319	342	370	385	397	410	439	445	702	724	744
7½" (19.1 cm) Noble Wood Cornice	344	368	383	398	412	429	448	463	479	513	561	603	906	933	963

Width up to inches (cm) →	126 (320.1)	136 (345.5)	146 (370.9)	156 (396.3)	166 (421.7)	176 (447.1)	186 (472.5)	192 (487.7)	216 (548.7)	240 (609.6)	264 (670.6)	283 (718.9)	312* (792.5)	336 (853.5)	366 (929.7)
4½" (11.5 cm) Symphony Wood Cornice*	\$700	721	739	757	774	793	811	1061	1077	1115	1152	1189	1456		
5½" (14.0 cm) Regal Wood Cornice	845	869	893	918	941	966	989	1267	1291	1339	1387	1435	1737	1784	1832
7½" (19.1 cm) Regal Wood Cornice	1023	1056	1088	1121	1154	1188	1220	1516	1547	1616	1680	1745	2075	2141	2205
5½" (14.0 cm) Noble Wood Cornice	761	783	803	822	842	862	881	1153	1171	1212	1253	1291	1583	1622	1661
7½" (19.1 cm) Noble Wood Cornice	989	1019	1047	1077	1105	1134	1162	1452	1482	1539	1595	1652	1972	2028	2086

\*Maximum width 300¾" (764.0 cm).

**NOTE:** Includes returns (if requested) and mounting hardware.  
Minimum width 8" (20.4 cm) exact.

### Decorative Cornice Keystone Pricing

- Keystones are included in the price of a spliced cornice; additional keystones are available as a surcharge
- Surcharge
  - 7½" (19.1 cm) noble and regal: \$228 each
  - 5½" (14.0 cm) noble and regal: \$218 each
  - 4½" (11.5 cm) symphony: \$193 each
- Maximum keystones on single piece cornice is 3

### Custom Color Pricing

- Custom color pricing: \$149 net surcharge per color

# Price Charts

## Wood Valance Pricing

Width up to inches (cm) →	24 (61.0)	32 (81.3)	36 (91.5)	42 (106.7)	48 (122.0)	54 (137.2)	60 (152.4)	66 (167.7)	72 (182.9)	78 (198.2)	84 (213.4)	90 (228.6)	96 (243.9)	106 (269.3)	116 (294.7)	126 (320.1)	136 (345.5)
3" (7.7 cm) Classic Wood Valance	\$41	50	57	63	67	70	79	87	91	96	104	108	112	126	139	149	158
3½" (8.9 cm) Craftsman Wood Valance	43	52	61	65	70	79	82	89	95	100	108	110	116	130	142	152	162
3½" (8.9 cm) Legacy Wood Valance	43	52	61	65	70	79	82	89	95	100	108	110	116	130	142	152	162
4½" (11.5 cm) Symphony Wood Valance	51	58	66	71	79	87	91	96	101	109	111	117	127	146	156	169	180

Width up to inches (cm) →	146 (370.9)	156 (396.3)	166 (421.7)	176 (447.1)	186 (472.5)	196 (497.9)	206 (523.3)	216 (548.7)	226 (574.1)	236 (599.5)	246 (624.9)	256 (650.3)	266 (675.7)	276 (701.1)	286 (726.5)	296 (751.9)	300 (762.0)
3" (7.7 cm) Classic Wood Valance	\$170	180	190	201	212	222	232	242	255	264	274	286	296	306	317	328	337
3½" (8.9 cm) Craftsman Wood Valance	173	183	194	205	215	226	236	247	258	268	277	289	299	309	321	331	342
3½" (8.9 cm) Legacy Wood Valance	173	183	194	205	215	226	236	247	258	268	277	289	299	309	321	331	342
4½" (11.5 cm) Symphony Wood Valance	192	203	215	227	238	251	262	273	286	297	308	321	332	344	356	367	379

**NOTE:** Includes returns (if requested) and mounting hardware.  
Minimum width 8" (20.4 cm) exact. Maximum width 300¾" (764.0 cm).

## Decorative Wood Valance Keystone Pricing

- Keystones are included in the price of a spliced valance; additional keystones are available as a surcharge
- Surcharge
  - 3" (7.7 cm) classic wood valance: \$24 each
  - 3½" (8.9 cm) craftsman wood valance: \$24 each
  - 3½" (8.9 cm) legacy wood valance: \$24 each
  - 4½" (11.5 cm) symphony wood valance: \$24 each
- Maximum keystones on a single valance is 3

## Custom Color Pricing

- Custom color pricing: \$149 net surcharge per color

## Composite and Faux Wood Valance Pricing

Width up to inches (cm) →	24 (61.0)	32 (81.3)	36 (91.5)	42 (106.7)	48 (122.0)	54 (137.2)	60 (152.4)	66 (167.7)	72 (182.9)	78 (198.2)	84 (213.4)	90 (228.6)	96 (243.9)	106 (269.3)	116 (294.7)	126 (320.1)	136 (345.5)
3" (7.7 cm) Classic Composite and Faux Wood Valance	\$35	40	46	51	56	62	66	70	76	81	88	94	99	108	117	125	135
3" (7.7 cm) Majestic Composite and Faux Wood Valance	42	51	58	64	68	75	77	85	91	96	105	107	112	122	132	144	154

Width up to inches (cm) →	146 (370.9)	156 (396.3)	166 (421.7)	176 (447.1)	186 (472.5)	196 (497.9)	206 (523.3)	216 (548.7)	226 (574.1)	236 (599.5)	246 (624.9)	256 (650.3)	266 (675.7)	276 (701.1)	286 (726.5)	296 (751.9)	300 (762.0)
3" (7.7 cm) Classic Composite and Faux Wood Valance	\$145	154	163	172	182	190	200	209	219	228	237	245	256	265	274	283	293
3" (7.7 cm) Majestic Composite and Faux Wood Valance	164	175	185	195	206	217	227	237	247	259	269	279	290	299	310	320	331

**NOTE:** Includes returns (if requested) and mounting hardware.  
Minimum width 8" (20.4 cm) exact. Maximum width 300¾" (764.0 cm).  
Spliced faux wood valances not available with keystones.

## Palladian Window Shelf Pricing

Width up to inches (cm) →	24 (61.0)	32 (81.3)	36 (91.5)	42 (106.7)	48 (122.0)	54 (137.2)	60 (152.4)	66 (167.7)	72 (182.9)	78 (198.2)	84 (213.4)	90 (228.6)	96 (243.9)
Palladian Window Shelf	\$86	114	127	150	171	193	214	235	257	277	299	321	342

**NOTE:** Minimum width 7" (17.8 cm) exact.

# GRABER®

Grabber is a brand of Springs Window Fashions, the Best Experience Company 

Grabber and the Grabber logo are registered trademarks of Springs Window Fashions, LLC.

19-0755-00 (02/19) 18-10494|S18-10148