

TRADITIONS® WOOD, ELITE WOOD, COMPOSITE, AND LAKE FOREST® FAUX WOOD BLINDS

Table of Contents

Features

The Graber® Wood Story	3
Graber Wood Characteristics	3
Traditions Wood Blinds	4
Elite Wood Blinds	4
Elite Wood Blinds—Authentic Hardwoods	4
Traditions Composite Blinds	4
Lake Forest Premium Faux Wood and Faux Wood Blinds	4

Size Considerations

Cord Lift, Depth Requirements for Inside Mount	5-6
Cordless Lift, Depth Requirements for Inside Mount	7

Options

Blind Options	8
Cordless Lift	9
Motorized Tilt	9
Multiple Blinds on One Headrail	10
NoHoles™	11
Cut-Out Blinds	11
Control Lengths for Cords and Wands	11
Bay and Corner Windows	12
Cloth Tapes	13
Decorative Tassels	14
Accent Color	14
Custom Color	14
Why Elite Wood for Your Client's Home	14
How to Order Elite Wood: Special Ordering Instructions	14
Valance Options	15-16
How to Measure for Valance Returns	17
How to Measure and Order Valances	17
Valance Keystones	18
Splicing Requirements	18
How to Measure a Special Splice Location	18
Wood Specialty Shapes: Incline Wire Blinds	19
Wood Specialty Shapes: Angle Top or Bottom	20
Wood Specialty Shapes: Trapezoid, Triangle, and Octagon	21
Wood Specialty Shapes: Arched Blinds	22
Wood Specialty Shapes: Ovals and Circles	23
Making a Template for Specialty Blinds	24
Using the Graber Template Service	24

GRABER®

UNITED STATES PRICE LIST • FEBRUARY 2019

Table of Contents

General Information

Slat Count Table: 1" (2.6 cm) Wood Blinds	25
Slat Count Table: 2" (5.1 cm) Wood Blinds	26
Slat Count Table: 2 ³ / ₈ " (6.1 cm) Wood Blinds	27
Slat Count Table: 2" (5.1 cm) Composite, Premium Faux Wood, and Faux Wood Blinds	28
Slat Count Table: 2 ¹ / ₂ " (6.4 cm) Composite, Premium Faux Wood, and Faux Wood Blinds	29
Slat Route and Ladder Count Charts: Traditions® 1" (2.6 cm) Wood Blinds, Traditions 2" (5.1 cm) and 2 ³ / ₈ " (6.1 cm) Wood Blinds, Traditions 2" (5.1 cm) and 2 ³ / ₈ " (6.1 cm) Wood Blinds with Cordless Lift	30
Slat Route and Ladder Count Charts: 2" (5.1 cm) and 2 ³ / ₈ " (6.1 cm) Elite Wood Blinds, 2" (5.1 cm) and 2 ³ / ₈ " (6.1 cm) Elite Wood Blinds with Cordless Lift	31
Slat Route and Ladder Count Charts: Traditions 2" (5.1 cm) and 2 ¹ / ₂ " (6.4 cm) Composite Blinds, Traditions 2" (5.1 cm) and 2 ¹ / ₂ " (6.4 cm) Composite Blinds with Cordless Lift	32
Slat Route and Ladder Count Charts: Premium Faux Wood and Faux Wood Blinds, Lake Forest 2" (5.1 cm) and 2 ¹ / ₂ " (6.4 cm) Premium Faux Wood and Faux Wood Blinds with Cordless Lift	33
Traditions 1" (2.6 cm), 2" (5.1 cm), and 2 ³ / ₈ " (6.1 cm) Wood and 2" (5.1 cm) and 2 ³ / ₈ " (6.1 cm) Elite Wood Blinds Product Detail	34
Cordless Lift Blinds Product Detail: Wood, Composite, and Faux Wood	35
Traditions 2" (5.1 cm) and 2 ¹ / ₂ " (6.4 cm) Composite Blinds Product Detail	36
Lake Forest 2" (5.1 cm) and 2 ¹ / ₂ " (6.4 cm) Premium Faux Wood and Faux Wood Blinds Product Detail	37

Wood Vertical Blinds

Features	38
Size Considerations	38
Depth Requirements for Inside Mount	38
Options: Cord and Chain Control	39
Paired Blinds	39
Replacement Vane Ordering	39
Stacking Chart and How to Measure for an Uncovered Window	40
Product Detail	41

Price Charts and Options Pricing

Price Group A: Traditions 1" (2.6 cm) Wood Blinds	43
Price Group B: Traditions 2" (5.1 cm) Wood Blinds	44
Price Group C: Traditions 2 ³ / ₈ " (6.1 cm) Wood Blinds	45
Price Group D: Traditions 2" (5.1 cm) Wood Blinds—Unique Finishes: Barnwood, Distressed	46
Price Group E: 2" (5.1 cm) Elite Wood Blinds	47
Price Group F: 2 ³ / ₈ " (6.1 cm) Elite Wood Blinds	48
Price Group G: 2" (5.1 cm) Elite Wood Blinds—Authentic Hardwoods	49
Price Group H: Angle Top or Bottom, Trapezoid, Triangle, Octagon, and Arched Blinds	50
Price Group I: Circle and Oval Blinds	50
Price Group J: Elite Wood Vertical Blinds	51
Price Group K: Traditions 2" (5.1 cm) Composite Blinds	52
Price Group L: Traditions 2 ¹ / ₂ " (6.4 cm) Composite Blinds	53
Price Group M: Lake Forest 2" (5.1 cm) Premium Faux Wood Blinds	54
Price Group N: Lake Forest 2 ¹ / ₂ " (6.4 cm) Premium Faux Wood Blinds	55
Price Group O: Lake Forest 2" (5.1 cm) Faux Wood Blinds	56
Price Group P: Lake Forest 2 ¹ / ₂ " (6.4 cm) Faux Wood Blinds	57
Options Pricing	58

Features

The Graber® Wood Story

Quality of Wood Defines a Blind's Quality

We use only 100% North American hardwood in the construction of our wood blinds because of its light weight, consistent color, hardness, structural stability, and attractive grain.

Sound Forestry Techniques

We work only with foresters who practice “sustained yield forest management”—nearly twice as much hardwood grows as is harvested in the U.S. each year. The volume of hardwoods in American forests today is greater than it was 50 years ago.

Preserving Our Natural Resources

Our Springs Window Fashions (SWF) wood products facility consumes recycled sawdust and wood shavings, generating the heat required to dry lumber for a completely self-sufficient manufacturing process. Our Reynosa, Mexico fabrication and finishing facility is 99.7% pollution free, above any U.S. standard.

SWF Wood Products, Grayling, Michigan

We have control over the quality of wood used—we control the process from green lumber to finished blinds. Hardwoods used in crafting Graber Wood Blinds are kiln dried and molded at our SWF wood products facility in Grayling, Michigan. The wood is dried slowly to strict wood blind specifications because structural change can occur when moisture is removed. Molding and sanding operations provide the highest quality surface, free of defects.

Springs Window Fashions, Reynosa, Mexico

At our state-of-the-art finishing plant in Reynosa, Mexico, components are carefully sorted prior to fabrication for color uniformity and wood characteristics. We sort wood as an end user, rather than a finishing vendor, taking out defects in a climate-controlled building. To finish the blind, we use only high quality paints and stains; on-site certified color technicians provide both application and quality control.

What Makes Graber Traditions® Blinds Different from the Rest?

- Painted and stained wood blinds are made from 100% North American hardwoods, the premier wood used in the construction of blinds
- SWF wood products and finishing facilities provide state-of-the-art technologies and processes
- Expanded choice of finishes with PureGrain™ Finish—vibrant stains that showcase the natural grain of the wood
- Unique valance choices, cloth tapes, specialty shapes, and more
- Traditions composite blinds have superior strength and moisture resistance
- The best customer service team in the industry—trained to answer any question about Graber Traditions Blinds
- Limited lifetime warranty

Graber Wood Characteristics

Wood used to manufacture Graber Wood Blinds has many natural characteristics that make it truly unique. The following are all natural characteristics of wood, and we do not consider them to be defects:

- Grain—The direction, size, and appearance of wood fibers vary greatly depending on where the wood is cut from within the tree
- Tiger Striping—Occurs when a tree develops wavy grain, due to genetics, soil content, or other natural scenarios
- Burl—Formed from an irregular growth on the outer edge of the tree
- Bird's Eye—Small area on the surface of the board where fibers are contorted to form circular figures that resemble birds' eyes
- Pin Knots—Vary in size, shape, structure, and color
- Mineral Marks—Dark or discolored areas caused by minerals which the tree extracts from the water or soil; can be either a streak or a stain, usually blackish blue
- Knotty Pine/Rustic—Material contains markings that are more extreme than in standard products; the number and degree of marking will vary throughout the blind

Please be assured that these markings in no way affect the durability or the structural integrity of the blind.

Natural variations in color and grain are inherent in the beauty of wood. These variations are within established industry guidelines and should be expected. In addition, blinds may stain slightly darker or lighter than the swatches shown in the sampling.

NOTE: Elite Walnut, Maple, and Cherry will have the unique natural variations of these beautiful hardwoods—these variations are to be expected. Blinds made from these materials will undergo a degree of color change over time, further enhancing the beauty of the wood.

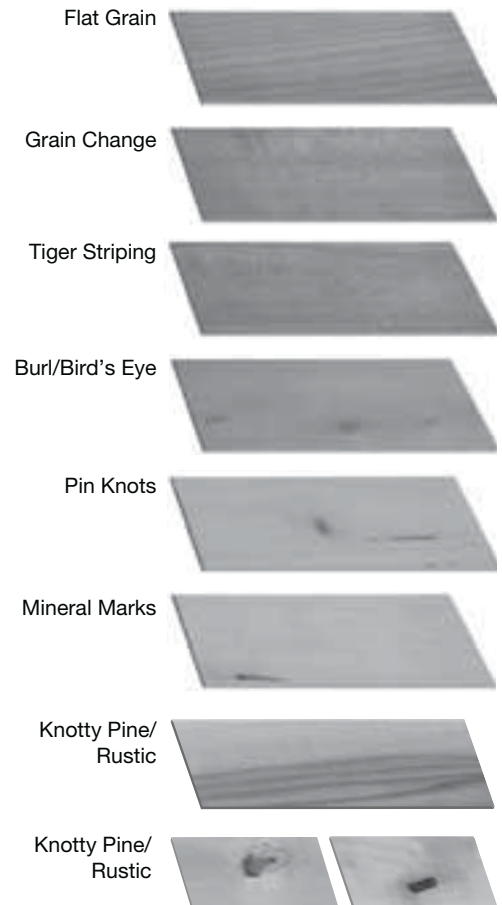

Features

Traditions® Wood Blinds

- Stained and painted blinds crafted from North American hardwoods
- Finish highlights the natural characteristics of wood
- 1" (2.6 cm), 2" (5.1 cm), and 2 $\frac{3}{8}$ " (6.1 cm) slat sizes available
- Sandblast is not available on keystones
- Cordless lift option; not available on 1" (2.6 cm)
- NoHoles™ option available for maximum privacy; not available on 1" (2.6 cm) or with cordless lift
- Easy grip bottomrail for superior closure; makes lifting and lowering cordless lift blinds easier; not available on 1" (2.6 cm)
- Decorative cloth tape option; not available with 1" (2.6 cm) or NoHoles
- Decorative tassel selection

Elite Wood Blinds

- Available in all Graber® wood paints and stains
- 2" (5.1 cm) and 2 $\frac{3}{8}$ " (6.1 cm) slat sizes available
- Sandblast finish available on any 2" (5.1 cm) paint or stain
- Custom color available; not available in unique finishes
- Cordless lift option
- NoHoles option available for maximum privacy; not available with cordless lift
- Easy grip bottomrail for superior closure; makes lifting and lowering cordless lift blinds easier
- Decorative cloth tape option; not available with NoHoles
- Decorative tassel selection
- Specialty shapes
- Accent valance and bottomrail: complement the window and décor of the room by specifying a different color valance and bottomrail

Elite Wood Blinds—Authentic Hardwoods

- 2" (5.1 cm) wood blinds made from premier North American hardwoods—Walnut, Maple, and Cherry with a clear coat finish that further enhances the wood's beauty
- Cordless lift option
- NoHoles option available for maximum privacy; not available with cordless lift
- Easy grip bottomrail for superior closure; makes lifting and lowering cordless lift blinds easier
- Decorative cloth tape option; not available with NoHoles
- Decorative tassel selection

Traditions Composite Blinds

- Moisture-resistant multiple polymer composite slats
- 2" (5.1 cm) and 2 $\frac{1}{2}$ " (6.4 cm) slat sizes available
- Cordless lift option
- NoHoles option available for maximum privacy; not available with cordless lift
- Trapezoid bottomrail for superior closure
- Decorative cloth tape option; not available with NoHoles

Lake Forest® Premium Faux Wood and Faux Wood Blinds

- Solid or woodgrain moisture-resistant engineered polymer slats
- 2" (5.1 cm) and 2 $\frac{1}{2}$ " (6.4 cm) slat sizes available in both premium faux wood and faux wood
- Cordless lift option
- NoHoles option available for maximum privacy; not available with cordless lift
- Trapezoid bottomrail for superior closure; available on premium faux wood blinds only
- Rectangular bottomrail; available on faux wood blinds only
- Decorative cloth tape option; not available with NoHoles

Size Considerations



Cord Lift

Styles	Price Group	Cord Lift Blinds				Cord Lift Blinds Multiple Blinds on One Headrail				
		Width		Height		Width			Height	
		Min (exact) inches (cm)	Max inches (cm)	Min inches (cm)	Max inches (cm)	Min Panel (exact) inches (cm)	Max Panel inches (cm)	Max Blind inches (cm)	Min Blind inches (cm)	Max Blind inches (cm)
		Traditions® Wood Blinds								
Traditions 1" (2.6 cm) Wood Blinds	A	7 (17.8)	96 (243.9)	12 (30.5)	120 (304.8)	7 (17.8)	96 (243.9)	120 (304.8)	12 (30.5)	120 (304.8)
Traditions 2" (5.1 cm) Wood Blinds	B	7 (17.8)	96 (243.9)	12 (30.5)	120 (304.8)	7 (17.8)	96 (243.9)	120 (304.8)	12 (30.5)	120 (304.8)
Traditions 2" (5.1 cm) Barnwood and Distressed Wood Blinds	D	7 (17.8)	96 (243.9)	12 (30.5)	120 (304.8)	7 (17.8)	96 (243.9)	120 (304.8)	12 (30.5)	120 (304.8)
Traditions 2½" (6.1 cm) Wood Blinds	C	7 (17.8)	96 (243.9)	12 (30.5)	120 (304.8)	7 (17.8)	96 (243.9)	120 (304.8)	12 (30.5)	120 (304.8)
Exceptions: 1" (2.6 cm) blinds 7" (17.8 cm) to 8 ¹⁵ / ₁₆ " (22.8 cm) center tilt only; no lift 13 ¹⁵ / ₁₆ " (35.1 cm) minimum for same side controls					Exceptions: 2" (5.1 cm) and 2½" (6.1 cm) blinds 7" (17.8 cm) to 11 ¹⁵ / ₁₆ " (30.4 cm) center tilt only; no lift 7" (17.8 cm) to 8 ¹⁵ / ₁₆ " (22.8 cm) not available with cloth tapes					
Elite Wood Blinds										
Elite 2" (5.1 cm) Wood Blinds	E	7 (17.8)	96 (243.9)	12 (30.5)	120 (304.8)	7 (17.8)	96 (243.9)	120 (304.8)	12 (30.5)	120 (304.8)
Elite 2" (5.1 cm) Authentic Hardwood Blinds	G	7 (17.8)	96 (243.9)	12 (30.5)	120 (304.8)	7 (17.8)	96 (243.9)	120 (304.8)	12 (30.5)	120 (304.8)
Elite 2½" (6.1 cm) Wood Blinds	F	7 (17.8)	96 (243.9)	12 (30.5)	120 (304.8)	7 (17.8)	96 (243.9)	120 (304.8)	12 (30.5)	120 (304.8)
Exceptions: 2" (5.1 cm) and 2½" (6.1 cm) blinds 7" (17.8 cm) to 11 ¹⁵ / ₁₆ " (30.4 cm) center tilt only 16 ¹ / ₁₆ " (40.8 cm) minimum for same side controls 7" (17.8 cm) to 8 ¹⁵ / ₁₆ " (22.8 cm) not available with cloth tapes										
Traditions Composite Blinds										
Traditions 2" (5.1 cm) Composite Blinds	K	7 (17.8)	96 (243.9)	12 (30.5)	120 (304.8)	7 (17.8)	96 (243.9)	120 (304.8)	12 (30.5)	120 (304.8)
Traditions 2½" (6.4 cm) Composite Blinds	L	7 (17.8)	96 (243.9)	12 (30.5)	120 (304.8)	7 (17.8)	96 (243.9)	120 (304.8)	12 (30.5)	120 (304.8)
Exceptions: 2" (5.1 cm) and 2½" (6.4 cm) blinds 7" (17.8 cm) to 11 ¹⁵ / ₁₆ " (30.4 cm) center tilt only; no lift 16 ¹ / ₁₆ " (40.8 cm) minimum for same side controls 7" (17.8 cm) to 8 ¹⁵ / ₁₆ " (22.8 cm) not available with cloth tapes										
Lake Forest® Premium Faux Wood and Faux Wood Blinds										
Lake Forest 2" (5.1 cm) Premium Faux Wood Blinds	M	7 (17.8)	96 (243.9)	12 (30.5)	120 (304.8)	7 (17.8)	96 (243.9)	120 (304.8)	12 (30.5)	120 (304.8)
Lake Forest 2" (5.1 cm) Faux Wood Blinds	O	7 (17.8)	96 (243.9)	12 (30.5)	120 (304.8)	7 (17.8)	96 (243.9)	120 (304.8)	12 (30.5)	120 (304.8)
Lake Forest 2½" (6.4 cm) Premium Faux Wood Blinds	N	7 (17.8)	96 (243.9)	12 (30.5)	120 (304.8)	7 (17.8)	96 (243.9)	120 (304.8)	12 (30.5)	120 (304.8)
Lake Forest 2½" (6.4 cm) Faux Wood Blinds	P	7 (17.8)	96 (243.9)	12 (30.5)	120 (304.8)	7 (17.8)	96 (243.9)	120 (304.8)	12 (30.5)	120 (304.8)
Exceptions: 2" (5.1 cm) and 2½" (6.4 cm) blinds 7" (17.8 cm) to 11 ¹⁵ / ₁₆ " (30.4 cm) center tilt only; no lift 7" (17.8 cm) to 8 ¹⁵ / ₁₆ " (22.8 cm) not available with cloth tapes Same side controls not available with any size										

Size Considerations

Cord Lift

Depth Requirements for Inside Mount

Blind Type	Headrail Dimensions inches (cm)	 Partially recessed headrail in window casing/molding	Flush with Casing (without valance)*	
			Cord Tilt inches (cm)	Wand Tilt inches (cm)
Traditions® 1" (2.6 cm) Wood	1 x 1½ (2.6 x 3.9)	 Minimum Depth Mount inches (cm)	N/A	1½ (4.8)
Traditions 2" (5.1 cm) Wood	1½ x 2¼ (4.2 x 5.8)		2½ (6.7)	3% (8.6)
Traditions 2½" (6.1 cm) Wood [^]	1½ x 2¼ (4.2 x 5.8)		2½ (6.7)	3% (8.6)
Elite Wood 2" (5.1 cm) Wood 2" (5.1 cm) Authentic Hardwood	1½ x 2¼ (4.2 x 5.8)		2½ (6.7)	3% (8.6)
Elite Wood 2½" (6.1 cm) Wood [^]	1½ x 2¼ (4.2 x 5.8)		2½ (6.7)	3% (8.6)
Traditions 2" (5.1 cm) Composite	1½ x 2¼ (4.2 x 5.8)		2½ (6.7)	3% (8.6)
Traditions 2½" (6.4 cm) Composite [^]	1½ x 2¼ (4.2 x 5.8)		2½ (6.7)	3% (8.6)
Lake Forest® 2" (5.1 cm) Premium Faux Wood 2" (5.1 cm) Faux Wood	1½ x 2¼ (4.2 x 5.8)		2½ (6.7)	3% (8.6)
Lake Forest 2½" (6.4 cm) Premium Faux Wood [^] 2½" (6.4 cm) Faux Wood [^]	1½ x 2¼ (4.2 x 5.8)		2½ (6.7)	3% (8.6)

*For measurements of fully recessed headrails with a valance, see valance options.

[^]Additional clearance may be required for larger slat sizes.

Size Considerations

Cordless Lift

Styles	Price Group	Cordless Lift Blinds				Cordless Lift Blinds Multiple Blinds on One Headrail				
		Width		Height		Width			Height	
		Min (exact) inches (cm)	Max inches (cm)	Min inches (cm)	Max inches (cm)	Min Panel (exact) inches (cm)	Max Panel inches (cm)	Max Blind inches (cm)	Min Blind inches (cm)	Max Blind inches (cm)
		Traditions® Wood Blinds								
Traditions 2" (5.1 cm) Wood Blinds	B	12 (30.5)	84 (213.4)	12 (30.5)	86 (218.5)	12 (30.5)	84 (213.4)	120 (304.8)	12 (30.5)	86 (218.5)
Traditions 2" (5.1 cm) Barnwood and Distressed Wood Blinds	D	12 (30.5)	84 (213.4)	12 (30.5)	86 (218.5)	12 (30.5)	84 (213.4)	120 (304.8)	12 (30.5)	86 (218.5)
Traditions 2½" (6.1 cm) Wood Blinds	C	12 (30.5)	84 (213.4)	12 (30.5)	86 (218.5)	12 (30.5)	84 (213.4)	120 (304.8)	12 (30.5)	86 (218.5)
Elite Wood Blinds										
Elite 2" (5.1 cm) Wood Blinds	E	12 (30.5)	84 (213.4)	12 (30.5)	86 (218.5)	12 (30.5)	84 (213.4)	120 (304.8)	12 (30.5)	86 (218.5)
Elite 2" (5.1 cm) Authentic Hardwood Blinds**	G	12 (30.5)	84 (213.4)	12 (30.5)	78 (198.2)	12 (30.5)	84 (213.4)	120 (304.8)	12 (30.5)	78 (198.2)
Elite 2½" (6.1 cm) Wood Blinds	F	12 (30.5)	84 (213.4)	12 (30.5)	86 (218.5)	12 (30.5)	84 (213.4)	120 (304.8)	12 (30.5)	86 (218.5)
Traditions Composite Blinds										
Traditions 2" (5.1 cm) Composite Blinds	K	12 (30.5)	66 (167.7)	12 (30.5)	72 (182.9)	12 (30.5)	66 (167.7)	120 (304.8)	12 (30.5)	72 (182.9)
Traditions 2½" (6.4 cm) Composite Blinds	L	12 (30.5)	66 (167.7)	12 (30.5)	72 (182.9)	12 (30.5)	66 (167.7)	120 (304.8)	12 (30.5)	72 (182.9)
Lake Forest® Premium Faux Wood and Faux Wood Blinds										
Lake Forest 2" (5.1 cm) Premium Faux Wood Blinds	M	12 (30.5)	63 (160.1)	12 (30.5)	72 (182.9)	12 (30.5)	63 (160.1)	120 (304.8)	12 (30.5)	72 (182.9)
Lake Forest 2" (5.1 cm) Faux Wood Blinds	O	12 (30.5)	63 (160.1)	12 (30.5)	72 (182.9)	12 (30.5)	63 (160.1)	120 (304.8)	12 (30.5)	72 (182.9)
Lake Forest 2½" (6.4 cm) Premium Faux Wood Blinds	N	12 (30.5)	63 (160.1)	12 (30.5)	72 (182.9)	12 (30.5)	63 (160.1)	120 (304.8)	12 (30.5)	72 (182.9)
Lake Forest 2½" (6.4 cm) Faux Wood Blinds	P	12 (30.5)	63 (160.1)	12 (30.5)	72 (182.9)	12 (30.5)	63 (160.1)	120 (304.8)	12 (30.5)	72 (182.9)

**Walnut maximum height 68" (172.8 cm).

Depth Requirements for Inside Mount

Blind Type	Headrail Dimensions inches (cm)	Minimum Depth Mount inches (cm)	Flush with Casing (without valance)*	
			Cord Tilt inches (cm)	Wand Tilt inches (cm)
Traditions 2" (5.1 cm) and 2½" (6.1 cm) Wood Blinds Elite 2" (5.1 cm) and 2½" (6.1 cm) Wood Blinds Traditions 2" (5.1 cm) and 2½" (6.4 cm) Composite Blinds Lake Forest 2" (5.1 cm) and 2½" (6.4 cm) Premium Faux Wood and Faux Wood Blinds	2 x 2¼ (5.1 x 5.8)	¾ (2.0)	2⅝ (6.6)	2¾ (7.0)

*For measurements of fully recessed headrails with a valance, see valance options.

Options

Blind Options (for surcharges and pricing refer to pricing section)

Blind Options	Traditions® 1" (2.6 cm) Wood	Traditions 2" (5.1 cm) Wood and 2" (5.1 cm) Elite Wood	Traditions 2 3/8" (6.1 cm) Wood and 2 3/8" (6.1 cm) Elite Wood	Traditions 2" (5.1 cm) and 2 1/2" (6.4 cm) Composite	Lake Forest® 2" (5.1 cm) Premium Faux Wood and 2" (5.1 cm) Faux Wood	Lake Forest 2 1/2" (6.4 cm) Premium Faux Wood and 2 1/2" (6.4 cm) Faux Wood	Details
Accent Color (valance/bottomrail)		•^	•^				See the accent color section
Bay and Corner Windows	•	•	•	•	•	•	See the options section for measuring and ordering information
Cloth Tapes		• [§]	• [§]	• [§]	• [§]	• [§]	See the options section
Control Locations							Must be requested at time of order
• Tilt Left, Lift Right (standard)	•	•	•	•	•	•	
• Tilt Right, Lift Left	•	•	•	•	•	•	
• All Controls Right/ All Controls Left	•	•	•	•	•	•	
Cord Tilt		•	•	•	•	•	Color coordinated
Cordless Lift		• [§]	• [§]	• [§]	• [§]	• [§]	See price charts for surcharge
Custom Color		• ^{§^}	• ^{§^}				See pricing and option pricing section
Cut-Outs ¹	• [§]	• [§]	• [§]	• [§]	• [§]	• [§]	See the options section
Decorative Tassels	• [§]	• ^{§§}	• ^{§§}				See the options section
Hold Down Brackets	•	•	•	•	•	•	Must be requested at time of order
Motorized Tilt		• [§]	• [§]	• [§]			See the motorization price list
Multiple Blinds on One Headrail: 2 or 3 on 1 to left of solid line*	• [§]	• [§]	• [§]	• [§]	• [§]	• [§]	See the options section
NoHoles™ ¹		•	•	•	•	•	No charge option
Projection Brackets							Projection brackets not available for inside mount; must be requested at time of order; shims are standard on 2 3/8" (6.1 cm) and 2 1/2" (6.4 cm) blinds (outside mount)
• 2 3/8" (7.0 cm) and 4 3/4" (12.1 cm) Projection Brackets	•	•	•	•	•	•	
• 3/16" (0.5 cm) Shims	• ⁺	•	•	•	•	•	
Ring Pull	•	•	•	•	•	•	
Ring Tilt	•	•		• ^{^^}	•		
Sky Pole ¹							Available with ring tilt/ring pull only; must be requested at time of order
• 6 foot (1.9 m) pole	• [§]	• [§]	• [§]	• [§]	• [§]	• [§]	
• 9 foot (2.8 m) pole							
Wand Tilt	•	•	•	•	•	•	Color coordinated
Wood Cornices	• [§]	• [§]	• [§]	• [§]	• [§]	• [§]	See cornices and valances price list

*See solid line on appropriate price grid.

¹Not available with cordless lift option.

⁺3/8" (1.0 cm) projection block available.

[§]Option available with surcharge.

^{§§}Option available with surcharge for wood; no charge for elite wood.

[^]Available with elite wood only.

^{^^}Not available with 2 1/2" (6.4 cm) composite.

Options

Cordless Lift



- **For surcharge, see price charts**
- Available on wood, composite, and faux wood blinds (not available on 1" (2.6 cm) wood)
- Cordless lift blinds offer a safer alternative for homes with children and pets
- Tilt options available: Wand tilt eliminates dangling cords and is the safest option (maximum wand length is 48" (122 cm)); cord tilt is also available
- Easy to use: to lower blind, pull down; to raise, simply guide the blind into the desired location by gently lifting the bottomrail
- Not available with NoHoles™, cut-outs, or specialty shapes
- Legacy, craftsman, or symphony valances recommended with cordless lift blinds for better headrail coverage

	Wood	Composite	Faux Wood
Minimum Width inches (cm)	12 (30.5)	12 (30.5)	12 (30.5)
Maximum Single Blind Width inches (cm)	84 (213.4)	66 (167.7)	63 (160.1)
Maximum Multiple Blinds on One Headrail inches (cm)	120 (304.8)	120 (304.8)	120 (304.8)
Minimum Height inches (cm)	12 (30.5)	12 (30.5)	12 (30.5)
Maximum Height inches (cm)	86 (218.5)*	72 (182.9)	72 (182.9)
Maximum Square Footage square feet (square meters)	50 (127.0)	29 (73.7)	31.5 (80.1)

*78" (198.2 cm) for authentic hardwood Cherry and Maple, 68" (172.8 cm) for Walnut.

Motorized Tilt



See motorization price list for size specifications, options, and surcharges

- Available on 2" (5.1 cm) and 2¾" (6.1 cm) wood blinds and 2" (5.1 cm) and 2½" (6.4 cm) composite blinds
- Motorization will only tilt slats; raising or lowering blind is manual lift
- Blinds can be operated from virtually anywhere in the home
- Provides easy operation of hard-to-reach or large blinds
- Efficiently manages energy (heat gain and loss)
- Tilt slats on groups of multiple blinds simultaneously or individually
- Easily integrated with home automation systems
- Low voltage motorization requires no costly electrical hardwiring
- Motor located on the left side within the headrail; lift is on the right side
- Not available with multiple blinds on one headrail, specialty shapes, or hold down brackets
- Available with multiple power and control options

NOTE: Motorization components and accessories have a five-year limited warranty; excludes batteries.

Options

Multiple Blinds on One Headrail

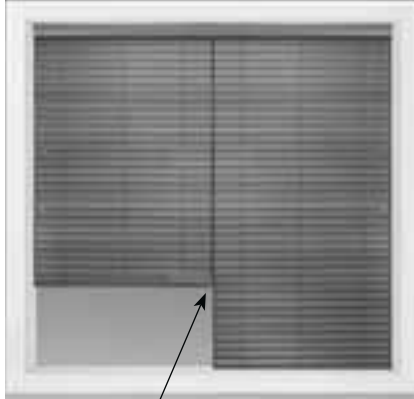

Gap 1/4" (.07 cm)

- **Surcharge: blinds to the left of the solid line on the price charts**
- **No charge: blinds to the right of the solid line on the price charts**
- Two or more blinds can be installed on a single headrail to provide a practical treatment for larger windows or sliding patio doors
- Due to weight limitations, some blinds must be manufactured as two or three blinds on one headrail

Multiple Blinds	Control Cord Locations	Gap inches (cm)
Cord Lift		
Two-On-One Headrail	Left panel: Left lift only and tilt left or tilt right* Right panel: Right lift only and tilt left or tilt right*	1/4 (0.7) (1/2 (1.3) on NoHoles™)
Cordless Lift		
Two-On-One Headrail	Left panel (tilt left) Right panel (tilt right)	1/4 (0.7)
Three-On-One Headrail	Left panel (tilt left) Right panel (tilt right) Center panel (tilt left)	1/4 (0.7)

*2" (5.1 cm) and 2½" (6.4 cm) premium faux wood and faux wood cannot have same side controls.

NOTE: Optional control locations may be requested.

Measuring

1. Measure overall width of the area to be covered. If space permits, an overlap of 1½" (3.9 cm) per side is recommended for outside mounts.
2. Measure the width of the area each blind is to cover. Measure and specify the left blind first, continuing to the right. Allow a minimum of ¼" (0.7 cm) between blinds for operating clearance.
3. Total width of all blinds, plus clearance(s), must equal overall width.
4. Measure height as follows:
 - a. For windows, use standard inside or outside measuring procedures.
 - b. For patio doors, measure height within ¾" (2.0 cm) of floor, either from ceiling or a point at least 6½" (16.6 cm) above the door frame. Check slat count table to see if blind will completely clear the doorway.

Ordering

1. Indicate whether two or three blinds are to be mounted on one headrail.
2. Specify total width of headrail.
3. Indicate each panel width separately, specify left blind first, continuing to the right.
4. Specify control positions.
5. Add appropriate surcharge, if to the left of the solid line on the price chart.

Options

NoHoles™



- **No charge**
- The design of the NoHoles option eliminates route holes, providing maximum privacy and the best available light control
- Cleaning is simplified by sliding the NoHoles slats out and wiping clean, or keeping the slats in place and vacuuming using a soft brush attachment
- Not available on 1" (2.6 cm) wood, blinds with cloth tapes, cordless lift, or specialty shapes
- Best suited for inside mount applications due to the slight shifting of slats during operation

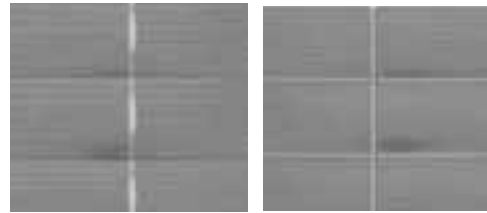

Standard

NoHoles

Cut-Out Blinds

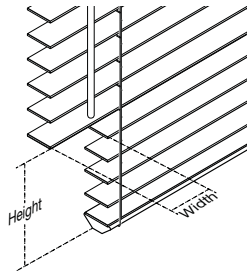

- **For surcharge, see options pricing**
- Maximum cut-out is 1" (2.6 cm) before route hole or NoHoles notch (corner and side cut-outs only)
- Cut-outs are measured with the slats tilted in the closed position for maximum clearance
- The cut-out height may be larger than requested due to slat placement
- Measure height from the bottom of the window up to the desired location
- Not available with cordless lift and wood vertical blinds

NOTE: Standard lead time does not apply for this feature. Additional manufacturing time is required.

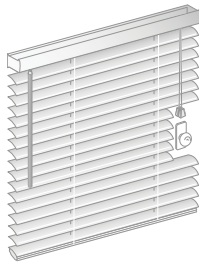

Side Cut-Out

Control Lengths for Cords and Wands

Finished Blind Height inches (cm)	Wand Length* inches (cm)	Cord Length
up to 36 (91.4)	12 (30.5)	1/3 of blind height
36 1/16 to 60 (91.6 to 152.4)	20 (50.8)	
60 1/16 to 70 (152.6 to 177.8)	30 (76.2)	
70 1/16 to 80 (178.0 to 203.2)	40 (101.6)	
80 1/16 to 90 (203.4 to 228.6)	48 (122.0)	
90 1/16 to 100 (228.8 to 254.0)	60 (152.4)	
100 1/16 to 120 (254.2 to 304.8)	72 (182.9)	

*Wands over 48" (122.0 cm) long are a clear plastic.

NOTE: Above control lengths may not fit your control needs based on window location or operator. Special length cords and wands may be requested at the time of ordering.

Options

Bay and Corner Windows

- Made as individual blinds to fit in bay or corner windows
- Each blind is on an individual headrail and has its own control
- Indicate each blind with bypass or butt; bypass is the blind mounted into the corner; butt is the blind butted up to the other blind; must provide blind location (left and right blind)
- Control locations can be on the right or left side of each blind; placing controls opposite the corner is recommended
- Depending on the angle, some corner blinds cannot be raised to the same height

- Manufacturer will take appropriate deductions for proper fit
- No additional charge
- Valances will be mitered in the corner for finished look
- Cornices and wood verticals are not available on bay or corner windows
- Slat alignment cannot be guaranteed on side by side blinds
- If you do not want manufacturer to take deductions DO NOT order as bay or corner

NOTE: Standard lead time does not apply for this feature. Additional manufacturing time is required.

Measuring Information

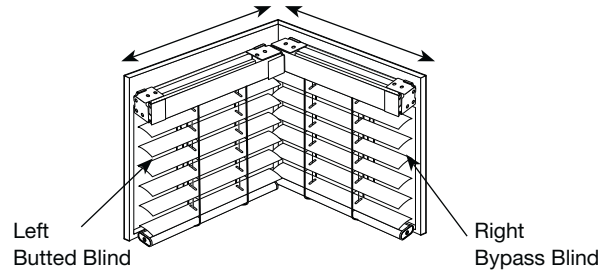
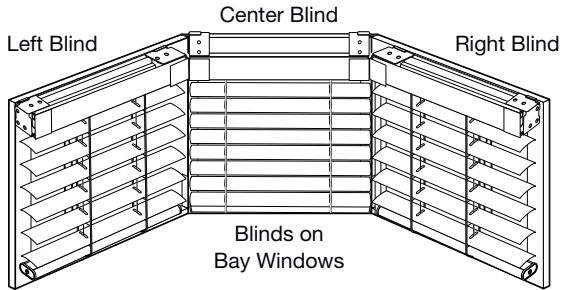

Corner Window

Measure:

Width of each window from corner to the point you would like to cover.

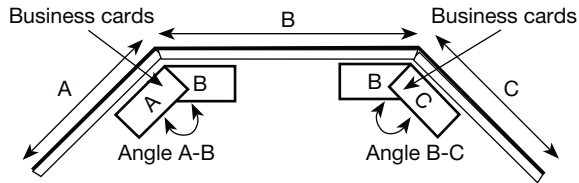

Three-Sided Bay Window

Measure:

A and C: Width of side windows from the corners to the point you would like the blind to cover.

B: Width of the center window from corner to corner.

Angle A-B: Angle between windows (A) and (B).

Angle B-C: Angle between windows (B) and (C).

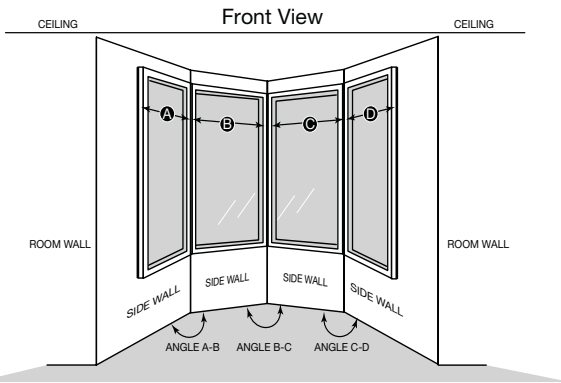

Four-Sided Bay Window

Measure:

A and D: Width of side windows from the corners to the point you would like the blind to cover.

B and C: Width of each window from corner to corner.

Angle A-B: Angle between windows (A) and (B).

Angle B-C: Angle between windows (B) and (C).

Angle C-D: Angle between windows (C) and (D).

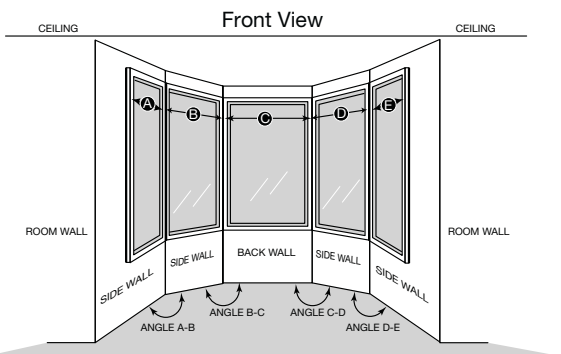

Five-Sided Bay Window

Measure:

A and E: Width of side windows from the corners to the point you would like the blind to cover.

B, C, and D: Width of each center window from corner to corner.

Angle A-B: Angle between windows (A) and (B).

Angle B-C: Angle between windows (B) and (C).

Angle C-D: Angle between windows (C) and (D).

Angle D-E: Angle between windows (D) and (E).

NOTE: Measure bay angle using protractor or angle finder, or use two business cards in bay corner as illustrated above, trace onto paper and fax to customer service.

Options

Cloth Tapes



- For surcharge, see price charts
- Decorative option to add to wood, composite, or faux wood blinds
- Decorative tapes will have pattern visible to room side only
- Not available with 1" (2.6 cm) wood, NoHoles™ option, or specialty shapes
- See chart below for availability of colors

Color Name	Color Number	Backer Tape Color	Traditions® 2" (5.1 cm) Wood Elite 2" (5.1 cm) Wood Traditions 2" (5.1 cm) Composite Lake Forest® 2" (5.1 cm) Premium Faux Wood Lake Forest 2" (5.1 cm) Faux Wood	Traditions® 2 3/8" (6.1 cm) Wood Elite 2 3/8" (6.1 cm) Wood Traditions 2 1/2" (6.4 cm) Composite Lake Forest® 2 1/2" (6.4 cm) Premium Faux Wood Lake Forest 2 1/2" (6.4 cm) Faux Wood
1" (2.6 cm) Solid Tapes			Cloth Tapes (available as marked)	
Beige	1011		•	
Black	1033		•	
Cocoa	1297		•	
Duck White	1136		•	
Toffee	1296		•	
White Smoke	1617		•	
1 1/2" (3.9 cm) Solid Tapes				
Aztec Amber	2177		•	•
Beige	2011		•	•
Black	2033		•	•
Chocolate	2353		•	•
Cocoa	2297		•	•
Dark Grey	2857		•	•
Duck White	2136		•	•
Golden Honey	2176		•	•
Light Grey	2861		•	•
Moss	2500		•	•
Navy	2369		•	•
Shadow Grey	2178		•	•
Taupe	2659		•	•
Toffee	2296		•	•
White	2005		•	•
White Smoke	2617		•	•
1 1/2" (3.9 cm) Decorative Tapes				
Arctic Sky	S164	Duck White	•	
Belgian Cream	Q164	Duck White	•	
Coastal Fog	C159	Duck White	•	
Creamy Taupe	D147	Duck White	•	
Dew Alabaster	N112	Duck White	•	
Fairweather Blue	D155	Duck White	•	
Fresh Sage	B160	Duck White	•	
Medallion Flax	F541	Light Beige	•	
Medallion Taupe	F659	Taupe	•	
Medallion Toffee	F296	Black	•	
Modern Taupe	C157	Duck White	•	
Natural Linen	S166	Taupe	•	
Neutral Intrigue	B161	Duck White	•	
Palm Beach	P179	White Smoke	•	
Variiegated Taupe	Q659	Taupe	•	

Options

Decorative Tassels (wood blinds only)



Standard Tassel

1" (2.6 cm) wood tassel stained or painted to coordinate with your wood blinds.



Brass Tassel

1" (2.6 cm) antique brass tassel ideal for medium and dark stains and paints.

No charge for elite blinds.



Nickel Tassel

1" (2.6 cm) nickel tassel ideal for light stains and paints.

No charge for elite blinds.



Carved Tassel

1" (2.6 cm) carved wood tassel stained or painted to coordinate with your wood blinds.

No charge for elite blinds (not available on authentic hardwoods).



Flared Tassel

2¼" (5.8 cm) long, genuine hardwood tassel stained or painted to coordinate with your wood blinds.

No charge for elite blinds (not available on authentic hardwoods).



Ovate Tassel

2¼" (5.8 cm) long, genuine hardwood tassel stained or painted to coordinate with your wood blinds.

No charge for elite blinds (not available on authentic hardwoods).

NOTE: For surcharges see options pricing.

Accent Color (elite wood blinds only)

For surcharge, see options pricing.

Complement the window and décor of the room by specifying a different color valance and bottomrail. Single color only.

Custom Color

For surcharge, see options pricing.

Graber® offers the unique option of custom color either paint or stain. Use the following guidelines when placing your order:

1. Complete the custom color match request form. Forms can be found on graberdirect.com.
2. Supply Springs Window Fashions with a color sample labeled with the color name and purchase order number. The sample needs to be at least 2" (5.1 cm) x 2" (5.1 cm). For best results, submit a 3" (7.7 cm) x 3" (7.7 cm) color sample.
3. Send the order, along with the request form and color sample to: Springs Window Fashions, LLC
ATTN: Graber Custom Color
33 West 3rd Street, Suite 400
Williamsport, PA 17701
4. Approval of the custom color sample is required on orders of six or more blinds. A sample of the custom color will be sent upon request for orders of less than six blinds. If a custom color sample is not requested, the sample provided will be used to manufacture the wood blinds. If the color sample is to be returned, please note this on your order.
5. Custom color samples will be sent for approval approximately two weeks after receiving the original color sample.
6. Once approval is received, fabrication of the custom color blinds will begin.

Why Elite Wood for Your Client's Home

Elite wood blinds are individually hand finished using a wiping technique to enhance the beauty of the wood and create a truly beautiful blind as unique as your client.

Additional benefits of elite wood blinds include:

- Each wood component is finished after being cut and routed for the client's individual blind—creating wood components that are completely sealed from the environment
- Elite wood finish is applied using a wiping process rather than flow coating the finish; the end result is a finish that further enhances the beautiful characteristics of the wood
- All Graber Traditions® paints and stains are available using this unique finishing style, or create a completely customized blind using the custom color option

How to Order Elite Wood: Special Ordering Instructions



On graberdirect.com

- Select the description elite wood
- Select the finish choice
 - Elite finish
 - Elite high gloss
 - Sandblast finish (2" (5.1 cm) only)
- Follow the remaining ordering instructions to complete the order

NOTE: Due to the nature of the elite process, blinds and specialty shapes require an extended lead time. Lead times vary depending on blind sizes and quantities.

Options

Valance Options

Valance Type	Blind Type	Maximum Continuous Width*		Control Type	Standard Valance Returns inches (cm)	Full Recess Depth inches (cm)
		Inside Mount No Returns inches (cm)	Inside Mount with Returns inches (cm)			
2½" (6.4 cm) Classic Valance  Valance Returns ½" (1.3 cm) to 1" (2.6 cm): glued 1⅛" (2.7 cm) to 4⅝" (11.8 cm): optional glued 4⅞" (12.0 cm) and greater: not glued	2" (5.1 cm) Barnwood [^]	100¼ (254.7)	98⅞ (249.9)	Cord tilt	2⅞ (7.4)	3¼ (8.3)
				Wand tilt	3⅞ (9.1)	3⅞ (9.9)
				Cordless wand tilt	3⅞ (8.6)	3⅞ (9.6)
				Cordless cord tilt	2¾ (7.0)	3⅞ (7.8)
3" (7.7 cm) Classic Valance  Valance Returns ½" (1.3 cm) to 1" (2.6 cm): glued 1⅛" (2.7 cm) to 4⅝" (11.8 cm): optional glued 4⅞" (12.0 cm) and greater: not glued	1" (2.6 cm) Wood	100¼ (254.7)	98⅞ (249.9)	Wand tilt	2⅞ (5.3)	2⅞ (6.1)
	2" (5.1 cm) Wood 2" (5.1 cm) Elite Wood	100¼ (254.7)	98⅞ (249.9)	Cord tilt	2⅞ (7.4)	3¼ (8.3)
				Wand tilt	3⅞ (9.1)	3⅞ (9.9)
				Cordless wand tilt	3⅞ (8.6)	3⅞ (9.6)
				Cordless cord tilt	2¾ (7.0)	3⅞ (7.8)
	2⅝" (6.1 cm) Wood 2⅝" (6.1 cm) Elite Wood	100¼ (254.7)	98⅞ (249.9)	Cord tilt	3⅞ (9.6)	4⅞ (10.4)
				Wand tilt	3⅞ (9.6)	4⅞ (10.4)
				Cordless wand tilt	3⅞ (9.1)	3⅞ (10.1)
				Cordless cord tilt	3⅞ (9.1)	3⅞ (10.1)
	Wood Verticals	100¼ (254.7)	98⅞ (249.9)	N/A	5½ (14.0)	5⅞ (14.8)
	2" (5.1 cm) Composite [^]	106⅞ (270.9)	105⅞ (267.7)	Cord tilt	2⅞ (7.4)	3¼ (8.3)
				Wand tilt	3⅞ (9.1)	3⅞ (9.9)
				Cordless wand tilt	3⅞ (8.6)	3⅞ (9.6)
				Cordless cord tilt	2¾ (7.0)	3⅞ (7.8)
				Cord tilt	3⅞ (10.1)	4¼ (10.8)
				Wand tilt	3⅞ (10.1)	4¼ (10.8)
2½" (6.4 cm) Composite [^]	106⅞ (270.9)	105⅞ (267.7)	Cordless wand tilt	3⅞ (9.6)	4⅞ (10.5)	
			Cordless cord tilt	3⅞ (9.6)	4⅞ (10.5)	
			Cord tilt	2⅞ (7.4)	3¼ (8.3)	
			Wand tilt	3⅞ (9.1)	3⅞ (9.9)	
2" (5.1 cm) Premium Faux Wood [^] 2" (5.1 cm) Faux Wood [^]	106⅞ (270.9)	105⅞ (267.7)	Cordless wand tilt	3⅞ (8.6)	3⅞ (9.6)	
			Cordless cord tilt	2¾ (7.0)	3⅞ (7.8)	
			Cord tilt	3⅞ (10.1)	4¼ (10.8)	
			Wand tilt	3⅞ (10.1)	4¼ (10.8)	
2½" (6.4 cm) Premium Faux Wood [^] 2½" (6.4 cm) Faux Wood [^]	106⅞ (270.9)	105⅞ (267.7)	Cordless wand tilt	3⅞ (9.6)	4⅞ (10.5)	
			Cordless cord tilt	3⅞ (9.6)	4⅞ (10.5)	
			Cord tilt	3⅞ (10.1)	4¼ (10.8)	
			Wand tilt	3⅞ (10.1)	4¼ (10.8)	
3" (7.7 cm) Majestic Valance  Valance Returns ½" (1.3 cm) to 1" (2.6 cm): glued 1⅛" (2.7 cm) to 4⅝" (11.8 cm): optional glued 4⅞" (12.0 cm) and greater: not glued	2" (5.1 cm) Composite [^]	106⅞ (270.9)	105⅞ (267.7)	Cord tilt	2⅞ (7.4)	3⅞ (8.6)
				Wand tilt	3⅞ (9.1)	4⅞ (10.4)
				Cordless wand tilt	3⅞ (8.6)	3⅞ (9.9)
				Cordless cord tilt	2¾ (7.0)	3⅞ (8.1)
	2½" (6.4 cm) Composite [^]	106⅞ (270.9)	105⅞ (267.7)	Cord tilt	3⅞ (10.1)	4⅞ (11.3)
				Wand tilt	3⅞ (10.1)	4⅞ (11.3)
				Cordless wand tilt	3⅞ (9.6)	4¼ (10.8)
				Cordless cord tilt	3⅞ (9.6)	4¼ (10.8)
	2" (5.1 cm) Premium Faux Wood [^] 2" (5.1 cm) Faux Wood [^]	106⅞ (270.9)	105⅞ (267.7)	Cord tilt	2⅞ (7.4)	3⅞ (8.6)
				Wand tilt	3⅞ (9.1)	4⅞ (10.4)
				Cordless wand tilt	3⅞ (8.6)	3⅞ (9.9)
				Cordless cord tilt	2¾ (7.0)	3⅞ (8.1)
2½" (6.4 cm) Premium Faux Wood [^] 2½" (6.4 cm) Faux Wood [^]	106⅞ (270.9)	105⅞ (267.7)	Cord tilt	3⅞ (10.1)	4⅞ (11.3)	
			Wand tilt	3⅞ (10.1)	4⅞ (11.3)	
			Cordless wand tilt	3⅞ (9.6)	4¼ (10.8)	
			Cordless cord tilt	3⅞ (9.6)	4¼ (10.8)	



*Continuous valances wider than sizes shown above will have two or more sections spliced together with a keystone. Maximum width for spliced valances is 300¼" (764.0 cm).

[^]Keystones not available.

NOTE: For replacement valances see cornices and valances price list.

Options

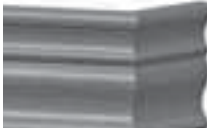
Valance Options

Valance Type	Blind Type	Maximum Continuous Width*		Control Type	Standard Valance Returns inches (cm)	Full Recess Depth inches (cm)
		Inside Mount No Returns inches (cm)	Inside Mount with Returns inches (cm)			
3½" (8.9 cm) Craftsman Valance  Valance Returns ½" (1.3 cm) to 1" (2.6 cm): glued 1⅞" (2.7 cm) to 4⅝" (11.8 cm): optional glued 4⅞" (12.0 cm) and greater: not glued	1" (2.6 cm) Wood	100¼ (254.7)	98⅞ (249.9)	Wand tilt	2⅞ (5.3)	2⅞ (6.1)
	2" (5.1 cm) Wood 2" (5.1 cm) Elite Wood	100¼ (254.7)	98⅞ (249.9)	Cord tilt Wand tilt Cordless wand tilt Cordless cord tilt	2⅞ (7.4) 3⅞ (9.1) 3⅞ (8.6) 2⅞ (7.0)	3¼ (8.3) 3⅞ (9.9) 3¼ (9.6) 3⅞ (7.8)
	2⅝" (6.1 cm) Wood 2⅝" (6.1 cm) Elite Wood	100¼ (254.7)	98⅞ (249.9)	Cord tilt Wand tilt Cordless wand tilt Cordless cord tilt	3⅞ (9.6) 3⅞ (9.6) 3⅞ (9.1) 3⅞ (9.1)	4⅞ (10.4) 4⅞ (10.4) 3⅞ (10.1) 3⅞ (10.1)
	Wood Verticals	100¼ (254.7)	98⅞ (249.9)	N/A	5½ (14.0)	5⅞ (14.8)
3½" (8.9 cm) Legacy Valance  Valance Returns ½" (1.3 cm) to 1" (2.6 cm): glued 1⅞" (2.7 cm) to 4⅝" (11.8 cm): optional glued 4⅞" (12.0 cm) and greater: not glued	1" (2.6 cm) Wood	100¼ (254.7)	98⅞ (249.9)	Wand tilt	2⅞ (5.3)	2⅞ (6.2)
	2" (5.1 cm) Wood 2" (5.1 cm) Elite Wood	100¼ (254.7)	98⅞ (249.9)	Cord tilt Wand tilt Cordless wand tilt Cordless cord tilt	2⅞ (7.4) 3⅞ (9.1) 3⅞ (8.6) 2⅞ (7.0)	3⅞ (8.5) 4 (10.2) 3⅞ (9.7) 3⅞ (8.0)
	2" (5.1 cm) Distressed Wood [^] 2" (5.1 cm) Elite Authentic Hardwood [^]	100¼ (254.7)	98⅞ (249.9)	Cord tilt Wand tilt Cordless wand tilt Cordless cord tilt	2⅞ (7.4) 3⅞ (9.1) 3⅞ (8.6) 2⅞ (7.0)	3⅞ (8.5) 4 (10.2) 3⅞ (9.7) 3⅞ (8.0)
	2⅝" (6.1 cm) Wood 2⅝" (6.1 cm) Elite Wood	100¼ (254.7)	98⅞ (249.9)	Cord tilt Wand tilt Cordless wand tilt Cordless cord tilt	3⅞ (9.6) 3⅞ (9.6) 3⅞ (9.1) 3⅞ (9.1)	4⅞ (10.7) 4⅞ (10.7) 4⅞ (10.4) 4⅞ (10.4)
	Wood Verticals	100¼ (254.7)	98⅞ (249.9)	N/A	5½ (14.0)	5⅞ (15.0)
4½" (11.5 cm) Symphony Valance  Valance Returns ½" (1.3 cm) to 1" (2.6 cm): glued 1⅞" (2.7 cm) to 4⅝" (11.8 cm): optional glued 4⅞" (12.0 cm) and greater: not glued	1" (2.6 cm) Wood	100¼ (254.7)	98⅞ (249.9)	Wand tilt	2⅞ (5.3)	2⅞ (7.2)
	2" (5.1 cm) Wood 2" (5.1 cm) Elite Wood	100¼ (254.7)	98⅞ (249.9)	Cord tilt Wand tilt Cordless wand tilt Cordless cord tilt	2⅞ (7.4) 3⅞ (9.1) 3⅞ (8.6) 2⅞ (7.0)	3⅞ (9.3) 4⅞ (11.0) 4⅞ (10.5) 3⅞ (8.9)
	2⅝" (6.1 cm) Wood 2⅝" (6.1 cm) Elite Wood	100¼ (254.7)	98⅞ (249.9)	Cord tilt Wand tilt Cordless wand tilt Cordless cord tilt	3⅞ (9.6) 3⅞ (9.6) 3⅞ (9.1) 3⅞ (9.1)	4⅞ (11.5) 4⅞ (11.5) 4⅞ (11.0) 4⅞ (11.0)
	Wood Verticals	100¼ (254.7)	98⅞ (249.9)	N/A	5½ (14.0)	6¼ (15.9)
5" (12.7 cm) Flat Valance 	2" (5.1 cm) Wood Specialty Shapes	N/A	N/A	Wand tilt Cord tilt	N/A N/A	3⅞ (9.9) 3⅞ (9.9)
	2⅝" (6.1 cm) Wood Specialty Shapes	N/A	N/A	Wand tilt Cord tilt	N/A N/A	3⅞ (9.9) 3⅞ (9.9)

*Continuous valances wider than sizes shown above will have two or more sections spliced together with a keystone. Maximum width for spliced valances is 300¾" (764.0 cm).

[^]Keystones not available.

NOTE: For replacement valances see cornices and valances price list.

Options

How to Measure for Valance Returns

Window depths vary considerably depending on the age and style of the window. **Always** measure the window depth, regardless of the type of window treatment the client is considering. Knowing the depth when the order is placed can help prevent costly errors.

Please use our valance return cards to assist in correctly calculating valance return sizes.

To calculate the return width, use this formula:

(standard return width) minus (client window depth) = special return width to order for inside mount blind

REMEMBER:

- Smallest return width is $\frac{1}{2}$ " (1.3 cm) (inside measurement), maximum return width is 8" (20.4 cm)
- Returns up to 1" (2.6 cm) (inside measurement) will be glued; $1\frac{1}{16}$ " (2.7 cm) to $4\frac{5}{8}$ " (11.8 cm) optional glued
- The width of a return and the width of a valance are measured on the inside (back side) of the valance, not the outside (face) of the valance (see diagram at right)
- Standard return size for $2\frac{3}{8}$ " (6.1 cm) blinds—subtract $\frac{3}{16}$ " (0.5 cm) prior to determining special return width
- Standard return size for $2\frac{1}{2}$ " (6.4 cm) blinds—subtract $\frac{3}{8}$ " (1.0 cm) prior to determining special return width

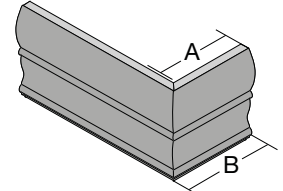

A: Inside Measurement
B: Outside Measurement

How to Measure and Order Valances

If a valance is ordered, it is supplied in one of the following styles, depending on how your blind will be mounted. For a more custom look, the valance and returns may be special ordered to your measurements.

NOTE: Valances with returns are measured and cut from the **INSIDE** of the miter to ensure the most accurate fit when installed over the headrail or window frame.

Blinds ordered as an OUTSIDE MOUNT

with requested returns will be supplied with returns sized to cover the end of the blind back to the mounting surface. If projection brackets are requested when the blind is ordered, longer returns will be sent automatically. Outside mount blinds are available without returns upon request.

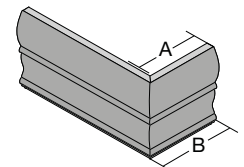
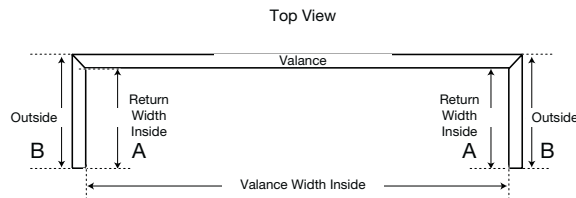

A: Inside Measurement
B: Outside Measurement

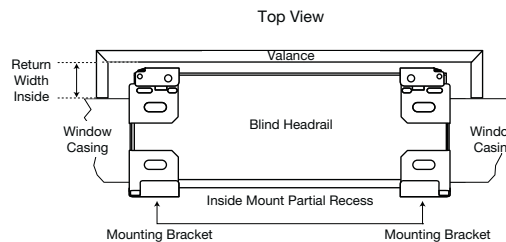

NOTE: Minimum return width is $\frac{1}{2}$ " (1.3 cm), maximum return width is 8" (20.4 cm).

Additional Ordering Information:

- Please state at the time of order if the valance and return measurements are for the **EXACT** size required so that no additions or deductions are made
- Different return sizes can be ordered for the same valance; always provide **LEFT** return **INSIDE** measurement first when ordering
- Valance projection is different if the blind has a wand tilt or cord tilt; please refer to the previous specifications chart for more information
- Returns up to 1" (2.6 cm) will be glued; $1\frac{1}{16}$ " (2.7 cm) to $4\frac{5}{8}$ " (11.8 cm) optional glued; $4\frac{11}{16}$ " (12.0 cm) and greater will not be glued
- Bay and corner blinds—must specify return width on inside mount at time of order
- Single side returns are available—opposite end will be cut straight

Options

Valance Keystone

- Decorative keystones are required on wood valances that require splicing
- Keystones will be equally spaced unless special splice locations are requested at time of order
- Optional keystones can be ordered with single piece valances, or in addition to required keystones at the time of order only
 - Minimum width with a keystone: 12" (30.5 cm)
 - Maximum number of keystones: 3
- Keystones will be stained or painted to match the valance ordered as standard; optional different color selection available
- Keystones not available on elite authentic hardwood, distressed wood, barnwood, in sandblast finish, composite, or faux wood valances
- Keystones cannot be ordered for existing valances, attachment will not work
- All inside mount applications will have a slight light gap at the top of valance when installed

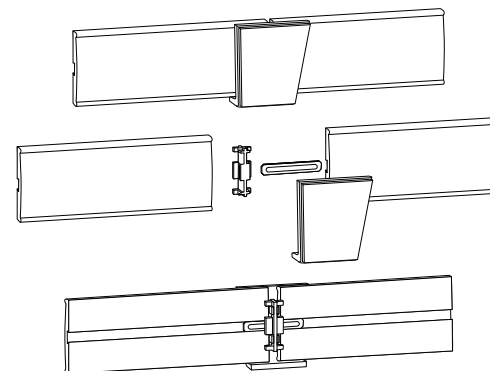

Splicing Requirements

Profile	Number of Sections	Number of Keystones	No Returns		With Returns (inside dimensions)	
			Minimum inches (cm)	Maximum inches (cm)	Minimum inches (cm)	Maximum inches (cm)
2½" (6.4 cm) Classic Barnwood Valance*	1	0	8 (20.4)	100¼ (254.7)	8 (20.4)	98⅞ (249.9)
3" (7.7 cm) Classic Wood Valance	2	1	100⅞ (254.8)	200½ (509.3)	98⅞ (250.1)	198⅞ (504.6)
3½" (8.9 cm) Craftsman Wood Valance						
3½" (8.9 cm) Legacy Wood Valance	3	2	200⅞ (509.5)	300¾ (764.0)	198⅞ (504.7)	298⅞ (759.2)
4½" (11.5 cm) Symphony Wood Valance						

*Keystones not available.

Outside Mount

- Wood valances requiring a splice will include a keystone (see chart above for details)

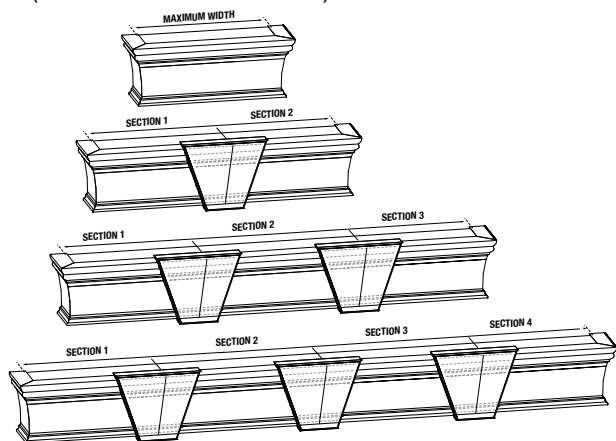

Inside Mount

- Wood valances 100¼" (254.7 cm) or wider will require a keystone

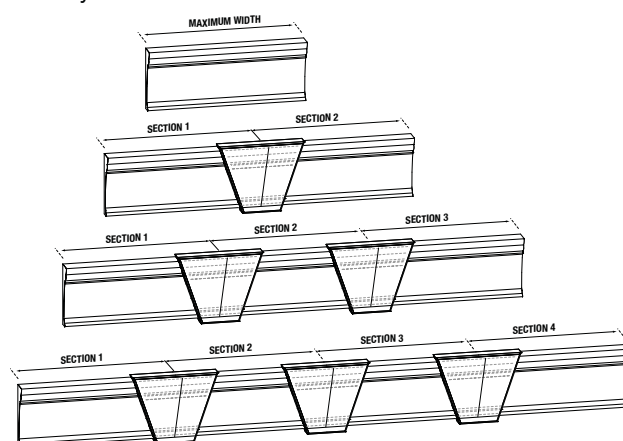

How to Measure a Special Splice Location

A keystone is supplied for valance widths that require a splice. Keystones will be equally spaced unless a special splice location is requested at time of order. The placement of the splice will be calculated by the factory using an **INSIDE** measurement from the mitered corner to the location specified on the order.

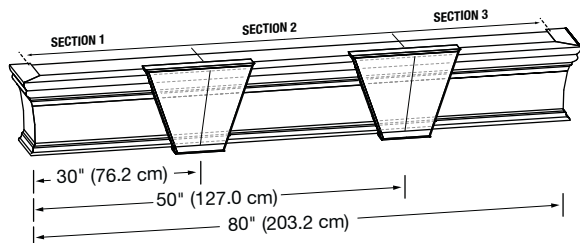

Each splice location should be recorded starting from the **LEFT BACKSIDE** corner.

These formulas are used to calculate BACKSIDE valance measurements.

Inside Mount with No Returns	Ordered width - ¼" (0.2 cm)
Inside Mount with Returns	Ordered width + ¼" (0.7 cm)
Outside Mount with No Returns	Ordered width + ½" (1.3 cm)
Outside Mount with Returns	Ordered width + ¾" (2.0 cm)

Example: Overall valance width = 80" (203.2 cm) backside measurement
 First splice from left = 30" (76.2 cm) backside measurement
 Second splice from left = 50" (127.0 cm) backside measurement

For surcharge, see options pricing.

NOTE: All measurements need to be from BACKSIDE.

Options

Wood Specialty Shapes: Incline Wire Blinds

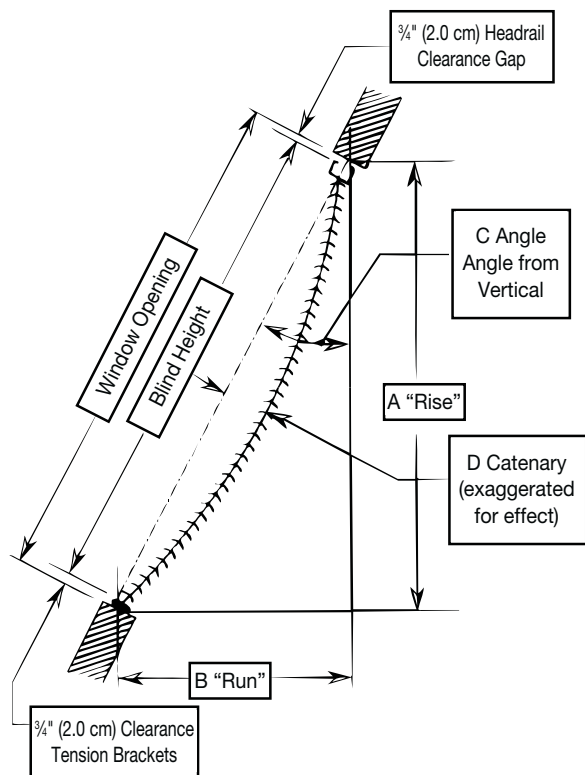

NOTE: Maximum degree from vertical is 45°.
Blinds over 30° will have marginal tilt.
Blinds over 40° will have marginal lowering.

- Blinds up to 60" (152.4 cm) will have 2 wires
- Blinds over 60" (152.4 cm) will have 4 wires

Options Available:

- Decorative tassels
- Ring tilt (2" (5.1 cm) only)
- Custom color
- High gloss finish
- Accent color

NOTE: Due to the nature of the elite process, specialty shapes require an extended lead time. Lead times vary depending on blind sizes and quantities.

Features

- For pricing, see options pricing
- Cord, wand, and ring tilt options available
- Wand control is the universal joint attachment
- Width less than 24" (61.0 cm) cannot have same side controls
- There is a turn buckle in the headrail for adjusting the tension in the wires
- At the bottomrail, there are sill plates that are used to attach the wires to the sill
- Color coordinated box style bracket

Incline (tension) Wire Blinds

- Rectangular blinds will tilt only; may be used in windows installed vertically to 45 degrees from vertically (maximum)
- Ideal for applications that require stabilized blinds, such as boats

- A. Rise—The vertical measurement from the top of a window to the RUN to form a 90 degree angle.
- B. Run—The horizontal measurement from the bottom of a window to the RISE to form a 90 degree angle.
- C. Angle—The degree the window is slanted perpendicular (at a right angle) to the floor.
- D. Catenary—The degree a blind may possibly bow. No measurement needed. Must give measurements for width and height. A and B are used to calculate the angle (must be less than 45°).

Measuring Information

Use regular measuring instructions; see measuring instructions tab. Available on elite wood blinds.

Size Considerations	Incline Wire inches (cm)	
Minimum Width	16 (40.7)	
Maximum Width	96 (243.9)	
Minimum Height	12 (30.5)	
Size Considerations	Blind Width inches (cm)	Max Height inches (cm)
Maximum Height	16 to 32 (40.7 to 81.3)	120 (304.8)
	32½ to 57 (81.6 to 144.8)	108 (274.4)
	57½ to 92 (145.1 to 233.7)	102 (259.1)
	92½ to 96 (234.0 to 243.9)	90 (228.6)

Depth Requirements	2" (5.1 cm) inches (cm)	2½" (6.1 cm) inches (cm)
Minimum	¾ (2.0)	¾ (2.0)
Flush with Casing	2¾ (6.1)	2¾ (6.1)

NOTE: Not available with cloth tapes, cordless lift, cut-outs, multiple blinds on one headrail, NoHoles™, or valances.

Slat alignment cannot be guaranteed on side by side blinds.

Options

Wood Specialty Shapes: Angle Top or Bottom

Features

- For pricing, see price charts
- Available in 2" (5.1 cm) and 2 3/8" (6.1 cm) slats
- Extruded aluminum headrail
 - 2 1/4" (5.8 cm) depth x 2" (5.1 cm) height

- Lightblocking headrail is not available
- See below for measuring guidelines
- Not available with cloth tapes, cordless lift, cut-outs, motorized tilt, NoHoles™, or unique finishes

Controls

- Cord and wand tilt options available
- Standard wood wand lengths are 12" (30.5 cm), 20" (50.8 cm), 30" (76.2 cm), 40" (101.6 cm), and 48" (122.0 cm)
- Polycarbonate wands available in lengths over 48" (122.0 cm)
- Universal joint attachments for wand control
- Wand and cord tilt controls will be approximately one third the length of the blind; controls on angle top or angle bottom blinds will be located on the short side of the blind
- Due to the angle of the headrail, blinds may not operate as smoothly as a standard blind
- Maximum angle is 45°
- Blinds have tilt function only

Size Considerations	2" (5.1 cm) inches (cm)	2 3/8" (6.1 cm) inches (cm)
Minimum Width	15 (38.1)	15 (38.1)
Minimum Height*	12 (30.5)	12 (30.5)
Maximum Width	96 (243.9)	96 (243.9)
Maximum Height	120 (304.8)	120 (304.8)

*Long side.

Depth Requirements	2" (5.1 cm) inches (cm)	2 3/8" (6.1 cm) inches (cm)
Minimum	3/4 (2.0)	3/4 (2.0)
Flush with Casing	3 3/8 (9.9)	3 3/8 (9.9)

Mounting Options

- Blinds under 24" (61.0 cm) must use hold down brackets to ensure level installation

NOTE: Due to the nature of the elite process, specialty shapes require an extended lead time. Lead times vary depending on blind sizes and quantities.

Valance



5" (12.7 cm) Flat Valance

- Valance returns are not available

Angle Top or Bottom: Measuring Guidelines

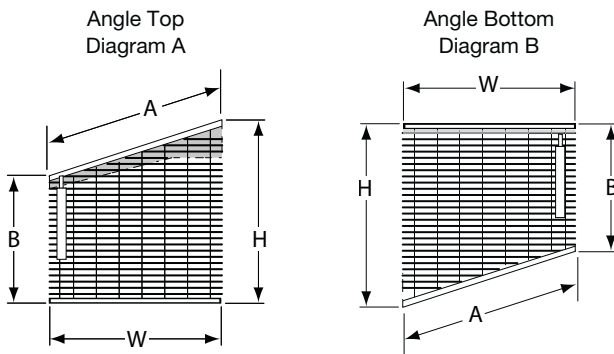

Refer to diagrams for illustrations of measurements to include when ordering an angle top or angle bottom blind.

Also specify/include:

- Inside or outside mount

W: Straight width

B: Length of short side

H: Length of long side

A: Angle width

Options

Wood Specialty Shapes: Trapezoid, Triangle, and Octagon

Features

- For pricing, see price charts
- Available in 2" (5.1 cm) and 2½" (6.1 cm) slats
- Extruded aluminum headrail
 - 2¼" (5.8 cm) depth x 2" (5.1 cm) height

Controls

- Cord and wand tilt options available
- Standard wood wand lengths are 12" (30.5 cm), 20" (50.8 cm), 30" (76.2 cm), 40" (101.6 cm), and 48" (122.0 cm)
- Polycarbonate wands available in lengths over 48" (122.0 cm)
- Universal joint attachments for wand control
- Wand and cord tilt controls will be approximately one third the length of the blind
- Due to the angle of the headrail, blinds may not operate as smoothly as a standard blind
- Blinds have tilt function only

Mounting Options

- All shapes receive predrilled openings and fasteners for direct mounting
 - Inside mounts: predrilled openings are located on the underside of the headrail
 - Outside mounts: predrilled openings are located on the front and back face of the headrail

NOTE: Due to the nature of the elite process, specialty shapes require an extended lead time. Lead times vary depending on blind sizes and quantities.

- Lightblocking headrail is not available
- See below for measuring guidelines
- Not available with cloth tapes, cordless lift, cut-outs, motorized tilt, NoHoles™, or unique finishes

Size Considerations	2" (5.1 cm) inches (cm)	2½" (6.1 cm) inches (cm)
Minimum Width**	15 (38.1)	15 (38.1)
Minimum Height	12 (30.5)	12 (30.5)
Maximum Width	96 (243.9)	96 (243.9)
Maximum Height	120 (304.8)	120 (304.8)

**Octagon and trapezoid: 7½" (19.1 cm) exact minimum for top headrail.

Depth Requirements	2" (5.1 cm) inches (cm)	2½" (6.1 cm) inches (cm)
Minimum	2¼ (5.8)	2¾ (6.1)
Flush with Casing	3⅞ (9.9)	3⅞ (9.9)

Valance



5" (12.7 cm) Flat Valance

- Valance returns are not available

Trapezoid, Triangle, or Octagon: Measuring Guidelines

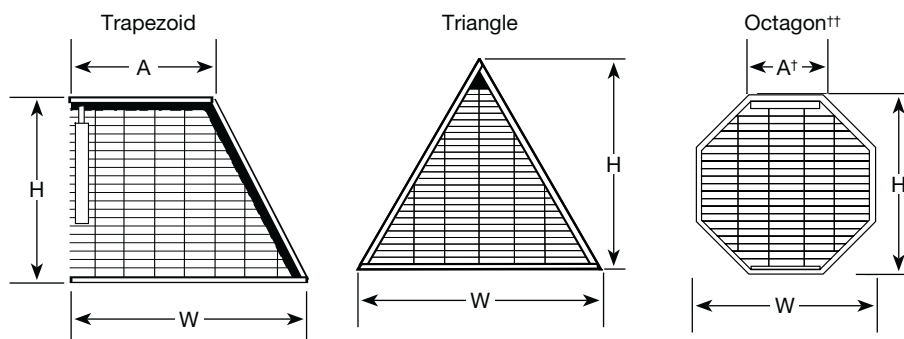

†Verify each section width.

††Depending on sizes, octagon may be framed on all sides. Contact customer service.

Refer to diagrams for illustrations of measurements to include when ordering a trapezoid, triangle, or octagon blind.

W: Bottom width

H: Length of long side

A: Top width

Also specify/include:

- Inside or outside mount
- Control location

Options

Wood Specialty Shapes: Arched Blinds

Features

- For pricing, see price charts
- Available in 2" (5.1 cm) and 2 3/8" (6.1 cm) slats
- Extruded aluminum headrail
 - 2 1/4" (5.8 cm) depth x 2" (5.1 cm) height

- Lightblocking headrail is not available
- See below for measuring guidelines
- Not available with cloth tapes, cordless lift, cut-outs, motorized tilt, NoHoles™, or unique finishes

Controls

- Cord and wand tilt options available
- Standard wood wand lengths are 12" (30.5 cm), 20" (50.8 cm), 30" (76.2 cm), 40" (101.6 cm), and 48" (122.0 cm)
- Polycarbonate wands available in lengths over 48" (122.0 cm)
- Arched blinds will fully tilt but will not lift
- Universal joint attachments for wand control
- Wand and cord tilt controls will be approximately one third the length of the blind; controls on arched blinds will be located on the low side of the quarter arch
- Due to the angle of the headrail, blinds may not operate as smoothly as a standard blind
- Blinds have tilt function only

	2" (5.1 cm) inches (cm)	2 3/8" (6.1 cm) inches (cm)
Minimum Arch Width: Full Arch	24 (61.0)	24 (61.0)
Minimum Arch Width: Quarter Arch	15 (38.1)	15 (38.1)
Minimum Arch Height: Full Arch	12 (30.5)	12 (30.5)
Minimum Arch Height: Quarter Arch	12 (30.5)	12 (30.5)
Maximum Arch Width	96 (243.9)	96 (243.9)
Maximum Height of Extended Arches, Quarter Arches	120 (304.8)	120 (304.8)

Mounting Options

- We recommend hold down brackets for quarter arches less than 24" (61.0 cm) in width to ensure level installation
- Arches will receive predrilled openings and fasteners
 - Inside mounts: predrilled openings are located on the underside of the headrail
 - Outside mounts: predrilled openings are located on the front and back face of the headrail

Depth Requirements	2" (5.1 cm) inches (cm)	2 3/8" (6.1 cm) inches (cm)
Minimum	2 1/4 (5.8)	2 3/8 (6.1)
Flush with Casing	3 3/8 (9.9)	3 3/8 (9.9)

NOTE: Due to the nature of the elite process, specialty shapes require an extended lead time. Lead times vary depending on blind sizes and quantities.

Valance



5" (12.7 cm) Flat Valance

- Valance returns are not available

Arched Blinds: Measuring Guidelines

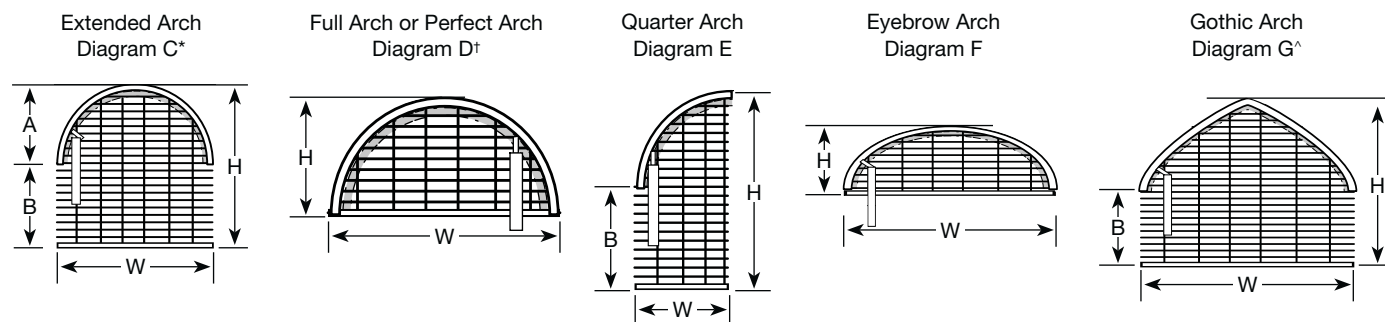

Refer to diagrams for illustrations of measurements to include when ordering an arched blind.

W: Straight width

B*: Length to springline (point where arch begins)

Template needs to extend 6" (15.3 cm) past the springline.

H*: Overall height

A: Arch height

Also specify/include:

- Inside or outside mount
- Control location

*A + B = H

†Perfect arch: height = 1/2 of width;

Perfect 1/4" (0.7 cm) = width and height are the same

^Customer must provide template

Options

Wood Specialty Shapes: Ovals and Circles

Features

- For pricing, see price charts
- Available in 2" (5.1 cm) and 2½" (6.1 cm) slats
- Extruded aluminum headrail
 - 2¼" (5.8 cm) depth x 2" (5.1 cm) height

Controls

- Cord and wand tilt options available
- Standard wood wand lengths are 12" (30.5 cm), 20" (50.8 cm), 30" (76.2 cm), 40" (101.6 cm), and 48" (122.0 cm)
- Polycarbonate wands available in lengths over 48" (122.0 cm)
- Universal joint attachments for wand control
- Wand and cord tilt controls will be approximately one third the length of the blind
- Blinds have tilt function only

Mounting Options

- All shapes receive predrilled openings and fasteners for direct mounting
 - Inside mounts: predrilled openings are located on the underside of the headrail
 - Outside mounts: predrilled openings are located on the front and back face of the headrail

NOTES:

1. For blinds less than 16 square feet (1.49 square meters), valance may appear disproportionate in scale.
2. Due to the nature of the elite process, specialty shapes require an extended lead time. Lead times vary depending on blind sizes and quantities.

Circles and Ovals: Measuring Guidelines

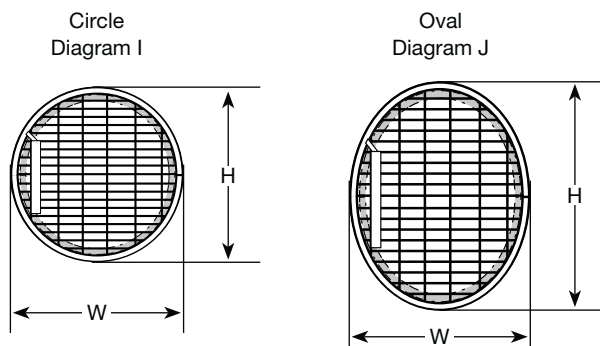

Refer to diagrams for illustrations of measurements to include when ordering a circle or oval blind.

W and H: Provide width and height.

Template required if width and height are not the same.

- Lightblocking headrail is not available
- See below for measuring guidelines
- Not available with cloth tapes, cordless lift, cut-outs, motorized tilt, NoHoles™, or unique finishes

Size Considerations	2" (5.1 cm) inches (cm)	2½" (6.1 cm) inches (cm)
Minimum Diameter Width or Height	24 (61.0)	24 (61.0)
Maximum Diameter Width or Height	72 (182.9)	72 (182.9)

Depth Requirements	2" (5.1 cm) inches (cm)	2½" (6.1 cm) inches (cm)
Minimum	2¼ (5.8)	2½ (6.1)
Flush with Casing	3⅞ (9.9)	3⅞ (9.9)

Valance



5" (12.7 cm) Flat Valance

- Valance returns are not available

NOTES:

1. Maximum spacing between ladders is 24" (61.0 cm).
2. Standard control positions: lift right/tilt left.
3. Maximum slat width is 96" (243.9 cm). Wider blinds must be multiple blinds on one headrail.
4. 7" (17.8 cm) to 8¹⁵/₁₆" (22.8 cm) not available with cloth tapes.
5. Cloth tape ladder quantity is the same as number of ladders listed above.

Also specify/include:

- Inside or outside mount
- Control location

Options

Making a Template for Specialty Blinds

1. Tape butcher paper, kraft, or construction paper over the window opening allowing plenty of overlap.
2. Being careful not to press against the template paper while tracing, draw an exact outline of the window opening. Pressing on the template paper may distort the paper and cause the wrong size to be made.
3. Remove the paper from the window opening. If the shade is an outside mount, add the desired amount of overlap to the window outline and draw a second outline around it to match the shape of the finished shade. Be sure to erase the inside line.
4. Mark the dimensions on the template. Check that the template dimensions match your measurements of the actual window opening.
NOTE: Make sure the template is of the window opening, not the glass only measurement.
5. Cut the shape from the paper.
6. **PLACE THE TEMPLATE BACK INTO THE WINDOW OPENING TO CHECK FOR PROPER FIT COMPLETELY AROUND.**
7. Indicate on the template
 - “Room side” and “top” on the template
 - Purchase order number
 - Customer’s name
 - Your store name and account number
8. Roll up template and place in a mailing tube. **DO NOT FOLD TEMPLATE.**
NOTE: Template of arch top plus 6" (15.3 cm) beyond springline (point where arch begins). Required for elongated arch.

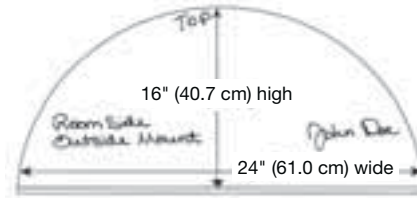

NOTE: This is just a sample for illustration purposes only—other information may be needed for your order.

Mail to: Springs Window Fashions, LLC
33 West Third Street
Suite 400
Williamsport, PA 17701
ATTN: Specialty Dept.

NOTE: When mailing, make sure to get a tracking number and note your return address on the mailing tube.

ACCEPTABLE MATERIALS FOR MAKING TEMPLATES:

- Kraft paper
- Butcher paper
- Construction paper

WE WILL NOT ACCEPT TEMPLATES MADE FROM THE FOLLOWING MATERIALS:

- Newspaper
- Plastic
- Wax paper
- Fabric
- Tissue paper
- Roofing paper
- Existing arch shades
- Wrapping paper
- Cardboard
- Poster board

NOTE: If the material used to make a template stretches, tears easily, will not lay flat, or will mark the fabric—IT WILL NOT BE USED.

Using the Graber® Template Service

To use the template service:

1. Select template service when entering your order online.
2. Use the template worksheet (located on graberdirect.com) to determine what measurements you need to supply for each shape.
3. Enter the lettered measurements using line item comments.

For surcharge see options pricing.

How to measure for the template service:

- Measure the interior of the specialty application to the nearest 1/8" (0.4 cm) using a metal tape measure
- Document each measurement as outlined in “Wood Specialty Shapes: Arched Blinds” section
- Not available with gothic arch

General Information

Slat Count Table: 1" (2.6 cm) Wood Blinds

Number of Slats	1" (2.6 cm) Wood Blinds		Number of Slats	1" (2.6 cm) Wood Blinds	
	Finished Blind Height inches (cm)	Finished Stack Height inches (cm)		Finished Blind Height inches (cm)	Finished Stack Height inches (cm)
11	12 (30.5)	3 ³ / ₄ (9.6)	76	66 ⁷ / ₁₆ (168.5)	
12	12 (30.5)	4 ¹ / ₁₆ (10.3)	77	67 ⁷ / ₁₆ (170.7)	
13	12 ¹ / ₁₆ (32.9)		78	68 (172.8)	
14	13 ¹ / ₁₆ (35.1)		79	68 ³ / ₈ (175.0)	
15	14 ¹ / ₈ (37.2)		80	69 ¹ / ₁₆ (177.1)	13 ¹ / ₄ (35.5)
16	15 ¹ / ₂ (39.4)		81	70 ¹ / ₁₆ (179.3)	
17	16 ³ / ₈ (41.6)		82	71 ³ / ₈ (181.3)	
18	17 ¹ / ₁₆ (43.7)		83	72 ¹ / ₄ (183.6)	
19	18 ¹ / ₁₆ (45.9)		84	73 ³ / ₈ (185.8)	
20	18 ⁷ / ₁₆ (48.0)	5 ¹ / ₄ (13.4)	85	73 ¹ / ₁₆ (187.9)	
21	19 ³ / ₄ (50.2)		86	74 ¹ / ₁₆ (190.1)	
22	20 ¹ / ₁₆ (52.3)		87	75 ³ / ₈ (192.1)	
23	21 ¹ / ₁₆ (54.5)		88	76 ¹ / ₂ (194.4)	
24	22 ¹ / ₄ (56.6)		89	77 ¹ / ₁₆ (196.4)	
25	23 ³ / ₈ (58.8)		90	78 ¹ / ₁₆ (198.6)	15 ³ / ₈ (39.1)
26	24 (61.0)		91	79 (200.7)	
27	24 ³ / ₁₆ (63.1)		92	79 ³ / ₈ (202.9)	
28	25 ¹ / ₁₆ (65.3)		93	80 ³ / ₄ (205.2)	
29	26 ¹ / ₂ (67.4)		94	81 ¹ / ₁₆ (207.2)	
30	27 ³ / ₈ (69.6)	6 ¹ / ₁₆ (17.0)	95	82 ¹ / ₁₆ (209.4)	
31	28 ³ / ₁₆ (71.6)		96	83 ¹ / ₄ (211.5)	
32	29 ¹ / ₁₆ (73.9)		97	84 ¹ / ₈ (213.7)	
33	29 ³ / ₈ (75.9)		98	84 ¹ / ₁₆ (215.8)	
34	30 ³ / ₄ (78.2)		99	85 ¹ / ₁₆ (218.0)	
35	31 ³ / ₈ (80.4)		100	86 ³ / ₈ (220.1)	16 ³ / ₈ (42.9)
36	32 ¹ / ₁₆ (82.4)		101	87 ¹ / ₂ (222.3)	
37	33 ³ / ₁₆ (84.7)		102	88 ³ / ₈ (224.5)	
38	34 ³ / ₈ (86.7)		103	89 ¹ / ₁₆ (226.6)	
39	35 (88.9)		104	90 ¹ / ₁₆ (228.8)	
40	35 ¹ / ₁₆ (91.0)	8 ³ / ₈ (20.7)	105	90 ³ / ₈ (230.9)	
41	36 ¹ / ₁₆ (93.2)		106	91 ³ / ₄ (233.1)	
42	37 ¹ / ₂ (95.3)		107	92 ¹ / ₁₆ (235.2)	
43	38 ³ / ₈ (97.5)		108	93 ¹ / ₁₆ (237.4)	
44	39 ¹ / ₁₆ (99.6)		109	94 ¹ / ₄ (239.4)	
45	40 ¹ / ₁₆ (101.8)		110	95 ³ / ₈ (241.7)	18 ¹ / ₄ (46.4)
46	40 ¹ / ₁₆ (104.0)		111	95 ¹ / ₁₆ (243.7)	
47	41 ³ / ₄ (106.1)		112	96 ¹ / ₁₆ (246.0)	
48	42 ³ / ₈ (108.3)		113	97 ¹ / ₁₆ (248.2)	
49	43 ¹ / ₁₆ (110.4)		114	98 ¹ / ₂ (250.2)	
50	44 ¹ / ₁₆ (112.6)	9 ³ / ₁₆ (24.3)	115	99 ³ / ₈ (252.5)	
51	45 ³ / ₈ (114.7)		116	100 ³ / ₁₆ (254.5)	
52	46 (116.9)		117	101 ¹ / ₁₆ (256.7)	
53	46 ¹ / ₁₆ (119.0)		118	101 ³ / ₈ (258.8)	
54	47 ¹ / ₁₆ (121.2)		119	102 ³ / ₄ (261.0)	
55	48 ³ / ₁₆ (123.4)		120	103 ³ / ₁₆ (263.1)	19 ³ / ₄ (50.2)
56	49 ³ / ₈ (125.5)		121	104 ¹ / ₁₆ (265.3)	
57	50 ¹ / ₄ (127.7)		122	105 ³ / ₁₆ (267.5)	
58	51 ¹ / ₁₆ (129.7)		123	106 ¹ / ₈ (269.6)	
59	51 ¹ / ₁₆ (132.0)		124	107 (271.8)	
60	52 ¹ / ₄ (134.0)	11 (28.0)	125	107 ¹ / ₁₆ (273.9)	
61	53 ³ / ₈ (136.3)		126	108 ¹ / ₁₆ (276.1)	
62	54 ¹ / ₁₆ (138.3)		127	109 ¹ / ₂ (278.2)	
63	55 ³ / ₁₆ (140.5)		128	110 ³ / ₈ (280.4)	
64	56 ³ / ₁₆ (142.8)		129	111 ¹ / ₄ (282.6)	
65	57 (144.8)		130	112 ¹ / ₁₆ (284.7)	21 ³ / ₁₆ (53.9)
66	57 ³ / ₈ (147.1)		131	112 ¹ / ₁₆ (286.9)	
67	58 ¹ / ₁₆ (149.1)		132	113 ³ / ₄ (289.0)	
68	59 ¹ / ₁₆ (151.3)		133	114 ³ / ₈ (291.2)	
69	60 ³ / ₈ (153.4)		134	115 ¹ / ₁₆ (293.3)	
70	61 ¹ / ₄ (155.6)	12 ¹ / ₂ (31.8)	135	116 ³ / ₁₆ (295.5)	
71	62 ¹ / ₁₆ (157.7)		136	117 ³ / ₈ (297.5)	
72	62 ¹ / ₁₆ (159.9)		137	118 (299.8)	
73	63 ¹ / ₁₆ (162.1)		138	118 ³ / ₁₆ (301.8)	
74	64 ³ / ₈ (164.2)		139	119 ¹ / ₁₆ (304.1)	
75	65 ¹ / ₂ (166.4)		140	120 ¹ / ₂ (306.1)	22 ³ / ₈ (57.5)

NOTE: Finished height includes headrail and bottomrail.

General Information

Slat Count Table: 2" (5.1 cm) Wood Blinds

Number of Slats	2" (5.1 cm) Wood and Elite Wood Blinds and NoHoles™		2" (5.1 cm) Wood and Elite Wood Blinds with Cordless Lift		Number of Slats	2" (5.1 cm) Wood and Elite Wood Blinds and NoHoles		2" (5.1 cm) Wood and Elite Wood Blinds with Cordless Lift	
	Finished Blind Height inches (cm)	Finished Stack Height inches (cm)	Finished Blind Height inches (cm)	Finished Stack Height inches (cm)		Finished Blind Height inches (cm)	Finished Stack Height inches (cm)	Finished Blind Height inches (cm)	Finished Stack Height inches (cm)
7	12 (30.5)	4 ³ / ₈ (11.1)	12 (30.5)	4 ⁷ / ₈ (12.4)	39	67 ⁷ / ₈ (171.7)		68 ¹ / ₈ (172.9)	
8	13 ¹ / ₈ (35.1)		14 ⁵ / ₈ (36.4)		40	69 ¹ / ₈ (175.9)	9 ⁵ / ₈ (24.5)	69 ³ / ₈ (177.2)	10 ¹ / ₈ (25.8)
9	15 ⁵ / ₈ (39.6)		16 ¹ / ₈ (40.8)		41	71 (180.4)		71 ¹ / ₂ (181.7)	
10	17 ⁷ / ₈ (44.0)	4 ⁷ / ₈ (12.4)	17 ¹ / ₈ (45.3)	5 ³ / ₈ (13.7)	42	72 ³ / ₈ (184.8)		73 ³ / ₈ (186.1)	
11	19 ¹ / ₈ (48.5)		19 ⁵ / ₈ (49.7)		43	74 ⁷ / ₈ (189.1)		74 ¹ / ₈ (190.4)	
12	20 ³ / ₈ (52.8)		21 ¹ / ₈ (54.0)		44	76 ³ / ₈ (193.6)		76 ¹ / ₈ (194.8)	
13	22 ¹ / ₂ (57.2)		23 (58.5)		45	77 ¹ / ₈ (198.0)		78 ¹ / ₈ (199.3)	
14	24 ¹ / ₈ (61.6)		24 ³ / ₈ (62.9)		46	79 ¹ / ₈ (202.5)		80 ³ / ₈ (203.7)	
15	25 ⁵ / ₈ (65.9)		26 ⁷ / ₈ (67.2)		47	81 ³ / ₈ (206.7)		81 ¹ / ₂ (208.0)	
16	27 ¹ / ₈ (70.4)		28 ³ / ₈ (71.6)		48	83 ¹ / ₈ (211.2)		83 ⁵ / ₈ (212.5)	11 ⁷ / ₈ (29.1)
17	29 ³ / ₈ (74.8)		29 ⁵ / ₈ (76.1)		49	84 ⁷ / ₈ (215.6)		85 ³ / ₈ (216.9)	
18	31 ³ / ₈ (79.3)		31 ¹ / ₈ (80.5)		50	86 ³ / ₈ (219.9)	11 ¹ / ₄ (28.6)	86 (218.5)	
19	32 ⁷ / ₈ (83.6)		33 ³ / ₈ (84.8)		51	88 ³ / ₈ (224.4)			
20	34 ⁵ / ₈ (88.0)	6 ¹ / ₂ (16.6)	35 ⁵ / ₈ (89.3)	7 (17.8)	52	90 ¹ / ₈ (228.8)			
21	36 ³ / ₈ (92.4)		36 ⁷ / ₈ (93.7)		53	91 ¹ / ₈ (233.3)			
22	38 ³ / ₈ (96.7)		38 ³ / ₈ (98.0)		54	93 ¹ / ₂ (237.5)			
23	39 ³ / ₈ (101.2)		40 ⁵ / ₈ (102.4)		55	95 ¹ / ₈ (242.0)			
24	41 ³ / ₈ (105.6)		42 ¹ / ₈ (106.9)		56	97 (246.4)			
25	43 ³ / ₈ (110.1)		43 ¹ / ₈ (111.3)		57	98 ¹ / ₈ (250.7)			
26	45 (114.3)		45 ¹ / ₂ (115.6)		58	100 ¹ / ₈ (255.2)			
27	46 ³ / ₈ (118.8)		47 ¹ / ₈ (120.1)		59	102 ³ / ₈ (259.6)			
28	48 ¹ / ₂ (123.2)		49 (124.5)		60	103 ³ / ₈ (263.9)	12 ³ / ₈ (32.6)		
29	50 ³ / ₈ (127.5)		50 ¹ / ₈ (128.8)		61	105 ³ / ₈ (268.3)			
30	51 ⁵ / ₈ (132.0)	8 ¹ / ₈ (20.5)	52 ⁷ / ₈ (133.2)	8 ³ / ₈ (21.8)	62	107 ³ / ₈ (272.8)			
31	53 ¹ / ₈ (136.4)		54 ³ / ₈ (137.7)		63	109 ¹ / ₈ (277.2)			
32	55 ⁷ / ₈ (140.9)		55 ¹ / ₈ (142.1)		64	110 ³ / ₈ (281.5)			
33	57 ¹ / ₈ (145.1)		57 ³ / ₈ (146.4)		65	112 ³ / ₈ (286.0)			
34	58 ³ / ₈ (149.6)		59 ³ / ₈ (150.9)		66	114 ³ / ₈ (290.4)			
35	60 ³ / ₈ (154.0)		61 ¹ / ₈ (155.3)		67	116 (294.7)			
36	62 ³ / ₈ (158.3)		62 ¹ / ₈ (159.6)		68	117 ³ / ₈ (299.1)			
37	64 ¹ / ₈ (162.8)		64 ³ / ₈ (164.0)		69	119 ¹ / ₂ (303.6)	14 ¹ / ₄ (36.2)		
38	65 ³ / ₈ (167.2)		66 ³ / ₈ (168.5)		70	120 (304.8)			

NOTE: Finished height includes headrail and bottomrail. Excludes specialty shapes.

General Information

Slat Count Table: 2³/₈" (6.1 cm) Wood Blinds

Number of Slats	2 ³ / ₈ " (6.1 cm) Wood and Elite Wood Blinds and NoHoles™		2 ³ / ₈ " (6.1 cm) Wood and Elite Wood Blinds with Cordless Lift		Number of Slats	2 ³ / ₈ " (6.1 cm) Wood and Elite Wood Blinds and NoHoles		2 ³ / ₈ " (6.1 cm) Wood and Elite Wood Blinds with Cordless Lift	
	Finished Blind Height inches (cm)	Finished Stack Height inches (cm)	Finished Blind Height inches (cm)	Finished Stack Height inches (cm)		Finished Blind Height inches (cm)	Finished Stack Height inches (cm)	Finished Blind Height inches (cm)	Finished Stack Height inches (cm)
6			12 (30.5)	4 ¹⁵ / ₁₆ (12.5)	32	67 ¹ / ₂ (170.5)		67 ³ / ₄ (172.1)	
7	12 (30.5)	4 ³ / ₈ (11.1)	14 ⁵ / ₈ (37.2)		33	69 ¹ / ₄ (175.9)		69 ⁵ / ₈ (177.5)	
8	16 ¹ / ₁₆ (40.8)		16 ³ / ₄ (42.6)		34	71 ³ / ₈ (181.3)		72 (182.9)	
9	18 ³ / ₁₆ (46.2)		18 ⁷ / ₈ (48.0)		35	73 ¹ / ₂ (186.7)		74 ¹ / ₄ (188.3)	
10	20 ⁵ / ₁₆ (51.6)	4 ⁷ / ₈ (12.4)	21 (53.4)	5 ⁵ / ₁₆ (14.2)	36	75 ⁵ / ₈ (192.1)		76 ¹ / ₄ (193.7)	
11	22 ⁷ / ₁₆ (57.0)		23 ¹ / ₈ (58.8)		37	77 ³ / ₈ (197.5)		78 ³ / ₈ (199.1)	
12	24 ⁹ / ₁₆ (62.4)		25 ¹ / ₄ (64.2)		38	79 ¹ / ₂ (202.9)		80 ¹ / ₂ (204.5)	
13	26 ¹¹ / ₁₆ (67.8)		27 ⁵ / ₈ (69.6)		39	82 (208.3)		82 ³ / ₈ (209.9)	
14	28 ¹³ / ₁₆ (73.2)		29 ¹ / ₂ (75.0)		40	84 ¹ / ₄ (213.7)	9 ⁵ / ₈ (24.5)	84 ³ / ₄ (215.3)	10 ⁵ / ₁₆ (26.2)
15	30 ¹⁵ / ₁₆ (78.6)		31 ³ / ₈ (80.4)		41	86 ¹ / ₄ (219.1)		86 (218.5)	
16	33 ¹ / ₈ (84.2)		33 ³ / ₄ (85.8)		42	88 ³ / ₈ (224.5)			
17	35 ¹ / ₄ (89.6)		35 ⁵ / ₈ (91.2)		43	90 ¹ / ₂ (229.9)			
18	37 ³ / ₈ (95.0)		38 (96.6)		44	92 ³ / ₈ (235.3)			
19	39 ¹ / ₂ (100.4)		40 ¹ / ₈ (102.0)		45	94 ³ / ₄ (240.7)			
20	41 ⁵ / ₈ (105.8)	6 ¹ / ₂ (16.6)	42 ¹ / ₄ (107.4)	7 ¹ / ₈ (18.1)	46	96 ⁵ / ₈ (246.1)			
21	43 ³ / ₄ (111.2)		44 ³ / ₈ (112.8)		47	99 (251.5)			
22	45 ⁵ / ₈ (116.6)		46 ¹ / ₂ (118.2)		48	101 ¹ / ₈ (256.9)			
23	48 (122.0)		48 ³ / ₈ (123.6)		49	103 ¹ / ₄ (262.3)			
24	50 ¹ / ₈ (127.4)		50 ³ / ₄ (129.0)		50	105 ⁵ / ₈ (267.7)	11 ¹ / ₄ (28.6)		
25	52 ¹ / ₄ (132.8)		52 ¹ / ₂ (134.4)		51	107 ¹ / ₂ (273.1)			
26	54 ³ / ₈ (138.2)		55 (139.7)		52	109 ⁵ / ₈ (278.5)			
27	56 ¹ / ₂ (143.6)		57 ¹ / ₈ (145.1)		53	111 ¹ / ₄ (283.9)			
28	58 ³ / ₈ (149.0)		59 ¹ / ₄ (150.5)		54	113 ³ / ₈ (289.3)			
29	60 ¹ / ₄ (154.4)		61 ³ / ₈ (155.9)		55	116 (294.7)			
30	62 ¹ / ₂ (159.8)	8 ¹ / ₁₆ (20.5)	63 ¹ / ₂ (161.3)	8 ³ / ₄ (22.3)	56	118 ¹ / ₂ (300.1)	12 ³ / ₁₆ (31.0)		
31	65 (165.1)		65 ⁵ / ₈ (166.7)		57	120 (304.8)			

NOTE: Finished height includes headrail and bottomrail. Excludes specialty shapes.

General Information

Slat Count Table: 2" (5.1 cm) Composite, Premium Faux Wood, and Faux Wood Blinds

Number of Slats	2" (5.1 cm) Composite Blinds and NoHoles™		2" (5.1 cm) Premium Faux Wood and Faux Wood Blinds and NoHoles		2" (5.1 cm) Composite, Premium Faux Wood, and Faux Wood Blinds with Cordless Lift		Number of Slats	2" (5.1 cm) Composite Blinds and NoHoles		2" (5.1 cm) Premium Faux Wood and Faux Wood Blinds and NoHoles		2" (5.1 cm) Composite, Premium Faux Wood, and Faux Wood Blinds with Cordless Lift	
	Finished Blind Height inches (cm)	Finished Stack Height inches (cm)	Finished Blind Height inches (cm)	Finished Stack Height inches (cm)	Finished Blind Height inches (cm)	Finished Stack Height inches (cm)		Finished Blind Height inches (cm)	Finished Stack Height inches (cm)	Finished Blind Height inches (cm)	Finished Stack Height inches (cm)	Finished Blind Height inches (cm)	Finished Stack Height inches (cm)
5	12 (30.5)	4¼ (10.8)	12 (30.5)	4¼ (10.8)	12 (30.5)	4¾ (11.6)	37	67¾ (171.7)		67¾ (171.7)		66¾ (168.5)	
6	13⅜ (35.1)		13⅜ (35.1)		12¾ (32.1)		38	69¼ (175.9)		69¼ (175.9)		68¾ (172.9)	
7	15⅞ (39.6)		15⅞ (39.6)		14⅞ (36.4)		39	71 (180.4)		71 (180.4)		69¾ (177.2)	
8	17⅞ (44.0)		17⅞ (44.0)		16⅞ (40.8)		40	72¼ (184.8)	9⅞ (25.0)	72¼ (184.8)	9⅞ (25.0)	71½ (181.7)	10⅞ (25.8)
9	19⅞ (48.5)		19⅞ (48.5)		17⅞ (45.3)		41	74⅞ (189.1)		74⅞ (189.1)		72 (182.9)	
10	20¾ (52.8)	5⅞ (12.9)	20¾ (52.8)	5⅞ (12.9)	19⅞ (49.7)	5¾ (13.7)	42	76⅞ (193.6)		76⅞ (193.6)			
11	22½ (57.2)		22½ (57.2)		21¼ (54.0)		43	77⅞ (198.0)		77⅞ (198.0)			
12	24¼ (61.6)		24¼ (61.6)		23 (58.5)		44	79⅞ (202.5)		79⅞ (202.5)			
13	25⅞ (65.9)		25⅞ (65.9)		24¾ (62.9)		45	81¾ (206.7)		81¾ (206.7)			
14	27⅞ (70.4)		27⅞ (70.4)		26⅞ (67.2)		46	83¾ (211.2)		83¾ (211.2)			
15	29⅞ (74.8)		29⅞ (74.8)		28⅞ (71.6)		47	84⅞ (215.6)		84⅞ (215.6)			
16	31⅞ (79.3)		31⅞ (79.3)		29⅞ (76.1)		48	86⅞ (219.9)		86⅞ (219.9)			
17	32⅞ (83.6)		32⅞ (83.6)		31⅞ (80.5)		49	88⅞ (224.4)		88⅞ (224.4)			
18	34⅞ (88.0)		34⅞ (88.0)		33¾ (84.8)		50	90⅞ (228.8)	11¾ (28.9)	90⅞ (228.8)	11¾ (28.9)		
19	36⅞ (92.4)		36⅞ (92.4)		35¾ (89.3)		51	91⅞ (233.3)		91⅞ (233.3)			
20	38⅞ (96.7)	6⅞ (16.9)	38⅞ (96.7)	6⅞ (16.9)	36¾ (93.7)	7 (17.8)	52	93⅞ (237.5)		93⅞ (237.5)			
21	39⅞ (101.2)		39⅞ (101.2)		38⅞ (98.0)		53	95⅞ (242.0)		95⅞ (242.0)			
22	41⅞ (105.6)		41⅞ (105.6)		40⅞ (102.4)		54	97 (246.4)		97 (246.4)			
23	43⅞ (110.1)		43⅞ (110.1)		42⅞ (106.9)		55	98⅞ (250.7)		98⅞ (250.7)			
24	45 (114.3)		45 (114.3)		43⅞ (111.3)		56	100⅞ (255.2)		100⅞ (255.2)			
25	46¾ (118.8)		46¾ (118.8)		45½ (115.6)		57	102⅞ (259.6)		102⅞ (259.6)			
26	48½ (123.2)		48½ (123.2)		47¼ (120.1)		58	103⅞ (263.9)		103⅞ (263.9)			
27	50⅞ (127.5)		50⅞ (127.5)		49 (124.5)		59	105⅞ (268.3)		105⅞ (268.3)			
28	51⅞ (132.0)		51⅞ (132.0)		50⅞ (128.8)		60	107⅞ (272.8)	13 (33.1)	107⅞ (272.8)	13 (33.1)		
29	53⅞ (136.4)		53⅞ (136.4)		52⅞ (133.2)		61	109⅞ (277.2)		109⅞ (277.2)			
30	55⅞ (140.9)	8¼ (21.0)	55⅞ (140.9)	8¼ (21.0)	54⅞ (137.7)	8⅞ (21.8)	62	110⅞ (281.5)		110⅞ (281.5)			
31	57⅞ (145.1)		57⅞ (145.1)		55⅞ (142.1)		63	112⅞ (286.0)		112⅞ (286.0)			
32	58⅞ (149.6)		58⅞ (149.6)		57⅞ (146.4)		64	114⅞ (290.4)		114⅞ (290.4)			
33	60⅞ (154.0)		60⅞ (154.0)		59⅞ (150.9)		65	116 (294.7)		116 (294.7)			
34	62⅞ (158.3)		62⅞ (158.3)		61⅞ (155.3)		66	117¼ (299.1)		117¼ (299.1)			
35	64⅞ (162.8)		64⅞ (162.8)		62⅞ (159.6)		67	119⅞ (303.6)		119⅞ (303.6)			
36	65⅞ (167.2)		65⅞ (167.2)		64⅞ (164.0)		68	121¼ (308.0)	14¼ (36.2)	121¼ (308.0)	14¼ (36.2)		

NOTE: Finished height includes headrail and bottomrail.

General Information

Slat Count Table: 2½" (6.4 cm) Composite, Premium Faux Wood, and Faux Wood Blinds

Number of Slats	2½" (6.4 cm) Composite Blinds and NoHoles™		2½" (5.1 cm) Premium Faux Wood and Faux Wood Blinds and NoHoles		2½" (5.1 cm) Composite, Premium Faux Wood, and Faux Wood Blinds with Cordless Lift	
	Finished Blind Height inches (cm)	Finished Stack Height inches (cm)	Finished Blind Height inches (cm)	Finished Stack Height inches (cm)	Finished Blind Height inches (cm)	Finished Stack Height inches (cm)
	5	12 (30.5)	4¼ (10.8)	12 (30.5)	4¼ (10.8)	12 (30.5)
6	16⅜ (41.2)		16⅜ (41.2)		14⅜ (37.2)	
7	18⅝ (46.6)		18⅝ (46.6)		16¾ (42.6)	
8	20⅞ (52.0)		20⅞ (52.0)		18⅞ (48.0)	
9	22⅞ (57.4)		22⅞ (57.4)		21 (53.4)	
10	24⅞ (62.8)	5⅛ (12.9)	24⅞ (62.8)	5⅛ (12.9)	23⅞ (58.8)	5⅞ (14.2)
11	26⅞ (68.2)		26⅞ (68.2)		25¾ (64.2)	
12	28⅞ (73.6)		28⅞ (73.6)		27⅞ (69.6)	
13	31⅞ (78.9)		31⅞ (78.9)		29½ (75.0)	
14	33⅞ (84.3)		33⅞ (84.3)		31⅞ (80.4)	
15	35⅞ (89.7)		35⅞ (89.7)		33¾ (85.8)	
16	37⅞ (95.1)		37⅞ (95.1)		35⅞ (91.2)	
17	39⅞ (100.5)		39⅞ (100.5)		38 (96.6)	
18	41⅞ (105.9)		41⅞ (105.9)		40⅞ (102.0)	
19	43⅞ (111.5)		43⅞ (111.5)		42¼ (107.4)	
20	46 (116.9)	6⅞ (16.9)	46 (116.9)	6⅞ (16.9)	44⅞ (112.8)	7⅞ (18.1)
21	48⅞ (122.3)		48⅞ (122.3)		46½ (118.2)	
22	50¾ (127.7)		50¾ (127.7)		48⅞ (123.6)	
23	52⅞ (133.1)		52⅞ (133.1)		50¾ (129.0)	
24	54½ (138.5)		54½ (138.5)		52⅞ (134.4)	
25	56⅞ (143.9)		56⅞ (143.9)		55 (139.7)	
26	58¾ (149.3)		58¾ (149.3)		57⅞ (145.1)	
27	60⅞ (154.7)		60⅞ (154.7)		59¼ (150.5)	
28	63 (160.1)		63 (160.1)		61⅞ (155.9)	
29	65⅞ (165.5)		65⅞ (165.5)		63½ (161.3)	
30	67¼ (170.9)	8¼ (21.0)	67¼ (170.9)	8¼ (21.0)	65⅞ (166.7)	8¾ (22.3)

Number of Slats	2½" (6.4 cm) Composite Blinds and NoHoles		2½" (5.1 cm) Premium Faux Wood and Faux Wood Blinds and NoHoles		2½" (5.1 cm) Composite, Premium Faux Wood, and Faux Wood Blinds with Cordless Lift	
	Finished Blind Height inches (cm)	Finished Stack Height inches (cm)	Finished Blind Height inches (cm)	Finished Stack Height inches (cm)	Finished Blind Height inches (cm)	Finished Stack Height inches (cm)
	31	69⅞ (176.3)		69⅞ (176.3)		67¼ (172.1)
32	71½ (181.7)		71½ (181.7)		69⅞ (177.5)	
33	73⅞ (187.1)		73⅞ (187.1)		72 (182.9)	
34	75¾ (192.5)		75¾ (192.5)			
35	77⅞ (197.9)		77⅞ (197.9)			
36	80 (203.2)		80 (203.2)			
37	82⅞ (208.6)		82⅞ (208.6)			
38	84¾ (214.0)		84¾ (214.0)			
39	86⅞ (219.4)		86⅞ (219.4)			
40	88½ (224.8)	9⅞ (25.0)	88½ (224.8)	9⅞ (25.0)		
41	90⅞ (230.2)		90⅞ (230.2)			
42	92¾ (235.6)		92¾ (235.6)			
43	94⅞ (241.0)		94⅞ (241.0)			
44	97 (246.4)		97 (246.4)			
45	99⅞ (251.8)		99⅞ (251.8)			
46	101¼ (257.2)		101¼ (257.2)			
47	103⅞ (262.6)		103⅞ (262.6)			
48	105½ (268.0)		105½ (268.0)			
49	107⅞ (273.4)		107⅞ (273.4)			
50	109¾ (278.8)	11⅞ (28.9)	109¾ (278.8)	11⅞ (28.9)		
51	111⅞ (284.2)		111⅞ (284.2)			
52	114 (289.6)		114 (289.6)			
53	116⅞ (295.0)		116⅞ (295.0)			
54	118¾ (300.4)		118¾ (300.4)			
55	120⅞ (305.8)	12⅞ (31.0)	120⅞ (305.8)	12⅞ (31.0)		

NOTE: Finished height includes headrail and bottomrail.

General Information

Slat Route and Ladder Count Charts

Take any inside mount deductions before determining ladder quantity (inside mount— $\frac{1}{2}$ " (1.3 cm); outside mount—no deduction).

Blinds with two lift cords will have two clear plastic cord stop beads located approximately 2" (5.1 cm) below the headrail. Cords will continue down, each ending in a tassel. Blinds with three or more lift cords will have the cords joined together with a tassel approximately 2" (5.1 cm) below the headrail. Two individual cords will continue down, each ending in a tassel.

Traditions® 1" (2.6 cm) Wood Blinds

For Standard or Reverse Controls

Finished Blind Width inches (cm)	Slat End Route inches (cm)	# of Ladders	# of Lifts	# of Center Brackets
7 to 8 $\frac{1}{16}$ " (17.8 to 22.8)	1 $\frac{3}{4}$ (4.5)	2	2	0
9 to 13 $\frac{3}{4}$ " (22.9 to 35.0)	3 $\frac{3}{4}$ (8.3)	2	2	0
13 $\frac{1}{16}$ to 20 $\frac{3}{4}$ " (35.1 to 52.8)	4 (10.2)	2	2	0
20 $\frac{1}{16}$ to 35" (52.9 to 88.9)	6 (15.3)	2	2	0
35 $\frac{1}{16}$ to 58" (89.1 to 147.4)	6 (15.3)	3	2	1 over 48" (122.0 cm) FBW
58 $\frac{1}{16}$ to 81" (147.5 to 205.8)	6 (15.3)	4	4	2 over 78" (198.2 cm) FBW
81 $\frac{1}{16}$ to 96" (205.9 to 243.9)	6 (15.3)	5	4	2

For Same Side Controls

13 $\frac{1}{16}$ to 20 $\frac{3}{4}$ " (35.1 to 52.8)	4 $\frac{7}{8}$ (12.4)	As stated above		
20 $\frac{1}{16}$ to 96" (52.9 to 243.9)	6 (15.3)	As stated above		

NOTES:

1. Maximum spacing between ladders is 23" (58.5 cm).
2. Standard control positions: lift right/tilt left.
3. Maximum slat width is 96" (243.9 cm). Wider blinds must be multiple blinds on one headrail.

Traditions 2" (5.1 cm) and 2 $\frac{3}{8}$ " (6.1 cm) Wood Blinds

For Standard or Reverse Controls

Finished Blind Width inches (cm)	Slat End Route inches (cm)	# of Ladders	# of Lifts	NoHoles™ # of Cords	# of Center Brackets
7 to 8 $\frac{1}{16}$ " (17.8 to 22.8)	1 $\frac{3}{8}$ (3.5)	2	2	4	0
9 to 11 $\frac{1}{16}$ " (22.9 to 30.4)	2 $\frac{1}{8}$ (6.1)	2	2	4	0
12 to 24" (30.5 to 61.0)	4 (10.2)	2	2	4	0
24 $\frac{1}{16}$ to 36" (61.2 to 91.5)	6 (15.3)	2	2	4	0
36 $\frac{1}{16}$ to 60" (91.6 to 152.4)	6 (15.3)	3	2	3	1 over 48" (122.0 cm) FBW
60 $\frac{1}{16}$ to 84" (152.6 to 213.4)	6 (15.3)	4	4	4	2 over 72" (182.9 cm) FBW
84 $\frac{1}{16}$ to 96" (213.6 to 243.9)	6 (15.3)	5	4	4	2

For Same Side Controls

16 $\frac{1}{16}$ to 96" (40.8 to 243.9)	6 (15.3)	As stated above			
---	----------	-----------------	--	--	--

NOTES:

1. Maximum spacing between ladders is 24" (61.0 cm).
2. Standard control positions: lift right/tilt left.
3. Maximum slat width is 96" (243.9 cm). Wider blinds must be multiple blinds on one headrail.
4. 7" (17.8 cm) to 8 $\frac{1}{16}$ " (22.8 cm) not available with cloth tapes.
5. Cloth tape ladder quantity is the same as number of ladders listed above.

Traditions 2" (5.1 cm) and 2 $\frac{3}{8}$ " (6.1 cm) Wood Blinds with Cordless Lift

For Standard or Reverse Controls

Finished Blind Width inches (cm)	Slat End Route inches (cm)	# of Ladders	# of Lifts	# of Center Brackets
12 to 24" (30.5 to 61.0)	4 (10.2)	2	2	0
24 $\frac{1}{16}$ to 36 $\frac{1}{2}$ " (61.2 to 92.8)	6 $\frac{1}{2}$ (16.6)	2	2	0
36 $\frac{1}{16}$ to 50" (92.9 to 127.0)	6 $\frac{1}{2}$ (16.6)	3	2	1 over 48" (122.0 cm) FBW
50 $\frac{1}{16}$ to 60" (127.2 to 152.4)	6 $\frac{1}{2}$ (16.6)	3	3	1
60 $\frac{1}{16}$ to 84" (152.6 to 213.4)	6 $\frac{1}{2}$ (16.6)	4	4	2 over 72" (182.9 cm) FBW

NOTES:

1. Maximum spacing between ladders is 23 $\frac{1}{2}$ " (59.7 cm).
2. Standard control positions: tilt left; tilt right is optional.
3. Maximum slat width is 84" (213.4 cm). Wider blinds must be multiple blinds on one headrail.
4. Cloth tape ladder quantity is the same as number of ladders listed above.

General Information

Slat Route and Ladder Count Charts

Take any inside mount deductions before determining ladder quantity (inside mount— $\frac{1}{2}$ " (1.3 cm); outside mount—no deduction). Excludes specialty shapes.

Blinds with two lift cords will have two clear plastic cord stop beads located approximately 2" (5.1 cm) below the headrail. Cords will continue down, each ending in a tassel. Blinds with three or more lift cords will have the cords joined together with a tassel approximately 2" (5.1 cm) below the headrail. Two individual cords will continue down, each ending in a tassel.

2" (5.1 cm) and 2 $\frac{3}{8}$ " (6.1 cm) Elite Wood Blinds

For Standard or Reverse Controls

Finished Blind Width inches (cm)	Slat End Route inches (cm)	# of Ladders	# of Lifts	NoHoles™ # of Cords	# of Center Brackets
7 to 8 $\frac{1}{16}$ (17.8 to 22.8)	1 $\frac{3}{8}$ (3.5)	2	2	4	0
9 to 11 $\frac{1}{16}$ (22.9 to 30.4)	2 $\frac{3}{8}$ (6.1)	2	2	4	0
12 to 24 (30.5 to 61.0)	4 (10.2)	2	2	4	0
24 $\frac{1}{16}$ to 36 (61.2 to 91.5)	6 (15.3)	2	2	4	0
36 $\frac{1}{16}$ to 60 (91.6 to 152.4)	6 (15.3)	3	2	3	1 over 48" (122.0 cm) FBW
60 $\frac{1}{16}$ to 84 (152.6 to 213.4)	6 (15.3)	4	4	4	2 over 72" (182.9 cm) FBW
84 $\frac{1}{16}$ to 96 (213.6 to 243.9)	6 (15.3)	5	4	4	2

For Same Side Controls

16 $\frac{1}{16}$ to 96 (40.8 to 243.9)	6 (15.3)	As stated above			
---	----------	-----------------	--	--	--

NOTES:

- Maximum spacing between ladders is 24" (61.0 cm).
- Standard control positions: lift right/tilt left.
- Maximum slat width is 96" (243.9 cm). Wider blinds must be multiple blinds on one headrail.
- 7" (17.8 cm) to 8 $\frac{1}{16}$ " (22.8 cm) not available with cloth tapes.
- Cloth tape ladder quantity is the same as number of ladders listed above.

2" (5.1 cm) and 2 $\frac{3}{8}$ " (6.1 cm) Elite Wood Blinds with Cordless Lift

For Standard or Reverse Controls

Finished Blind Width inches (cm)	Slat End Route inches (cm)	# of Ladders	# of Lifts	# of Center Brackets
12 to 24 (30.5 to 61.0)	4 (10.2)	2	2	0
24 $\frac{1}{16}$ to 36 $\frac{1}{2}$ (61.2 to 92.8)	6 $\frac{1}{2}$ (16.6)	2	2	0
36 $\frac{9}{16}$ to 50 (92.9 to 127.0)	6 $\frac{1}{2}$ (16.6)	3	2	1 over 48" (122.0 cm) FBW
50 $\frac{1}{16}$ to 60 (127.2 to 152.4)	6 $\frac{1}{2}$ (16.6)	3	3	1
60 $\frac{1}{16}$ to 84 (152.6 to 213.4)	6 $\frac{1}{2}$ (16.6)	4	4	2 over 72" (182.9 cm) FBW

NOTES:

- Maximum spacing between ladders is 23 $\frac{1}{2}$ " (59.7 cm).
- Standard control positions: tilt left; tilt right is optional.
- Maximum slat width is 84" (213.4 cm). Wider blinds must be multiple blinds on one headrail.
- Cloth tape ladder quantity is the same as number of ladders listed above.

General Information

Slat Route and Ladder Count Charts

Take any inside mount deductions before determining ladder quantity (inside mount— $\frac{1}{2}$ " (1.3 cm); outside mount—no deduction).

Blinds with two lift cords will have two clear plastic cord stop beads located approximately 2" (5.1 cm) below the headrail. Cords will continue down, each ending in a tassel. Blinds with three or more lift cords will have the cords joined together with a tassel approximately 2" (5.1 cm) below the headrail. Two individual cords will continue down, each ending in a tassel.

Traditions® 2" (5.1 cm) and 2½" (6.4 cm) Composite Blinds

For Standard or Reverse Controls

Finished Blind Width inches (cm)	Slat End Route inches (cm)	# of Ladders	# of Lifts	NoHoles™ # of Cords	# of Center Brackets
7 to 8 ¹⁵ / ₁₆ (17.8 to 22.8)	1¾ (3.5)	2	2	4	0
9 to 11 ¹⁵ / ₁₆ (22.9 to 30.4)	2¾ (6.1)	2	2	4	0
12 to 22 (30.5 to 55.9)	4 (10.2)	2	2	4	0
22 ¹ / ₁₆ to 38 (56.1 to 96.6)	5 (12.7)	3	2	3	0
38 ¹ / ₁₆ to 52 (96.7 to 132.1)	5 (12.7)	4	4	4	1 over 48" (122.0 cm) FBW
52 ¹ / ₁₆ to 66 (132.3 to 167.7)	5 (12.7)	5	3	4	1
66 ¹ / ₁₆ to 80 (167.8 to 203.2)	5 (12.7)	6	4	4	2 over 72" (182.9 cm) FBW
80 ¹ / ₁₆ to 94 (203.4 to 238.8)	5 (12.7)	7	4	5	2
94 ¹ / ₁₆ to 96 (239.0 to 243.9)	5 (12.7)	8	4	6	2

For Same Side Controls

Finished Blind Width inches (cm)	Slat End Route inches (cm)	# of Ladders	# of Lifts	NoHoles # of Cords	# of Center Brackets
6 ¹ / ₁₆ to 26 (15.4 to 66.0)	6 (15.3)	2	2	4	0
26 ¹ / ₁₆ to 40 (66.2 to 101.6)	6 (15.3)	3	2	3	0
40 ¹ / ₁₆ to 54 (101.8 to 137.2)	6 (15.3)	4	4	4	1 over 48" (122.0 cm) FBW
54 ¹ / ₁₆ to 68 (137.3 to 172.7)	6 (15.3)	5	3	4	1
68 ¹ / ₁₆ to 80 (172.9 to 203.2)	6 (15.3)	6	4	4	2 over 72" (182.9 cm) FBW
80 ¹ / ₁₆ to 94 (203.4 to 238.8)	6 (15.3)	7	4	5	2
94 ¹ / ₁₆ to 96 (238.9 to 243.8)	6 (15.3)	8	4	6	2

NOTES:

1. Maximum spacing between ladders is 14" (35.6 cm).
2. Standard control positions: lift right/tilt left.
3. Maximum slat width is 96" (243.9 cm). Wider blinds must be multiple blinds on one headrail.
4. 7" (17.8 cm) to 8¹⁵/₁₆" (22.8 cm) not available with cloth tapes.
5. Cloth tape ladder quantity is the same as number of ladders listed above.

Traditions 2" (5.1 cm) and 2½" (6.4 cm) Composite Blinds with Cordless Lift

For Standard or Reverse Controls

Finished Blind Width inches (cm)	Slat End Route inches (cm)	# of Ladders	# of Lifts	# of Center Brackets
12 to 22 (30.5 to 55.9)	4 (10.2)	2	2	0
22 ¹ / ₁₆ to 38 (56.1 to 96.6)	5 (12.7)	3	3	0
38 ¹ / ₁₆ to 52 (96.7 to 132.1)	5 (12.7)	4	4	1 over 48" (122.0 cm) FBW
52 ¹ / ₁₆ to 66 (132.3 to 167.7)	5 (12.7)	5	5	1

NOTES:

1. Maximum spacing between ladders is 14" (35.6 cm).
2. Standard control positions: tilt left; tilt right is optional.
3. Maximum slat width is 66" (167.7 cm). Wider blinds must be multiple blinds on one headrail.
4. Cloth tape ladder quantity is the same as number of ladders listed above.

General Information

Slat Route and Ladder Count Charts

Take any inside mount deductions before determining ladder quantity (inside mount— $\frac{1}{2}$ " (1.3 cm); outside mount—no deduction).

Blinds with two lift cords will have two clear plastic cord stop beads located approximately 2" (5.1 cm) below the headrail. Cords will continue down, each ending in a tassel. Blinds with three or more lift cords will have the cords joined together with a tassel approximately 2" (5.1 cm) below the headrail. Two individual cords will continue down, each ending in a tassel.

Lake Forest® 2" (5.1 cm) and 2½" (6.4 cm) Premium Faux Wood and Faux Wood Blinds

For Standard or Reverse Controls

Finished Blind Width inches (cm)	Slat End Route inches (cm)	# of Ladders	# of Lifts	NoHoles™ # of Cords	# of Center Brackets
7 to 8 ¹⁵ / ₁₆ (17.8 to 22.8)	1¾ (3.5)	2	2	4	0
9 to 11 ¹⁵ / ₁₆ (22.9 to 30.4)	2¾ (6.1)	2	2	4	0
12 to 19 (30.5 to 48.3)	4 (10.2)	2	2	4	0
19 ¹ / ₁₆ to 30 (48.5 to 76.2)	4 (10.2)	3	2	3	0
30 ¹ / ₁₆ to 41 (76.4 to 104.2)	4 (10.2)	4	4	4	0
41 ¹ / ₁₆ to 52 (104.3 to 132.1)	4 (10.2)	5	3	4	1 over 48" (122.0 cm) FBW
52 ¹ / ₁₆ to 63 (132.3 to 160.1)	4 (10.2)	6	4	4	1
63 ¹ / ₁₆ to 74 (160.2 to 188.0)	4 (10.2)	7	4	5	1
74 ¹ / ₁₆ to 85 (188.2 to 215.9)	4 (10.2)	8	4	6	2
85 ¹ / ₁₆ to 96 (216.1 to 243.9)	4 (10.2)	9	4	5	2

NOTES:

- Maximum spacing between ladders is 11" (28.0 cm).
- Standard control positions: lift right/tilt left.
- Maximum slat width is 96" (243.9 cm). Wider blinds must be multiple blinds on one headrail.
- 7" (17.8 cm) to 8¹⁵/₁₆" (22.8 cm) not available with cloth tapes.
- Cloth tape ladder quantity is the same as number of ladders listed above.

Lake Forest 2" (5.1 cm) and 2½" (6.4 cm) Premium Faux Wood and Faux Wood Blinds with Cordless Lift

For Standard or Reverse Controls

Finished Blind Width inches (cm)	Slat End Route inches (cm)	# of Ladders	# of Lifts	# of Center Brackets
12 to 19 (30.5 to 48.3)	4 (10.2)	2	2	0
19 ¹ / ₁₆ to 30 (48.5 to 76.2)	4 (10.2)	3	2	0
30 ¹ / ₁₆ to 41 (76.4 to 104.2)	4 (10.2)	4	4	0
41 ¹ / ₁₆ to 52 (104.3 to 132.1)	4 (10.2)	5	3	1 over 48" (122.0 cm) FBW
52 ¹ / ₁₆ to 63 (132.3 to 160.1)	4 (10.2)	6	6	1

NOTES:

- Maximum spacing between ladders is 11" (28.0 cm).
- Standard control positions: tilt left; tilt right is optional.
- Maximum slat width is 63" (160.1 cm). Wider blinds must be multiple blinds on one headrail.
- Cloth tape ladder quantity is the same as number of ladders listed above.

General Information

Traditions® 1" (2.6 cm), 2" (5.1 cm), and 2 3/8" (6.1 cm) Wood and 2" (5.1 cm) and 2 3/8" (6.1 cm) Elite Wood Blinds Product Detail

2" (5.1 cm) and 2 3/8" (6.1 cm) Blinds

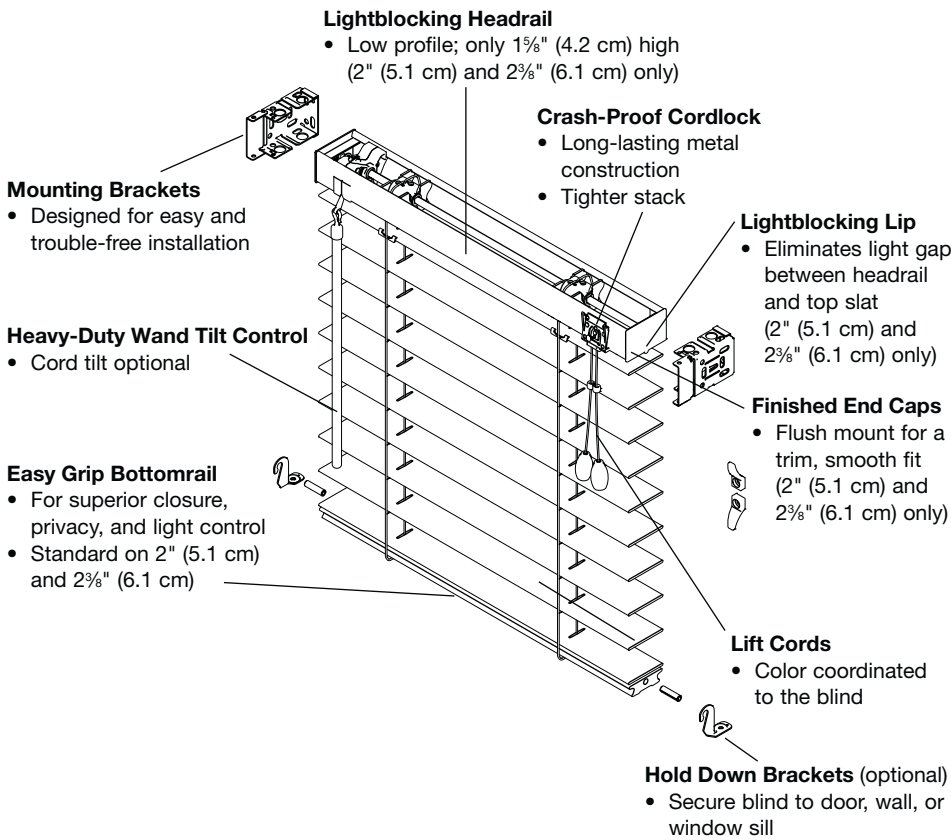

1" (2.6 cm) Blind

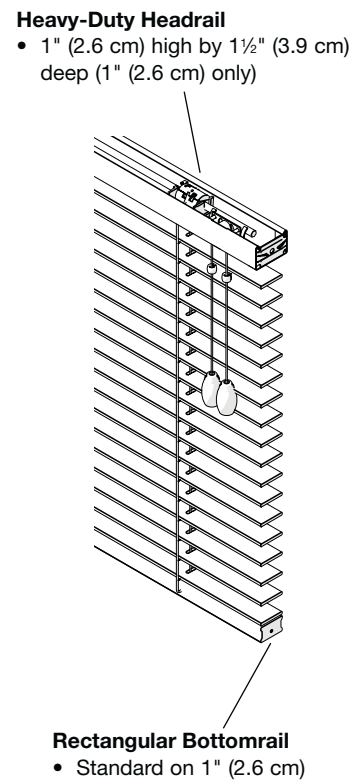

NoHoles™

- Available with 2" (5.1 cm) and 2 3/8" (6.1 cm)

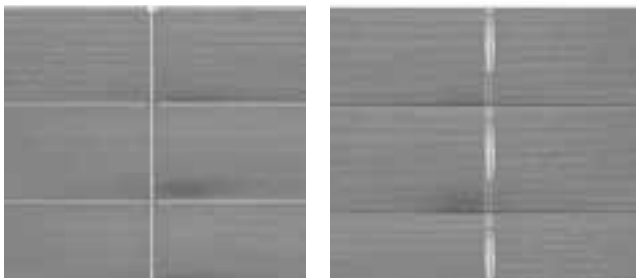

NoHoles

With Route Holes

Slat Comparison

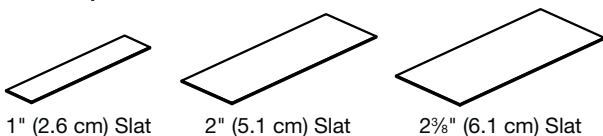

Cord Management Options

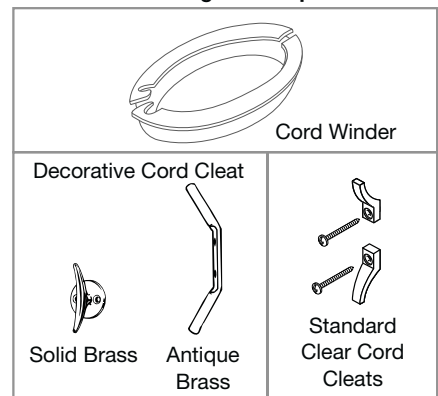

General Information

Cordless Lift Blinds Product Detail: Wood, Composite, and Faux Wood

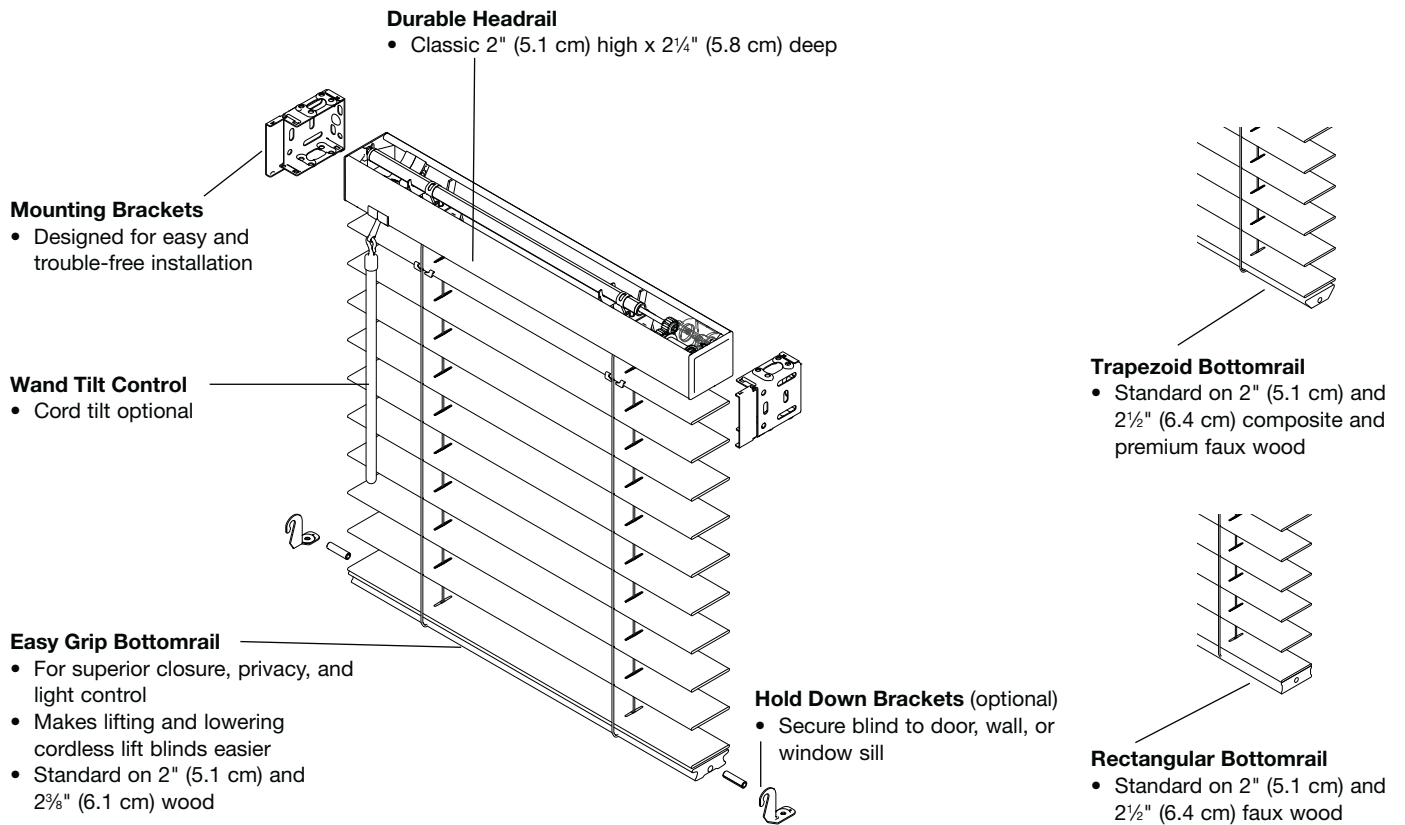

Pair cordless lift with wand tilt for a blind that eliminates operating cords and is safer for homes with children and pets, or pair it with cord tilt for fast, simple control.

To lower blind, simply pull down on the bottomrail. To raise the blind, simply guide the blind into the desired location by gently lifting the bottomrail.

Not available with sky pole option.

Slat Comparison

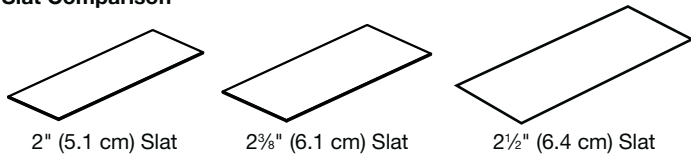

General Information

Traditions® 2" (5.1 cm) and 2½" (6.4 cm) Composite Blinds Product Detail

2" (5.1 cm) Slat Shown

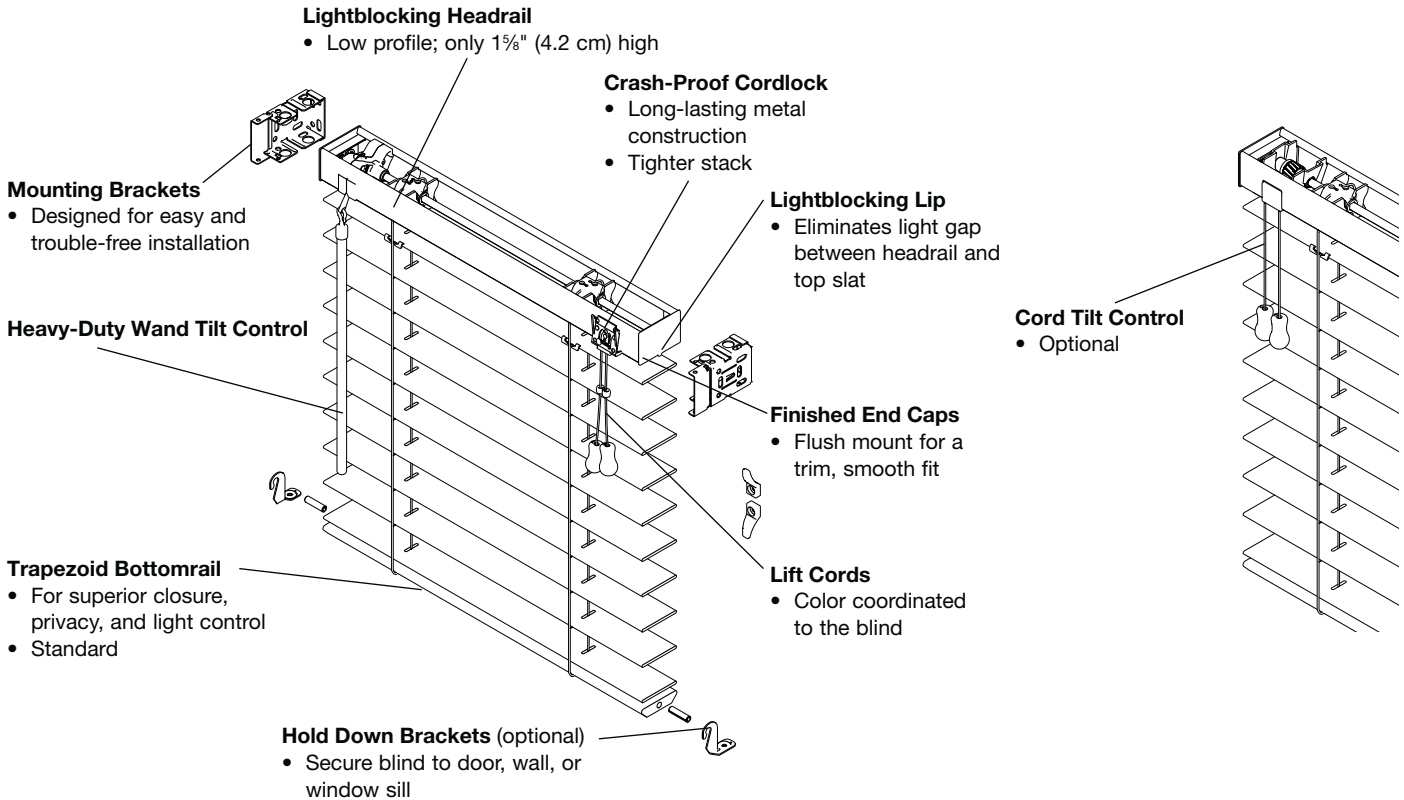

NoHoles™

- Available with 2" (5.1 cm) and 2½" (6.4 cm)

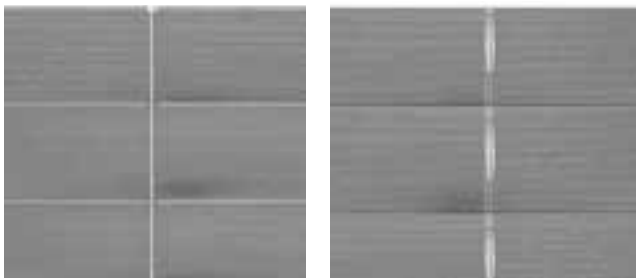

NoHoles

With Route Holes

Slat Comparison

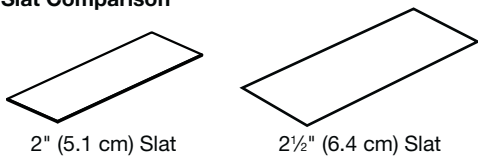

Cord Management Options

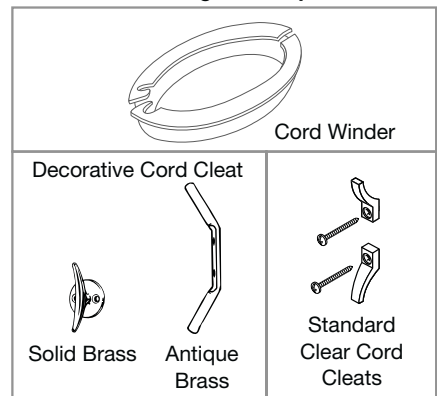

General Information

Lake Forest® 2" (5.1 cm) and 2½" (6.4 cm) Premium Faux Wood and Faux Wood Blinds Product Detail

2" (5.1 cm) Slat Shown

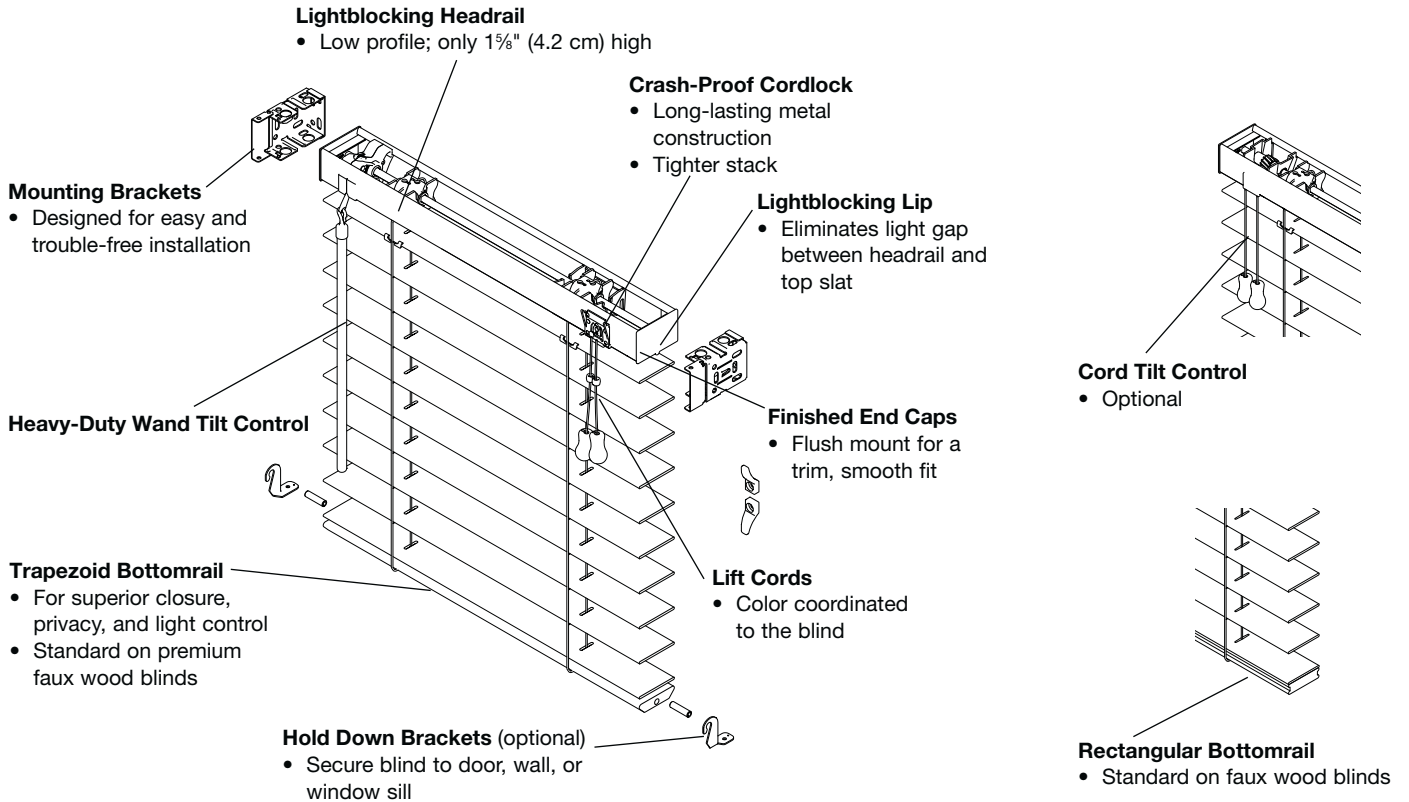

NoHoles™

- Available with 2" (5.1 cm) and 2½" (6.4 cm)

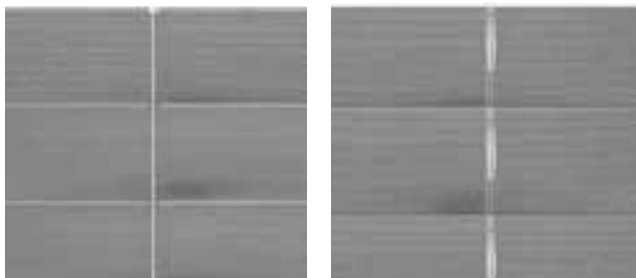

NoHoles

With Route Holes

Slat Comparison

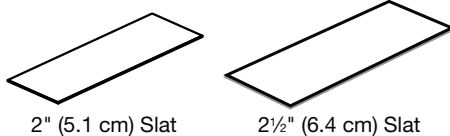

2" (5.1 cm) Slat

2½" (6.4 cm) Slat

Cord Management Options

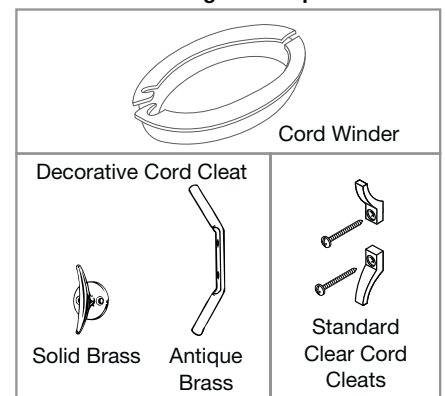

Wood Vertical Blinds

Features

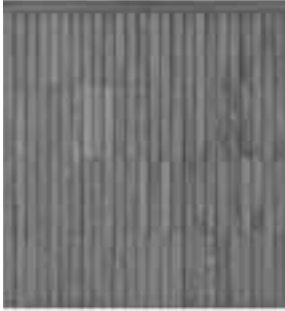

- Available in all Graber® Traditions® wood paints and stains
- Custom color available
- G-71 headrail features the patented pantograph traversing system to assure proportional spacing of vanes and automatically rotates the vanes when the cord is pulled to traverse the blind
- Unique design features multiple hinges on each vane to ensure they hang straight—without warping or twisting
- One-way or split stack available

Size Considerations

					
		Width		Height	
		Min Blind (exact) inches (cm)	Max Track inches (cm)	Min Blind inches (cm)	Max Blind inches (cm)
Blind Type	Price Group				
Elite Wood Vertical Blinds	J	9 (22.9)	144 (365.8)*	6 (15.3)	120 (304.8)

*Blinds over 96" (243.9 cm) wide: must be a split stack due to the weight of wood vane.

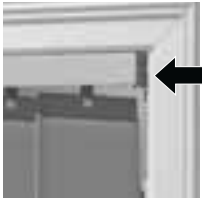
Depth Requirements for Inside Mount

					
		Partially recessed headrail in window casing/molding	Fully recessed headrail in window casing/molding		
Blind Type	Headrail Dimensions inches (cm)	Minimum Depth Mount inches (cm)	Flush with Casing inches (cm)	Depth Needed for Flush Mount Vane inches (cm)	Depth Needed for Flush Mount Valance inches (cm)
Elite Wood Vertical Blinds	$1\frac{3}{8} \times 1\frac{15}{16}$ (3.5 x 5.0)	2 $\frac{1}{8}$ (6.1)	3 (7.7)	3 $\frac{3}{4}$ (9.6)	4 $\frac{1}{2}$ (11.8)

Wood Vertical Blinds

Options: Cord and Chain Control



- Cord and chain control standard

Opening	Standard Controls	Optional Controls
Split Stack	Right	Left
One-Way Stack Right	Right	Left
One-Way Stack Left	Left	Right
Opposite Stack and Control	Left stack/right control	Right stack/left control

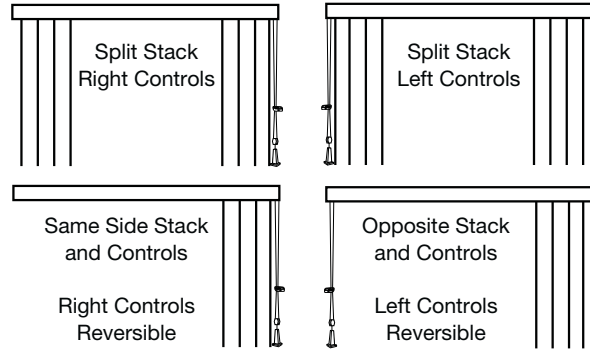

Chain and traversing cord must be at the same end of the track.

Paired Blinds

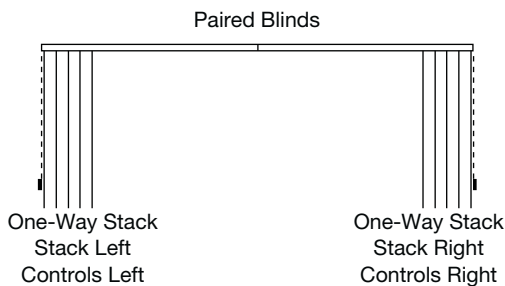

- **Price as two separate blinds**
- The appearance of a split stack blind can be achieved by pairing two individual one-way stack blinds; the center opening point can be either on center or off center
- Paired blinds can also be used when the required width is larger than the maximum width available for a single blind
- Specify paired blinds on your order
- Control locations must be same as stack
- Cut-outs not available
- Warranty will be voided if one-way stack is wider than 96"
- Available with one-way cord and chain only

Replacement Vane Ordering

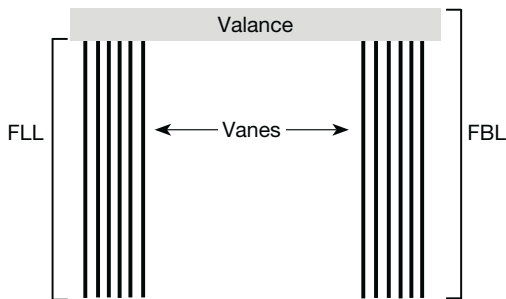

FLL = Finished vane length/height—the measurement from the top of the vane to the bottom of the vane. This measurement is approximately 2¼" (5.8 cm) less than the FBL.

FBL = Finished blind length/height—the measurement from the top of the headrail to the bottom of the vane.

- **For surcharge, see options pricing**

How to Measure a Replacement Existing Vane, No Changes

- Measure the vane(s) from tip to tip to determine the exact length/height (FLL)
- Finished vane length (FLL) is measured from top of metal vane clip to the bottom of the vane
- No additional deductions will be taken by manufacturing; vanes will be manufactured to the exact size provided
- Submit the measurement as exact height

How to Measure a Replacement Existing Vane, Changing the Height of the Vanes

- Measure from top of mounted headrail to bottom of location to be covered
- Record this measurement; this is the finished blind length/height (FBL)
- Manufacturing will take appropriate deduction so vanes will cover desired area

NOTE: When ordering replacement vanes only, hinge direction must be indicated (up or down).

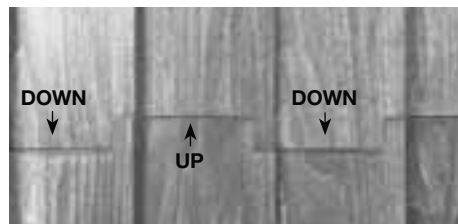

Wood Vertical Blinds

Stacking Chart and How to Measure for an Uncovered Window

Vertical Vane Stacking Chart				
Number of Vanes	One-Way		Split-Stack	
	CO inches (cm)	FBW inches (cm)	CO inches (cm)	FBW inches (cm)
3	7½ (18.1)	10½ (26.7)		
4	9¼ (24.8)	13% (34.7)	7% (20.1)	13¼ (33.7)
5	12% (31.5)	16% (42.6)		
6	15% (38.5)	19% (50.5)	13% (33.4)	19½ (49.6)
7	17% (45.1)	23 (58.5)		
8	20% (51.8)	26% (66.4)	18% (46.7)	25% (65.5)
9	23 (58.5)	29¼ (74.3)		
10	25% (65.1)	32% (82.3)	23% (60.1)	32 (81.3)
11	28% (71.8)	35% (90.2)		
12	30% (78.5)	38% (98.2)	29 (73.7)	38¼ (97.2)
13	33½ (85.1)	41% (106.1)		
14	36% (91.8)	44% (114.0)	34¼ (87.0)	44½ (113.1)
15	38% (98.5)	48 (122.0)		
16	41% (105.1)	51% (129.9)	39½ (100.4)	50% (129.0)
17	44 (111.8)	54¼ (137.8)		
18	46% (118.5)	57% (145.8)	44% (113.7)	57 (144.8)
19	49¼ (125.1)	60½ (153.7)		
20	51% (131.8)	63% (161.7)	50 (127.0)	63¼ (160.7)
21	54½ (138.5)	66% (169.6)		
22	57¼ (145.5)	69% (177.5)	55¼ (140.4)	69½ (176.6)
23	59% (152.1)	73 (185.5)		
24	62½ (158.8)	76% (193.4)	60½ (153.7)	75¼ (192.5)
25	65% (165.5)	79¼ (201.3)		
26	67% (172.1)	82% (209.3)	65% (167.1)	82 (208.3)
27	70% (178.8)	85½ (217.2)		
28	73 (185.5)	88% (225.2)	71% (180.7)	88¼ (224.2)
29	75% (192.1)	91% (233.1)		
30	78¼ (198.8)	94% (241.0)	76% (194.0)	94½ (240.1)
31	80% (205.5)	98 (249.0)		
32	83½ (212.1)	101% (256.9)	81½ (207.1)	100% (256.0)
33	86% (218.8)	104¼ (264.8)		
34	88% (225.5)	107% (272.8)	86% (220.7)	107 (271.8)
35	91% (232.1)	110½ (280.7)		
36	94 (238.8)	113% (288.7)	92% (234.0)	113¼ (287.7)
37	96% (245.5)	116% (296.6)		
38	99¼ (252.1)	119% (304.5)	97% (247.4)	119½ (303.6)
39	101% (258.8)	123 (312.5)		
40	104% (265.8)	126% (320.4)	102% (260.7)	125¼ (319.5)
41	107¼ (272.5)	129¼ (328.3)		
42	109% (279.1)	132% (336.3)	107% (274.1)	132 (335.3)
43	112½ (285.8)	135½ (344.2)		
44	115% (292.5)	138% (352.2)	113% (287.4)	138¼ (351.2)
45	117% (299.1)	141¼ (360.1)		
46	119½ (303.6)	144 (365.8)	117% (299.5)	144 (365.8)

1. Determine the clear opening width for one-way stack or split stack (see diagrams)—the additional 3" (7.7 cm) shown for privacy is recommended if ordering one-way stack.
2. Match the clear opening width dimension found under CO column. For even spacing, round up width measurement to the next size in the stack chart. Split stack will have even numbers of vanes.
3. Order the corresponding dimension found in the FBW (finished blind width) column.

EXAMPLE: One-way stack if determined width for clear opening window view is 54½" (138.5 cm), order width needed to provide full unobstructed view is 66¾" (169.6 cm).

NOTE: For one-way stack blinds add an additional 3" (7.7 cm) to the clear opening before calculating the finished blind width.

One-Way Stack Finished Blind Width (FBW)

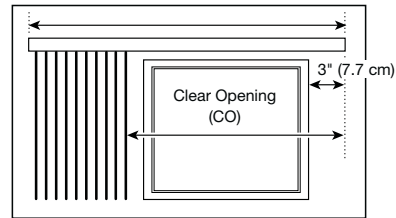

Split-Stack
(recommended for balanced appearance)
finished blind width (FBW)

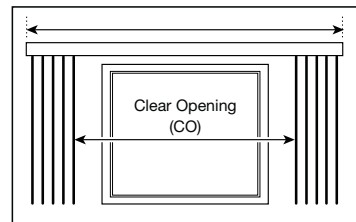

Wood Vertical Blinds

Product Detail

Pantograph Traversing System

- Keeps vanes evenly spaced whether blind is closed or partially open

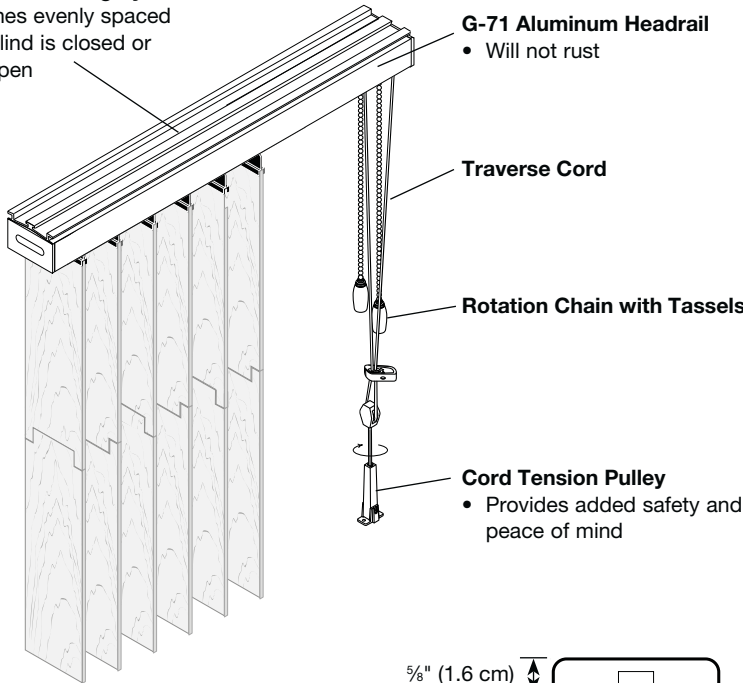

Vertical Vane Splice

- See chart for splices vs. height of vane

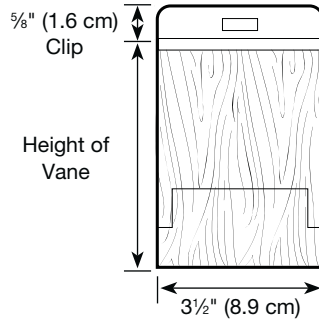

Height of Vanes without Metal Clip inches (cm)	Number of Splices Per Vane
0 to 24 (0 to 61.0)	0
$24\frac{1}{16}$ to $47\frac{1}{8}$ (61.2 to 119.7)	1
$47\frac{1}{16}$ to $70\frac{1}{2}$ (120.2 to 179.1)	2
$70\frac{9}{16}$ to $93\frac{3}{4}$ (179.3 to 238.2)	3
$93\frac{13}{16}$ to 117 (238.3 to 297.2)	4

Installation Hardware for Wood Vertical Blinds

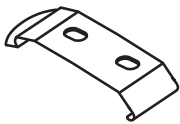

Track Clip for Inside or Ceiling Mount

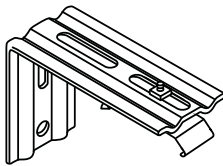

Angle Bracket for Outside or Wall Mount

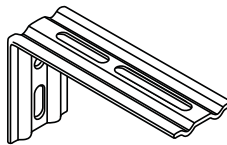

Optional 4" (10.2 cm) Angle Bracket

NOTE: Must be requested at time of order.

Mount	Standard/Optional	Hardware
Inside	Standard	Track clip
Outside	Standard	$3\frac{3}{4}$ " (8.3 cm) angle bracket with track clip
	Optional	4" (10.2 cm) angle bracket with track clip

Price Charts

Price Group A: Traditions® 1" (2.6 cm) Wood Blinds

Height up to inches (cm) ↓	Width up to inches (cm) →																
	12 (30.5)	24 (61.0)	32 (81.3)	36 (91.5)	42 (106.7)	48 (122.0)	54 (137.2)	60 (152.4)	66 (167.7)	72 (182.9)	78 (198.2)	84 (213.4)	90 (228.6)	96 (243.9)	106 (269.3)	116 (294.7)	120 (304.8)
30 (76.2)	\$164	147	177	207	226	243	276	322	334	345	416	442	471	495	546	596	647
36 (91.5)	186	168	198	230	251	272	317	367	381	392	473	493	525	552	608	664	721
42 (106.7)	202	185	219	253	279	301	352	407	417	441	514	556	594	623	688	752	818
48 (122.0)	219	200	240	277	305	334	388	446	471	495	571	624	668	702	776	849	923
54 (137.2)	239	222	264	300	338	367	429	483	525	556	640	690	736	773	854	935	1015
60 (152.4)	262	242	284	326	363	397	470	524	571	604	694	751	801	842	930	1016	1104
66 (167.7)	282	265	306	349	388	438	513	575	625	666	758	816	901	947	1046	1144	1243
72 (182.9)	305	287	326	375	424	473	557	626	664	705	805	868	932	977	1079	1181	1284
78 (198.2)	316	297	338	386	433	492	572	644	684	752	859	932	994	1044	1152	1258	1366
84 (213.4)	338	320	356	409	466	526	604	657	735	812	917	993	1063	1115	1231	1346	1462
90 (228.6)	361	343	380	436	493	557	638	694	779	856	965	1057	1130	1188	1311	1436	1559
96 (243.9)	374	355	392	447	514	581	670	740	837	913	1035	1121	1197	1260	1390	1520	1650
102 (259.1)	389	373	415	473	547	622	715	787	882	972	1097	1188	1274	1338	1477	1618	1758
108 (274.4)	409	391	431	496	574	652	749	824	930	1020	1148	1245	1335	1403	1550	1696	1844
114 (289.6)	426	408	452	525	606	688	788	872	975	1077	1216	1311	1407	1473	1626	1779	1931
120 (304.8)	447	429	472	547	631	721	825	898	1026	1124	1267	1373	1471	1547	1705	1865	2024

Add Surcharge to Blind Price

Multiple Blinds on One Headrail	\$44 (no charge to the right of the solid line)
---------------------------------	---

See options pricing for additional options and surcharges.

NOTE: Due to weight limitations, blinds to the right of the solid line must be manufactured as multiple blinds on one headrail. Single blinds over 43 square feet (3.99 square meters) will be heavy and difficult to lift and may have light gaps toward the bottom of the blind.

Add Surcharge to Blind Price

Width up to inches (cm) →	12 (30.5)	24 (61.0)	32 (81.3)	36 (91.5)	42 (106.7)	48 (122.0)	54 (137.2)	60 (152.4)	66 (167.7)	72 (182.9)	78 (198.2)	84 (213.4)	90 (228.6)	96 (243.9)	106 (269.3)	116 (294.7)	120 (304.8)
Legacy Valance	\$6	6	9	10	12	15	19	21	24	26	28	30	32	33	36	40	43
Symphony Valance	9	9	10	16	19	24	26	28	30	33	37	40	41	45	49	54	58

Colors

1" (2.6 cm) Paint Colors

Angora 0052
 Antique White 0026
 Base White 0051
 Dover White 0683
 Dovetail 0839
 Snowflake 0603

1" (2.6 cm) Stain Colors

Allspice 0821
 Golden Oak 0030
 Honey Maple 0013
 Natural 0007
 Roasted Chestnut 0849
 Saddle Brown 0694
 Walnut 0012
 Wheat 0710

NOTE: Color of wood may vary slightly due to the natural characteristics of wood. See "Wood Characteristics" section for more information.

Price Charts

Price Group B: Traditions® 2" (5.1 cm) Wood Blinds

Height up to inches (cm) ↓	Width up to inches (cm) →																
	12 (30.5)	24 (61.0)	32 (81.3)	36 (91.5)	42 (106.7)	48 (122.0)	54 (137.2)	60 (152.4)	66 (167.7)	72 (182.9)	78 (198.2)	84 (213.4)*	90 (228.6)	96 (243.9)	106 (269.3)	116 (294.7)	120 (304.8)
30 (76.2)	\$135	116	137	164	179	190	216	253	262	273	330	352	373	393	431	472	513
36 (91.5)	153	132	156	183	199	214	248	288	301	309	375	391	415	434	478	524	569
42 (106.7)	167	149	171	200	220	240	280	321	330	351	409	440	468	490	541	592	643
48 (122.0)	179	159	188	219	241	262	308	353	373	393	452	492	529	554	612	670	729
54 (137.2)	194	174	208	239	266	288	339	382	415	439	506	544	582	621	685	750	814
60 (152.4)	211	190	223	257	286	314	370	413	452	478	548	594	635	674	744	813	883
66 (167.7)	229	209	242	278	308	348	408	455	493	525	598	644	713	748	825	903	981
72 (182.9)	247	229	257	295	334	378	443	494	524	560	638	686	736	774	854	934	1015
78 (198.2)	254	235	266	304	342	389	453	509	540	596	682	736	785	824	910	996	1082
84 (213.4)	273	251	284	325	365	415	478	518	580	641	725	783	840	883	976	1066	1159
90 (228.6)*	289	270	300	343	391	443	505	548	613	679	763	836	893	939	1038	1135	1233
96 (243.9)	301	282	310	354	409	459	530	584	658	723	816	885	947	995	1099	1203	1306
102 (259.1)	314	294	328	375	431	489	564	622	696	768	868	938	1006	1056	1166	1277	1385
108 (274.4)	330	308	339	394	454	516	592	653	734	808	907	984	1056	1107	1223	1339	1454
114 (289.6)	342	322	356	415	479	541	624	689	770	851	960	1037	1110	1166	1287	1409	1530
120 (304.8)	357	338	373	431	500	570	654	707	811	888	999	1084	1163	1223	1349	1478	1605

Add Surcharge to Blind Price

Cordless Lift*	\$119
Cloth Tapes	Add 20%
Multiple Blinds on One Headrail	44 (no charge to the right of the solid line)

See options pricing for additional options and surcharges.

*Cordless lift blinds are available in the heavy outlined area above; multiple blinds on one headrail are required for cordless lift blinds over 84" (213.4 cm) wide. Cordless lift maximum height is 86" (218.5 cm).

NOTE: Due to weight limitations, blinds to right of solid line will be manufactured as multiple blinds on one headrail. Single blinds over 43 square feet (3.99 square meters) will be heavy and difficult to lift and may have light gaps toward the bottom of the blind.

Add Surcharge to Blind Price

Width up to inches (cm) →	12 (30.5)	24 (61.0)	32 (81.3)	36 (91.5)	42 (106.7)	48 (122.0)	54 (137.2)	60 (152.4)	66 (167.7)	72 (182.9)	78 (198.2)	84 (213.4)	90 (228.6)	96 (243.9)	106 (269.3)	116 (294.7)	120 (304.8)
Legacy Valance†	\$6	6	9	10	12	15	19	21	24	26	28	30	32	33	36	40	43
Symphony Valance	9	9	10	16	19	24	26	28	30	33	37	40	41	45	49	54	58

†No charge on cordless lift.

NOTE: Legacy, craftsman, or symphony valances are recommended with cordless lift for better headrail coverage.

Colors

2" (5.1 cm) Paint Colors

Angora 1052
 Antique White 1026
 Base White 1051
 Crisp White 1712
 Dover White 1683
 Dovetail 1839
 Grey Beige 1817
 Medium Grey 1841
 Medium Grey Sandblast. SB841
 Pearl 1840
 Snow White 1850
 Snowflake 1603
 Snowflake Sandblast. . SB603
 Stepping Stone 1889
 Stucco 1963

2" (5.1 cm) Stain Colors

Allspice 1821
 Cappuccino 1546
 Cherry Wood 1014
 Cognac 1465
 Dark Cherry 1316
 Dark Walnut 1641
 Espresso 1716
 Golden Oak 1030
 Harbor Grey 1761
 Henna 1949
 Homestead Oak 1943
 Honey Maple 1013
 Knotty Pine 1515
 Natural 1007
 Roasted Chestnut 1849
 Saddle Brown 1694
 Sienna 1685
 Timeless Grey 1847
 True Taupe 1848
 Truffle 1054
 Walnut 1012
 Wheat 1710

NOTE: Color of wood may vary slightly due to the natural characteristics of wood. See "Wood Characteristics" section for more information.

Price Charts

Price Group C: Traditions® 2 3/8" (6.1 cm) Wood Blinds

Height up to inches (cm) ↓	Width up to inches (cm) →																
	12 (30.5)	24 (61.0)	32 (81.3)	36 (91.5)	42 (106.7)	48 (122.0)	54 (137.2)	60 (152.4)	66 (167.7)	72 (182.9)	78 (198.2)	84 (213.4)*	90 (228.6)	96 (243.9)	106 (269.3)	116 (294.7)	120 (304.8)
30 (76.2)	\$155	133	157	188	207	219	249	290	302	315	380	404	429	452	495	542	590
36 (91.5)	175	151	181	210	228	246	286	332	346	356	431	449	477	499	550	602	655
42 (106.7)	192	171	197	229	253	276	322	369	380	402	470	506	537	564	623	681	739
48 (122.0)	207	184	216	251	277	302	355	406	429	452	519	566	608	638	704	771	837
54 (137.2)	224	201	239	275	306	332	391	440	477	505	582	625	669	714	789	862	937
60 (152.4)	243	219	256	295	328	360	426	475	519	550	629	684	730	775	855	936	1015
66 (167.7)	263	241	278	320	355	400	469	523	567	603	687	740	819	859	948	1038	1129
72 (182.9)	285	263	295	339	383	434	510	568	602	643	733	790	846	889	982	1075	1167
78 (198.2)	292	271	306	349	394	447	521	585	621	685	783	846	903	947	1045	1146	1244
84 (213.4)	315	289	326	375	419	477	550	597	667	737	835	902	966	1015	1121	1226	1333
90 (228.6)*	333	310	345	395	449	510	581	629	705	781	877	962	1027	1080	1193	1305	1418
96 (243.9)	346	324	357	408	470	529	609	672	756	832	939	1018	1089	1145	1264	1382	1503
102 (259.1)	360	338	379	431	495	563	648	715	799	884	998	1079	1157	1214	1341	1468	1592
108 (274.4)	380	355	391	453	522	593	681	750	844	929	1043	1132	1214	1272	1406	1539	1671
114 (289.6)	394	371	410	477	551	623	718	793	886	979	1103	1192	1277	1341	1480	1620	1759
120 (304.8)	411	389	429	495	575	656	751	814	932	1021	1149	1247	1338	1406	1553	1699	1846

Add Surcharge to Blind Price

Cordless Lift*	\$119
Cloth Tapes	Add 20%
Multiple Blinds on One Headrail	44 (no charge to the right of the solid line)

See options pricing for additional options and surcharges.

*Cordless lift blinds are available in the heavy outlined area above; multiple blinds on one headrail are required for cordless lift blinds over 84" (213.4 cm) wide. Cordless lift maximum height is 86" (218.5 cm).

NOTE: Due to weight limitations, blinds to right of solid line will be manufactured as multiple blinds on one headrail. Single blinds over 43 square feet (3.99 square meters) will be heavy and difficult to lift and may have light gaps toward the bottom of the blind.

Add Surcharge to Blind Price

Width up to inches (cm) →	12 (30.5)	24 (61.0)	32 (81.3)	36 (91.5)	42 (106.7)	48 (122.0)	54 (137.2)	60 (152.4)	66 (167.7)	72 (182.9)	78 (198.2)	84 (213.4)	90 (228.6)	96 (243.9)	106 (269.3)	116 (294.7)	120 (304.8)
Symphony Valance	\$9	9	10	16	19	24	26	28	30	33	37	40	41	45	49	54	58

NOTE: Legacy, craftsman, or symphony valances are recommended with 2 3/8" (6.1 cm) blinds or cordless lift for better headrail coverage.

Colors

2 3/8" (6.1 cm) Paint Colors		2 3/8" (6.1 cm) Stain Colors	
Antique White	3026	Golden Oak	3030
Base White	3051	Honey Maple	3013
Dover White	3683	Natural	3007
Dovetail	3839	Saddle Brown	3694
Medium Grey	3841	Timeless Grey	3847
Snowflake	3603	True Taupe	3848
Stepping Stone	3889	Walnut	3012
		Wheat	3710

NOTE: Color of wood may vary slightly due to the natural characteristics of wood. See "Wood Characteristics" section for more information.

If the stained or painted color is not listed above, please enter order as elite wood in the color and slat size needed. Order does not need to be processed as custom color.

Price Charts

Price Group D: Traditions® 2" (5.1 cm) Wood Blinds—Unique Finishes: Barnwood, Distressed

Height up to inches (cm) ↓	Width up to inches (cm) →																
	12 (30.5)	24 (61.0)	32 (81.3)	36 (91.5)	42 (106.7)	48 (122.0)	54 (137.2)	60 (152.4)	66 (167.7)	72 (182.9)	78 (198.2)	84 (213.4)*	90 (228.6)	96 (243.9)	106 (269.3)	116 (294.7)	120 (304.8)
30 (76.2)	\$172	153	184	217	236	256	288	338	349	362	437	464	495	518	572	626	680
36 (91.5)	195	177	208	240	265	285	331	382	397	411	498	515	551	576	638	698	760
42 (106.7)	212	193	227	267	292	318	371	427	437	463	540	583	621	653	720	788	856
48 (122.0)	229	210	249	291	320	349	408	466	495	518	599	654	700	736	815	893	970
54 (137.2)	250	231	275	316	350	382	449	506	551	582	670	722	772	822	906	993	1078
60 (152.4)	275	256	296	341	381	418	494	549	599	632	727	788	840	894	986	1078	1170
66 (167.7)	295	277	323	369	408	459	538	604	655	697	794	854	945	994	1097	1200	1304
72 (182.9)	321	300	341	392	441	498	583	657	695	741	845	910	977	1028	1134	1241	1347
78 (198.2)	332	314	350	405	456	513	602	675	718	790	901	975	1043	1093	1206	1321	1435
84 (213.4)	354	336	375	431	489	552	632	686	770	851	963	1042	1114	1170	1293	1415	1538
90 (228.6)*	376	356	396	456	515	583	669	727	817	897	1011	1108	1187	1245	1374	1506	1636
96 (243.9)	392	374	412	469	540	610	701	776	875	958	1085	1174	1257	1319	1456	1595	1734
102 (259.1)	410	391	435	498	573	651	748	824	923	1016	1150	1244	1335	1402	1549	1695	1841
108 (274.4)	429	410	453	521	603	683	785	864	972	1071	1203	1305	1400	1471	1623	1777	1930
114 (289.6)	447	429	474	551	636	720	825	914	1019	1129	1274	1374	1473	1548	1707	1869	2030
120 (304.8)	469	449	496	573	664	755	865	940	1076	1179	1327	1439	1541	1620	1789	1958	2127

Add Surcharge to Blind Price

Cordless Lift*	\$119
Cloth Tapes	Add 20%
Multiple Blinds on One Headrail	44 (no charge to the right of the solid line)

See options pricing for additional options and surcharges.
 *Cordless lift blinds are available in the heavy outlined area above; multiple blinds on one headrail are required for cordless lift blinds over 84" (213.4 cm) wide. Cordless lift maximum height is 86" (218.5 cm).

NOTE: Due to weight limitations, blinds to right of solid line will be manufactured as multiple blinds on one headrail. Single blinds over 43 square feet (3.99 square meters) will be heavy and difficult to lift and may have light gaps toward the bottom of the blind.

Colors

2" (5.1 cm) Barnwood Colors Medium Pewter Barnwood. 1049 Windswept Barnwood. . . 1072	2" (5.1 cm) Distressed Colors Distressed Smoky Coal. 1572 Distressed Twig. 1070
--	--

NOTE: Color of wood may vary slightly due to the natural characteristics of wood. See "Wood Characteristics" section for more information.

Price Charts

Price Group E: 2" (5.1 cm) Elite Wood Blinds

Height up to inches (cm) ↓	Width up to inches (cm) →																
	12 (30.5)	24 (61.0)	32 (81.3)	36 (91.5)	42 (106.7)	48 (122.0)	54 (137.2)	60 (152.4)	66 (167.7)	72 (182.9)	78 (198.2)	84 (213.4)*	90 (228.6)	96 (243.9)	106 (269.3)	116 (294.7)	120 (304.8)
30 (76.2)	\$181	162	180	226	264	299	332	361	394	434	465	496	535	571	632	692	753
36 (91.5)	186	168	204	243	284	322	360	396	432	468	506	538	570	610	673	737	800
42 (106.7)	204	185	229	274	318	358	401	442	483	520	560	600	638	678	750	822	892
48 (122.0)	221	202	253	295	341	388	437	482	530	578	623	673	721	769	850	930	1010
54 (137.2)	241	224	274	327	380	432	487	542	597	648	703	756	811	867	957	1046	1136
60 (152.4)	264	243	299	360	422	482	542	600	661	721	781	839	901	960	1059	1160	1260
66 (167.7)	281	264	330	396	462	530	597	661	725	793	857	924	992	1058	1168	1279	1389
72 (182.9)	309	289	360	432	506	578	648	721	793	865	938	1007	1081	1152	1272	1393	1513
78 (198.2)	332	314	388	468	546	623	703	781	857	938	1019	1094	1171	1272	1405	1538	1670
84 (213.4)	355	336	422	506	589	673	756	839	924	1007	1094	1176	1284	1370	1512	1654	1797
90 (228.6)*	379	360	452	542	628	721	811	901	992	1081	1171	1284	1375	1467	1620	1772	1925
96 (243.9)	402	383	482	578	673	768	865	960	1060	1152	1272	1370	1466	1566	1729	1892	2054
102 (259.1)	428	410	509	612	713	815	920	1021	1122	1247	1351	1455	1560	1663	1837	2011	2184
108 (274.4)	452	432	542	648	756	865	976	1081	1189	1321	1431	1540	1650	1761	1945	2128	2312
114 (289.6)	475	456	569	685	799	913	1027	1140	1277	1393	1511	1626	1742	1860	2054	2247	2442
120 (304.8)	500	482	600	721	839	960	1081	1203	1345	1467	1590	1711	1833	1956	2159	2360	2564

Add Surcharge to Blind Price

Cordless Lift*	\$119
Cloth Tapes	Add 20%
Custom Color	149 net per color
Multiple Blinds on One Headrail	44 (no charge to the right of the solid line)

See options pricing for additional options and surcharges.

*Cordless lift blinds are available in the heavy outlined area above; multiple blinds on one headrail are required for cordless lift blinds over 84" (213.4 cm) wide. Cordless lift maximum height is 86" (218.5 cm).

NOTE: Due to weight limitations, blinds to right of solid line will be manufactured as multiple blinds on one headrail. Single blinds over 43 square feet (3.99 square meters) will be heavy and difficult to lift and may have light gaps toward the bottom of the blind.

NOTE: Legacy, craftsman, or symphony valances are recommended with cordless lift for better headrail coverage.

Colors

2" (5.1 cm) Paint Colors		2" (5.1 cm) Stain Colors		2" (5.1 cm) Rustic Stain Colors	
Angora	1052	Allspice	1821	Honey Maple	1013
Antique White	1026	Cappuccino	1546	Knotty Pine	1515
Base White	1051	Cherry Wood	1014	Natural	1007
Crisp White	1712	Cognac	1465	Roasted Chestnut	1849
Custom Color Paint . . .	CUSP	Custom Color Stain . . .	CUSS	Saddle Brown	1694
Dover White	1683	Dark Cherry	1316	Sienna	1685
Dovetail	1839	Dark Walnut	1641	Timeless Grey	1847
Grey Beige	1817	Espresso	1716	True Taupe	1848
Medium Grey	1841	Golden Oak	1030	Truffle	1054
Pearl	1840	Harbor Grey	1761	Walnut	1012
Snow White	1850	Henna	1949	Wheat	1710
Snowflake	1603	Homestead Oak	1943		
Stepping Stone	1889				
Stucco	1963				

NOTE: Color of wood may vary slightly due to the natural characteristics of wood. See "Wood Characteristics" section for more information.

Price Charts

Price Group F: 2 3/8" (6.1 cm) Elite Wood Blinds

Height up to inches (cm) ↓	Width up to inches (cm) →																
	12 (30.5)	24 (61.0)	32 (81.3)	36 (91.5)	42 (106.7)	48 (122.0)	54 (137.2)	60 (152.4)	66 (167.7)	72 (182.9)	78 (198.2)	84 (213.4)*	90 (228.6)	96 (243.9)	106 (269.3)	116 (294.7)	120 (304.8)
30 (76.2)	\$211	196	208	260	304	346	383	415	455	503	535	572	617	659	729	798	868
36 (91.5)	218	202	235	284	330	372	414	458	500	540	584	622	657	703	776	850	923
42 (106.7)	230	212	263	314	364	413	460	508	555	600	646	691	733	782	862	945	1025
48 (122.0)	249	233	288	342	395	449	504	554	608	666	720	775	834	888	980	1073	1165
54 (137.2)	274	257	314	376	438	500	560	625	688	748	809	870	936	996	1100	1204	1306
60 (152.4)	300	284	346	414	485	554	625	692	763	834	900	967	1038	1106	1221	1336	1451
66 (167.7)	321	304	380	458	533	608	688	763	837	912	990	1064	1143	1219	1346	1472	1600
72 (182.9)	350	334	414	500	584	666	748	834	912	994	1079	1162	1245	1326	1464	1602	1740
78 (198.2)	376	358	449	540	628	720	809	900	990	1079	1173	1259	1349	1467	1620	1773	1926
84 (213.4)	404	387	485	584	677	775	870	967	1064	1162	1259	1355	1479	1577	1743	1908	2073
90 (228.6)*	430	414	520	625	725	834	936	1038	1143	1245	1349	1479	1585	1692	1867	2044	2220
96 (243.9)	458	441	554	666	775	887	994	1106	1221	1326	1467	1577	1691	1805	1993	2180	2367
102 (259.1)	490	473	587	705	821	942	1060	1176	1293	1438	1560	1677	1798	1919	2120	2320	2520
108 (274.4)	516	500	625	748	870	994	1120	1245	1371	1522	1649	1775	1904	2030	2242	2452	2664
114 (289.6)	545	526	656	789	921	1052	1183	1315	1472	1605	1740	1875	2006	2143	2365	2587	2810
120 (304.8)	570	554	692	834	967	1106	1245	1387	1548	1692	1831	1971	2112	2253	2489	2724	2961

Add Surcharge to Blind Price

Cordless Lift*	\$119
Cloth Tapes	Add 20%
Custom Color	149 net per color
Multiple Blinds on One Headrail	44 (no charge to the right of the solid line)

See options pricing for additional options and surcharges.
 *Cordless lift blinds are available in the heavy outlined area above; multiple blinds on one headrail are required for cordless lift blinds over 84" (213.4 cm) wide. Cordless lift maximum height is 86" (218.5 cm).

NOTE: Due to weight limitations, blinds to right of solid line will be manufactured as multiple blinds on one headrail. Single blinds over 43 square feet (3.99 square meters) will be heavy and difficult to lift and may have light gaps toward the bottom of the blind.

NOTE: Legacy, craftsman, or symphony valances are recommended with 2 3/8" (6.1 cm) blinds or cordless lift for better headrail coverage.

Colors

2 3/8" (6.1 cm) Paint Colors

Angora 3052
 Antique White 3026
 Base White 3051
 Crisp White 3712
 Custom Color Paint . . . CUSP
 Dover White 3683
 Dovetail 3839
 Grey Beige 3817
 Medium Grey 3841
 Pearl 3840
 Snow White 3850
 Snowflake 3603
 Stepping Stone 3889
 Stucco 3963

2 3/8" (6.1 cm) Stain Colors

Allspice 3821
 Cappuccino 3546
 Cherry Wood 3014
 Cognac 3465
 Custom Color Stain . . . CUSS
 Dark Cherry 3316
 Dark Walnut 3641
 Espresso 3716
 Golden Oak 3030
 Harbor Grey 3761
 Henna 3949
 Homestead Oak 3943
 Honey Maple 3013
 Knotty Pine 3515
 Natural 3007
 Roasted Chestnut 3849
 Saddle Brown 3694
 Sienna 3685
 Timeless Grey 3847
 True Taupe 3848
 Truffle 3054
 Walnut 3012
 Wheat 3710

NOTE: Color of wood may vary slightly due to the natural characteristics of wood. See "Wood Characteristics" section for more information.

Price Charts

Price Group G: 2" (5.1 cm) Elite Wood Blinds—Authentic Hardwoods

Height up to inches (cm) ↓	Width up to inches (cm) →																
	12 (30.5)	24 (61.0)	32 (81.3)	36 (91.5)	42 (106.7)	48 (122.0)	54 (137.2)	60 (152.4)	66 (167.7)	72 (182.9)	78 (198.2)	84 (213.4)*	90 (228.6)	96 (243.9)	106 (269.3)	116 (294.7)	120 (304.8)
30 (76.2)	\$416	395	475	524	571	617	699	819	846	874	1055	1124	1188	1254	1384	1513	1642
36 (91.5)	470	449	533	581	637	689	800	927	967	992	1159	1248	1323	1397	1543	1691	1837
42 (106.7)	513	493	584	644	707	767	897	1029	1058	1120	1303	1407	1491	1574	1739	1904	2068
48 (122.0)	550	533	637	703	776	852	989	1128	1196	1254	1443	1579	1678	1778	1963	2150	2336
54 (137.2)	606	586	698	765	852	927	1086	1224	1330	1404	1620	1743	1850	1957	2160	2363	2566
60 (152.4)	663	645	764	832	918	1014	1190	1330	1443	1529	1759	1897	2014	2129	2352	2574	2797
66 (167.7)	713	693	815	890	989	1109	1300	1454	1583	1684	1919	2066	2231	2395	2643	2892	3142
72 (182.9)*	777	758	880	953	1070	1205	1409	1586	1680	1787	2037	2200	2337	2476	2735	2995	3254
78 (198.2)*	798	778	905	980	1100	1244	1449	1630	1738	1910	2175	2351	2496	2640	2915	3189	3464
84 (213.4)	855	834	963	1038	1181	1332	1527	1665	1855	2052	2326	2508	2665	2822	3116	3409	3704
90 (228.6)	913	892	1024	1100	1248	1410	1616	1759	1974	2174	2444	2672	2840	3008	3321	3635	3947
96 (243.9)	943	926	1055	1133	1303	1474	1697	1873	2106	2311	2619	2834	3037	3238	3577	3915	4253
102 (259.1)	987	967	1113	1198	1388	1572	1805	1988	2229	2459	2777	2990	3205	3418	3774	4131	4487
108 (274.4)	1035	1015	1166	1257	1453	1648	1897	2087	2348	2585	2801	3016	3232	3446	3807	4167	4527
114 (289.6)	1076	1055	1232	1330	1532	1739	1996	2206	2467	2724	2952	3178	3406	3633	4009	4388	4766
120 (304.8)	1128	1106	1286	1388	1606	1822	2091	2269	2585	2822	3057	3312	3564	3821	4218	4616	5013

Add Surcharge to Blind Price

Cordless Lift*	\$119
Cloth Tapes	Add 20%
Multiple Blinds on One Headrail	44 (no charge to the right of the solid line)

See options pricing for additional options and surcharges.

*Cordless lift blinds are available in the heavy outlined area above; multiple blinds on one headrail are required for cordless lift blinds over 84" (213.4 cm) wide. Cordless lift maximum height is 78" (198.2 cm), 68" (172.8 cm) for Walnut.

NOTE: Due to weight limitations, blinds to right of solid line will be manufactured as multiple blinds on one headrail. Single blinds over 43 square feet (3.99 square meters) will be heavy and difficult to lift and may have light gaps toward the bottom of the blind.

Colors

Cherry C007
 Maple. M007
 Walnut W007

NOTE: Elite Walnut, Maple, and Cherry will have the unique natural variations of these beautiful hardwoods—these variations are to be expected. Blinds made from these materials will undergo a degree of color change over time, further enhancing the beauty of the wood.

Price Charts

Price Group H: Angle Top or Bottom, Trapezoid, Triangle, Octagon, and Arched Blinds

Height up to inches (cm) ↓	Width up to inches (cm) →												
	24 (61.0)	32 (81.3)	36 (91.5)	42 (106.7)	48 (122.0)	54 (137.2)	60 (152.4)	66 (167.7)	72 (182.9)	78 (198.2)	84 (213.4)	90 (228.6)	96 (243.9)
30 (76.2)	\$1894	1923	1957	1984	2013	2042	2074	2102	2131	2160	2192	2221	2250
36 (91.5)	1911	1942	1980	2013	2045	2078	2115	2147	2181	2214	2250	2282	2314
42 (106.7)	1927	1964	2006	2042	2079	2115	2157	2192	2229	2265	2307	2343	2380
48 (122.0)	1944	1984	2031	2071	2112	2153	2198	2237	2280	2320	2365	2406	2445
54 (137.2)	1963	2007	2057	2102	2147	2192	2243	2287	2334	2379	2429	2473	2518
61 (155.0)	1978	2028	2083	2131	2181	2229	2284	2332	2382	2432	2487	2581	2689
66 (167.7)	1995	2049	2107	2160	2214	2267	2325	2377	2432	2504	2623	2746	2867
73 (185.5)	2011	2071	2131	2188	2246	2303	2366	2423	2481	2648	2777	2908	3035
78 (198.2)	2027	2090	2157	2217	2279	2341	2408	2468	2531	2793	2929	3071	3255
84 (213.4)	2045	2109	2181	2246	2312	2377	2449	2513	2580	2929	3078	3276	3430
90 (228.6)	2061	2131	2207	2274	2344	2415	2488	2558	2630	3071	3276	3441	3607
96 (243.9)	2078	2150	2229	2303	2377	2451	2530	2602	2678	3255	3430	3606	3788
102 (259.1)	2093	2172	2255	2332	2411	2488	2571	2650	2729	3399	3585	3776	3963
108 (274.4)	2109	2192	2280	2361	2444	2524	2612	2695	2839	3541	3738	3939	4140
114 (289.6)	2128	2214	2305	2389	2475	2561	2653	2760	2970	3685	3894	4106	4317
120 (304.8)	2143	2233	2329	2418	2508	2599	2695	2882	3105	3828	4049	4269	4492

Add Surcharge to Blind Price

Custom Color	\$149 net per color
---------------------	---------------------

Template Service Fee (see options section for explanation): \$25 net
See options pricing for additional options and surcharges.

Price Group I: Circle and Oval Blinds

Diameter up to inches (cm) ↓	Width up to inches (cm) →								
	24 (61.0)	32 (81.3)	36 (91.5)	42 (106.7)	48 (122.0)	54 (137.2)	60 (152.4)	66 (167.7)	72 (182.9)
72 (182.9)	\$4371	4424	4516	4641	4742	4902	5023	5152	5359

Add Surcharge to Blind Price

Custom Color	\$149 net per color
---------------------	---------------------

Template Service Fee (see options section for explanation): \$25 net
See options pricing for additional options and surcharges.

Colors

2" (5.1 cm) Paint Colors

Angora	1052
Antique White	1026
Base White	1051
Crisp White	1712
Custom Color Paint . . .	CUSP
Dover White	1683
Dovetail	1839
Grey Beige	1817
Medium Grey	1841
Pearl	1840
Snow White	1850
Snowflake	1603
Stepping Stone	1889
Stucco	1963

2" (5.1 cm) Stain Colors

Allspice	1821	Honey Maple	1013
Cappuccino	1546	Knotty Pine	1515
Cherry Wood	1014	Natural	1007
Cognac	1465	Roasted Chestnut	1849
Custom Color Stain . . .	CUSS	Saddle Brown	1694
Dark Cherry	1316	Sienna	1685
Dark Walnut	1641	Timeless Grey	1847
Espresso	1716	True Taupe	1848
Golden Oak	1030	Truffle	1054
Harbor Grey	1761	Walnut	1012
Henna	1949	Wheat	1710
Homestead Oak	1943		

NOTE: Color of wood may vary slightly due to the natural characteristics of wood. See "Wood Characteristics" section for more information.
Use appropriate wood color numbers for 2 3/8" (6.1 cm) slats, see price chart for this product.

Price Charts

Price Group J: Elite Wood Vertical Blinds

Height up to inches (cm) ↓	Width up to inches (cm) →									
	27 (68.6)	39 (99.1)	52 (132.1)	66 (167.7)	78 (198.2)	96 (243.9)	108 (274.4)	120 (304.8)	132 (335.3)	144 (365.8)
36 (91.5)	\$540	776	1026	1321	1445	1669	1956	2129	2212	2370
48 (122.0)	659	937	1248	1566	1630	1992	2214	2459	2680	2926
60 (152.4)	772	1110	1465	1908	1927	2363	2637	2924	3191	3478
72 (182.9)	877	1268	1685	2008	2253	2766	3052	3389	3706	4043
84 (213.4)	998	1436	1908	2280	2525	3138	3471	3862	4212	4600
96 (243.9)	1108	1598	1942	2548	2857	3512	3890	4324	4727	5158
108 (274.4)	1246	1802	2184	2867	3183	3919	4379	4861	5314	
120 (304.8)	1388	1958	2433	3185	3540	4355	4866	5405		

Add Surcharge to Blind Price	
Custom Color	\$149 net per color

See options pricing for additional options and surcharges.

Add Surcharge to Blind Price

Width up to inches (cm) →	27 (68.6)	39 (99.1)	52 (132.1)	66 (167.7)	78 (198.2)	96 (243.9)	108 (274.4)	120 (304.8)	132 (335.3)	144 (365.8)
Symphony Valance	\$10	19	26	30	37	45	49	58	62	66

NOTE: Legacy, craftsman, or symphony valances are recommended with wood vertical blinds for better headrail coverage.

Colors

Paint Colors

Angora	1052
Antique White	1026
Base White	1051
Crisp White	1712
Custom Color Paint . . .	CUSP
Dover White	1683
Dovetail	1839
Grey Beige	1817
Medium Grey	1841
Pearl	1840
Snow White	1850
Snowflake	1603
Stepping Stone	1889
Stucco	1963

Stain Colors

Allspice	1821	Honey Maple	1013
Cappuccino	1546	Knotty Pine	1515
Cherry Wood	1014	Natural	1007
Cognac	1465	Roasted Chestnut	1849
Custom Color Stain . . .	CUSS	Saddle Brown	1694
Dark Cherry	1316	Sienna	1685
Dark Walnut	1641	Timeless Grey	1847
Espresso	1716	True Taupe	1848
Golden Oak	1030	Truffle	1054
Harbor Grey	1761	Walnut	1012
Henna	1949	Wheat	1710
Homestead Oak	1943		

NOTE: Color of wood may vary slightly due to the natural characteristics of wood. See "Wood Characteristics" section for more information.

Price Charts

Price Group K: Traditions® 2" (5.1 cm) Composite Blinds

Height up to inches (cm) ↓	Width up to inches (cm) →																
	12 (30.5)	24 (61.0)	32 (81.3)	36 (91.5)	42 (106.7)	48 (122.0)	54 (137.2)	60 (152.4)	66 (167.7)*	72 (182.9)	78 (198.2)	84 (213.4)	90 (228.6)	96 (243.9)	106 (269.3)	116 (294.7)	120 (304.8)
30 (76.2)	\$135	115	137	162	178	191	213	252	261	271	326	346	370	386	427	468	511
36 (91.5)	153	133	155	181	196	212	246	283	299	306	371	384	410	433	478	525	571
42 (106.7)	165	143	172	198	218	236	275	316	326	345	403	435	464	486	536	588	639
48 (122.0)	179	157	188	214	239	261	305	349	370	386	446	487	522	551	607	665	722
54 (137.2)	193	174	202	235	262	283	335	377	410	435	501	537	574	604	667	729	793
60 (152.4)	212	191	223	254	281	311	369	408	446	473	543	586	626	655	725	795	864
66 (167.7)	228	203	240	273	305	341	401	451	487	518	592	636	706	738	815	889	965
72 (182.9)*	250	230	254	295	329	371	435	488	517	553	628	678	727	763	842	924	1005
78 (198.2)	254	234	262	303	337	383	446	504	532	588	672	725	776	816	900	985	1072
84 (213.4)	271	251	278	317	365	412	472	514	574	635	717	776	828	871	963	1056	1148
90 (228.6)	290	268	297	340	384	435	497	543	609	669	754	826	885	927	1025	1123	1221
96 (243.9)	299	276	307	350	403	454	523	577	650	712	808	877	935	982	1087	1192	1295
102 (259.1)	312	293	324	371	430	485	556	614	686	759	856	927	995	1045	1154	1263	1373
108 (274.4)	326	306	336	387	447	511	586	644	724	797	897	973	1043	1092	1208	1322	1437
114 (289.6)	339	317	352	410	473	535	615	680	760	841	949	1023	1094	1151	1271	1391	1511
120 (304.8)	357	335	370	430	494	564	645	702	799	879	986	1072	1150	1207	1332	1459	1585

Add Surcharge to Blind Price

Cordless Lift*	\$119
Cloth Tapes	Add 20%
Multiple Blinds on One Headrail	44 (no charge to the right of the solid line)

See options pricing for additional options and surcharges.
 *Cordless lift blinds are available in the heavy outlined area above; multiple blinds on one headrail are required for cordless lift blinds over 66" (167.7 cm) wide. Cordless lift maximum height is 72" (182.9 cm).

NOTE: Due to weight limitations, blinds to right of solid line will be manufactured as multiple blinds on one headrail. Single blinds over 43 square feet (3.99 square meters) will be heavy and difficult to lift and may have light gaps toward the bottom of the blind.

NOTE: Majestic valance is recommended with cordless lift for better headrail coverage.

Colors

2" (5.1 cm) Colors

- Antique White 2026
- Base White 2051
- Creamy White 2729
- Seattle Grey 2174
- Silk White 2922

Price Charts

Price Group L: Traditions® 2½" (6.4 cm) Composite Blinds

Height up to inches (cm) ↓	Width up to inches (cm) →																
	12 (30.5)	24 (61.0)	32 (81.3)	36 (91.5)	42 (106.7)	48 (122.0)	54 (137.2)	60 (152.4)	66 (167.7)*	72 (182.9)	78 (198.2)	84 (213.4)	90 (228.6)	96 (243.9)	106 (269.3)	116 (294.7)	120 (304.8)
30 (76.2)	\$155	133	157	186	204	220	245	290	300	312	375	398	425	444	492	538	587
36 (91.5)	176	153	179	208	226	244	283	325	343	352	426	442	471	498	551	604	656
42 (106.7)	190	164	198	228	250	272	316	364	375	397	463	501	534	559	616	677	735
48 (122.0)	205	180	215	246	274	300	351	401	425	444	513	561	601	633	698	765	830
54 (137.2)	222	201	232	271	301	325	385	434	471	501	576	618	660	695	767	839	911
60 (152.4)	244	220	256	292	323	357	424	470	513	544	624	674	720	754	834	914	993
66 (167.7)	262	233	275	314	351	392	461	518	561	596	680	731	811	849	937	1022	1109
72 (182.9)*	287	264	292	340	377	426	501	562	595	636	723	780	836	877	969	1062	1156
78 (198.2)	292	270	301	349	389	441	513	579	612	677	773	834	892	938	1036	1132	1233
84 (213.4)	312	289	320	365	420	474	543	591	660	730	825	892	952	1002	1108	1214	1320
90 (228.6)	333	307	342	391	442	501	572	624	700	769	867	950	1018	1066	1178	1292	1404
96 (243.9)	343	317	354	402	463	522	602	664	748	818	929	1009	1074	1130	1250	1371	1490
102 (259.1)	359	337	373	426	494	558	639	706	789	874	985	1066	1143	1201	1328	1453	1580
108 (274.4)	375	352	386	445	514	587	674	740	833	917	1031	1120	1200	1257	1389	1521	1653
114 (289.6)	390	365	405	471	544	615	707	783	875	968	1091	1177	1259	1324	1462	1600	1737
120 (304.8)	411	385	425	494	568	648	741	807	919	1011	1133	1233	1322	1388	1532	1677	1823

Add Surcharge to Blind Price

Cordless Lift*	\$119
Cloth Tapes	Add 20%
Multiple Blinds on One Headrail	44 (no charge to the right of the solid line)

See options pricing for additional options and surcharges.
 *Cordless lift blinds are available in the heavy outlined area above; multiple blinds on one headrail are required for cordless lift blinds over 66" (167.7 cm) wide. Cordless lift maximum height is 72" (182.9 cm).

NOTE: Due to weight limitations, blinds to right of solid line will be manufactured as multiple blinds on one headrail. Single blinds over 43 square feet (3.99 square meters) will be heavy and difficult to lift and may have light gaps toward the bottom of the blind.

NOTE: Majestic valance is recommended with 2½" (6.4 cm) blinds or cordless lift for better headrail coverage.

Colors

2½" (6.4 cm) Colors

- Antique White 7026
- Base White 7051
- Creamy White 7729
- Seattle Grey 7174
- Silk White 7922

Price Charts

Price Group M: Lake Forest® 2" (5.1 cm) Premium Faux Wood Blinds

Height up to inches (cm) ↓	Width up to inches (cm) →																
	12 (30.5)	24 (61.0)	32 (81.3)	36 (91.5)	42 (106.7)	48 (122.0)	54 (137.2)	60 (152.4)*	66 (167.7)	72 (182.9)	78 (198.2)	84 (213.4)	90 (228.6)	96 (243.9)	106 (269.3)	116 (294.7)	120 (304.8)
30 (76.2)	\$124	106	124	147	163	174	196	232	238	245	298	317	337	354	393	430	469
36 (91.5)	141	122	140	165	179	194	224	257	273	283	338	352	374	393	433	475	518
42 (106.7)	151	131	158	179	199	217	252	289	298	315	366	397	421	440	488	537	584
48 (122.0)	163	141	174	197	219	238	277	318	337	354	408	444	476	499	552	605	657
54 (137.2)	179	161	184	216	239	257	305	344	374	397	455	491	524	551	609	668	726
60 (152.4)	193	174	200	234	256	286	334	373	408	430	494	535	571	598	662	725	789
66 (167.7)	206	187	221	249	277	314	364	409	444	472	539	581	641	672	743	814	884
72 (182.9)*	227	204	234	265	300	339	397	446	472	502	573	617	663	696	769	842	914
78 (198.2)	233	212	239	275	307	349	408	459	487	538	613	662	705	752	831	909	989
84 (213.4)	251	232	254	294	332	374	428	468	524	578	655	705	759	814	899	983	1068
90 (228.6)	263	244	272	307	352	398	454	494	554	612	685	762	840	916	1012	1108	1203
96 (243.9)	275	254	283	319	366	416	476	527	594	651	736	824	911	996	1100	1206	1311
102 (259.1)	285	263	296	338	386	440	505	559	625	692	756	851	947	1041	1152	1263	1374
108 (274.4)	301	283	306	356	409	463	535	587	662	736	813	886	959	1052	1164	1276	1388
114 (289.6)	311	293	322	374	431	488	561	619	679	747	817	904	991	1078	1191	1305	1419
120 (304.8)	322	304	338	386	452	513	589	637	689	767	847	926	1008	1086	1201	1316	1430

Add Surcharge to Blind Price

Cordless Lift*	\$119
Cloth Tapes	Add 20%
Multiple Blinds on One Headrail	44 (no charge to the right of the solid line)

See options pricing for additional options and surcharges.
 *Cordless lift blinds are available in the heavy outlined area above; multiple blinds on one headrail are required for cordless lift blinds over 63" (160.1 cm) wide. Cordless lift maximum height is 72" (182.9 cm).

NOTE: Due to weight limitations, blinds to right of solid line will be manufactured as multiple blinds on one headrail. Single blinds over 43 square feet (3.99 square meters) will be heavy and difficult to lift and may have light gaps toward the bottom of the blind.

NOTE: Majestic valance is recommended with cordless lift for better headrail coverage.

Colors: Woodgrain

2" (5.1 cm) Colors

- Cognac 2465
- Dark Cherry 2316
- Golden Oak 2030
- Honey Maple 2013
- Misty Grey 2230
- Moonshine 2738
- Morel 2706
- Natural 2007
- Phantom 2707
- Saddle Brown 2694
- Sienna 2685
- Walnut 2012
- Wheat 2710

Price Charts

Price Group N: Lake Forest® 2½" (6.4 cm) Premium Faux Wood Blinds

Height up to inches (cm) ↓	Width up to inches (cm) →																
	12 (30.5)	24 (61.0)	32 (81.3)	36 (91.5)	42 (106.7)	48 (122.0)	54 (137.2)	60 (152.4)*	66 (167.7)	72 (182.9)	78 (198.2)	84 (213.4)	90 (228.6)	96 (243.9)	106 (269.3)	116 (294.7)	120 (304.8)
30 (76.2)	\$143	122	143	169	187	199	224	267	273	282	342	364	386	407	451	494	539
36 (91.5)	162	141	161	190	206	222	259	296	314	325	388	404	430	451	499	547	595
42 (106.7)	174	151	182	206	230	250	289	332	342	362	421	457	485	506	562	617	672
48 (122.0)	187	162	199	227	252	273	320	365	386	407	469	510	548	574	635	695	756
54 (137.2)	206	185	212	249	275	296	350	396	430	457	524	564	602	634	701	769	835
60 (152.4)	221	199	231	270	295	329	384	429	469	494	569	614	656	689	761	834	906
66 (167.7)	237	216	254	286	320	361	419	470	510	542	619	668	737	773	854	936	1016
72 (182.9)*	260	234	270	305	344	389	457	512	542	576	659	710	762	800	883	968	1051
78 (198.2)	268	244	275	317	353	402	469	528	560	618	704	761	811	865	955	1045	1137
84 (213.4)	288	267	293	339	383	430	492	538	602	664	754	811	872	936	1033	1131	1229
90 (228.6)	303	281	312	353	404	458	523	569	637	703	789	878	967	1053	1165	1275	1384
96 (243.9)	317	293	325	366	421	479	548	607	683	749	846	947	1047	1146	1265	1386	1508
102 (259.1)	327	303	341	388	446	506	581	644	718	796	869	979	1088	1196	1323	1453	1581
108 (274.4)	347	325	352	410	470	532	614	674	761	846	935	1018	1103	1210	1338	1466	1597
114 (289.6)	359	338	371	430	495	562	646	713	780	860	941	1041	1140	1240	1371	1500	1632
120 (304.8)	371	349	388	446	520	591	677	734	792	881	974	1066	1158	1249	1382	1513	1645

Add Surcharge to Blind Price

Cordless Lift*	\$119
Cloth Tapes	Add 20%
Multiple Blinds on One Headrail	44 (no charge to the right of the solid line)

See options pricing for additional options and surcharges.

*Cordless lift blinds are available in the heavy outlined area above; multiple blinds on one headrail are required for cordless lift blinds over 63" (160.1 cm) wide. Cordless lift maximum height is 72" (182.9 cm).

NOTE: Due to weight limitations, blinds to right of solid line will be manufactured as multiple blinds on one headrail. Single blinds over 43 square feet (3.99 square meters) will be heavy and difficult to lift and may have light gaps toward the bottom of the blind.

NOTE: Majestic valance is recommended with 2½" (6.4 cm) blinds or cordless lift for better headrail coverage.

Colors: Woodgrain

2½" (6.4 cm) Colors

Cognac	7465
Dark Cherry	7316
Golden Oak	7030
Honey Maple	7013
Misty Grey	7230
Moonshine	7738
Morel	7706
Natural	7007
Phantom	7707
Saddle Brown	7694
Sienna	7685
Walnut	7012
Wheat	7710

Price Charts

Price Group O: Lake Forest® 2" (5.1 cm) Faux Wood Blinds

Height up to inches (cm) ↓	Width up to inches (cm) →																
	12 (30.5)	24 (61.0)	32 (81.3)	36 (91.5)	42 (106.7)	48 (122.0)	54 (137.2)	60 (152.4)*	66 (167.7)	72 (182.9)	78 (198.2)	84 (213.4)	90 (228.6)	96 (243.9)	106 (269.3)	116 (294.7)	120 (304.8)
30 (76.2)	\$117	98	114	134	147	160	180	209	220	226	272	290	305	320	354	389	422
36 (91.5)	130	111	129	152	164	177	202	235	250	254	307	319	343	359	397	436	475
42 (106.7)	139	120	141	164	183	197	230	262	272	289	336	362	385	405	447	488	531
48 (122.0)	149	130	160	182	198	220	253	292	305	320	371	407	433	457	505	552	601
54 (137.2)	164	142	168	194	221	235	281	314	343	362	416	448	480	502	552	604	656
60 (152.4)	178	160	184	213	234	259	304	341	371	393	452	487	523	546	603	661	718
66 (167.7)	190	172	199	229	253	286	332	373	407	430	491	530	585	614	678	741	805
72 (182.9)*	208	188	213	244	274	309	362	409	430	461	525	562	605	637	703	770	837
78 (198.2)	213	193	221	251	283	318	371	419	444	490	558	604	646	685	756	826	897
84 (213.4)	230	209	232	267	303	343	392	425	480	527	596	646	693	743	818	895	972
90 (228.6)	243	224	249	283	319	363	415	452	506	556	626	695	767	836	923	1009	1095
96 (243.9)	251	232	254	293	336	377	433	482	541	594	672	752	832	908	1003	1100	1195
102 (259.1)	259	240	270	307	354	405	463	512	573	631	690	777	864	950	1052	1152	1251
108 (274.4)	275	254	282	322	373	422	487	536	604	672	741	807	877	961	1063	1164	1265
114 (289.6)	285	263	295	343	394	446	514	564	619	683	746	825	904	983	1085	1187	1290
120 (304.8)	298	279	307	354	414	469	538	583	628	701	774	846	919	993	1098	1200	1304

Add Surcharge to Blind Price

Cordless Lift*	\$119
Cloth Tapes	Add 20%
Multiple Blinds on One Headrail	44 (no charge to the right of the solid line)

See options pricing for additional options and surcharges.
 *Cordless lift blinds are available in the heavy outlined area above; multiple blinds on one headrail are required for cordless lift blinds over 63" (160.1 cm) wide. Cordless lift maximum height is 72" (182.9 cm).

NOTE: Due to weight limitations, blinds to right of solid line will be manufactured as multiple blinds on one headrail. Single blinds over 43 square feet (3.99 square meters) will be heavy and difficult to lift and may have light gaps toward the bottom of the blind.

NOTE: Majestic valance is recommended with cordless lift for better headrail coverage.

Colors: Smooth and Textured

2" (5.1 cm) Colors

- Almond 5724
- Buttermilk 5078
- Buttermilk Textured 5953
- Coconut 5630
- Coconut Textured 5299
- Marshmallow 5742
- Milky Way 5058
- Milky Way Textured 5304
- Seattle Grey 5174
- White 5035
- White Textured 5951

*Classic valance will be textured to coordinate with textured slats. Majestic valance will be color coordinated in a smooth finish.

Price Charts

Price Group P: Lake Forest® 2½" (6.4 cm) Faux Wood Blinds

Height up to inches (cm) ↓	Width up to inches (cm) →																
	12 (30.5)	24 (61.0)	32 (81.3)	36 (91.5)	42 (106.7)	48 (122.0)	54 (137.2)	60 (152.4)*	66 (167.7)	72 (182.9)	78 (198.2)	84 (213.4)	90 (228.6)	96 (243.9)	106 (269.3)	116 (294.7)	120 (304.8)
30 (76.2)	\$133	112	131	153	169	183	206	239	252	257	310	332	350	366	406	446	484
36 (91.5)	149	127	147	174	187	202	231	271	285	290	352	364	393	410	455	499	543
42 (106.7)	158	138	161	187	209	226	263	300	310	331	384	414	440	463	512	559	608
48 (122.0)	171	149	183	208	227	252	289	333	350	366	425	465	495	521	579	633	688
54 (137.2)	187	162	194	222	253	271	321	359	393	414	476	513	548	573	633	691	750
60 (152.4)	204	183	210	245	267	297	348	389	425	450	517	558	597	624	690	757	822
66 (167.7)	219	197	228	262	289	328	381	427	465	492	562	607	670	702	776	848	922
72 (182.9)*	238	215	245	279	314	354	414	468	492	528	600	644	693	729	805	882	959
78 (198.2)	245	221	253	287	325	363	425	480	509	561	638	691	739	784	865	945	1025
84 (213.4)	263	239	265	306	347	393	449	486	548	603	682	739	793	849	937	1024	1113
90 (228.6)	278	256	284	325	364	415	475	517	580	636	716	795	878	957	1056	1154	1253
96 (243.9)	287	265	290	334	384	432	495	552	619	680	769	861	952	1040	1148	1258	1367
102 (259.1)	297	275	308	352	406	463	530	585	656	723	790	889	989	1088	1203	1319	1431
108 (274.4)	315	290	323	369	427	484	558	614	691	769	848	924	1003	1100	1217	1332	1448
114 (289.6)	327	301	337	393	451	510	589	646	708	782	854	944	1035	1125	1242	1359	1477
120 (304.8)	341	320	352	406	474	537	616	668	719	802	887	968	1051	1137	1256	1374	1492

Add Surcharge to Blind Price

Cordless Lift*	\$119
Cloth Tapes	Add 20%
Multiple Blinds on One Headrail	44 (no charge to the right of the solid line)

See options pricing for additional options and surcharges.

*Cordless lift blinds are available in the heavy outlined area above; multiple blinds on one headrail are required for cordless lift blinds over 63" (160.1 cm) wide. Cordless lift maximum height is 72" (182.9 cm).

NOTE: Due to weight limitations, blinds to right of solid line will be manufactured as multiple blinds on one headrail. Single blinds over 43 square feet (3.99 square meters) will be heavy and difficult to lift and may have light gaps toward the bottom of the blind.

NOTE: Majestic valance is recommended with 2½" (6.4 cm) blinds or cordless lift for better headrail coverage.

Colors: Smooth and Textured

2½" (6.4 cm) Colors

Buttermilk 7078
 Coconut 7630
 Coconut Textured 7299
 Marshmallow 7742
 Milky Way 7058
 Seattle Grey 7774
 White 7035

*Classic valance will be textured to coordinate with textured slats. Majestic valance will be color coordinated in a smooth finish.

Options Pricing

Option	Surcharge
Accent Color (elite blinds only)	\$51 per blind
Bay and Corner Window	No charge
Cloth Tapes	20%
Cord Management Cleats	Clear: standard Cord winder: \$8 Solid brass cleat: \$10 Antique brass cleat: \$5
Cordless Lift	\$119 per blind
Custom Color	\$149 net per color
Cut-Outs (not available with cordless lift or wood verticals)	\$67
Decorative Tassels	\$35 per blind panel (standard on elite blinds and specialty shapes)
High Gloss Finish (elite blinds only)	No charge
Hold Down Brackets	No charge
Incline Wire Blind (elite blinds only)	Double the price of the blind
Motorized Tilt	See motorization price list
Multiple Blinds on One Headrail	Right of the solid line on the price charts: no charge Left of the solid line on the price charts: \$44
NoHoles™ (not available with cordless lift)	No charge
Projection Brackets (2¾" (7.0 cm) and 4¾" (12.1 cm))	No charge (outside mount only)
Sandblast Finish (2" (5.1 cm) elite blinds only)	No charge
Shims (⅜" (0.5 cm))	Standard on all outside mount 2⅝" (6.1 cm) and 2½" (6.4 cm) slat blinds
Sky Poles	3 to 6½ feet (1.0 to 2.0 m): \$46 5 to 9½ feet (1.6 to 2.9 m): \$70
Specialty Shapes (elite blinds only)	See price charts
Template Fee Service	\$25 net
Valance Keystones	\$22 each when requested without a splice
Wood Cornices and Valances	See cornices and valances price list
Wood Vertical Vanes Only	\$21 per linear foot

GRABER®

Grabert is a brand of Springs Window Fashions, the Best Experience Company 

Grabert and the Grabert logo are registered trademarks of Springs Window Fashions, LLC.

19-0216-04 (02/19) 18-10474|S18-9689