

# ALUMINUM HORIZONTAL BLINDS

## Table of Contents

### Features and Size Considerations

1" (2.6 cm) Supreme Cordless, 1" (2.6 cm) Supreme, 1" (2.6 cm) Classics, 1" (2.6 cm) Insignia™,	
½" (1.3 cm) Supreme Micro, 2" (5.1 cm) Grandeur™	2
Cord Lift Blinds, Depth Requirements for Inside Mount	3
Cordless Lift Blinds, Depth Requirements for Inside Mount	4

### Options

Summary	5
Cord Tilt Controls	6
Cordless Lift	6
Motorized Tilt Control	7
Hidden Holes	8
Inverted Slats	8
Control Length Chart for Cords and Wands	8
Multiple Blinds on One Headrail	9
Multi-Colored Striped Blinds	10
Cloth Tapes and Colors	10
Cut-out Blinds	11
Bay and Corner Windows	12
Specialty Shapes: Skylights Dual Headrail or Incline Wire Blinds	13-14
Specialty Shapes: Arches	15
Specialty Shapes: Circles	15
Specialty Shapes: Side Cuts, Angle Top, Angle Bottom	16
Specialty Shapes: Octagons, Triangles, Other Shapes	17
Making a Template for Specialty Shape Windows	18
Using the Template Service	18

### General Information

Aluminum Color Assortment	19
Color Coordination Chart: ½" (1.3 cm) and 1" (2.6 cm) Aluminum	20
Color Coordination Chart: 2" (5.1 cm) Grandeur Aluminum	21
Ladder Color Coordination: Dual Headrail	21
Stack Height Chart	22
Slat Count Chart	23
Slat Route and Ladder Count Chart, Cordless Supreme, Supreme with Side Mount Brackets, Supreme, Classics, Insignia, Micro Supreme with Side Mount Brackets, Micro Supreme, Grandeur 2" (5.1 cm) Aluminum	24-25
½" (1.3 cm) Micro Supreme and 1" Supreme Product Detail	26
1" (2.6 cm) Cordless Supreme Product Detail	27
1" (2.6 cm) Classics Product Detail	28
1" (2.6 cm) Insignia Product Detail	29
2" (5.1 cm) Grandeur Product Detail	29

### Price Charts and Options Pricing

Price Group A: 1" (2.6 cm) Cordless Supreme	31
Price Group B: 1" (2.6 cm) Supreme	32
Price Group C: 1" (2.6 cm) Classics	33
Price Group D: 1" (2.6 cm) Insignia	34
Price Group E: ½" (1.3 cm) Micro Supreme	35
Price Group F: 2" (5.1 cm) Grandeur	36
Price Group G: 1" (2.6 cm) Skylights	37
Price Group H: 1" (2.6 cm) Skylights—Incline Wire Specialty Shapes	38-39
Price Group I: Arches	40
Price Group J: Circles	41
Price Group K: Side Cuts, Inverted Triangles, Angle Top and Bottom	42
Price Group L: Octagons, Triangles	43
Options Pricing	44

# GRABER®

UNITED STATES PRICE LIST • FEBRUARY 2019

## Features

### 1" (2.6 cm) Supreme Cordless

- Great for children's rooms and play areas
- Choose .006 or .008 gauge 1" (2.6 cm) aluminum slats
- Cordless lift system allows blind to be raised and lowered easily
- Improved safety for households with children and pets
- Eliminates unsightly cords
- Hidden holes option for additional light control and privacy
- Patented, sleek headrail design features a lightblocking lip, requires no valance (1½" x 2⅜" (3.9 cm x 5.6 cm) aluminum)
- Hidden headrail brackets reduce light gaps
- Gear-driven motor provides smooth, quiet operation
- Our painting process allows slats to resist dust, stains, scratches, mold, and mildew
- Color coordinated components provide a finished look
- Cordless handle keeps the blind clean

### 1" (2.6 cm) Supreme

- The ultimate in light control
- Choose .006 or .008 gauge 1" (2.6 cm) aluminum slats
- Offers the most options in colors to suit any decor
- Sleek lightblocking headrail requires no valance (1" x 1½" (2.6 cm x 3.9 cm) steel)
- Tighter ladder spacing provides greater lightblocking ability
- Hidden headrail brackets reduce light gaps
- Hidden Holes option for additional light control and privacy
- Clutch wand tilt releases to prevent damage
- Crash-proof cordlock and bottomrail bumpers prevent sill damage
- Precision-machined roller system makes it easier to raise blinds
- Our painting process allows slats to resist dust, stains, scratches, mold, and mildew
- Color coordinated components provide a finished look

### 1" (2.6 cm) Classics

- Box brackets make it a snap to install
- Available in skylights and other specialty shapes
- Choose .006 or .008 gauge 1" (2.6 cm) aluminum slats
- 1" x 1½" (2.6 cm x 3.9 cm) steel rectangular headrail
- Deluxe two-slat valance provides a more attractive look
- Clutch wand tilt releases to prevent damage
- Crash-proof cordlock and bottomrail bumpers prevent sill damage
- Less porous paint on slats resists dust, stains, scratches, mold, and mildew
- Color coordinated components provide a finished look

### 1" (2.6 cm) Insignia™

- The best value
- Fits in windows with narrow jams
- .006 gauge 1" (2.6 cm) aluminum slats
- 1" x 1" (2.6 cm x 2.6 cm) steel square headrail requires minimal depth for a flush mount
- Box brackets make it a snap to install
- Two-slat valance provides a more attractive look
- Clutch wand tilt releases to prevent damage
- Crash-proof cordlock prevents sill damage
- Our painting process allows slats to resist dust, stains, scratches, mold, and mildew



### ½" (1.3 cm) Supreme Micro

- Great for French doors and small windows
- .006 gauge ½" (1.3 cm) aluminum slats
- Sleek lightblocking headrail requires no valance (1" x 1½" (2.6 cm x 3.9 cm) steel)
- Hidden headrail brackets reduce light gaps
- Clutch wand tilt releases to prevent damage
- Our painting process allows slats to resist dust, stains, scratches, mold, and mildew
- Color coordinated components provide a finished look

### 2" (5.1 cm) Grandeur™

- Proportionate for large windows
- Maximizes view to outside when slats are open
- .008 gauge 2" (5.1 cm) aluminum slats
- Patented SureClose® headrail (1⅝" x 2¼" (4.2 cm x (5.8 cm)) with premium lightblocking features
- Box brackets make it a snap to install
- Decorative cloth tapes available
- Deluxe channel panel valance provides a sleek finished look
- Crash-proof cordlock prevents sill damage
- Our painting process allows slats to resist dust, stains, scratches, mold, and mildew
- Color coordinated components provide a finished look
- Standard return size for 2" (5.1 cm) aluminum is 3⅞" (7.9 cm)

## Size Considerations

Cord Lift Blinds										
<b>Styles</b>	<b>Price Group</b>									
		Cord Lift Blinds				Cord Lift Multiple Blinds on One Headrail				
		Width		Height		Width			Height	
		Minimum* inches (cm)	Maximum inches (cm)	Minimum inches (cm)	Maximum inches (cm)	Minimum Panel* inches (cm)	Maximum Panel inches (cm)	Maximum Blind inches (cm)	Minimum Blind inches (cm)	Maximum Blind inches (cm)
½" (1.3 cm) Micro Supreme	E	5½ (14.0) <sup>a</sup>	120 (304.8)	12 (30.5)	5½ (14.0)–22 (55.9): 96 (243.9) <sup>b</sup> 22⅞ (56.1)–120 (304.8): 144 (365.8)	9 (22.9)	120 (304.8)	192 (487.7)	12 (30.5)	108 (274.4)
1" (2.6 cm) Classics	C	5½ (14.0) <sup>a</sup>	142 (360.7)	12 (30.5)	126 (320.1)	9 (22.9)	142 (360.7)	192 (487.7)	12 (30.5)	126 (320.1)
1" (2.6 cm) Insignia™	D	5½ (14.0) <sup>a</sup>	120 (304.8)	12 (30.5)	126 (320.1)	9 (22.9)	142 (360.7)	192 (487.7)	12 (30.5)	126 (320.1)
1" (2.6 cm) Supreme .006 and .008 Gauge	B	5½ (14.0) <sup>a</sup>	142 (360.7)	12 (30.5)	5½ (14.0)–11⅞ (30.4): 132 (335.3) 12 (30.5)–35 (88.9): 168 (426.8) 35⅞ (89.1)–143¾ (365.2): 240 (609.6)	9 (22.9)	142 (360.7)	192 (487.7)	12 (30.5)	126 (320.1)
2" (5.1 cm) Grandeur™	F	9 (22.9) <sup>†</sup>	142 (360.7)	12 (30.5)	126 (320.1)	9 (22.9) <sup>†</sup>	142 (360.7)	142 (360.7)	12 (30.5)	126 (320.1)

\*For all inside mount applications—½" (1.3 cm) deduction is taken by manufacturer on overall width; supreme and supreme micro—⅜" (1.0 cm).

<sup>a</sup>5½" (14.0 cm) to 8⅞" (22.8 cm) center tilt only

<sup>†</sup>9" (22.9 cm) outside mount, 9½" (24.2 cm) inside mount (9" (22.9 cm) to 11⅞" (30.4 cm) center tilt only)

12" (30.5 cm) to 16" (40.7 cm) (standard or reversed standard controls)

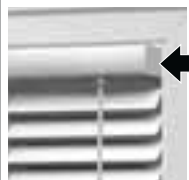
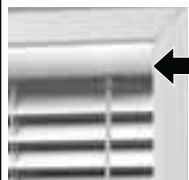

16⅞" (40.8 cm) (same side controls)

<sup>b</sup>Blind width 5½" (14.0 cm) to 22" (55.9 cm): 96" (243.9 cm); blind width 22⅞" (56.1 cm) to 120" (304.8 cm): 144" (365.8 cm)

Depth Requirements for Inside Mount					
<b>Blind Type</b>	<b>Headrail Dimensions inches (cm)</b>		Partially recessed headrail in window casing/ molding		Fully recessed headrail in window casing/ molding
		Minimum Depth Mount inches (cm)	Flush with Casing inches (cm)	Flush Mount with Valance inches (cm)	
½" (1.3 cm) Micro Supreme	1 (2.6) x 1½ (3.9)	¾ (2.0)	1¾ (4.5)	N/A	
1" (2.6 cm) Classics	1 (2.6) x 1½ (3.9)	¾ (2.0)	2½ (6.4)	2½ (6.4)	
1" (2.6 cm) Insignia	1 (2.6) x 1 (2.6)	¾ (2.0)	1⅞ (3.4)	1¾ (4.5)	
1" (2.6 cm) Supreme	1 (2.6) x 1½ (3.9)	¾ (2.0)	1¾ (4.5)	N/A	
2" (5.1 cm) Grandeur	1¾ (4.2) x 2¼ (5.8)	¾ (2.0)	2¾ (6.1)	3⅞ (7.9)	

## Size Considerations

### Cordless Lift Blinds

<b>Styles</b>	<b>Price Group</b>									
		<b>Cordless Lift Blinds</b>				<b>Cordless Lift Multiple Blinds on One Headrail</b>				
		<b>Width</b>		<b>Height</b>		<b>Width</b>			<b>Height</b>	
		<b>Minimum*</b> inches (cm)	<b>Maximum</b> inches (cm)	<b>Minimum</b> inches (cm)	<b>Maximum</b> inches (cm)	<b>Minimum Panel*</b> inches (cm)	<b>Maximum Panel</b> inches (cm)	<b>Maximum Blind</b> inches (cm)	<b>Minimum Blind</b> inches (cm)	<b>Maximum Blind</b> inches (cm)
		1" (2.6 cm) Supreme .006 Gauge	B	18 (45.8)	96 (243.9)	12 (30.5)	84 (213.4) standard 72 (182.9) Hidden Holes	18 (45.8)	60 (152.4)	120 (304.8) (2 on 1) 144 (365.8) (3 on 1) <sup>Δ</sup>
1" (2.6 cm) Supreme .008 Gauge	B									

\*For all inside mount applications— $\frac{3}{8}$ " (1.0 cm) deduction is taken by manufacturer on overall width.

<sup>Δ</sup>The control for the center panel on a three-on-one cordless lift blind will always be on the left.

### Depth Requirements for Inside Mount

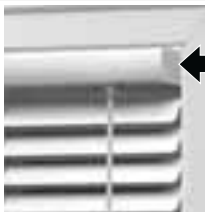
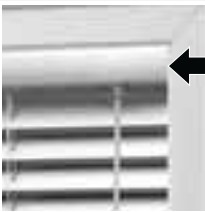
<b>Blind Type</b>	<b>Headrail Dimensions</b> inches (cm)		Partially recessed headrail in window casing/molding Cord lift headrail shown		Fully recessed headrail in window casing/molding Cord lift headrail shown
		<b>Minimum Depth Mount</b> inches (cm)		<b>Flush with Casing</b> inches (cm)	
Supreme	1 (2.6) x 2 $\frac{3}{16}$ (5.6)	$\frac{3}{4}$ (2.0)		2 $\frac{1}{8}$ (5.4)	
Privacy Supreme					

# Options

## Summary

The following is a chart of options for ½" (1.3 cm), 1" (2.6 cm), and 2" (5.1 cm) aluminum blinds. Options that are available vary by blind type. See specific option for availability and detailed descriptions on the following pages.

Features	1" (2.6 cm) Classics	1" (2.6 cm) Insignia™	1" (2.6 cm) Supreme	1" (2.6 cm) Supreme Cordless	½" (1.3 cm) Supreme Micro	2" (5.1 cm) Grandeur™
Bay or Corner Window	•	•	•	•	•	•
Cloth Tapes						•
Control Location						
Standard (Tilt Left/Lift Right)	•	•	•	Tilt left	•	•
Reverse	•	•	•	Tilt right	•	•
Same Side	Over 13¾" (35.0 cm)	Over 11 <sup>15</sup> / <sub>16</sub> " (30.4 cm)	Over 11 <sup>15</sup> / <sub>16</sub> " (30.4 cm)		Over 11 <sup>15</sup> / <sub>16</sub> " (30.4 cm)	Over 16" (40.7 cm)
Cut-outs—to work around any architectural detail	•	•	•		•	•
Double Slats	•		•			
Hidden Holes—for additional privacy, light control, and a cleaner look			•	•		
Inverted Slat—to bring more light into the room	•	•	•	•		•
Limited Tilt	•	•	•		•	
Motorized Tilt (see motorization price list)						•
Multiple Blinds on One Headrail—for large windows	•	•	•	•	•	•
Multi-Colored Striped Blinds—perfect for themed rooms	•		•	•	•	•
Projection Brackets—1¾" (4.5 cm), 2¾" (7.0 cm), 4¾" (12.1 cm) (outside mount only)	•	•	•	•	•	•
Side Mount	Standard	Standard	•*		•*	Standard
Sky Poles—for hard to reach controls, used with ring tilt, ring pull, or cordless handle						
3 to 6½ feet (0.9 m–2.0 m)	•		•	•	•	•
5 to 9½ feet (1.5 m–2.9 m)	•		•	•	•	•
Cord Tilt	•					•
Wand Tilt	Standard	Standard	Standard	Standard	Standard	Standard
Ring Tilt and Ring Pull—6" (15.3 cm)	•		•		•	•
Top-Lock Cordlock	•		•		•	

\*Available up to 60" (152.4 cm) wide.

**NOTE:** Lift cord and tilt cord control lengths will be ⅓ finished blind length.

# Options

## Cord Tilt Controls



### Wand Tilt

- No charge
- Standard



2" (5.1 cm) Grandeur Shown

### Cord Tilt

- No charge
- Optional on 2" (5.1 cm) Grandeur™
- Optional on 1" (2.6 cm) Classics
- Blinds less than 37" (94.0 cm) in height will have a 12" (30.5 cm) cord tilt length standard



### Ring Tilt and Ring Pull

- No charge
- Optional
- Not available on cordless lift
- Optional sky pole available—for surcharge, see options pricing
- Sky pole not available on Insignia™
- Ring pull standard length is 6" (15.3 cm)  
(not available from 6<sup>1</sup>/<sub>16</sub>" (15.4 cm) to 7<sup>15</sup>/<sub>16</sub>" (20.2 cm))

## Cordless Lift



- **For surcharge, see price charts**
- Great for kids' rooms—improved safety
- Choose .006 or .008 gauge 1" (2.6 cm) aluminum slats
- Cordless lift system allows blinds to be raised and lowered easily
- Cordless lift handle keeps the blind clean
- Eliminates unsightly cords
- Patented, sleek headrail design features a lightblocking lip, requires no valance (1<sup>1</sup>/<sub>2</sub>" x 2<sup>3</sup>/<sub>16</sub>" (3.9 cm x 5.6 cm) aluminum)
- Hidden headrail brackets reduce light gaps
- Gear-driven motor provides smooth, quiet operation
- Our painting process allows slats to resist dust, stains, scratches, mold, and mildew
- Color coordinated components provide a finished look
- Choose the Hidden Holes option for more light control and privacy
- Not available with side mount brackets

# Options

## Motorized Tilt Control



- **For surcharges, and additional options, sizing, and accessories, see motorization price list**
- Available on 2" (5.1 cm) aluminum blinds
- Motorization will only tilt slats; raising or lowering the blind is manual with manual lift
- Blinds can be operated from virtually anywhere in the home
- Provides easy operation of hard-to-reach or large blinds
- Efficiently manages energy (heat gain and loss)
- Tilt slats on groups of multiple blinds simultaneously or individually
- Easily integrated with home automation systems
- Low voltage motorization requires no costly electrical hardwiring
- Multiple power source and controls available
- Motor located on the left side within the headrail; manual lift is on the right side
- Not available as multiple blinds on one headrail, or with hold down brackets, cut-outs, or special shapes

# Options

## Hidden Holes

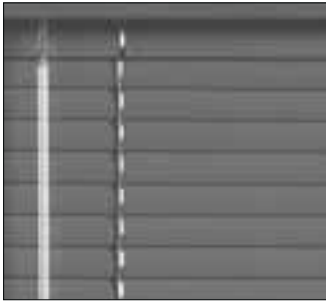

Standard

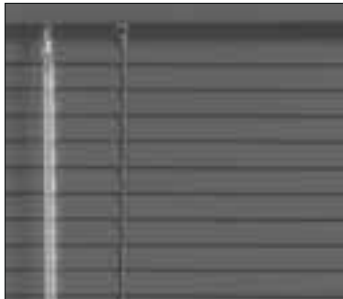

1" (2.6 cm) Hidden Holes

- **For surcharge, see price charts**
- Provides a sleek, elegant look to Graber® 1" (2.6 cm) Supreme and Cordless Supreme Mini Blinds
- Smaller route holes are placed further back on the blinds so they disappear when the blinds are closed, eliminating annoying light gaps
- Sleek, lightblocking headrail is standard and gives the ultimate in privacy and light control

**NOTE:** This option may cause the bottom of the blind to touch the window when raised. Consider ordering projection brackets if this is a concern.

## Inverted Slats



- **For surcharge, see options pricing**
- Inverted slat option brings up to 38% more daylight into the room\*
- Polished Aluminum (741) allows for optimal light
- Reflective surface throws more natural light into the room
- Available on 1" (2.6 cm) and 2" (5.1 cm) styles; not available on ½" (1.3 cm) supreme micro

\*2" (5.1 cm) inverted slat in Polished Aluminum tested 38% more effective in transmitting daylight into the room than standard 2" (5.1 cm) slat in Polished Aluminum.

## Control Length Chart for Cords and Wands

Finished Blind Height inches (cm)	Wand Length inches (cm)	Cord Length
Up to 36 (91.4)	12 (30.5)	Approximately 1/8 of the blind length
36 1/16 (91.6) to 60 (152.4)	20 (50.8)	
60 1/16 (152.6) to 70 (177.8)	30 (76.2)	
70 1/16 (178) to 80 (203.2)	40 (101.6)	
80 1/16 (203.4) to 90 (228.6)	50 (127)	
90 1/16 (228.8) to 100 (254)	60 (152.4)	
100 1/16 (254.2) to 120 (304.8)	72 (182.9)	

**NOTE:** The control lengths listed above may not fit your control needs based on window location or operator. Special length cords or wands may be requested at time of ordering.



# Options

## Multiple Blinds on One Headrail



- For surcharge, see price charts

Two blinds can be installed on a single headrail to provide a practical treatment for larger windows or sliding patio doors.

### Options: Standard Controls

Two-On-One Headrail	Left panel	Tilt/left—lift/left
	Right panel	Tilt/right—lift/right

**NOTE:** For two-on-one headrail, no panel can have a lift located in the center of the blind. Non-standard control positions can be requested.

### Measuring

1. Measure overall width of the area to be covered. If space permits, an overlap of 1½" (3.9 cm) per side is recommended for outside mounts.
2. Measure the width of the area each blind is to cover. Measure and specify the left blind first, continuing to the right. Allow a minimum of ¼" (0.7 cm) between blinds for operating clearance. **NOTE:** Cordless lift has minimum ⅜" (1.0 cm) gap.
3. Total width of all blinds, plus clearance(s), must equal overall width.
4. Measure height as follows:
  - a. For windows, use standard inside or outside measuring procedures.
  - b. For patio doors, measure height within ¾" (2.0 cm) of floor, either from ceiling or a point at least 6½" (16.6 cm) above the door frame. (Check slat count tables if blind is to completely clear the doorway.)

### Ordering

1. Indicate blinds that are to be mounted on one headrail.
2. Specify total width of headrail for inside mount that is the total window opening.
3. Indicate each panel size, specify left blind first, continuing to the right.
4. Specify gaps.
5. Specify control positions, if other than standard.
6. Add applicable surcharge.

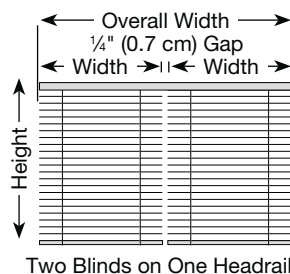

**NOTE:** Cordless lift multiple blinds have a ⅜" (1.0 cm) gap between blinds.

# Options

## Multi-Colored Striped Blinds

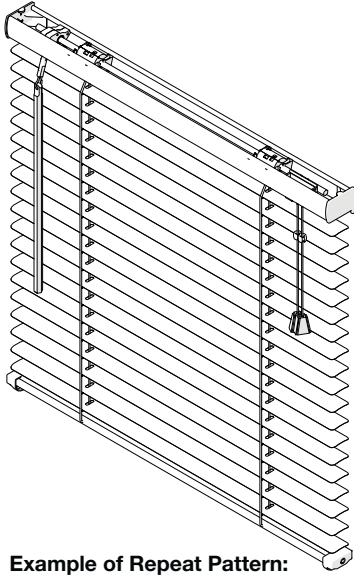

### Example of Repeat Pattern:

- 3 Slats—085 Real Red
- 3 Slats—205 White Satin
- 3 Slats—089 True Blue
- 3 Slats—085 Real Red
- 3 Slats—205 White Satin
- 1 Slats—089 True Blue

- For surcharge, see options pricing
- Multi-colored blinds are the combination of two or more colors on one blind
- Headrail, bottomrail, and installation brackets will match the color of the top slat
- Maximum of five colors can be used in a repeated or exact striped design
- Ladder supports and lifts will be color coordinated to the headrail color
- Contact customer service to change color coordination
- Not available on 1" (2.6 cm) Insignia™

### Specifying Colors

1. Make a diagram of the blind, showing height.
2. From the slat count table, determine the total number of slats.
3. Bottomrail will match the color of the last slat if color pattern consists of at least four color slats in each color group. Otherwise, it will be the color of the headrail.

### Ordering

1. Please specify if an exact or repeat pattern.
  - Repeat: color order repeats in a pattern
  - Exact: color order is specifically defined; not in a repeated pattern
2. May specify headrail, bottomrail, ladder, and cord colors.

### Example of Repeat Pattern:

Multi-color diagram (sample of 1" (2.6 cm) supreme aluminum)  
 Height = 14" (35.6 cm)  
 Total slats = 16

## Cloth Tapes and Colors



- For surcharge, see price charts
- Add a decorative touch with cloth tapes
- Only available on 2" (5.1 cm) Grandeur™ aluminum blinds
- Colors available:

1" (2.6 cm) Solid Tapes		1½" (3.9 cm) Solid Tapes	
Beige	1011	Beige	2011
Black	1033	Black	2033
Cocoa	1297	Chocolate	2353
Duck White	1136	Cocoa	2297
Toffee	1296	Dark Grey	2857
		Duck White	2136
		Light Beige	2137
		Light Grey	2861
		Maroon	2360
		Moss	2500
		Navy	2369
		Pecan	2403
		Taupe	2659
		Toffee	2296
		Wheat	2710
		White	2005
		White Smoke	2617

# Options

## Cut-out Blinds

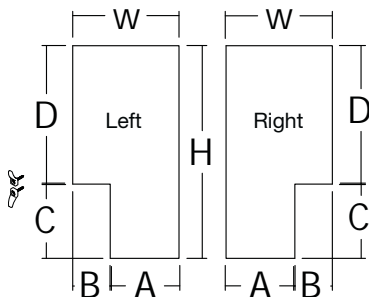
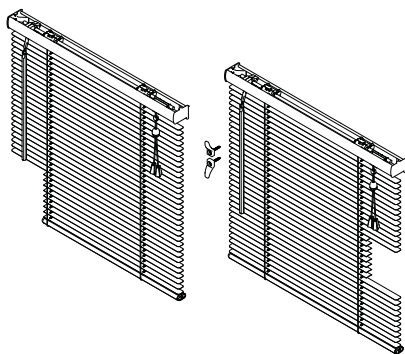

- For surcharge, see options pricing
- Cut-outs are not available on cordless lift blinds

### Bottom Corner and Side (Door Knob):

1" (2.6 cm) and ½" (1.3 cm) aluminum: maximum cut-out is blind width minus 10" (25.4 cm). A cut-out over 10" (25.4 cm) requires an intermediate rail.

2" (5.1 cm) vinyl and aluminum: maximum cut-out is 1" (2.6 cm) before the route hole.

(A) minimum is 5" (12.7 cm).

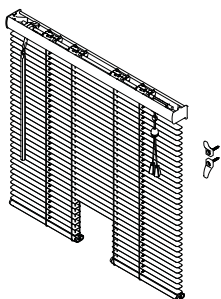

### Bottom Center:

(A) and (C) minimum is 5" (12.7 cm).

If (B) is greater than 10" (25.4 cm), there will be an intermediate rail.

**Not available on 2" (5.1 cm) blinds.**

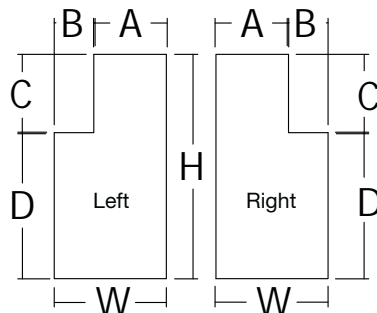
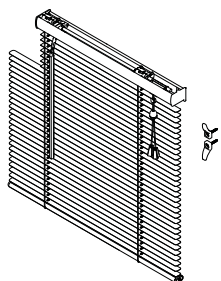

### Top Corner:

Maximum cut-out width is limited to ¼ of total blind width.

(A) minimum is 14" (35.6 cm).

(B) is limited to ¼ total blind width.

If (B) is greater than 8" (20.4 cm), there will be an intermediate rail.

**Not available on 2" (5.1 cm) blinds.**

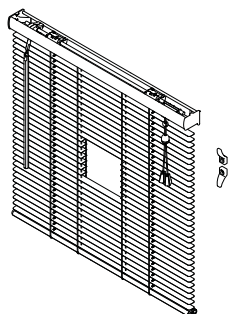

### Interior:

Both (A) and (C) minimum width is 5" (12.7 cm).

Maximum width for (B) is blind width minus 20" (50.8 cm).

**Not available on 2" (5.1 cm) blinds.**

**NOTE:** Oversized cut-out could require an intermediate support rail. Slats will not lift below intermediate rail.

# Options

## Bay and Corner Windows

- Made as individual blinds to fit in bay or corner windows
- Each section will have its own control; we recommend opposite corners
- Indicate each blind with bypass or butt; bypass is the blind mounted into the corner; butt is the blind butted up to the other blind

- Manufacturer will take appropriate deductions for proper fit
- Cornices are not available

**NOTE:** If you do not want vendor to take deductions, DO NOT order as bay or corner.

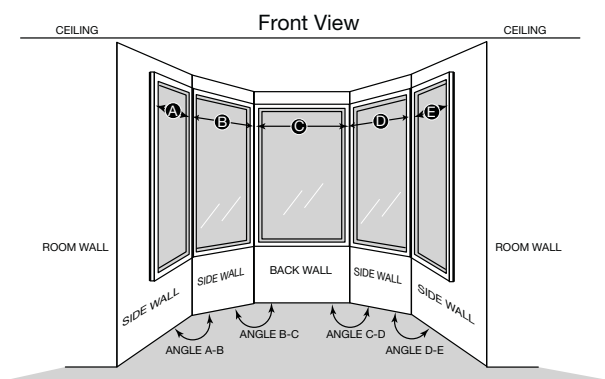
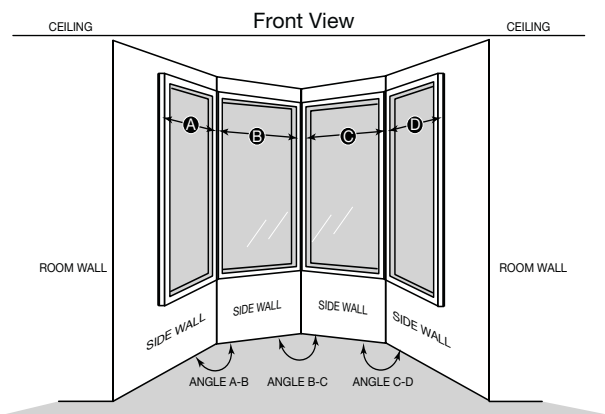
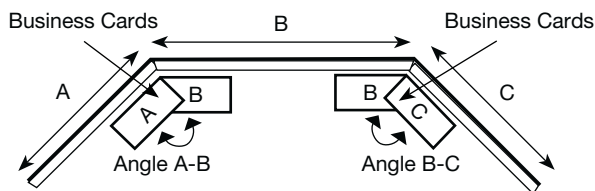
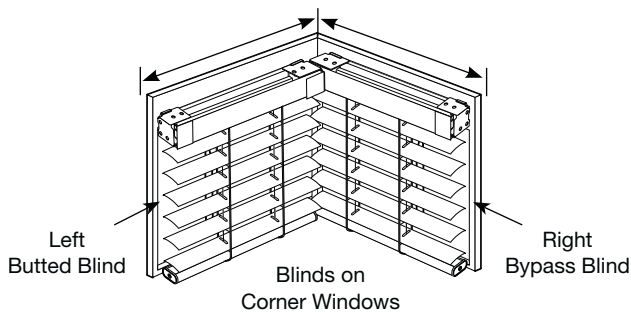

### Measuring Information

#### Corner Window

Measure:  
Width of each window from corner to the point you would like to cover.

#### Three-Sided Bay Window

Measure:  
A and C: Width of side windows from the corners to the point you would like the blind to cover.  
B: Width of the center window from corner to corner.  
Angle A-B: Angle between windows (A) and (B).  
Angle B-C: Angle between windows (B) and (C).

#### Four-Sided Bay Window

Measure:  
A and D: Width of side windows from the corners to the point you would like the blind to cover.  
B and C: Width of each window from corner to corner.  
Angle A-B: Angle between windows (A) and (B).  
Angle B-C: Angle between windows (B) and (C).  
Angle C-D: Angle between windows (C) and (D).

#### Five-Sided Bay Window

Measure:  
A and E: Width of side windows from the corners to the point you would like the blind to cover.  
B, C and D: Width of each center window from corner to corner.  
Angle A-B: Angle between windows (A) and (B).  
Angle B-C: Angle between windows (B) and (C).  
Angle C-D: Angle between windows (C) and (D).  
Angle D-E: Angle between windows (D) and (E).

**NOTE:** Measure bay angle using protractor or angle finder, or use two business cards in bay corner as illustrated above, trace angle onto paper, and fax to customer service.

# Options

## Specialty Shapes: Skylights Dual Headrail or Incline Wire Blinds

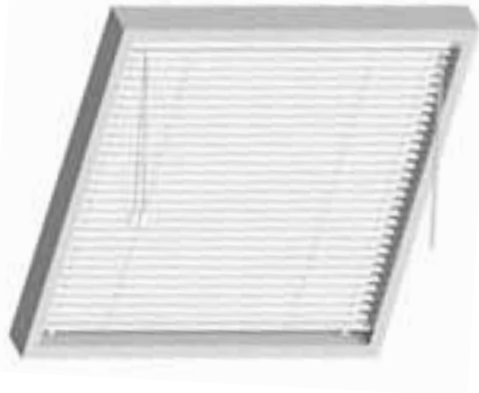

### Incline Wire Features

- For surcharge, see price charts
- Degree from vertical cannot exceed 45 degrees
- Available in all specialty shapes except arches and circles
- Choose .006 or .008 gauge 1" (2.6 cm) aluminum slat
- 1" x 1½" (2.6 cm x 3.9 cm) steel headrail, box design
- Wand tilt left (standard) or right
- Lift cord right (standard) or left
- Color coordinated components provide a finished look
- Sky poles for easy tilting available upon request
- Blinds inclined over 30 degrees from vertical will have marginal tilt operation
- Blinds inclined over 40 degrees from vertical will lower marginally
- Available in cord tilt (exceptions: arch and circle)

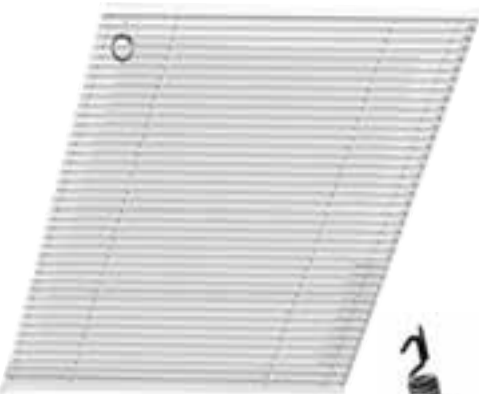

### Dual Headrail Features

- For surcharge, see price charts
- For windows at more than a 45 degree angle
- Blinds are tilt only
- Choose .006 or .008 gauge 1" (2.6 cm) aluminum slat
- 1" x 1½" (2.6 cm x 3.9 cm) steel headrail, box design
- Ring tilt left (standard) or right
- Color coordinated components provide a finished look
- Sky poles for easy tilting available upon request
- When hanging on flat ceiling surface, the tilt function is not fully functional



Sky Pole

	Incline Wire inches (cm)		Dual Headrail inches (cm)	
Minimum Width	12 (30.5) exact		12 (30.5)	
Maximum Width	122 (309.9)		142 (360.7)	
Minimum Height	10 (25.4)		10 (25.4)	
	Blind Width inches (cm)	Max Height inches (cm)	Blind Width inches (cm)	Max Height inches (cm)
Maximum Height	12 (30.5)–32 (81.3)	126 (320.1)	12 (30.5)–23 (58.5)	126 (320.1)
	32½ (81.6)–57 (144.8)	108 (274.4)	23½ (58.8)–32 (81.3)	102 (259.1)
	57½ (145.1)–92 (233.7)	102 (259.1)	32½ (81.6)–72 (182.9)	90 (228.6)
	92½ (233.9)–122 (309.9)	90 (228.6)	72½ (183.2)–142 (360.7)	80 (203.2)

# Options

## Specialty Shapes: Skylights Dual Headrail or Incline Wire Blinds

### Measuring Information

#### Inside Mount

- A. Width**—Measure the exact inside width of the window casing from one inside edge to the other in three different places. Record the narrowest measurement.
- B. Height**—Measure the exact height in three different places from the top edge of the opening to the top of the sill. Record the longest measurement.

Do not deduct for headrail clearance gaps. Manufacturer will make all allowances for both width and height. Headrail, tension rail, and slats will be manufactured  $\frac{1}{2}$ " (1.3 cm) less than the dimension given as width. Proper deductions will be made for blind height.

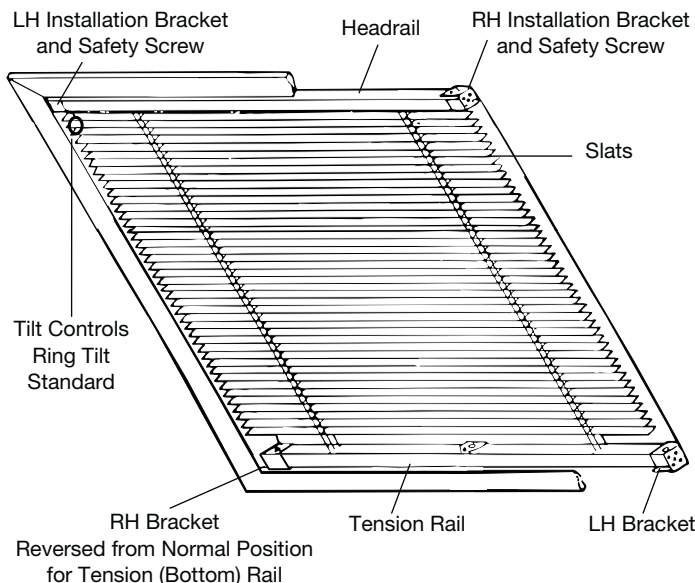
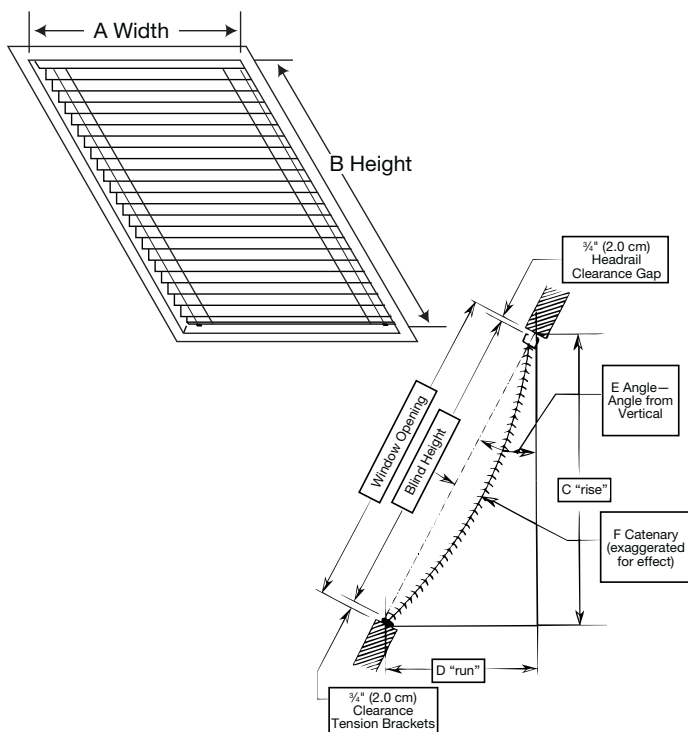

#### Outside Mount

Measure width and height dimensions, and specify as “blind size, cut exact.” The manufacturer will not make any allowances for width or height. Headrail, tension rail, and slats will equal dimensions given as width. Blind height will refer to the distance from the top of the upper bracket to the lower bracket of the installed blind and will equal dimension given as height. Do not deduct for headrail and tension rail clearance gaps.

#### Incline Wire Skylight

Ideal for skylights at up to a 45 degree angle.

**NOTE:** Blinds can lift and tilt.

Used in windows installed vertically to 45 degrees from vertical (maximum).

- A. Width**—Measure the exact inside width of the window casing from one inside edge to the other in three different places. Record the narrowest measurement.
- B. Height**—Measure the exact height in three different places from the top edge of the opening to the top of the sill. Record the longest measurement.
- C. Rise**—The vertical measurement from the top of a window to the RUN to form a 90 degree angle.
- D. Run**—The horizontal measurement from the bottom of a window to the RISE to form a 90 degree angle.
- E. Angle**—The degree the window is slanted perpendicular (at a right angle) to the floor.
- F. Catenary**—The degree a blind may possibly bow. No measurement needed.

Must give measurements for “A” and “B.” “C” and “D” are used to calculate the angle (must be less than 45 degrees).

#### Dual Headrail Skylight

Ideal for skylights at more than a 45 degree angle.

**NOTE:** Blind is tilt only, no lift.

## Options

### Specialty Shapes: Arches

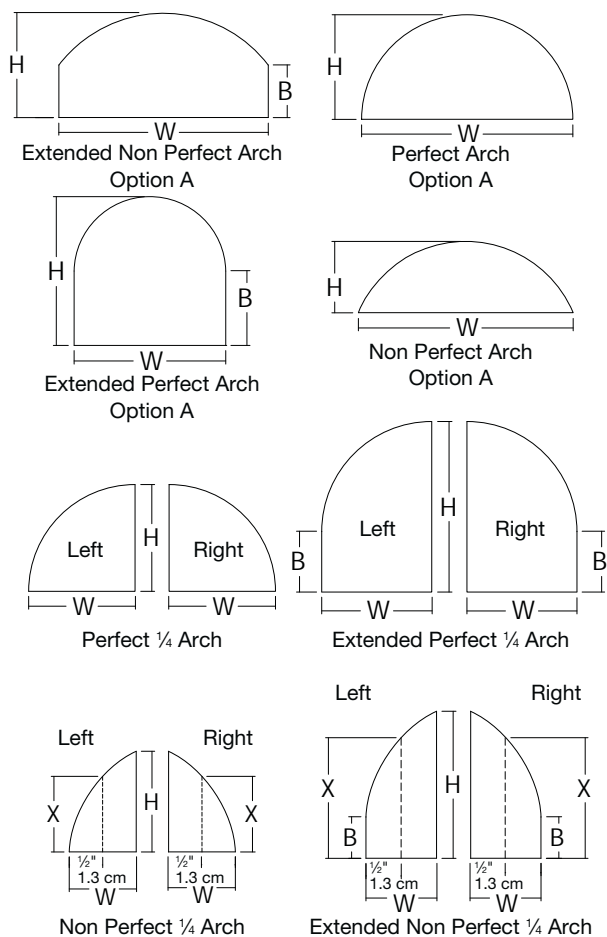

- For surcharge, see price charts
- Choose .006 or .008 gauge 1" (2.6 cm) aluminum slat
- Use 1" x 1" (2.6 cm x 2.6 cm) aluminum headrail
- Valance not available
- A template is required for all arches except perfect arches
- Limitations may apply within each blind type; fax a drawing to customer service to determine availability
- May require four to six weeks lead time to manufacture

Size Considerations	Arches inches (cm)	Quarter Arch inches (cm)
Minimum Width	10 (25.4)	12 $\frac{3}{4}$ (32.4)
Maximum Width	Base 142 (360.7)	142 (360.7)
Minimum Height	5 (12.7)	6 (15.3)
Maximum Height	126 (320.1)	126 (320.1)

#### Controls

- Arches: standard, reverse, or same side
- Quarter arch: low side
- Full tilt: lift depends on shape
- Cord tilt: not available
- No lift: perfect arch, non perfect arch, perfect 1/4 arch, extended perfect 1/4 arch, non perfect 1/4 arch, extended non perfect 1/4 arch

#### Ordering Information

- Full arch: to order, choose specialty option A
- Quarter arches: choose specialty option F for left quarter arch and option G for right quarter arch

Only available on 1" (2.6 cm) classics blinds.

### Specialty Shapes: Circles

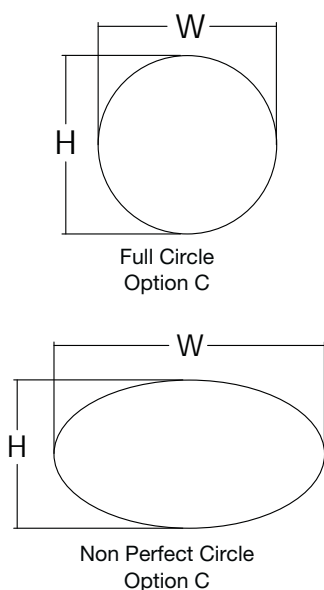

- For surcharge, see price charts
- Choose .006 or .008 gauge 1" (2.6 cm) aluminum slat
- An illustration can be resized
- Uses 1" x 1" (2.6 cm x 2.5 cm) aluminum headrail
- Valance not available
- A template is required for all non perfect circles (see instructions for making a template)
- Limitations may apply within each blind type; fax a drawing to customer service to determine availability
- May require up to four to six weeks lead time to manufacture

Size Considerations	
Minimum Width	12" (30.5 cm) diameter
Maximum Width/Height	72" (182.9 cm)

#### Controls

- Controls: left or right
- Full tilt: no lift
- Cord tilt: not available

# Options

## Specialty Shapes: Side Cut, Angle Top, Angle Bottom

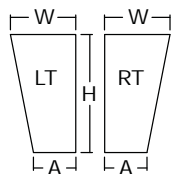

Side Cut  
Option V

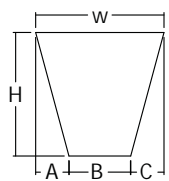

Double Side Cut  
Option V

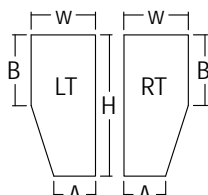

Extended Side Cut  
Option V

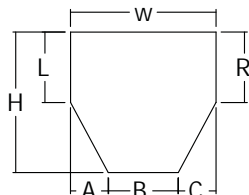

Extended Double Side Cut  
Option V

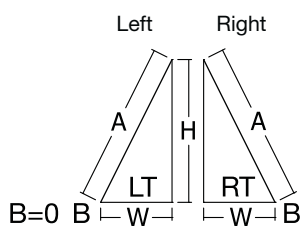

Angle Top  
Option P

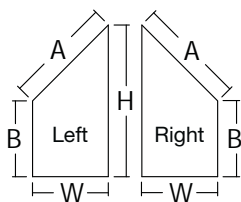

Extended Angle Top  
Option P

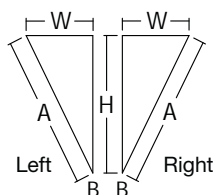

Angle Bottom  
Option B

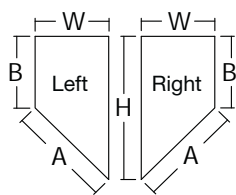

Extended Angle Bottom  
Option B

- For surcharge, see price charts
- Choose .006 or .008 gauge 1" (2.6 cm) aluminum slat
- An illustration can be reversed or resized
- Use 1" x 1½" (2.6 cm x 3.9 cm) steel headrail
- Valance not available
- Limitations may apply within each blind type; fax a drawing to customer service to determine availability
- May require up to four to six weeks lead time to manufacture
- To order, fax a signed drawing with all dimensions to customer service
- Available as incline wire for skylights

Size Considerations	Side Cuts inches (cm)	Angle Top and Bottom inches (cm)
Minimum Bottomrail	4½ (11.5) exact	12 (30.5) exact
Maximum Width	142 (360.7)	142 (360.7)
Minimum Height	6 (15.3)	12 (30.5)
Maximum Height	126 (320.1)	126 (320.1)
Minimum Headrail	7½ (19.1)	12 (30.5)

### Controls

- Side cuts: standard, reverse, or same side (straight side only)
- Angle bottoms: standard, reverse, or same side (dependent on shape)
- Angle and extended angle tops and bottoms: cordlock must be low side
- Full tilt: lift depends on shape
- Cord tilt: available (not available with incline wire)
- Angle bottoms: 60° maximum angle degree; for greater than 60°, order side cut, bottom point will have light gap

### Ordering Information

Choose specialty option indicated below illustration.



# Options

## Specialty Shapes: Octagons, Triangles, Other Shapes

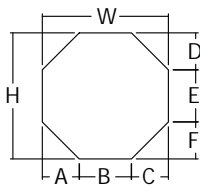

Octagon  
Option U

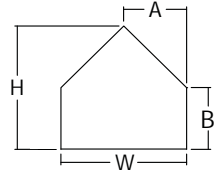

Extended Triangle  
Option T

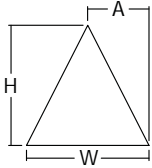

Triangle  
Option I

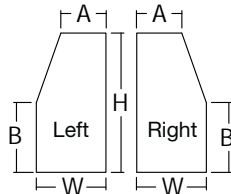

Extended  
Inverted Side Cut  
Option I

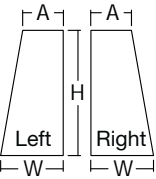

Inverted Side Cut  
Option I

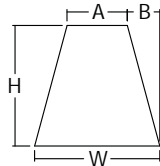

Inverted Double Side Cut  
Option I

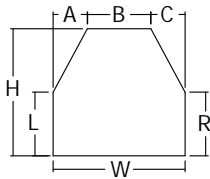

Extended Inverted  
Double Side Cut  
Option I

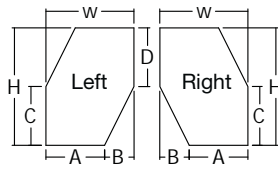

Extended Offset Cut  
Option I

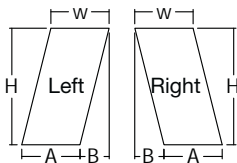

Offset Cut  
Option I

- **For surcharge, see price charts**

- Choose .006 or .008 gauge 1" (2.6 cm) aluminum slat
- An illustration can be inverted or reversed or resized
- Headrail is split on many of these shapes
- Use 1" x 1½" (2.6 cm x 3.8 cm) steel headrail
- Valance not available
- Limitations may apply within each blind type; fax a drawing to customer service to determine availability
- May require up to four to six weeks lead time to manufacture
- To order, fax a signed drawing with all dimensions to customer service
- Available as incline wire for skylights

Size Considerations	Octagon inches (cm)	Triangle inches (cm)	Other Shapes inches (cm)
Minimum Width	7½ (19.1) exact headrail	12 (30.5)	7½ (19.1) exact headrail
Maximum Width	142 (360.7) or 192 (487.7) maximum total combined headrail segments		
Minimum Height	18½ (46.1)	12 (30.5)	12 (30.5)
Maximum Height	126 (320.1)	126 (320.1)	126 (320.1)

### Controls

- Controls: standard, reverse, or same side (straight side only)
- Full tilt left or right: lift depends on shape
- Limited tilt: available
- Cord tilt: available (not available with incline wire)
- No lift: triangle

### Ordering Information

Choose specialty option indicated below illustration.

## Options

### Making a Template for Specialty Shape Windows

1. Tape butcher paper, kraft, or construction paper over the window opening allowing plenty of overlap.
2. Being careful not to press against the template paper while tracing, draw an exact outline of the window opening. Pressing on the template paper may distort the paper and cause the wrong size to be made.
3. Remove the paper from the window opening. If the blind is an outside mount, add the desired amount of overlap to the window outline and draw a second outline around it to match the shape of the finished blind. **Be sure to erase the inside line.**
4. Mark the dimensions on the template. Check that the template dimensions match your measurements of the actual window opening.  
**NOTE:** Make sure the template is of the window opening, not the glass only measurement.
5. **Cut the shape from the paper.**
6. **PLACE THE TEMPLATE BACK INTO THE WINDOW OPENING TO CHECK FOR PROPER FIT COMPLETELY AROUND.**
7. Indicate on the template
  - “Room side” and “top” on the template
  - Purchase order number
  - Customer’s name
  - Your store name and account number
8. Roll up template and place in a mailing tube.  
**DO NOT FOLD TEMPLATE.**

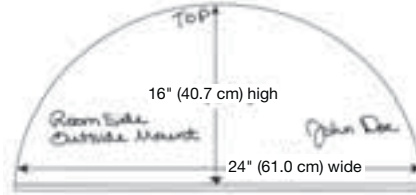

**NOTE:** This is just a sample for illustration purposes only—other information may be needed for your order.

**Mail to:** Springs Window Fashions LLC  
33 West Third Street  
Suite 400  
Williamsport, PA 17701  
ATTN: Specialty Dept.

**NOTE:** When mailing, make sure to get a tracking number and note your return address on the mailing tube.

#### ACCEPTABLE MATERIALS FOR MAKING TEMPLATES:

Kraft paper  
Butcher paper  
Construction paper

#### WE WILL NOT ACCEPT TEMPLATES MADE FROM THE FOLLOWING MATERIALS:

Newspaper                      Plastic  
Wax paper                      Fabric  
Tissue paper                    Roofing paper  
Existing arch blinds          Wrapping paper

**NOTE:** If the material used to make a template stretches, tears easily, will not lay flat, or will mark the fabric—IT WILL NOT BE USED.

### Using the Template Service

To use the “template service”, simply:

1. Select template service when entering your order online.
2. Use the template worksheet to determine what measurements you need to supply for each shape.
3. Enter the lettered measurements using line item comments. The comments have been preprogrammed to all of the measurements you need to enter for your special shape.

See note at bottom of price grids if template service fees apply.

# General Information

## Aluminum Color Assortment

Color Name	Color Number	1" (2.6 cm) Insignia™	1" (2.6 cm) Classics	1" (2.6 cm) Cordless Lift	1" (2.6 cm) Supreme	½" (1.3 cm) Micro Supreme	2" (5.1 cm) Grandeur™
Alabaster	112	•	•	•	•	•	•
Alabaster Pearl	326		•	•	•	•	•
Almond	724		•		•		•
Almost White Gloss	065	•	•	•	•	•	•
Aluminum	034	•	•	•	•	•	
Ash Metallic	126		•		•		•
Beige	011	•	•	•	•	•	
Beige Pearl	328		•	•	•		
Birch White	375		•		•		
Black Satin	233	•	•	•	•	•	•
Brushed Aluminum	121	•	•	•	•	•	•
Buff	624	•	•		•		
Burgundy	653	•	•	•	•		
Cameo	607	•	•	•	•		
Canary Yellow	009			•	•		
Char Brown	062	•	•	•	•	•	•
Coconut	630	•	•	•	•		
Creamy Beige	670	•	•		•	•	•
Crystal White	629	•	•	•	•	•	
Desert Sand	625	•	•	•	•		
Fawn	031	•	•	•	•	•	
Fawn Pearl	327		•	•	•	•	
Flax	541	•	•	•	•	•	
Forest Shadow	087	•	•		•		
Granite	044	•	•		•		
Gray Dawn	405		•		•		
Gray Haze	983	•	•		•	•	•
Greige	122	•	•		•	•	•
Hunter Green	154		•	•	•		•
Ice	778	•	•		•		
Lamplight	904	•	•	•	•		•
Lavender Lace	024			•	•		
Little Boy Blue	090			•	•		
Magnet	648		•		•		
Matte White	042	•	•		•	•	
Mercury	771		•		•		
Midnight Blue	057		•		•		
Milk Chocolate	060	•	•	•	•	•	
Navajo White	376		•		•		
Parchment	535	•	•		•	•	
Pitch Black	033	•	•		•	•	
Polished Aluminum	741	•	•	•	•		•
Princess Pink	023			•	•		
Raw Umber	006	•	•		•	•	•
Real Red	085	•	•	•	•		
Rock Gray	399		•		•		
Silver	737	•	•		•		
Skyline	680		•		•		
Smokey Gray	026	•	•		•	•	
Snowcap White	386	•	•	•	•		•
Stucco	963	•	•		•		•
Tender Taupe	103		•		•		
True Blue	089	•	•	•	•		
True White	544	•	•	•	•	•	•
U.N. Gray	095	•	•		•		
Vanilla	100	•	•	•	•	•	
White Gloss	005	•	•		•	•	•
White Pearl	637		•	•	•		
White Satin	205	•	•		•	•	•

# General Information

## Color Coordination Charts: ½" (1.3 cm) and 1" (2.6 cm) Aluminum

Color Number	Color Name	Rail and Brackets	Ladders and Cord	Tassels and Endcaps
005	White Gloss	005	005	005
006	Raw Umber	006	033	006
009	Canary Yellow	009	009	009
011	Beige	011	103	011
023	Princess Pink	023	023	023
024	Lavender Lace	024	024	024
026	Smokey Gray	026	026	026
031	Fawn	031	031	031
033	Pitch Black	033	033	033
034	Aluminum	034	026	026
042	Matte White	042	112	112
044	Granite	044	814	825
057	Midnight Blue	057	008	008
060	Milk Chocolate	060	060	060
062	Char Brown	062	062	062
065	Almost White Gloss	065	112	112
085	Real Red	085	835	025
087	Forest Shadow	087	087	087
089	True Blue	089	089	089
090	Little Boy Blue	090	090	090
095	U.N. Gray	095	033	591
100	Vanilla	100	112	100
103	Tender Taupe	103	103	103
112	Alabaster	112	112	112
121	Brushed Aluminum	034	026	026
122	Greige	122	026	122
126	Ash Metallic	126	126	126
154	Hunter Green	154	154	117
205	White Satin	205	005	005
233	Black Satin	233	033	033
326	Alabaster Pearl	112	112	112
327	Fawn Pearl	031	031	031
328	Beige Pearl	011	103	011
375	Birch White	375	005	005
376	Navajo White	376	112	112
386	Snowcap White	386	005	005
399	Rock Gray	399	026	026
405	Gray Dawn	405	026	026
535	Parchment	535	004	004
541	Flax	541	112	112
544	True White	544	005	005
607	Cameo	670	031	356
624	Buff	624	031	031
625	Desert Sand	625	029	029
629	Crystal White	629	005	005
630	Coconut	630	112	112
637	White Pearl	205	005	005
648	Magnet	648	648	648
653	Burgundy	653	106	106
670	Creamy Beige	670	031	356
680	Skyline	680	591	591
724	Almond	724	004	004
737	Silver	737	026	114
741	Polished Aluminum	034	026	026
771	Mercury	771	026	026
778	Ice	778	778	778
904	Lamplight	904	031	031
963	Stucco	963	026	963
983	Gray Haze	983	026	026

## General Information

### Color Coordination Charts: 2" (5.1 cm) Grandeur™ Aluminum

Color Number	Color Name	Rail and Brackets	Ladders and Cord	Tilts	Tassels, Bottom Rail End Caps
005	White Gloss	205	005	White	005
006	Raw Umber	033	033	Black	006
062	Char Brown	062	062	Black	062
065	Almost White Gloss	112	112	White	112
112	Alabaster	112	112	White	112
121	Brushed Aluminum	034	026	Black	026
122	Greige	122	026	Black	122
126	Ash Metallic	126	126	Black	126
154	Hunter Green	154	154	Black	117
205	White Satin	205	005	White	005
233	Black Satin	233	033	Black	033
326	Alabaster Pearl	112	112	White	112
386	Snowcap White	386	005	White	005
544	True White	205	005	White	005
670	Creamy Beige	670	031	White	356
724	Almond	724	004	White	004
741	Polished Aluminum	034	026	Black	026
904	Lamplight	904	031	White	031
963	Stucco	963	026	White	963
983	Gray Haze	983	026	White	026

### Ladder Color Coordination: Dual Headrail

The Graber® Skylight Blind uses a specially constructed ladder designed for the interlacing of slats. The five ladder colors offered will coordinate with many slat colors.

**NOTE:** You may request a different ladder color.

Interlacing Ladder Color	Slat Color Examples					
	Color Name	Color Number	Color Name	Color Number	Color Name	Color Number
Char Brown #062	Char Brown	062	Milk Chocolate	060	Tender Taupe	103
	Granite	044	Raw Umber	006		
Smokey Gray #026	Aluminum	034	Greige	122	Skyline	680
	Black Satin	233	Pitch Black	033	Smokey Gray	026
	Brushed Aluminum	121	Polished Aluminum	741	Stucco	963
	Gray Dawn	405	Rock Gray	399	UN Gray	095
	Gray Haze	983	Silver	737		
Fawn #031	Buff	624	Desert Sand	625	Lamplight	904
	Cameo	607	Fawn	031		
	Creamy Beige	670	Fawn Pearl	327		
White Gloss #005	Burgundy	653	Magnet	648	True Blue	089
	Coconut	630	Mercury	771	True White	544
	Crystal White	629	Midnight Blue	057	White Gloss	005
	Forest Shadow	087	Navajo White	376	White Satin	205
	Hunter Green	154	Real Red	085	White Pearl	637
	Ice	778	Snowcap White	386		
Alabaster #112	Alabaster	112	Ash Metallic	126	Flax	541
	Alabaster Pearl	326	Beige	011	Matte White	042
	Almond	724	Beige Pearl	328	Parchment	535
	Almost White Gloss	065	Birch White	375	Vanilla	100

# General Information

## Stack Height Chart

Finished Blind Height inches (cm)	Cordless Supreme inches (cm)	Cordless Supreme Hidden Holes inches (cm)	Classics and Supreme inches (cm)	Supreme Hidden Holes inches (cm)	Insignia™ inches (cm)	Supreme ½" (1.3 cm) Micro inches (cm)	2" (5.1 cm) Grandeur™ inches (cm)
10 (25.4)			2 (5.1)	2 (5.1)	1 <sup>3</sup> / <sub>16</sub> (4.7)	2 <sup>1</sup> / <sub>16</sub> (5.3)	3 <sup>3</sup> / <sub>8</sub> (8.6)
15 (38.1)	2 <sup>3</sup> / <sub>16</sub> (5.6)	2 <sup>1</sup> / <sub>8</sub> (5.4)	2 <sup>1</sup> / <sub>16</sub> (5.3)	2 <sup>1</sup> / <sub>8</sub> (5.4)	1 <sup>1</sup> / <sub>8</sub> (4.8)	2 <sup>1</sup> / <sub>4</sub> (5.8)	3 <sup>1</sup> / <sub>2</sub> (8.9)
20 (50.8)	2 <sup>1</sup> / <sub>4</sub> (5.8)	2 <sup>1</sup> / <sub>4</sub> (5.8)	2 <sup>3</sup> / <sub>16</sub> (5.6)	2 <sup>1</sup> / <sub>4</sub> (5.8)	2 (5.1)	2 <sup>7</sup> / <sub>16</sub> (6.2)	3 <sup>5</sup> / <sub>8</sub> (9.3)
25 (63.5)	2 <sup>3</sup> / <sub>8</sub> (6.1)	2 <sup>3</sup> / <sub>8</sub> (6.1)	2 <sup>1</sup> / <sub>4</sub> (5.8)	2 <sup>3</sup> / <sub>8</sub> (6.1)	2 <sup>1</sup> / <sub>8</sub> (5.4)	2 <sup>11</sup> / <sub>16</sub> (6.9)	3 <sup>1</sup> / <sub>16</sub> (9.4)
30 (76.2)	2 <sup>7</sup> / <sub>16</sub> (6.2)	2 <sup>1</sup> / <sub>2</sub> (6.4)	2 <sup>3</sup> / <sub>8</sub> (6.1)	2 <sup>1</sup> / <sub>2</sub> (6.4)	2 <sup>3</sup> / <sub>16</sub> (5.6)	2 <sup>1</sup> / <sub>8</sub> (7.4)	3 <sup>3</sup> / <sub>16</sub> (9.7)
35 (88.9)	2 <sup>9</sup> / <sub>16</sub> (6.6)	2 <sup>9</sup> / <sub>16</sub> (6.6)	2 <sup>1</sup> / <sub>2</sub> (6.4)	2 <sup>11</sup> / <sub>16</sub> (6.9)	2 <sup>3</sup> / <sub>8</sub> (5.9)	3 <sup>1</sup> / <sub>8</sub> (8.0)	3 <sup>15</sup> / <sub>16</sub> (10.1)
40 (101.6)	2 <sup>11</sup> / <sub>16</sub> (6.9)	2 <sup>7</sup> / <sub>16</sub> (6.2)	2 <sup>5</sup> / <sub>8</sub> (6.7)	2 <sup>13</sup> / <sub>16</sub> (7.2)	2 <sup>3</sup> / <sub>8</sub> (6.1)	3 <sup>1</sup> / <sub>4</sub> (8.3)	4 <sup>1</sup> / <sub>16</sub> (10.4)
45 (114.3)	2 <sup>3</sup> / <sub>4</sub> (7.0)	2 <sup>3</sup> / <sub>4</sub> (7.0)	2 <sup>3</sup> / <sub>4</sub> (7.0)	2 <sup>15</sup> / <sub>16</sub> (7.5)	2 <sup>1</sup> / <sub>2</sub> (6.4)	3 <sup>7</sup> / <sub>16</sub> (8.8)	4 <sup>3</sup> / <sub>16</sub> (10.7)
50 (127.0)	2 <sup>7</sup> / <sub>8</sub> (7.4)	2 <sup>7</sup> / <sub>8</sub> (7.4)	2 <sup>7</sup> / <sub>8</sub> (7.4)	3 <sup>1</sup> / <sub>8</sub> (7.8)	2 <sup>5</sup> / <sub>8</sub> (6.7)	3 <sup>11</sup> / <sub>16</sub> (9.4)	4 <sup>5</sup> / <sub>16</sub> (11.0)
55 (139.7)	3 (7.7)	3 (7.7)	3 (7.7)	3 <sup>1</sup> / <sub>4</sub> (8.3)	2 <sup>11</sup> / <sub>16</sub> (6.9)	3 <sup>3</sup> / <sub>8</sub> (9.9)	4 <sup>3</sup> / <sub>8</sub> (11.2)
60 (152.4)	3 <sup>1</sup> / <sub>16</sub> (7.7)	3 <sup>1</sup> / <sub>16</sub> (7.8)	3 <sup>1</sup> / <sub>8</sub> (8.0)	3 <sup>3</sup> / <sub>8</sub> (8.6)	2 <sup>13</sup> / <sub>16</sub> (7.2)	4 <sup>1</sup> / <sub>16</sub> (10.4)	4 <sup>1</sup> / <sub>2</sub> (11.5)
65 (165.1)	3 <sup>3</sup> / <sub>16</sub> (8.1)	3 <sup>3</sup> / <sub>16</sub> (8.1)	3 <sup>1</sup> / <sub>4</sub> (8.3)	3 <sup>1</sup> / <sub>2</sub> (8.9)	2 <sup>7</sup> / <sub>8</sub> (7.4)	4 <sup>7</sup> / <sub>16</sub> (11.3)	4 <sup>5</sup> / <sub>8</sub> (11.8)
70 (177.8)	3 <sup>1</sup> / <sub>4</sub> (8.3)	3 <sup>1</sup> / <sub>4</sub> (8.3)	3 <sup>3</sup> / <sub>8</sub> (8.6)	3 <sup>11</sup> / <sub>16</sub> (9.4)	3 (7.7)	4 <sup>1</sup> / <sub>2</sub> (11.5)	4 <sup>3</sup> / <sub>4</sub> (12.1)
75 (190.5)	3 <sup>3</sup> / <sub>8</sub> (8.6)		3 <sup>7</sup> / <sub>16</sub> (8.8)	3 <sup>13</sup> / <sub>16</sub> (9.7)	3 <sup>1</sup> / <sub>8</sub> (8.0)	4 <sup>11</sup> / <sub>16</sub> (12.0)	4 <sup>7</sup> / <sub>8</sub> (12.4)
80 (203.2)	3 <sup>1</sup> / <sub>2</sub> (8.9)		3 <sup>9</sup> / <sub>16</sub> (9.1)	3 <sup>15</sup> / <sub>16</sub> (10.1)	3 <sup>3</sup> / <sub>16</sub> (8.1)	4 <sup>3</sup> / <sub>8</sub> (12.4)	5 (12.7)
85 (215.9)			3 <sup>11</sup> / <sub>16</sub> (9.4)	4 <sup>1</sup> / <sub>16</sub> (10.4)	3 <sup>5</sup> / <sub>16</sub> (8.5)	5 <sup>1</sup> / <sub>8</sub> (13.1)	5 <sup>1</sup> / <sub>8</sub> (13.1)
90 (228.6)			3 <sup>13</sup> / <sub>16</sub> (9.7)	4 <sup>1</sup> / <sub>4</sub> (10.8)	3 <sup>3</sup> / <sub>8</sub> (8.6)	5 <sup>3</sup> / <sub>16</sub> (13.5)	5 <sup>1</sup> / <sub>4</sub> (13.4)
95 (241.3)			3 <sup>15</sup> / <sub>16</sub> (10.1)	4 <sup>3</sup> / <sub>8</sub> (11.2)	3 <sup>1</sup> / <sub>2</sub> (8.9)	5 <sup>1</sup> / <sub>2</sub> (14.0)	5 <sup>3</sup> / <sub>16</sub> (13.2)
100 (254.0)			4 <sup>1</sup> / <sub>16</sub> (10.4)	4 <sup>1</sup> / <sub>2</sub> (11.5)	3 <sup>5</sup> / <sub>8</sub> (9.3)	5 <sup>11</sup> / <sub>16</sub> (14.5)	5 <sup>7</sup> / <sub>16</sub> (13.9)
105 (266.7)			4 <sup>3</sup> / <sub>16</sub> (10.7)	4 <sup>3</sup> / <sub>8</sub> (11.8)	3 <sup>11</sup> / <sub>16</sub> (9.4)	5 <sup>1</sup> / <sub>8</sub> (15.0)	5 <sup>1</sup> / <sub>2</sub> (14.2)
110 (279.4)			4 <sup>5</sup> / <sub>16</sub> (11.0)	4 <sup>13</sup> / <sub>16</sub> (12.3)	3 <sup>13</sup> / <sub>16</sub> (9.7)	6 <sup>1</sup> / <sub>8</sub> (15.6)	5 <sup>11</sup> / <sub>16</sub> (14.5)
115 (292.1)			4 <sup>3</sup> / <sub>8</sub> (11.2)	4 <sup>15</sup> / <sub>16</sub> (12.6)	3 <sup>7</sup> / <sub>8</sub> (9.9)	6 <sup>3</sup> / <sub>16</sub> (16.1)	5 <sup>13</sup> / <sub>16</sub> (14.8)
120 (304.8)			4 <sup>1</sup> / <sub>2</sub> (11.5)	5 <sup>1</sup> / <sub>16</sub> (12.9)	4 (10.2)	6 <sup>1</sup> / <sub>2</sub> (16.6)	5 <sup>7</sup> / <sub>8</sub> (15.0)
125 (317.5)			4 <sup>5</sup> / <sub>8</sub> (11.8)	5 <sup>3</sup> / <sub>16</sub> (13.2)	4 <sup>1</sup> / <sub>8</sub> (10.5)		6 (15.3)

**NOTE:** Estimated finished blind heights include headrail and bottomrail.

# General Information

## Slat Count Chart

Finished Blind Height inches (cm)	Cordless Supreme	Cordless Supreme Hidden Holes	Supreme	Supreme Hidden Holes	Supreme 1/2" (1.3 cm) Micro	2" (5.1 cm) Grandeur™	Insignia™	Classics	Finished Blind Height inches (cm)	Cordless Supreme	Cordless Supreme Hidden Holes	Supreme	Supreme Hidden Holes	Supreme 1/2" (1.3 cm) Micro	2" (5.1 cm) Grandeur™	Insignia™	Classics
10 (25.4)			12	14	19	6	11	11	81 (205.8)	95		96	114	163	47	95	92
11 (28.0)			13	15	21	7	12	13	82 (208.3)	96		97	115	165	48	96	93
12 (30.5)	13	15	14	16	23	7	13	14	83 (210.9)	97		98	116	167	48	97	94
13 (33.1)	14	16	15	18	25	8	15	15	84 (213.4)	98		99	118	169	49	98	95
14 (35.6)	16	18	16	19	27	9	16	16	85 (215.9)			100	119	171	50	100	96
15 (38.1)	17	19	18	21	29	9	17	17	86 (218.5)			102	121	173	50	101	97
16 (40.7)	18	21	19	22	31	10	18	18	87 (221.0)			103	122	175	51	102	98
17 (43.2)	19	22	20	23	33	10	19	19	88 (223.6)			104	124	177	51	103	99
18 (45.8)	20	24	21	25	35	11	20	20	89 (226.1)			105	125	179	52	104	101
19 (48.3)	22	25	22	26	37	11	22	22	90 (228.6)			106	126	181	52	105	102
20 (50.8)	23	26	24	28	39	12	23	23	91 (231.2)			107	128	183	53	107	103
21 (53.4)	24	28	25	29	41	13	24	24	92 (233.7)			109	129	185	54	108	104
22 (55.9)	25	29	26	30	43	13	25	25	93 (236.3)			110	131	187	54	109	105
23 (58.5)	26	31	27	32	45	14	26	26	94 (238.8)			111	132	189	55	110	106
24 (61.0)	27	32	28	33	47	14	28	27	95 (241.3)			112	133	191	55	111	107
25 (63.5)	29	33	29	35	49	15	29	28	96 (243.9)			113	135	193	56	113	108
26 (66.1)	30	35	31	36	51	15	30	29	97 (246.4)			114	136	195	56	114	110
27 (68.6)	31	36	32	37	53	16	31	31	98 (249.0)			116	138	197	57	115	111
28 (71.2)	32	38	33	39	55	17	32	32	99 (251.5)			117	139	199	58	116	112
29 (73.7)	33	39	34	40	57	17	33	33	100 (254.0)			118	140	201	58	117	113
30 (76.2)	35	40	35	42	59	18	35	34	101 (256.6)			119	142	203	59	118	114
31 (78.8)	36	42	37	43	61	18	36	35	102 (259.1)			120	143	206	59	120	115
32 (81.3)	37	43	38	45	63	19	37	36	103 (261.7)			122	145	208	60	121	116
33 (83.9)	38	45	39	46	65	20	38	37	104 (264.2)			123	146	210	61	122	117
34 (86.4)	39	46	40	47	67	20	39	38	105 (266.7)			124	148	212	61	123	119
35 (88.9)	40	47	41	49	69	21	41	40	106 (269.3)			125	149	214	62	124	120
36 (91.5)	42	49	42	50	71	21	42	41	107 (271.8)			126	150	216	62	126	121
37 (94.0)	43	50	44	52	73	22	43	42	108 (274.4)			127	152	218	63	127	122
38 (96.6)	44	52	45	53	75	22	44	43	109 (276.9)			129	153		63	128	123
39 (99.1)	45	53	46	54	77	23	45	44	110 (279.4)			130	155		64	129	124
40 (101.6)	46	55	47	56	80	24	46	45	111 (282.0)			131	156		65	130	125
41 (104.2)	47	56	48	57	82	24	48	46	112 (284.5)			132	157		65	131	127
42 (106.7)	49	57	50	59	84	25	49	48	113 (287.1)			133	159		66	133	128
43 (109.3)	50	59	51	60	86	25	50	49	114 (289.6)			135	160		66	134	129
44 (111.8)	51	60	52	61	88	26	51	50	115 (292.1)			136	162		67	135	130
45 (114.3)	52	62	53	63	90	26	52	51	116 (297.7)			137	163		67	136	131
46 (116.9)	53	63	54	64	92	27	54	52	117 (297.2)			138	164		68	137	132
47 (119.4)	55	64	55	66	94	28	55	53	118 (299.8)			139	166		69	139	133
48 (122.0)	56	66	57	67	96	28	56	54	119 (302.3)			140	167		69	140	134
49 (124.5)	57	67	58	69	98	29	57	55	120 (304.8)			142	169		70	141	136
50 (127.0)	58	69	59	70	100	29	58	57	121 (307.4)			143	170		70	142	137
51 (129.6)	59	70	60	71	102	30	59	58	122 (309.9)			144	171		71	143	138
52 (132.1)	60	71	61	73	104	31	61	59	123 (312.5)			145	173		71	144	139
53 (134.7)	62	73	63	74	106	31	62	60	124 (315.0)			146	174		72	146	140
54 (137.2)	63	74	64	76	108	32	63	61	125 (317.5)			148	176		73	147	141
55 (139.7)	64	76	65	77	110	32	64	62	126 (320.1)			149	177		73	148	142
56 (142.3)	65	77	66	78	112	33	65	63	127 (322.6)			150	179		74	149	
57 (144.8)	66	79	67	80	114	33	67	64	128 (325.2)			151	180		74	150	
58 (147.4)	68	80	68	81	116	34	68	66	129 (327.7)			152	181		75	152	
59 (149.9)	69	81	70	83	118	35	69	67	130 (330.2)			153	183		76	153	
60 (152.4)	70	83	71	84	120	35	70	68	131 (332.8)			155	184		76	154	
61 (155.0)	71	84	72	85	122	36	71	69	132 (335.3)			156	186		77	155	
62 (157.5)	72	86	73	87	124	36	72	70	133 (337.9)			157	187		77	156	
63 (160.1)	73	87	74	88	126	37	74	71	134 (340.4)			158	188		78	157	
64 (162.6)	75	88	76	90	128	37	75	72	135 (342.9)			159	190		78	159	
65 (165.1)	76	90	77	91	130	38	76	73	136 (345.5)			161	191		79	160	
66 (167.7)	77	91	78	93	132	39	77	75	137 (348.0)			162	193		80	161	
67 (170.2)	78	93	79	94	134	39	78	76	138 (350.6)			163	194		80	162	
68 (172.8)	79	94	80	95	136	40	79	77	139 (353.1)			164	195		81	163	
69 (175.3)	81	95	81	97	138	40	81	78	140 (355.6)			165	197		81	165	
70 (177.8)	82	97	83	98	140	41	82	79	141 (358.2)			166	198		82	166	
71 (180.4)	83	98	84	100	143	41	83	80	142 (360.7)			168	200		82	167	
72 (182.9)	84	100	85	101	145	42	84	81	143 (363.3)			169	201		83	168	
73 (185.5)	85		86	102	147	43	85	83	144 (365.8)			170	203		84	169	
74 (188.0)	86		87	104	149	43	87	84	145 (368.3)			171	204		84	170	
75 (190.5)	88		89	105	151	44	88	85	146 (370.9)			172	205		85	172	
76 (193.1)	89		90	107	153	44	89	86	147 (373.4)			174	207		85	173	
77 (195.6)	90		91	108	155	45	90	87	148 (376.0)			175	208		86	174	
78 (198.2)	91		92	109	157	46	91	88	149 (378.5)			176	210		87	175	
79 (200.7)	92		93	111	159	46	92	89	150 (381.0)			177	211		87	176	
80 (203.2)	94		94	112	161	47	94	90									

# General Information

## Slat Route and Ladder Count

Blinds with two lift cords will have two clear plastic cord stop beads located approximately 2" (5.1 cm) below the headrail. Cords will continue down, each ending in a tassel. Blinds with three or more lift cords will have the cords joined together with a joiner ball approximately 2" (5.1 cm) below the headrail. Two individual cords will continue down, each ending in a tassel.

### Cordless Supreme

#### For Standard or Reverse Controls

Finished Blind Width inches (cm)	Slat End Route inches (cm)	# of Ladders	# of Lifts	# of Center Brackets
16 (40.7) to 17 <sup>15</sup> / <sub>16</sub> (45.6)	5 <sup>1</sup> / <sub>2</sub> (14.0)	2	2	2
18 (45.8) to 20 <sup>15</sup> / <sub>16</sub> (53.2)	6 (15.3)	2	2	2
21 (53.4) to 37 (94.0)	6 <sup>1</sup> / <sub>2</sub> (16.6)	2	2	2
37 (94.0) to 61 (155.0)	6 <sup>1</sup> / <sub>2</sub> (16.6)	3	2	2, 3 over 42" (106.7 cm)
61 (155.0) to 85 (215.9)	6 <sup>1</sup> / <sub>2</sub> (16.6)	4	4	3, 4 over 72" (182.9 cm)
85 (215.9) to 109 (276.9)	6 <sup>1</sup> / <sub>2</sub> (16.6)	5	4	4, 5 over 102" (259.1 cm)

#### NOTES:

1. Maximum spacing between ladders is 24" (61.0 cm).
2. Standard control position: tilt left.

### Supreme with Side Mount Brackets

#### For Standard or Reverse Controls

Finished Blind Width inches (cm)	Slat End Route inches (cm)	# of Ladders	# of Lifts
7 <sup>1</sup> / <sub>2</sub> (19.1) to 8 <sup>15</sup> / <sub>16</sub> (22.8)	2 (5.1)	2	2
9 (22.9) to 11 <sup>15</sup> / <sub>16</sub> (30.4)	3 (7.7)	2	2
12 (30.5) to 20 <sup>15</sup> / <sub>16</sub> (53.2)	4 (10.2)	2	2
21 (53.4) to 37 (94.0)	6 <sup>1</sup> / <sub>2</sub> (16.6)	2	2
37 <sup>1</sup> / <sub>16</sub> (94.2) to 60 (152.4)	6 <sup>1</sup> / <sub>2</sub> (16.6)	3	2

#### For Same Side Controls

12 (30.5) to 20 <sup>15</sup> / <sub>16</sub> (53.2)	4 (10.2)	As above	As above
21 (53.4) to 60 (152.4)	6 <sup>1</sup> / <sub>2</sub> (16.6)	As above	As above

#### NOTES:

1. Maximum spacing between ladders is 24" (61.0 cm).
2. Standard control positions: lift right/tilt left.
3. Maximum spacing for using side mount brackets is 60" (152.4 cm).

### Supreme

#### Standard and Hidden Holes Option

Finished Blind Width inches (cm)	Slat End Route inches (cm)	# of Ladders	# of Lifts	# of Center Brackets
5 <sup>1</sup> / <sub>2</sub> (14.0) to 6 <sup>15</sup> / <sub>16</sub> (17.7)	1 <sup>1</sup> / <sub>2</sub> (3.9)	2	2	2
7 (17.8) to 8 <sup>15</sup> / <sub>16</sub> (22.8)	2 (5.1)	2	2	2
9 (22.9) to 11 <sup>15</sup> / <sub>16</sub> (30.4)	3 (7.7)	2	2	2
12 (30.5) to 20 <sup>15</sup> / <sub>16</sub> (53.2)	4 (10.2)	2	2	2
21 (53.4) to 37 (94.0)	6 <sup>1</sup> / <sub>2</sub> (16.6)	2	2	2
37 <sup>1</sup> / <sub>16</sub> (94.2) to 61 (155.0)	6 <sup>1</sup> / <sub>2</sub> (16.6)	3	2	2, 3 over 60" (152.4 cm) FBW
61 <sup>1</sup> / <sub>16</sub> (155.1) to 85 (215.9)	6 <sup>1</sup> / <sub>2</sub> (16.6)	4	4	3, 4 over 96" (243.9 cm) FBW
85 <sup>1</sup> / <sub>16</sub> (216.1) to 109 (276.9)	6 <sup>1</sup> / <sub>2</sub> (16.6)	5	4	4
109 <sup>1</sup> / <sub>16</sub> (277.1) to 133 (337.9)	6 <sup>1</sup> / <sub>2</sub> (16.6)	6	4	4
133 <sup>1</sup> / <sub>16</sub> (338.0) to 142 (360.7)	6 <sup>1</sup> / <sub>2</sub> (16.6)	7	4	4

#### For Same Side Controls

11 <sup>15</sup> / <sub>16</sub> (30.4) to 20 <sup>15</sup> / <sub>16</sub> (53.2)	4 (10.2)	As above	As above	As above
21 (53.4) to 142 <sup>15</sup> / <sub>16</sub> (360.7)	6 <sup>1</sup> / <sub>2</sub> (16.6)	As above	As above	As above

#### NOTES:

1. Maximum spacing between ladders is 24" (61.0 cm).
2. Standard control positions: lift right/tilt left.
3. Maximum slat width is 142" (360.7 cm). Wider blinds must be multiple stack.

### Classics

#### For Standard or Reverse Controls

Finished Blind Width inches (cm)	Slat End Route inches (cm)	# of Ladders	# of Lifts	# of Center Brackets
5 <sup>1</sup> / <sub>2</sub> (14.0) to 6 <sup>15</sup> / <sub>16</sub> (17.7)	1 <sup>1</sup> / <sub>16</sub> (4.3)	2	2	0
7 (17.8) to 8 <sup>15</sup> / <sub>16</sub> (22.8)	2 (5.1)	2	2	0
9 (22.9) to 11 <sup>15</sup> / <sub>16</sub> (30.4)	3 <sup>3</sup> / <sub>4</sub> (8.3)	2	2	0
12 (30.5) to 20 <sup>15</sup> / <sub>16</sub> (50.8)	4 (10.2)	2	2	0
21 (53.4) to 37 (94.0)	6 <sup>1</sup> / <sub>2</sub> (16.6)	2	2	0
37 <sup>1</sup> / <sub>16</sub> (94.2) to 61 (155.0)	6 <sup>1</sup> / <sub>2</sub> (16.6)	3	2	1 over 60" (152.4 cm) FBW
61 <sup>1</sup> / <sub>16</sub> (155.1) to 85 (215.9)	6 <sup>1</sup> / <sub>2</sub> (16.6)	4	4	1
85 <sup>1</sup> / <sub>16</sub> (216.1) to 109 (276.9)	6 <sup>1</sup> / <sub>2</sub> (16.6)	5	4	2 over 96" (243.9 cm) FBW
109 <sup>1</sup> / <sub>16</sub> (277.1) to 133 (337.9)	6 <sup>1</sup> / <sub>2</sub> (16.6)	6	4	2
133 <sup>1</sup> / <sub>16</sub> (338.0) to 143 <sup>3</sup> / <sub>4</sub> (365.2)	6 <sup>1</sup> / <sub>2</sub> (16.6)	7	4	2

#### For Same Side Controls

11 <sup>15</sup> / <sub>16</sub> (30.4) to 20 <sup>15</sup> / <sub>16</sub> (53.2)	4 (10.2)	As above	As above	As above
21 (53.4) to 142 <sup>15</sup> / <sub>16</sub> (360.7)	6 <sup>1</sup> / <sub>2</sub> (16.6)	As above	As above	As above

#### NOTES:

1. Maximum spacing between ladders is 24" (61.0 cm).
2. Standard control position: lift right/tilt left.



# General Information

## Slat Route and Ladder Count

Blinds with two lift cords will have two clear plastic cord stop beads located approximately 2" (5.1 cm) below the headrail. Cords will continue down, each ending in a tassel. Blinds with three or more lift cords will have the cords joined together with a joiner ball or tassel approximately 2" (5.1 cm) below the headrail. Two individual cords will continue down, each ending in a tassel.

### Insignia™

#### For Standard or Reverse Controls

Finished Blind Width inches (cm)	Slat End Route inches (cm)	# of Ladders	# of Lifts	# of Center Brackets
5½ (14.0) to 8½ (22.8)	1½ (3.9)	2	2	0
9 (22.9) to 11½ (30.4)	3 (7.7)	2	2	0
12 (30.5) to 20½ (53.2)	4 (10.2)	2	2	0
21 (53.4) to 37 (94.0)	6½ (16.6)	2	2	0
37½ (94.2) to 61 (155.0)	6½ (16.6)	3	2	1 over 48" (122.0 cm) FBW
61½ (155.1) to 85 (215.9)	6½ (16.6)	4	4	1
85½ (216.1) to 109 (279.9)	6½ (16.6)	5	4	2 over 96" (243.9 cm) FBW
109½ (277.1) to 120 (304.8)	6½ (16.6)	6	4	2

#### For Same Side Controls

11½ (30.4) to 20½ (53.2)	4 (10.2)	As above	As above	As above
21 (53.4) to 120 (304.8)	6½ (16.6)	As above	As above	As above

#### NOTES:

1. Maximum spacing between ladders is 24" (61.0 cm).
2. Standard control positions: lift right/tilt left.

### Micro Supreme with Side Mount Brackets

#### For Standard or Reverse Controls

Finished Blind Width inches (cm)	Slat End Route inches (cm)	# of Ladders	# of Lifts
7½ (19.1) to 8½ (22.8)	2 (5.1)	2	2
9 (22.9) to 11½ (30.4)	3 (7.7)	2	2
12 (30.5) to 22 (55.9)	4 (10.2)	2	2
22½ (56.1) to 36 (91.5)	4 (10.2)	3	2
36½ (91.6) to 50 (127.0)	4 (10.2)	4	2
50½ (127.2) to 60 (152.4)	4 (10.2)	5	4

#### For Same Side Controls

12 (30.5) to 22 (55.9)	4 (10.2)	2	2
22½ (56.1) to 36 (91.5)	4 (10.2)	3	2
36½ (91.6) to 50 (127.0)	4 (10.2)	4	2
50½ (127.2) to 60 (152.4)	4 (10.2)	5	4

#### NOTES:

1. Maximum spacing between ladders is 14" (35.6 cm).
2. Standard control positions: lift right/tilt left.
3. Maximum FBW for side mount brackets is 60" (152.4 cm).

### Micro Supreme

#### For Standard or Reverse Controls

Finished Blind Width inches (cm)	Slat End Route inches (cm)	# of Ladders	# of Lifts	# of Center Brackets
5½ (14.0) to 6½ (17.7)	1½ (3.9)	2	2	2
7 (17.8) to 8½ (22.8)	2 (5.1)	2	2	2
9 (22.9) to 11½ (30.4)	3 (7.7)	2	2	2
12 (30.5) to 22 (55.9)	4 (10.2)	2	2	2
22½ (56.1) to 36 (91.5)	4 (10.2)	3	2	2
36½ (91.6) to 50 (127.0)	4 (10.2)	4	2	2
50½ (127.2) to 64 (162.6)	4 (10.2)	5	4	3 over 60" (152.4 cm) FBW
64½ (162.8) to 78 (198.2)	4 (10.2)	6	4	3
78½ (198.3) to 92 (233.7)	4 (10.2)	7	4	4
92½ (233.9) to 106 (269.3)	4 (10.2)	8	4	4
106½ (269.4) to 120 (304.8)	4 (10.2)	9	4	

#### For Same Side Controls

12 (30.5) to 120 (304.8)	4 (10.2)	As above	As above	As above
--------------------------	----------	-------------	-------------	----------

#### NOTES:

1. Maximum spacing between ladders is 14" (35.6 cm).
2. Standard blinds: standard control positions: lift right/tilt left.

### Grandeur™ 2" (5.1 cm) Aluminum

#### For Standard or Reverse Controls

Finished Blind Width inches (cm)	Slat End Route inches (cm)	# of Ladders	# of Lifts	# of Center Brackets
9 (22.9) to 10 (25.4) on cord tilt only	2½ (6.1)	2	2	0
9 (22.9) to 11½ (30.4)	2½ (6.1)	2	2	0
12 (30.5) to 24 (61.0)	4 (10.2)	2	2	0
24½ (61.2) to 36 (91.5)	6 (15.3)	2	2	0
36½ (91.6) to 60 (152.4)	6 (15.3)	3	2	1 over 48" (122.0 cm) FBW
60½ (152.6) to 84 (213.4)	6 (15.3)	4	4	2 over 72" (182.9 cm) FBW
84½ (213.6) to 108 (274.4)	6 (15.3)	5	4	2
108½ (274.5) to 132 (335.3)	6 (15.3)	6	4	3
132½ (335.5) to 142 (360.7)	6 (15.3)	7	4	4

#### For Same Side Controls

16½ (40.8) to 36 (91.5)	6 (15.3)	2	2	0
36½ (91.6) to 60 (152.4)	6 (15.3)	3	2	1 over 48" (122.0 cm) FBW
60½ (152.6) to 84 (213.4)	6 (15.3)	4	4	2 over 72" (182.9 cm) FBW
84½ (213.6) to 108 (274.4)	6 (15.3)	5	4	2
108½ (274.5) to 132 (335.3)	6 (15.3)	6	4	3
132½ (335.5) to 142 (360.7)	6 (15.3)	7	4	4

#### NOTES:

1. Maximum spacing between ladders is 24" (61.0 cm).
2. Standard control position: lift right/tilt left.
3. Maximum headrail width for multiple stack blinds is 142" (360.7 cm). Maximum slat width is 142" (360.7 cm).

# General Information

## 1/2" (1.3 cm) Micro Supreme and 1" (2.6 cm) Supreme Product Detail

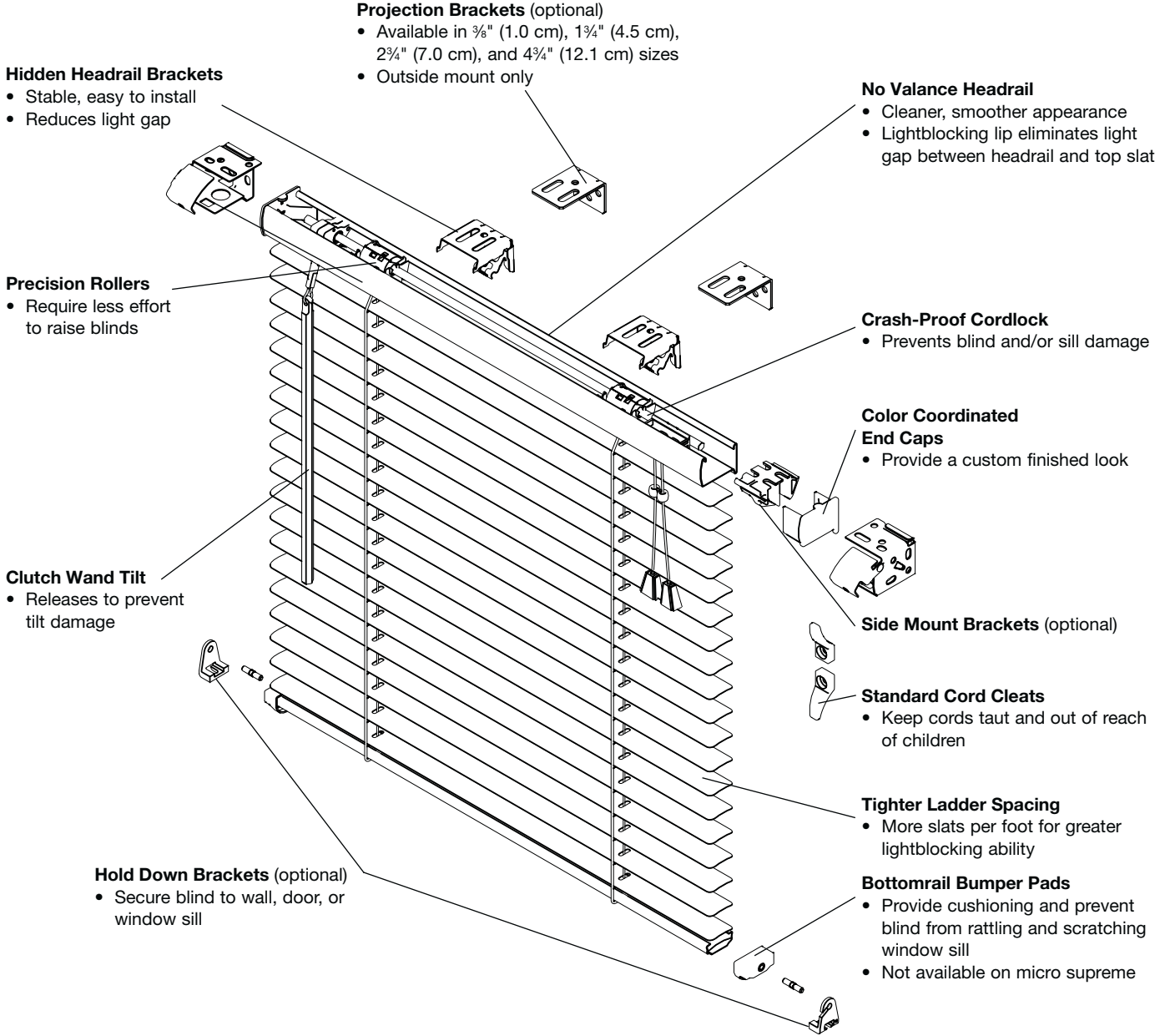

**NOTE:** A joiner ball is only used on blinds with three or more lift cords coming out of the cord lock.

# General Information

## 1" (2.6 cm) Cordless Supreme Product Detail

Cordless lift blinds are the safest window blind alternative; ideal for homes with children and pets. Elimination of lift cords and cord loops provides a more attractive appearance.

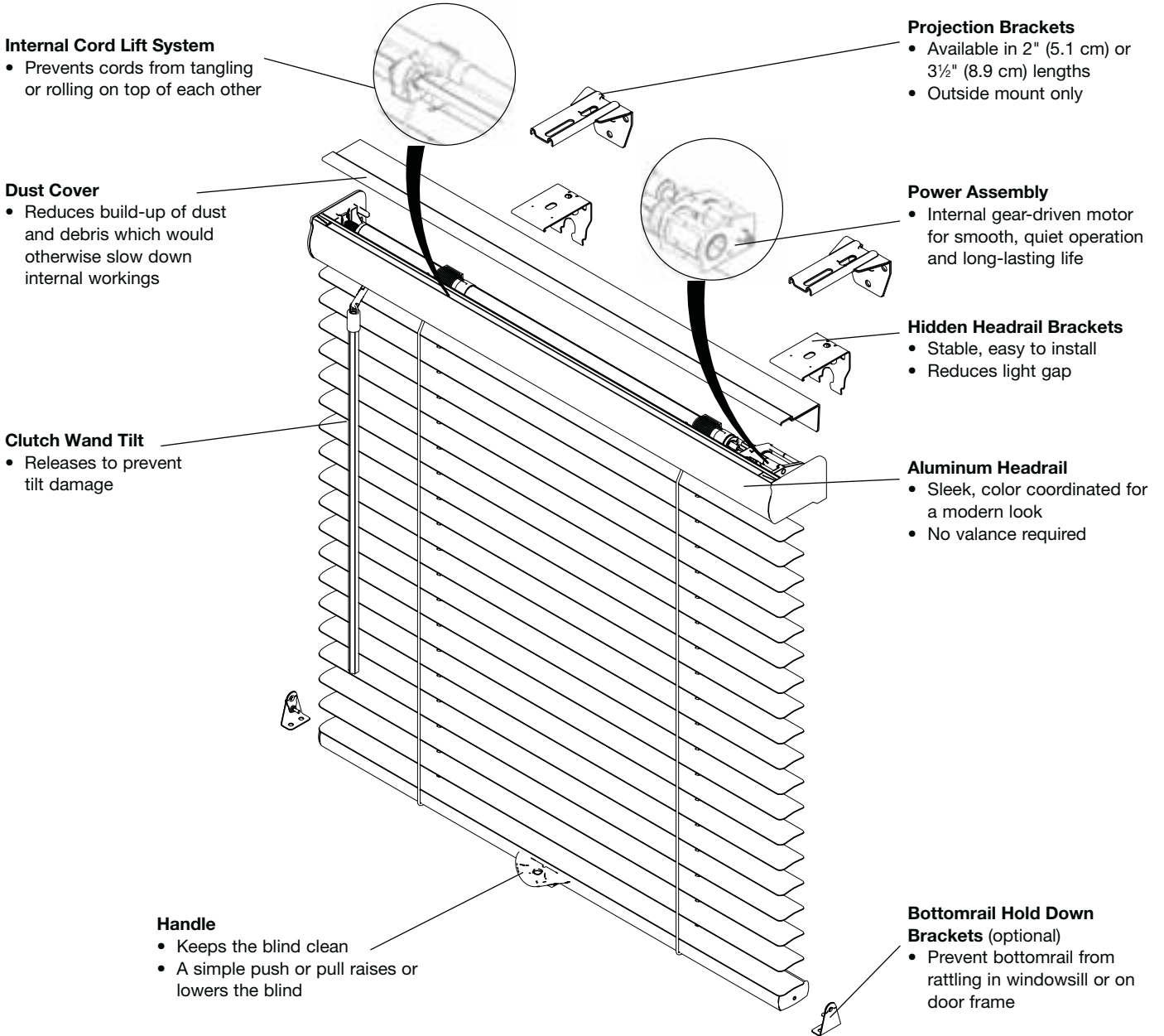

# General Information

## 1" (2.6 cm) Classics Product Detail

### Projection Brackets

- Available in short 1¾" (4.4 cm), medium 2¾" (7.0 cm), or long 4¾" (12.1 cm) lengths
- Outside mount only

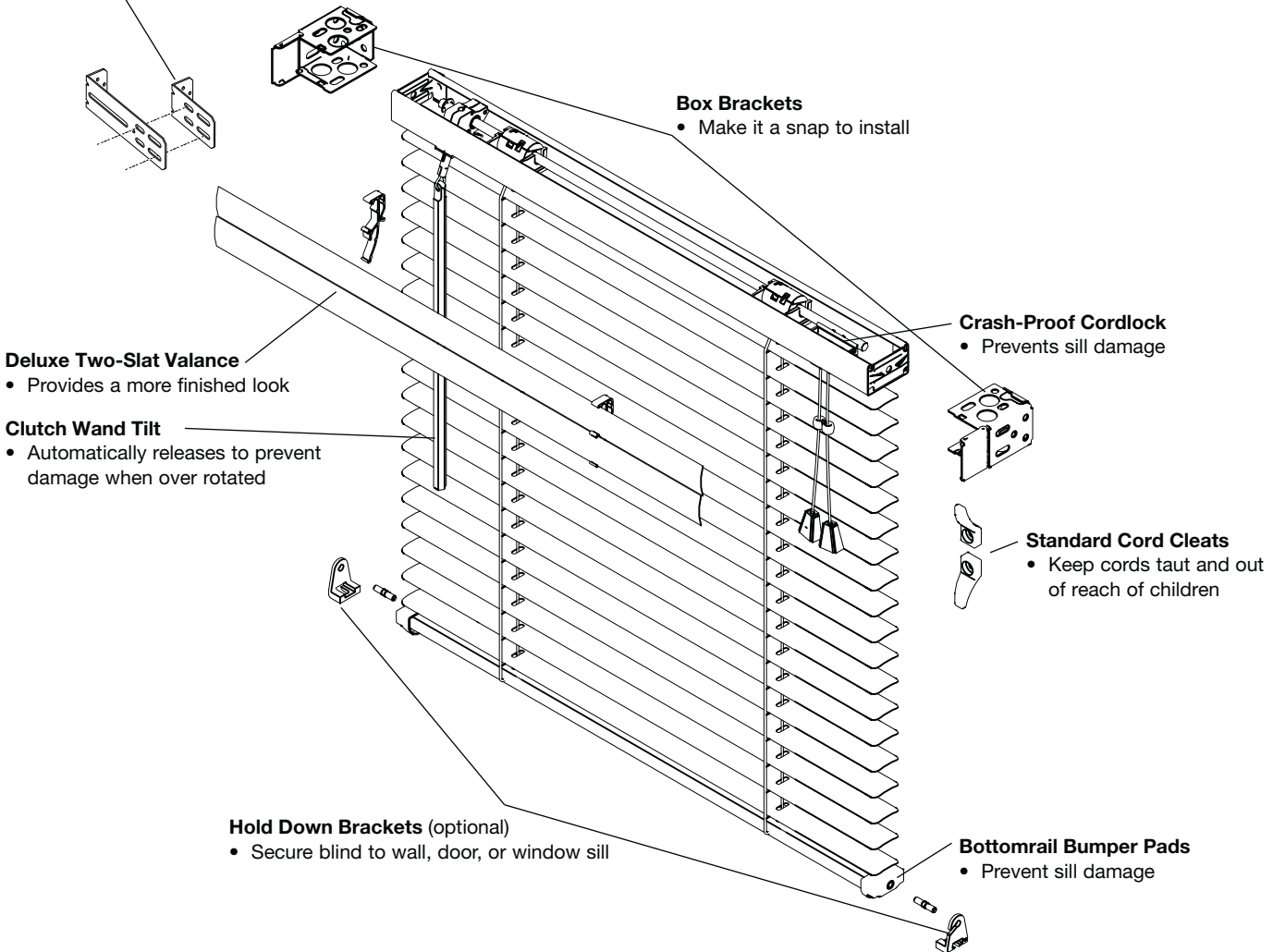

# General Information

## 1" (2.6 cm) Insignia™ Product Detail

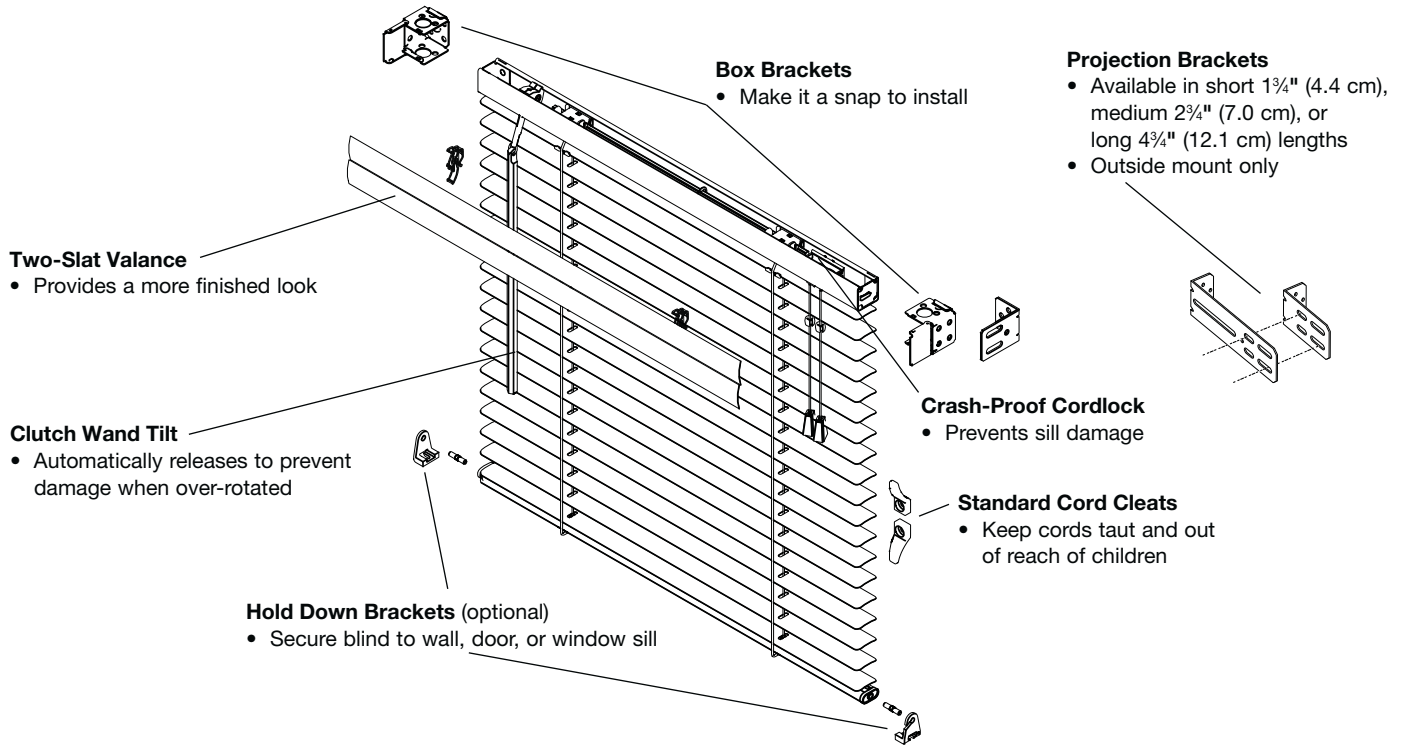

## 2" (5.1 cm) Grandeur™ Product Detail

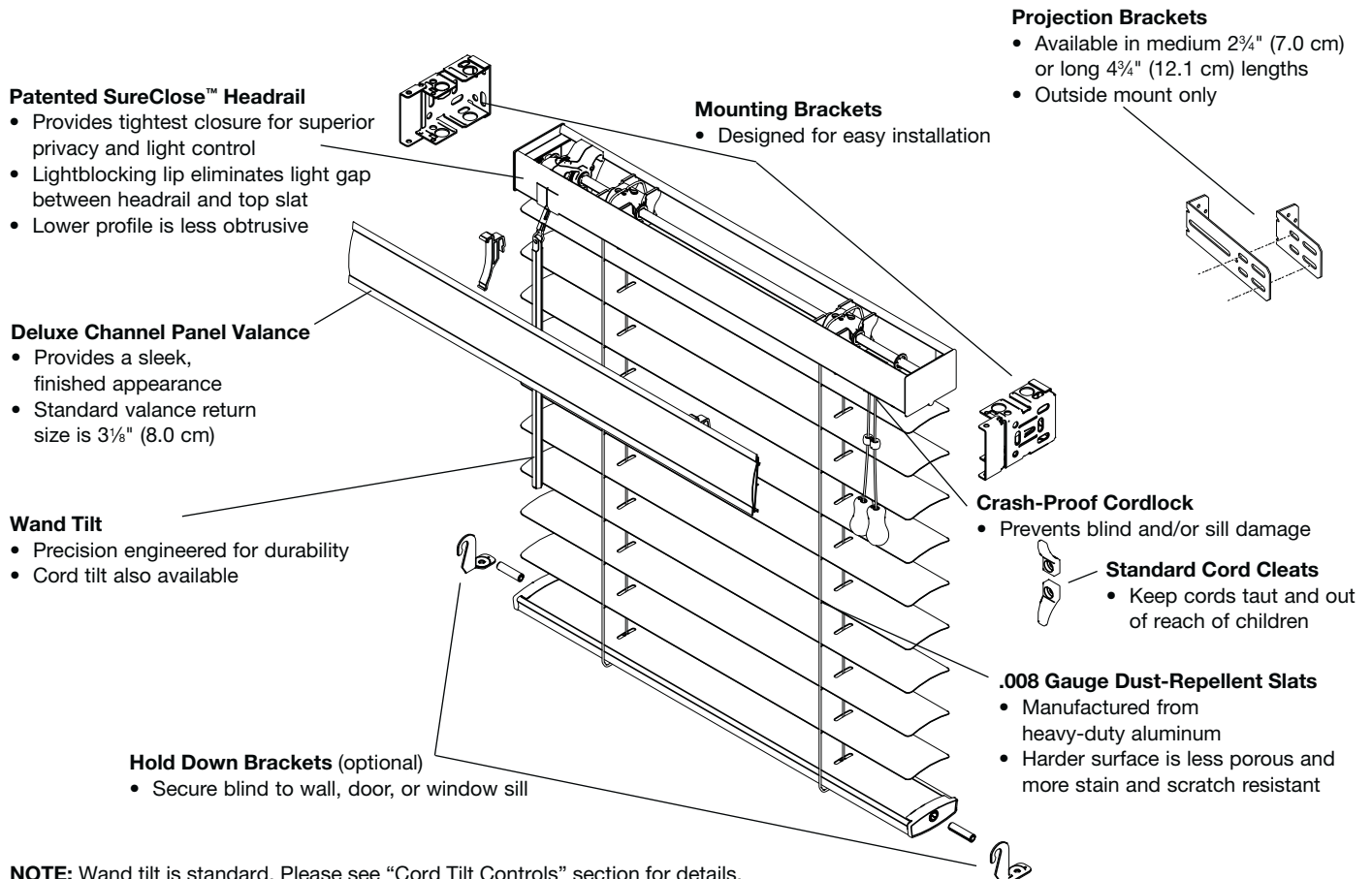

**NOTE:** Wand tilt is standard. Please see "Cord Tilt Controls" section for details.



# Price Charts

## Price Group A: 1" (2.6 cm) Cordless Supreme

### 1" (2.6 cm) Slats .006 Gauge

Height up to inches (cm)	Width up to inches (cm)																			
	23 (58.5)	26 (66.1)	29 (73.7)	32 (81.3)	36 (91.5)	40 (101.6)	44 (111.8)	48 (122.0)	52 (132.1)	57 (144.8)	62 (157.5)	67 (170.2)	72 (182.9)	82 (208.3)	92 (233.7)	102 (259.1)	112 (284.5)	122 (309.9)	132 (335.3)	144 (365.8)
42 (106.7)	\$179	185	190	208	215	230	246	258	271	290	301	320	336	398	428	470	498	531	599	626
48 (122.0)	183	189	205	215	229	241	257	272	286	307	322	340	355	419	458	495	525	565	632	667
54 (137.2)	187	204	212	220	238	253	268	284	295	325	342	356	379	443	483	522	560	596	667	704
60 (152.4)	200	211	216	235	249	262	280	295	310	341	356	379	394	464	503	553	590	628	701	739
66 (167.7)	205	215	232	246	257	276	290	308	332	354	373	391	416	486	524	581	617	661	739	781
72 (182.9)	211	225	239	250	271	286	304	328	342	371	391	412	440	508	555	606	649	699	773	816
78 (198.2)	220	232	246	257	279	296	319	341	355	385	409	435	456	536						
84 (213.4)	230	241	253	271	291	308	334	349	371	408	429	452	473							

### Surcharge: Hidden Holes™

Hidden Holes Surcharge	\$8	8	8	9	11	12	12	13	13	16	16	17	19	23	24	29	30	33	36	37

Hidden holes only available in sizes above the heavy line.

Maximum Size: Cordless lift: 6,400 square inches (4.2 m<sup>2</sup>)  
 Cordless lift with hidden holes:  
 5,900 square inches (3.8 m<sup>2</sup>)

Multiple Blinds on One Headrail:

Blinds less than 96" (243.9 cm): add surcharge: \$44 two-on-one headrail  
 \$44 three-on-one headrail  
 Blind widths 96" (243.9 cm) to 144" (365.8 cm): no charge

### 1" (2.6 cm) Slats .008 Gauge

Height up to inches (cm)	Width up to inches (cm)																			
	23 (58.5)	26 (66.1)	29 (73.7)	32 (81.3)	36 (91.5)	40 (101.6)	44 (111.8)	48 (122.0)	52 (132.1)	57 (144.8)	62 (157.5)	67 (170.2)	72 (182.9)	82 (208.3)	92 (233.7)	102 (259.1)	112 (284.5)	122 (309.9)	132 (335.3)	144 (365.8)
42 (106.7)	\$187	190	200	219	227	241	262	275	286	305	320	340	355	419	455	498	530	565	637	661
48 (122.0)	188	199	216	227	241	256	273	287	302	328	342	361	379	448	486	526	560	600	673	707
54 (137.2)	196	215	224	231	253	269	281	300	310	345	364	381	403	469	515	559	594	636	709	751
60 (152.4)	213	223	228	249	264	277	297	310	333	363	381	403	419	494	535	589	629	672	749	788
66 (167.7)	216	227	246	261	275	292	306	330	349	379	400	416	447	517	562	622	658	710	790	834
72 (182.9)	221	235	253	266	288	302	325	347	364	398	416	441	470	541	592	648	697	750	827	872
78 (198.2)	231	248	261	275	297	314	339	363	380	411	438	465	486	574						
84 (213.4)	242	254	271	288	308	333	354	372	399	435	459	480	508							

### Surcharge: Hidden Holes

Hidden Holes Surcharge	\$8	8	8	9	11	12	12	13	13	16	16	17	19	23	24	29	30	33	36	37

Hidden holes only available in sizes above the heavy line.

Maximum Size: Cordless lift: 6,400 square inches (4.2 m<sup>2</sup>)  
 Cordless lift with hidden holes:  
 5,900 square inches (3.8 m<sup>2</sup>)

Multiple Blinds on One Headrail:

Blinds less than 96" (243.9 cm): add surcharge: \$44 two-on-one headrail  
 \$44 three-on-one headrail  
 Blind widths 96" (243.9 cm) to 144" (365.8 cm): no charge

## Colors

Alabaster . . . . . 112	Coconut . . . . . 630	Milk Chocolate . . . . . 060	<b>Premium Colors</b>
Almost White Gloss . . . . . 065	Crystal White . . . . . 629	Princess Pink . . . . . 023	<b>(10% Surcharge)</b>
Aluminum . . . . . 034	Desert Sand . . . . . 625	Real Red . . . . . 085	Alabaster Pearl . . . . . 326
Beige . . . . . 011	Fawn . . . . . 031	Snowcap White . . . . . 386	Beige Pearl . . . . . 328
Black Satin . . . . . 233	Flax . . . . . 541	True Blue . . . . . 089	Brushed Aluminum . . . . . 121
Burgundy . . . . . 653	Hunter Green . . . . . 154	True White . . . . . 544	Fawn Pearl . . . . . 327
Cameo . . . . . 607	Lamplight . . . . . 904	Vanilla . . . . . 100	Polished Aluminum . . . . . 741
Canary Yellow . . . . . 009	Lavender Lace . . . . . 024		White Pearl . . . . . 637
Char Brown . . . . . 062	Little Boy Blue . . . . . 090		

# Price Charts

## Price Group B: 1" (2.6 cm) Supreme

### 1" (2.6 cm) Slats .006 Gauge

Height up to inches (cm)	Width up to inches (cm)																									
	12 (30.5)	23 (58.5)	26 (66.1)	29 (73.7)	32 (81.3)	36 (91.5)	40 (101.6)	44 (111.8)	48 (122.0)	52 (132.1)	57 (144.8)	62 (157.5)	67 (170.2)	72 (182.9)	82 (208.3)	92 (233.7)	102 (259.1)	112 (284.5)	122 (309.9)	132 (335.3)	142 (360.7)	152 (386.1)	162 (411.5)	172 (436.9)	182 (462.3)	192 (487.7)
42 (106.7)	\$109	89	92	101	112	120	132	147	154	165	183	193	209	220	248	275	314	336	366	397	417	447	476	506	534	565
48 (122.0)	112	92	101	114	120	134	147	158	168	181	203	213	231	243	275	307	339	366	401	434	460	495	531	567	602	639
54 (137.2)	119	101	114	120	125	147	158	168	181	190	220	239	248	268	299	333	369	401	438	468	504	540	578	613	649	649
60 (152.4)	132	114	120	125	146	158	168	183	193	209	239	251	272	284	322	355	401	438	472	507	540	581	622	661	702	743
66 (167.7)	135	118	125	146	154	168	183	193	209	230	251	272	285	309	346	379	434	465	508	548	585	627	669	710	752	794
72 (182.9)	140	122	134	151	162	181	193	209	230	243	272	289	309	333	369	411	460	504	548	585	625	670	715	761	807	852
78 (198.2)	152	132	147	158	168	190	204	225	243	256	285	309	333	353	400	438	493	532	582	625	666	712	759	806	852	900
84 (213.4)	164	146	154	168	181	203	220	240	251	275	309	332	353	369	423	461	522	570	622	661	704	754	806	856	906	957
90 (228.6)	169	151	165	177	190	213	239	248	272	285	322	346	366	397	443	493	548	600	651	702	751	806	859	913	967	1022
96 (243.9)	175	158	168	183	195	230	245	268	284	307	339	363	394	413	465	518	582	629	691	742	788	843	899	951	1007	1063
102 (259.1)	183	165	181	193	209	239	256	277	299	320	360	382	411	438	493	546	612	666	724	778	834	893	951	1010	1071	1130
108 (274.4)	192	172	188	203	220	245	272	289	314	336	372	401	434	456	518	574	644	697	760	816	875	937	996	1057	1116	1177
114 (289.6)	199	181	193	213	231	256	279	307	332	353	397	423	453	479	540	600	672	727	800	871	945	1010	1077	1145	1210	1277
120 (304.8)	201	183	203	225	243	272	289	320	342	366	411	438	468	504	570	626	702	766	828	889	951	1020	1085	1151	1218	1283
126 (320.1)	209	190	213	239	248	279	309	333	355	379	428	460	493	522	590	651	732	796	859	923	983	1052	1119	1190	1259	1326

### Surcharge: Hidden Holes™

Hidden Holes Surcharge	8	8	8	9	11	12	12	13	13	16	16	17	19	23	24	29	30	33	36	37	40	43	46	49	52	
\$8																										

**NOTE:** Smallest width available 5 1/2" (14.0 cm) exact. Widths from 5 1/2" (14.0 cm) to 8 3/16" (22.8 cm) are center tilt only.

Multiple Blinds on One Headrail: Blinds less than 142" (360.7 cm); add surcharge: \$44 two-on-one headrail Blind widths 142" (360.7 cm) to 192" (487.7 cm): no charge

### 1" (2.6 cm) Slats .008 Gauge

Height up to inches (cm)	Width up to inches (cm)																									
	12 (30.5)	23 (58.5)	26 (66.1)	29 (73.7)	32 (81.3)	36 (91.5)	40 (101.6)	44 (111.8)	48 (122.0)	52 (132.1)	57 (144.8)	62 (157.5)	67 (170.2)	72 (182.9)	82 (208.3)	92 (233.7)	102 (259.1)	112 (284.5)	122 (309.9)	132 (335.3)	142 (360.7)	152 (386.1)	162 (411.5)	172 (436.9)	182 (462.3)	192 (487.7)
42 (106.7)	\$118	98	102	111	124	132	147	164	170	181	200	211	231	243	275	303	342	371	401	438	456	492	528	564	599	636
48 (122.0)	120	102	111	125	132	150	164	173	185	199	225	239	251	268	303	336	373	401	442	476	507	546	585	625	663	703
54 (137.2)	128	111	125	132	136	164	173	185	199	209	243	262	275	294	326	366	408	442	479	516	554	594	636	676	715	755
60 (152.4)	146	125	132	136	158	173	185	200	211	231	262	278	300	314	355	392	442	479	517	560	591	637	681	724	768	812
66 (167.7)	149	128	136	158	170	185	200	211	231	249	278	300	315	339	380	417	476	513	562	602	644	689	736	781	826	871
72 (182.9)	153	133	150	168	174	199	211	231	249	268	300	319	339	366	408	452	507	554	602	644	686	737	788	836	887	938
78 (198.2)	165	147	164	173	185	209	227	245	268	282	315	339	366	384	441	479	544	585	641	686	732	783	834	886	938	989
84 (213.4)	175	158	170	185	199	225	243	263	278	303	339	364	384	408	465	508	574	627	683	730	775	829	885	941	995	1051
90 (228.6)	187	168	181	194	209	239	262	275	300	315	355	380	401	438	488	544	602	660	718	773	826	885	944	1003	1061	1119
96 (243.9)	193	173	185	200	213	249	270	294	314	336	373	398	434	455	513	570	641	692	760	815	867	927	987	1046	1107	1167
102 (259.1)	199	181	199	211	231	262	282	304	326	354	396	419	452	479	544	600	676	732	795	856	919	983	1046	1111	1175	1237
108 (274.4)	208	189	207	225	243	270	300	319	342	371	411	442	476	504	570	630	709	766	834	900	964	1029	1097	1161	1228	1296
114 (289.6)	216	199	211	239	251	282	308	336	364	384	438	465	499	526	591	660	738	800	881	959	1039	1113	1188	1262	1335	1406
120 (304.8)	220	200	225	245	268	300	319	354	379	401	452	479	516	554	627	687	773	844	911	980	1046	1119	1194	1268	1342	1416
126 (320.1)	229	209	239	262	275	308	339	366	392	417	472	507	544	574	648	718	807	875	945	1017	1081	1156	1231	1306	1381	1456

### Surcharge: Hidden Holes

Hidden Holes Surcharge	8	8	8	9	11	12	12	13	13	16	16	17	19	23	24	29	30	33	36	37	40	43	46	49	52	
\$8																										

**NOTE:** Smallest width available 5 1/2" (14.0 cm) exact. Widths from 5 1/2" (14.0 cm) to 8 3/16" (22.8 cm) are center tilt only.

Multiple Blinds on One Headrail: Blinds less than 142" (360.7 cm); add surcharge: \$44 two-on-one headrail Blind widths 142" (360.7 cm) to 192" (487.7 cm): no charge

## Colors

Alabaster	112	Flax	541	Parchment	535	<b>Premium Colors</b>	
Almond	724	Forest Shadow	087	Pitch Black	033	<b>(10% Surcharge)</b>	
Almost White Gloss	065	Granite	044	Princess Pink	023	Alabaster Pearl	326
Aluminum	034	Gray Dawn	405	Raw Umber	006	Ash Metallic	126
Beige	011	Gray Haze	983	Real Red	085	Beige Pearl	328
Birch White	375	Greige	122	Rock Gray	399	Brushed Aluminum	121
Black Satin	233	Hunter Green	154	Silver	737	Fawn Pearl	327
Buff	624	Ice	778	Skyline	680	Polished Aluminum	741
Burgundy	653	Lamplight	904	Smokey Gray	026	White Pearl	637
Cameo	607	Lavender Lace	024	Snowcap White	386		
Canary Yellow	009	Little Boy Blue	090	Stucco	963		
Char Brown	062	Magnet	648	Tender Taupe	103		
Coconut	630	Matte White	042	True Blue	089		
Creamy Beige	670	Mercury	771	True White	544		
Crystal White	629	Midnight Blue	057	U.N. Gray	095		
Desert Sand	625	Milk Chocolate	060	Vanilla	100		
Fawn	031	Navajo White	376	White Gloss	005		
				White Satin	205		



# Price Charts

## Price Group C: 1" (2.6 cm) Classics

### 1" (2.6 cm) Slats .006 Gauge

Height up to inches (cm) ↓	Width up to inches (cm) →																									
	12 (30.5)	23 (58.5)	26 (66.1)	29 (73.7)	32 (81.3)	36 (91.5)	40 (101.6)	44 (111.8)	48 (122.0)	52 (132.1)	57 (144.8)	62 (157.5)	67 (170.2)	72 (182.9)	82 (208.3)	92 (233.7)	102 (259.1)	112 (284.5)	122 (309.9)	132 (335.3)	142 (360.7)	152 (386.1)	162 (411.5)	172 (436.9)	182 (462.3)	192 (487.7)
42 (106.7)	\$108	88	92	100	111	119	131	143	153	164	181	190	208	218	246	272	309	334	363	394	413	443	472	500	530	563
48 (122.0)	111	92	100	113	119	133	143	157	167	178	200	212	229	241	272	304	336	363	398	429	456	490	526	563	597	630
54 (137.2)	118	100	113	119	124	143	157	167	178	188	218	235	246	264	295	330	365	398	432	462	498	534	571	608	644	679
60 (152.4)	131	113	119	124	142	157	167	181	190	208	235	249	270	281	319	352	398	432	468	503	534	575	615	655	696	733
66 (167.7)	134	117	124	142	153	167	181	190	208	228	249	270	282	306	342	373	429	460	504	542	580	622	661	703	745	785
72 (182.9)	138	121	133	150	159	178	190	208	228	241	270	287	306	330	365	408	456	498	542	580	618	662	707	754	799	843
78 (198.2)	151	131	143	157	167	188	201	223	241	253	282	306	330	349	397	432	488	528	576	618	658	704	752	798	844	887
84 (213.4)	163	142	153	167	178	200	218	238	249	272	306	328	349	365	418	457	517	566	615	655	698	748	798	847	897	945
90 (228.6)	168	150	164	175	188	212	235	246	270	282	319	342	363	394	439	488	542	594	645	696	744	798	851	904	959	1009
96 (243.9)	174	157	167	181	193	228	243	264	281	304	336	360	391	410	460	514	576	624	685	734	778	834	888	943	998	1052
102 (259.1)	181	164	178	190	208	235	253	275	295	316	356	378	408	432	488	540	606	658	717	770	826	885	943	1002	1059	1118
108 (274.4)	189	171	186	200	218	243	270	287	309	334	369	398	429	453	514	569	639	689	753	809	868	928	987	1046	1106	1166
114 (289.6)	196	178	190	212	229	253	277	304	328	349	394	418	449	475	534	594	663	719	793	863	936	1002	1066	1133	1198	1264
120 (304.8)	199	181	200	223	241	270	287	316	339	363	408	432	462	498	566	621	696	759	820	882	943	1008	1075	1140	1206	1272
126 (320.1)	208	188	212	235	246	277	306	330	352	373	423	456	488	517	584	645	724	789	851	915	975	1042	1110	1177	1247	1313

**NOTE:** Smallest width available 5½" (14.0 cm) exact.  
 Widths from 5½" (14.0 cm) to 8⅝" (22.8 cm) are center tilt only.  
 143¾" (365.2 cm) maximum single blind.

Multiple Blinds on One Headrail:  
 Blinds less than 142" (360.7 cm); add surcharge: \$44 two-on-one headrail  
 Blind widths 142" (360.7 cm) to 192" (487.7 cm): no charge

### 1" (2.6 cm) Slats .008 Gauge

Height up to inches (cm) ↓	Width up to inches (cm) →																									
	12 (30.5)	23 (58.5)	26 (66.1)	29 (73.7)	32 (81.3)	36 (91.5)	40 (101.6)	44 (111.8)	48 (122.0)	52 (132.1)	57 (144.8)	62 (157.5)	67 (170.2)	72 (182.9)	82 (208.3)	92 (233.7)	102 (259.1)	112 (284.5)	122 (309.9)	132 (335.3)	142 (360.7)	152 (386.1)	162 (411.5)	172 (436.9)	182 (462.3)	192 (487.7)
42 (106.7)	\$117	98	101	110	122	131	143	163	169	178	197	210	229	241	272	300	339	367	398	432	453	487	523	559	593	626
48 (122.0)	119	101	110	124	131	149	163	172	183	196	223	235	249	264	300	334	370	398	438	472	503	540	580	618	657	694
54 (137.2)	127	110	124	131	135	163	172	183	196	208	241	258	272	291	323	363	403	438	475	511	548	589	629	669	707	746
60 (152.4)	142	124	131	135	157	172	183	197	210	229	258	276	296	309	352	388	438	475	513	553	585	630	674	717	761	805
66 (167.7)	147	127	135	157	169	183	197	210	229	247	276	296	310	336	375	413	472	508	555	597	639	684	729	773	817	862
72 (182.9)	152	132	149	167	173	196	210	229	247	264	296	315	336	363	403	448	503	548	597	639	681	730	778	828	880	928
78 (198.2)	164	143	163	172	183	208	225	243	264	280	310	336	363	380	437	475	537	580	636	681	724	775	826	877	929	979
84 (213.4)	174	157	169	183	196	223	241	259	276	300	336	361	380	403	460	504	569	622	676	721	767	821	876	931	985	1041
90 (228.6)	185	167	178	192	208	235	258	272	296	310	352	375	398	432	484	537	597	654	712	766	817	876	934	994	1052	1110
96 (243.9)	190	172	183	197	212	247	268	291	309	334	370	395	429	452	508	566	636	686	753	808	858	919	978	1038	1097	1157
102 (259.1)	196	178	196	210	229	258	280	301	323	351	393	415	448	475	537	594	669	724	788	847	910	975	1038	1100	1164	1226
108 (274.4)	205	187	204	223	241	268	296	315	339	367	408	438	472	498	566	625	702	759	826	889	956	1020	1085	1151	1217	1284
114 (289.6)	215	196	210	235	249	280	305	334	361	380	432	460	493	522	585	654	731	793	872	948	1028	1102	1175	1249	1321	1395
120 (304.8)	218	197	223	243	264	296	315	351	373	398	448	475	511	548	622	682	766	835	902	969	1038	1110	1182	1255	1329	1403
126 (320.1)	227	208	235	258	272	305	336	363	388	413	468	503	537	569	643	712	799	868	936	1005	1071	1145	1220	1293	1367	1442

**NOTE:** Smallest width available 5½" (14.0 cm) exact.  
 Widths from 5½" (14.0 cm) to 8⅝" (22.8 cm) are center tilt only.  
 143¾" (365.2 cm) maximum single blind.

Multiple Blinds on One Headrail:  
 Blinds less than 142" (360.7 cm); add surcharge: \$44 two-on-one headrail  
 Blind widths 142" (360.7 cm) to 192" (487.7 cm): no charge

## Colors

Alabaster . . . . . 112 Almond . . . . . 724 Almost White Gloss . . . . . 065 Aluminum . . . . . 034 Beige . . . . . 011 Birch White . . . . . 375 Black Satin . . . . . 233 Buff . . . . . 624 Burgundy . . . . . 653 Cameo . . . . . 607 Char Brown . . . . . 062 Coconut . . . . . 630 Creamy Beige . . . . . 670 Crystal White . . . . . 629 Desert Sand . . . . . 625 Fawn . . . . . 031	Flax . . . . . 541 Forest Shadow . . . . . 087 Granite . . . . . 044 Gray Dawn . . . . . 405 Gray Haze . . . . . 983 Greige . . . . . 122 Hunter Green . . . . . 154 Ice . . . . . 778 Lamplight . . . . . 904 Magnet . . . . . 648 Matte White . . . . . 042 Mercury . . . . . 771 Midnight Blue . . . . . 057 Milk Chocolate . . . . . 060 Navajo White . . . . . 376 Parchment . . . . . 535	Pitch Black . . . . . 033 Raw Umber . . . . . 006 Real Red . . . . . 085 Rock Gray . . . . . 399 Silver . . . . . 737 Skyline . . . . . 680 Smokey Gray . . . . . 026 Snowcap White . . . . . 386 Stucco . . . . . 963 Tender Taupe . . . . . 103 True Blue . . . . . 089 True White . . . . . 544 U.N. Gray . . . . . 095 Vanilla . . . . . 100 White Gloss . . . . . 005 White Satin . . . . . 205	<b>Premium Colors (10% Surcharge)</b> Alabaster Pearl . . . . . 326 Ash Metallic . . . . . 126 Beige Pearl . . . . . 328 Brushed Aluminum . . . . . 121 Fawn Pearl . . . . . 327 Polished Aluminum . . . . . 741 White Pearl . . . . . 637
--	--	---	---

# Price Charts

## Price Group D: 1" (2.6 cm) Insignia™

1" (2.6 cm) Slats .006 Gauge

Height up to inches (cm)	Width up to inches (cm)																									
	12 (30.5)	23 (58.5)	26 (66.1)	29 (73.7)	32 (81.3)	36 (91.5)	40 (101.6)	44 (111.8)	48 (122.0)	52 (132.1)	57 (144.8)	62 (157.5)	67 (170.2)	72 (182.9)	82 (208.3)	92 (233.7)	102 (259.1)	112 (284.5)	120 (304.8)	130 (330.2)	140 (355.6)	150 (381.0)	160 (406.4)	170 (431.8)	180 (457.2)	192 (487.7)
42 (106.7)	\$95	76	80	90	96	108	114	120	126	139	158	166	181	187	211	233	265	287	312	339	364	392	417	443	470	495
48 (122.0)	101	80	90	97	107	116	124	133	140	151	172	184	193	208	233	259	290	314	347	375	403	432	461	489	518	547
54 (137.2)	109	90	97	107	111	124	133	146	156	165	185	197	211	228	253	281	317	345	372	406	440	473	507	540	572	606
60 (152.4)	116	97	107	111	119	133	146	158	166	181	201	213	231	242	276	303	345	370	408	443	478	515	551	586	623	658
66 (167.7)	120	103	111	119	126	146	158	166	183	192	215	232	246	264	295	326	366	399	435	473	511	550	587	626	663	702
72 (182.9)	125	108	117	125	134	154	166	181	192	203	232	248	264	281	317	349	394	428	469	509	550	590	630	672	712	752
78 (198.2)	132	114	124	133	146	165	177	189	203	220	246	264	281	299	337	372	417	453	495	539	582	625	668	710	753	796
84 (213.4)	137	120	128	140	156	172	185	203	215	232	264	280	299	317	358	394	443	484	528	572	620	663	709	754	799	845
90 (228.6)	143	125	139	151	164	183	197	213	231	245	276	295	314	337	380	415	470	511	559	605	653	701	749	796	844	890
96 (243.9)	153	133	146	159	172	192	208	228	241	262	290	309	332	353	399	442	495	540	587	637	685	734	783	831	881	929
102 (259.1)	158	139	154	166	181	201	220	235	253	271	307	326	349	370	417	469	521	568	622	674	725	778	830	883	936	988
108 (274.4)	165	147	159	173	187	210	231	248	269	287	319	345	366	389	442	490	551	596	646	701	754	808	862	915	968	1023
114 (289.6)	169	151	168	184	196	224	241	264	281	303	332	358	385	404	460	510	569	624	677	732	788	842	897	950	1005	1060
120 (304.8)	175	158	174	192	208	232	249	276	292	317	348	375	400	421	477	530	593	648	705	763	823	881	939	997	1056	1114
126 (320.1)	182	164	185	201	220	242	264	287	305	328	361	392	415	438	495	551	613	677	734	796	858	920	982	1043	1106	1167

**NOTE:** Smallest width available 5½" (14.0 cm) exact.  
Widths from 5½" (14.0 cm) to 8⅝" (22.8 cm) are center tilt only.

Multiple Blinds on One Headrail:  
Blinds less than 120" (304.8 cm): add surcharge: \$44 two-on-one headrail  
Blind widths 120" (304.8 cm) to 192" (487.7 cm): no charge

## Colors

Alabaster . . . . .	112	Fawn . . . . .	031	Real Red . . . . .	085	<b>Premium Colors (10% Surcharge)</b> Brushed Aluminum . . . . . 121 Polished Aluminum . . . . . 741
Almost White Gloss . . . . .	065	Flax . . . . .	541	Silver . . . . .	737	
Aluminum . . . . .	034	Forest Shadow . . . . .	087	Smokey Gray . . . . .	026	
Beige . . . . .	011	Granite . . . . .	044	Snowcap White . . . . .	386	
Black Satin . . . . .	233	Gray Haze . . . . .	983	Stucco . . . . .	963	
Buff . . . . .	624	Greige . . . . .	122	True Blue . . . . .	089	
Burgundy . . . . .	653	Ice . . . . .	778	True White . . . . .	544	
Cameo . . . . .	607	Lamplight . . . . .	904	U.N. Gray . . . . .	095	
Char Brown . . . . .	062	Matte White . . . . .	042	Vanilla . . . . .	100	
Coconut . . . . .	630	Milk Chocolate . . . . .	060	White Gloss . . . . .	005	
Creamy Beige . . . . .	670	Parchment . . . . .	535	White Satin . . . . .	205	
Crystal White . . . . .	629	Pitch Black . . . . .	033			
Desert Sand . . . . .	625	Raw Umber . . . . .	006			

## Price Charts

### Price Group E: 1/2" (1.3 cm) Micro Supreme

#### 1/2" (1.3 cm) Micro Supreme Blinds

Height up to inches (cm) ↓	Width up to inches (cm) →																										
	12 (30.5)	23 (58.5)	26 (66.1)	29 (73.7)	32 (81.3)	36 (91.5)	40 (101.6)	44 (111.8)	48 (122.0)	52 (132.1)	57 (144.8)	62 (157.5)	67 (170.2)	72 (182.9)	82 (208.3)	92 (233.7)	102 (259.1)	112 (284.5)	120 (304.8)	130 (330.2)	140 (355.6)	150 (381.0)	160 (406.4)	170 (431.8)	180 (457.2)	192 (487.7)	
42 (106.7)	\$127	110	116	122	132	153	164	174	186	199	227	239	257	273	307	339	373	422	455	499	492	531	570	610	648	688	729
48 (122.0)	133	116	122	136	147	166	177	190	203	216	244	262	284	300	339	373	422	455	499	542	586	630	676	719	763	808	
54 (137.2)	140	122	136	150	155	177	193	204	223	239	263	288	307	327	366	411	456	498	541	586	631	678	723	768	813	859	
60 (152.4)	154	134	147	155	170	190	204	225	239	257	289	307	333	354	400	438	498	537	586	638	687	738	789	837	888	939	
66 (167.7)	164	146	155	170	183	204	225	239	257	275	309	332	358	380	428	474	534	578	629	682	733	785	835	887	939	990	
72 (182.9)	171	153	168	183	194	220	239	257	275	294	332	358	380	411	456	506	570	622	677	733	790	846	903	959	1017	1072	
78 (198.2)	182	164	177	193	204	235	253	275	294	315	355	377	411	430	488	540	608	658	720	779	837	899	957	1017	1074	1134	
84 (213.4)	192	172	188	203	223	244	263	292	309	333	373	401	430	456	518	571	644	702	766	830	897	961	1026	1091	1156	1222	
90 (228.6)	201	183	199	215	234	257	288	304	332	353	396	424	455	487	548	605	685	743	809	874	942	1007	1074	1141	1206	1272	
96 (243.9)	209	190	204	230	244	275	300	323	346	371	417	448	483	513	580	640	720	779	851	921	990	1060	1131	1199	1270	1341	
102 (259.1)	220	200	220	239	257	289	315	337	364	388	441	468	506	537	608	673	754	824	899	970	1044	1117	1192	1266	1340	1413	
108 (274.4)	228	208	230	247	270	303	332	358	384	411	456	493	532	566	640	706	792	865	939	1018	1095	1171	1249	1325	1402	1480	

**NOTE:** Smallest width available 5 1/2" (14.0 cm) exact.  
Widths from 5 1/2" (14.0 cm) to 8 5/16" (22.8 cm) are center tilt only.

Multiple Blinds on One Headrail:  
Blinds less than 120" (304.8 cm): add surcharge: \$44 two-on-one headrail  
Blind widths 120" (304.8 cm) to 192" (487.7 cm): no charge

### Colors

Alabaster . . . . .	112	Fawn . . . . .	031	Pitch Black . . . . .	033	<b>Premium Colors (10% Surcharge)</b>		
Almost White Gloss . . . . .	065	Flax . . . . .	541	Raw Umber . . . . .	006			
Aluminum . . . . .	034	Gray Haze . . . . .	983	Smokey Gray . . . . .	026		Alabaster Pearl . . . . .	326
Beige . . . . .	011	Greige . . . . .	122	True White . . . . .	544		Brushed Aluminum . . . . .	121
Black Satin . . . . .	233	Lamplight . . . . .	904	Vanilla . . . . .	100		Fawn Pearl . . . . .	327
Char Brown . . . . .	062	Matte White . . . . .	042	White Gloss . . . . .	005			
Creamy Beige . . . . .	670	Milk Chocolate . . . . .	060	White Satin . . . . .	205			
Crystal White . . . . .	629	Parchment . . . . .	535					

# Price Charts

## Price Group F: 2" (5.1 cm) Grandeur™

### 2" (5.1 cm) Slats

Height up to inches (cm) ↓	Width up to inches (cm) →																				
	12 (30.5)	23 (58.5)	26 (66.1)	29 (73.7)	32 (81.3)	36 (91.5)	40 (101.6)	44 (111.8)	48 (122.0)	52 (132.1)	57 (144.8)	62 (157.5)	67 (170.2)	72 (182.9)	82 (208.3)	92 (233.7)	102 (259.1)	112 (284.5)	122 (309.9)	132 (335.3)	142 (360.7)
42 (106.7)	\$131	113	119	127	137	157	168	181	190	208	233	246	268	280	314	351	394	426	462	500	531
48 (122.0)	136	119	127	143	154	171	186	196	212	228	253	272	291	308	351	382	430	468	513	547	581
54 (137.2)	147	127	143	154	165	186	196	214	231	243	276	299	314	335	378	418	470	513	556	597	639
60 (152.4)	163	142	154	165	177	196	214	233	246	270	300	316	342	361	410	449	513	553	605	644	689
66 (167.7)	168	150	164	177	190	214	233	246	271	286	320	343	365	393	441	487	547	592	645	694	740
72 (182.9)	177	159	173	188	200	229	245	270	286	304	343	370	393	418	470	521	583	639	694	743	794
78 (198.2)	186	168	186	196	214	243	264	282	304	325	365	393	418	445	503	553	622	679	739	794	846
84 (213.4)	196	178	192	212	231	253	276	301	320	343	391	417	445	470	534	584	658	719	782	842	893
90 (228.6)	208	188	208	225	241	271	299	315	342	363	410	441	468	498	566	622	699	762	826	889	949
96 (243.9)	215	196	214	235	253	286	308	335	358	388	430	461	493	525	594	655	739	805	873	934	1004
102 (259.1)	229	210	229	245	270	300	325	352	378	404	456	488	521	553	624	694	771	846	923	990	1054
108 (274.4)	234	215	238	254	280	310	342	370	398	426	473	513	547	579	655	730	813	883	965	1038	1107
114 (289.6)	246	229	246	271	291	328	358	391	417	445	498	534	574	606	689	762	852	928	1013	1088	1157
120 (304.8)	253	235	254	281	304	342	370	401	432	461	521	556	597	637	719	798	890	969	1059	1135	1210
126 (320.1)	261	243	271	296	315	358	391	419	452	487	542	579	622	659	748	826	928	1007	1107	1180	1259

**NOTE:** Smallest width available 9" (22.9 cm) exact.  
Widths from 9" (22.9 cm) to 11<sup>15</sup>/<sub>16</sub>" (30.4 cm) are center tilt only.

Multiple Blinds on One Headrail:  
Blinds less than 120" (304.8 cm): add surcharge: \$44 two-on-one headrail  
Blind widths 120" (304.8 cm) to 142" (360.7 cm): no charge

### 2" (5.1 cm) Slats with Cloth Tapes

Height up to inches (cm) ↓	Width up to inches (cm) →																				
	12 (30.5)	23 (58.5)	26 (66.1)	29 (73.7)	32 (81.3)	36 (91.5)	40 (101.6)	44 (111.8)	48 (122.0)	52 (132.1)	57 (144.8)	62 (157.5)	67 (170.2)	72 (182.9)	82 (208.3)	92 (233.7)	102 (259.1)	112 (284.5)	122 (309.9)	132 (335.3)	142 (360.7)
42 (106.7)	\$156	136	142	153	165	188	201	217	229	249	280	295	321	336	377	422	473	511	554	599	637
48 (122.0)	163	142	153	172	185	205	224	235	255	274	303	326	349	370	422	458	516	561	615	656	698
54 (137.2)	175	153	172	185	198	224	235	257	277	291	332	358	377	402	454	502	564	615	668	717	766
60 (152.4)	195	171	185	198	212	235	257	280	295	323	360	379	411	432	492	539	615	663	725	773	827
66 (167.7)	201	180	197	212	229	257	280	295	325	342	384	412	438	471	529	584	656	710	775	834	888
72 (182.9)	212	192	208	226	240	275	294	323	342	365	412	444	471	502	564	625	700	766	834	891	952
78 (198.2)	224	201	224	235	257	291	317	339	365	391	438	471	502	534	603	663	746	815	887	952	1015
84 (213.4)	235	213	230	255	277	303	332	361	384	412	469	501	534	564	641	701	790	862	938	1010	1072
90 (228.6)	249	226	249	270	289	325	358	378	411	435	492	529	561	597	679	746	839	914	991	1067	1138
96 (243.9)	258	235	257	282	303	342	370	402	430	467	516	553	592	630	713	785	887	965	1048	1121	1205
102 (259.1)	275	251	275	294	323	360	391	423	454	486	547	585	625	663	749	834	926	1015	1109	1188	1265
108 (274.4)	281	258	285	304	336	372	411	444	477	511	567	615	656	694	785	875	976	1059	1158	1245	1329
114 (289.6)	295	275	295	325	349	394	430	469	501	534	597	641	688	727	827	914	1022	1113	1216	1305	1388
120 (304.8)	303	282	304	338	365	411	444	482	519	553	625	668	717	764	862	958	1068	1163	1271	1362	1452
126 (320.1)	314	291	325	355	378	430	469	503	541	584	651	694	746	791	898	991	1113	1208	1329	1417	1511

**NOTE:** Smallest width available 9" (22.9 cm) exact.  
Widths from 9" (22.9 cm) to 11<sup>15</sup>/<sub>16</sub>" (30.4 cm) are center tilt only.

Multiple Blinds on One Headrail:  
Blinds less than 120" (304.8 cm): add surcharge: \$44 two-on-one headrail  
Blind widths 120" (304.8 cm) to 142" (360.7 cm): no charge

## Colors

Alabaster . . . . . 112	Hunter Green . . . . . 154
Almond . . . . . 724	Lamplight . . . . . 904
Almost White Gloss . . . . . 065	Raw Umber . . . . . 006
Black Satin . . . . . 233	Snowcap White . . . . . 386
Char Brown . . . . . 062	Stucco . . . . . 963
Creamy Beige . . . . . 670	True White . . . . . 544
Gray Haze . . . . . 983	White Gloss . . . . . 005
Greige . . . . . 122	White Satin . . . . . 205

### Premium Colors (10% Surcharge)

Alabaster Pearl . . . . . 326
Ash Metallic . . . . . 126
Brushed Aluminum . . . . . 121
Polished Aluminum . . . . . 741

# Price Charts

## Price Group G: 1" (2.6 cm) Skylights

### Dual Headrail and Incline Wire Blinds .006 Gauge

Height up to inches (cm) ↓	Width up to inches (cm) →																				
	12 (30.5)	23 (58.5)	26 (66.1)	29 (73.7)	32 (81.3)	36 (91.5)	40 (101.6)	44 (111.8)	48 (122.0)	52 (132.1)	57 (144.8)	62 (157.5)	67 (170.2)	72 (182.9)	82 (208.3)	92 (233.7)	102 (259.1)	112 (284.5)	122 (309.9)	132 (335.3)	142 (360.7)
42 (106.7)	\$224	203	218	225	235	293	304	312	325	333	391	415	437	447	522	555	605	633	669	721	774
48 (122.0)	235	218	229	235	246	308	323	332	345	356	415	444	461	478	564	599	648	687	719	778	835
54 (137.2)	242	225	239	246	262	327	342	352	363	375	444	473	489	510	605	636	693	733	769	834	898
60 (152.4)	250	233	246	259	275	345	358	367	385	397	469	502	521	536	636	679	745	786	824	891	961
66 (167.7)	261	242	262	271	287	361	372	389	406	421	496	528	555	569	683	721	794	835	877	950	1023
72 (182.9)	273	253	272	285	301	375	392	408	424	443	521	559	583	603	700	761	842	883	929	1005	1081
78 (198.2)	286	268	286	299	317	397	411	426	443	462	556	593	617	643	762	813	905	951	996	1077	1158
84 (213.4)	293	275	294	307	327	408	426	448	464	480	569	612	639	667	794	845	930	984	1035		
90 (228.6)	303	285	307	319	342	426	448	467	483	503	599	639	672	693	834	884	980	1034	1090		
96 (243.9)	310	293	317	330	353	444	464	483	503	524	627	669	700	725	869	927					
102 (259.1)	323	304	328	345	365	463	480	503	528	551	648	693	727	730	910	969					
108 (274.4)	328	309	337	353	378	477	499	522	547	567	676										
114 (289.6)	343	324	352	365	392																
120 (304.8)	352	332	358	375	407																
126 (320.1)	362	345	367	389	421																

Incline wire available only in sizes to the left of the dotted line.

Dual headrail available only in sizes above the heavy line.

### Dual Headrail and Incline Wire Blinds .008 Gauge

Height up to inches (cm) ↓	Width up to inches (cm) →																				
	12 (30.5)	23 (58.5)	26 (66.1)	29 (73.7)	32 (81.3)	36 (91.5)	40 (101.6)	44 (111.8)	48 (122.0)	52 (132.1)	57 (144.8)	62 (157.5)	67 (170.2)	72 (182.9)	82 (208.3)	92 (233.7)	102 (259.1)	112 (284.5)	122 (309.9)	132 (335.3)	142 (360.7)
42 (106.7)	\$242	225	239	245	259	323	333	345	358	366	429	458	478	493	574	610	667	698	734	794	852
48 (122.0)	256	239	250	259	272	342	354	365	381	391	458	489	507	528	622	659	716	755	791	856	918
54 (137.2)	265	245	262	272	289	361	372	386	400	414	489	520	537	563	667	700	763	806	846	917	985
60 (152.4)	276	256	272	286	301	381	396	407	422	439	514	552	572	590	700	748	819	863	906	980	1057
66 (167.7)	285	268	289	299	315	397	411	428	444	463	547	581	610	628	751	794	872	918	967	1044	1122
72 (182.9)	299	280	300	312	330	414	433	447	467	488	572	613	641	663	769	840	924	970	1025	1105	1190
78 (198.2)	312	294	314	327	350	439	452	470	488	499	612	653	677	710	841	898	994	1046	1097	1188	1273
84 (213.4)	319	301	324	337	361	447	470	494	510	530	628	673	703	731	872	929	1026	1083	1140		
90 (228.6)	331	312	337	352	372	470	494	511	531	553	659	703	739	763	917	972	1079	1138	1198		
96 (243.9)	341	323	350	363	387	489	510	531	553	575	689	734	769	797	957	1023					
102 (259.1)	352	333	362	381	401	508	530	553	581	605	716	763	800	803	998	1066					
108 (274.4)	361	343	370	387	415	525	548	574	602	624	745										
114 (289.6)	373	356	386	401	433																
120 (304.8)	385	365	396	414	445																
126 (320.1)	398	381	407	428	463																

Incline wire available only in sizes to the left of the dotted line.

Dual headrail available only in sizes above the heavy line.

## Colors

Alabaster . . . . . 112	Flax . . . . . 541	Pitch Black . . . . . 033	<b>Premium Colors</b>
Almond . . . . . 724	Forest Shadow . . . . . 087	Raw Umber . . . . . 006	<b>(10% Surcharge)</b>
Almost White Gloss . . . . . 065	Granite . . . . . 044	Real Red . . . . . 085	Alabaster Pearl . . . . . 326
Aluminum . . . . . 034	Gray Dawn . . . . . 405	Rock Gray . . . . . 399	Ash Metallic . . . . . 126
Beige . . . . . 011	Gray Haze . . . . . 983	Silver . . . . . 737	Beige Pearl . . . . . 328
Birch White . . . . . 375	Greige . . . . . 122	Skyline . . . . . 680	Brushed Aluminum . . . . . 121
Black Satin . . . . . 233	Hunter Green . . . . . 154	Smokey Gray . . . . . 026	Fawn Pearl . . . . . 327
Buff . . . . . 624	Ice . . . . . 778	Snowcap White . . . . . 386	Polished Aluminum . . . . . 741
Burgundy . . . . . 653	Lamplight . . . . . 904	Stucco . . . . . 963	White Pearl . . . . . 637
Cameo . . . . . 607	Magnet . . . . . 648	Tender Taupe . . . . . 103	
Char Brown . . . . . 062	Matte White . . . . . 042	True Blue . . . . . 089	
Coconut . . . . . 630	Mercury . . . . . 771	True White . . . . . 544	
Creamy Beige . . . . . 670	Midnight Blue . . . . . 057	U.N. Gray . . . . . 095	
Crystal White . . . . . 629	Milk Chocolate . . . . . 060	Vanilla . . . . . 100	
Desert Sand . . . . . 625	Navajo White . . . . . 376	White Gloss . . . . . 005	
Fawn . . . . . 031	Parchment . . . . . 535	White Satin . . . . . 205	

# Price Charts

## Price Group H: 1" (2.6 cm) Skylights—Incline Wire Specialty Shapes

Incline Wire: Side Cuts, Inverted Triangles, Angle Tops and Bottoms .006 Gauge

Height up to inches (cm) ↓	Width up to inches (cm) →																		
	12 (30.5)	23 (58.5)	26 (66.1)	29 (73.7)	32 (81.3)	36 (91.5)	40 (101.6)	44 (111.8)	48 (122.0)	52 (132.1)	57 (144.8)	62 (157.5)	67 (170.2)	72 (182.9)	82 (208.3)	92 (233.7)	102 (259.1)	112 (284.5)	122 (309.9)
42 (106.7)	\$563	546	559	564	575	673	685	692	705	753	810	836	857	918	994	1026	1156	1188	1219
48 (122.0)	576	559	568	575	587	689	703	715	725	778	836	865	883	950	1035	1068	1201	1239	1269
54 (137.2)	583	564	580	587	603	707	721	731	745	797	865	892	911	981	1076	1107	1245	1284	1320
60 (152.4)	593	574	587	600	614	725	740	749	763	816	888	921	942	1007	1107	1150	1296	1338	1375
66 (167.7)	602	583	603	612	628	743	753	769	786	842	917	948	976	1041	1153	1193	1344	1386	1430
72 (182.9)	613	594	613	624	641	755	773	789	805	863	942	979	1004	1074	1170	1232	1392	1434	1481
78 (198.2)	627	609	627	637	659	779	792	806	824	872	977	1014	1037	1115	1234	1285	1454	1502	1548
84 (213.4)	632	614	633	646	669	789	806	830	845	903	991	1033	1060	1136	1264	1316	1482	1537	1587
90 (228.6)	642	624	646	661	681	806	830	846	863	922	1020	1060	1091	1165	1304	1354	1531	1585	1640
96 (243.9)	651	632	659	672	692	826	845	863	884	946	1046	1088	1119	1196	1342	1400			
102 (259.1)	663	643	671	685	705	844	861	884	910	970	1072	1115	1148	1201	1380	1439			
108 (274.4)	671	651	677	692	719	859	877	905	926	989	1097								
114 (289.6)	684	667	690	705	733														
120 (304.8)	690	673	700	717	747														
126 (320.1)	703	685	710	730	761														

Incline Wire: Side Cuts, Inverted Triangles, Angle Tops and Bottoms .008 Gauge

Height up to inches (cm) ↓	Width up to inches (cm) →																		
	12 (30.5)	23 (58.5)	26 (66.1)	29 (73.7)	32 (81.3)	36 (91.5)	40 (101.6)	44 (111.8)	48 (122.0)	52 (132.1)	57 (144.8)	62 (157.5)	67 (170.2)	72 (182.9)	82 (208.3)	92 (233.7)	102 (259.1)	112 (284.5)	122 (309.9)
42 (106.7)	\$583	564	580	585	600	703	716	725	740	789	851	877	901	965	1044	1081	1217	1250	1285
48 (122.0)	599	580	593	600	613	721	734	747	758	810	877	911	927	998	1091	1135	1265	1309	1342
54 (137.2)	605	585	603	613	629	743	753	767	783	835	911	941	959	1034	1136	1170	1316	1357	1397
60 (152.4)	617	599	613	627	641	758	778	788	803	859	935	972	994	1060	1170	1219	1372	1415	1456
66 (167.7)	627	609	629	637	658	779	792	807	826	884	967	1002	1030	1100	1223	1264	1424	1469	1517
72 (182.9)	637	620	639	653	672	796	811	829	846	910	994	1034	1061	1135	1240	1310	1477	1522	1575
78 (198.2)	653	633	657	669	689	816	834	851	868	918	1033	1074	1100	1180	1311	1366	1545	1598	1647
84 (213.4)	661	641	667	677	701	829	851	873	891	950	1048	1095	1122	1202	1344	1401	1576	1635	1691
90 (228.6)	672	653	677	690	716	851	873	892	913	975	1079	1122	1159	1235	1387	1442	1631	1688	1749
96 (243.9)	681	663	689	704	729	869	891	913	931	996	1111	1156	1192	1267	1427	1494			
102 (259.1)	692	675	703	720	744	889	911	931	963	1026	1136	1188	1222	1274	1469	1537			
108 (274.4)	701	683	712	729	755	908	927	956	981	1044	1165								
114 (289.6)	716	694	727	744	773														
120 (304.8)	725	705	738	753	788														
126 (320.1)	739	720	747	768	803														

## Colors

Alabaster . . . . . 112	Flax . . . . . 541	Pitch Black . . . . . 033	<b>Premium Colors</b>
Almond . . . . . 724	Forest Shadow . . . . . 087	Raw Umber . . . . . 006	<b>(10% Surcharge)</b>
Almost White Gloss . . . . . 065	Granite . . . . . 044	Real Red . . . . . 085	Alabaster Pearl . . . . . 326
Aluminum . . . . . 034	Gray Dawn . . . . . 405	Rock Gray . . . . . 399	Ash Metallic . . . . . 126
Beige . . . . . 011	Gray Haze . . . . . 983	Silver . . . . . 737	Beige Pearl . . . . . 328
Birch White . . . . . 375	Greige . . . . . 122	Skyline . . . . . 680	Brushed Aluminum . . . . . 121
Black Satin . . . . . 233	Hunter Green . . . . . 154	Smokey Gray . . . . . 026	Fawn Pearl . . . . . 327
Buff . . . . . 624	Ice . . . . . 778	Snowcap White . . . . . 386	Polished Aluminum . . . . . 741
Burgundy . . . . . 653	Lamplight . . . . . 904	Stucco . . . . . 963	White Pearl . . . . . 637
Cameo . . . . . 607	Magnet . . . . . 648	Tender Taupe . . . . . 103	
Char Brown . . . . . 062	Matte White . . . . . 042	True Blue . . . . . 089	
Coconut . . . . . 630	Mercury . . . . . 771	True White . . . . . 544	
Creamy Beige . . . . . 670	Midnight Blue . . . . . 057	U.N. Gray . . . . . 095	
Crystal White . . . . . 629	Milk Chocolate . . . . . 060	Vanilla . . . . . 100	
Desert Sand . . . . . 625	Navajo White . . . . . 376	White Gloss . . . . . 005	
Fawn . . . . . 031	Parchment . . . . . 535	White Satin . . . . . 205	

# Price Charts

## Price Group H: 1" (2.6 cm) Skylights—Incline Wire Specialty Shapes

### Incline Wire: Octagons, Triangles, and Other Shapes .006 Gauge

Height up to inches (cm) ↓	Width up to inches (cm) →																		
	12 (30.5)	23 (58.5)	26 (66.1)	29 (73.7)	32 (81.3)	36 (91.5)	40 (101.6)	44 (111.8)	48 (122.0)	52 (132.1)	57 (144.8)	62 (157.5)	67 (170.2)	72 (182.9)	82 (208.3)	92 (233.7)	102 (259.1)	112 (284.5)	122 (309.9)
42 (106.7)	\$674	657	669	675	686	803	813	824	836	906	963	985	1007	1110	1183	1217	1386	1416	1449
48 (122.0)	686	669	679	686	698	819	834	844	856	926	985	1017	1033	1141	1226	1259	1431	1469	1500
54 (137.2)	692	675	689	698	715	840	852	861	873	947	1017	1042	1060	1172	1265	1298	1477	1514	1552
60 (152.4)	703	685	698	710	725	856	869	878	895	969	1038	1073	1091	1197	1298	1342	1526	1565	1604
66 (167.7)	713	692	715	721	739	871	885	901	916	991	1067	1100	1125	1232	1344	1382	1575	1618	1661
72 (182.9)	724	704	724	734	751	887	905	918	935	1014	1091	1130	1153	1264	1361	1423	1623	1663	1712
78 (198.2)	738	719	738	748	768	910	921	937	952	1025	1126	1164	1189	1305	1424	1477	1685	1734	1778
84 (213.4)	744	725	745	756	779	918	937	961	976	1052	1143	1181	1211	1326	1454	1507	1714	1766	1816
90 (228.6)	752	734	756	769	792	937	961	977	994	1074	1168	1211	1241	1356	1496	1545	1760	1815	1871
96 (243.9)	761	744	768	783	803	956	976	994	1014	1096	1197	1239	1270	1386	1531	1589			
102 (259.1)	773	753	782	796	815	975	991	1014	1038	1119	1222	1265	1298	1391	1569	1631			
108 (274.4)	782	761	789	803	829	989	1008	1034	1057	1140	1248								
114 (289.6)	794	774	801	815	844														
120 (304.8)	801	784	809	827	857														
126 (320.1)	812	796	819	841	871														

### Incline Wire: Octagons, Triangles, and Other Shapes .008 Gauge

Height up to inches (cm) ↓	Width up to inches (cm) →																		
	12 (30.5)	23 (58.5)	26 (66.1)	29 (73.7)	32 (81.3)	36 (91.5)	40 (101.6)	44 (111.8)	48 (122.0)	52 (132.1)	57 (144.8)	62 (157.5)	67 (170.2)	72 (182.9)	82 (208.3)	92 (233.7)	102 (259.1)	112 (284.5)	122 (309.9)
42 (106.7)	\$692	675	689	694	710	834	845	856	869	938	999	1029	1051	1153	1235	1270	1445	1479	1515
48 (122.0)	707	689	703	710	724	852	865	875	889	963	1029	1060	1079	1190	1283	1318	1497	1539	1571
54 (137.2)	716	694	715	724	740	871	885	898	913	984	1060	1090	1110	1224	1326	1361	1546	1588	1629
60 (152.4)	728	707	724	738	751	889	908	917	931	1008	1086	1120	1144	1251	1361	1409	1602	1645	1686
66 (167.7)	738	719	740	748	767	910	921	938	956	1034	1116	1152	1180	1288	1413	1454	1656	1699	1748
72 (182.9)	748	730	749	762	783	924	944	959	977	1058	1144	1183	1213	1324	1431	1500	1706	1752	1805
78 (198.2)	762	745	763	779	800	948	965	980	998	1068	1181	1224	1250	1372	1501	1558	1776	1829	1877
84 (213.4)	770	751	774	789	810	959	980	1005	1023	1101	1198	1243	1274	1392	1535	1592	1806	1865	1921
90 (228.6)	783	762	789	801	826	980	1005	1025	1041	1122	1229	1274	1310	1425	1578	1633	1861	1919	1981
96 (243.9)	792	773	800	813	840	999	1023	1041	1063	1148	1260	1305	1342	1458	1619	1684			
102 (259.1)	804	786	811	830	854	1021	1039	1063	1091	1175	1285	1338	1372	1465	1661	1726			
108 (274.4)	810	794	822	840	866	1037	1058	1086	1112	1196	1316								
114 (289.6)	826	806	836	854	884														
120 (304.8)	835	815	846	865	898														
126 (320.1)	850	830	857	877	914														

## Colors

Alabaster . . . . . 112	Flax . . . . . 541	Pitch Black . . . . . 033	<b>Premium Colors</b>
Almond . . . . . 724	Forest Shadow . . . . . 087	Raw Umber . . . . . 006	<b>(10% Surcharge)</b>
Almost White Gloss . . . 065	Granite . . . . . 044	Real Red . . . . . 085	Alabaster Pearl . . . . . 326
Aluminum . . . . . 034	Gray Dawn . . . . . 405	Rock Gray . . . . . 399	Ash Metallic . . . . . 126
Beige . . . . . 011	Gray Haze . . . . . 983	Silver . . . . . 737	Beige Pearl . . . . . 328
Birch White . . . . . 375	Greige . . . . . 122	Skyline . . . . . 680	Brushed Aluminum . . . . 121
Black Satin . . . . . 233	Hunter Green . . . . . 154	Smokey Gray . . . . . 026	Fawn Pearl . . . . . 327
Buff . . . . . 624	Ice . . . . . 778	Snowcap White . . . . . 386	Polished Aluminum . . . . 741
Burgundy . . . . . 653	Lamplight . . . . . 904	Stucco . . . . . 963	White Pearl . . . . . 637
Cameo . . . . . 607	Magnet . . . . . 648	Tender Taupe . . . . . 103	
Char Brown . . . . . 062	Matte White . . . . . 042	True Blue . . . . . 089	
Coconut . . . . . 630	Mercury . . . . . 771	True White . . . . . 544	
Creamy Beige . . . . . 670	Midnight Blue . . . . . 057	U.N. Gray . . . . . 095	
Crystal White . . . . . 629	Milk Chocolate . . . . . 060	Vanilla . . . . . 100	
Desert Sand . . . . . 625	Navajo White . . . . . 376	White Gloss . . . . . 005	
Fawn . . . . . 031	Parchment . . . . . 535	White Satin . . . . . 205	

# Price Charts

## Price Group I: Arches

### 1" (2.6 cm) Slats .006 Gauge

Height up to inches (cm) ↓	Width up to inches (cm) →																				
	12 (30.5)	23 (58.5)	26 (66.1)	29 (73.7)	32 (81.3)	36 (91.5)	40 (101.6)	44 (111.8)	48 (122.0)	52 (132.1)	57 (144.8)	62 (157.5)	67 (170.2)	72 (182.9)	82 (208.3)	92 (233.7)	102 (259.1)	112 (284.5)	122 (309.9)	132 (335.3)	142 (360.7)
42 (106.7)	\$792	774	779	786	797	805	815	830	942	950	969	979	995	1005	1034	1058	1135	1158	1222	1251	1269
48 (122.0)	916	899	906	918	924	941	950	963	1009	1025	1044	1057	1073	1120	1153	1183	1259	1284	1359	1389	1416
54 (137.2)	1007	989	1002	1008	1014	1034	1044	1053	1107	1116	1145	1162	1174	1229	1259	1295	1372	1403	1477	1508	1541
60 (152.4)	1104	1086	1091	1097	1115	1130	1138	1152	1202	1219	1245	1260	1280	1328	1365	1397	1485	1520	1593	1629	1661
66 (167.7)	1190	1170	1178	1197	1206	1219	1234	1243	1300	1318	1343	1361	1375	1436	1471	1502	1598	1631	1712	1749	1786
72 (182.9)	1344	1326	1340	1354	1362	1382	1394	1410	1440	1454	1482	1500	1520	1543	1578	1619	1815	1859	1916	1951	1988
78 (198.2)	1438	1420	1434	1443	1453	1477	1487	1508	1539	1552	1579	1603	1626	1641	1692	1726	1930	1970	2032	2072	2111
84 (213.4)	1532	1514	1525	1537	1549	1571	1588	1606	1632	1653	1686	1709	1726	1745	1798	1835	2042	2090	2152	2192	2234
90 (228.6)	1540	1522	1532	1546	1559	1584	1604	1618	1651	1663	1698	1722	1743	1773	1816	1865	2066	2118	2183	2232	2278
96 (243.9)	1546	1527	1537	1552	1564	1596	1614	1633	1662	1684	1717	1740	1769	1788	1838	1890	2101	2145	2221	2269	2313
102 (259.1)	1552	1532	1549	1561	1578	1604	1623	1641	1676	1696	1736	1756	1785	1810	1865	1916	2130	2181	2253	2307	2361
108 (274.4)	1559	1541	1556	1571	1588	1614	1637	1656	1691	1714	1748	1777	1806	1831	1890	1944	2161	2211	2289	2342	2399
114 (289.6)	1568	1549	1561	1584	1598	1623	1646	1670	1709	1726	1773	1798	1826	1853	1911	1970	2187	2241	2327	2395	2470
120 (304.8)	1569	1552	1571	1592	1608	1637	1656	1685	1719	1743	1785	1810	1840	1874	1941	1993	2217	2278	2356	2416	2476
126 (320.1)	1578	1559	1584	1604	1618	1646	1676	1698	1729	1753	1802	1834	1865	1894	1960	2021	2246	2309	2384	2446	2504

### 1" (2.6 cm) Slats .008 Gauge

Height up to inches (cm) ↓	Width up to inches (cm) →																				
	12 (30.5)	23 (58.5)	26 (66.1)	29 (73.7)	32 (81.3)	36 (91.5)	40 (101.6)	44 (111.8)	48 (122.0)	52 (132.1)	57 (144.8)	62 (157.5)	67 (170.2)	72 (182.9)	82 (208.3)	92 (233.7)	102 (259.1)	112 (284.5)	122 (309.9)	132 (335.3)	142 (360.7)
42 (106.7)	\$801	784	788	796	807	815	830	845	957	967	985	996	1017	1028	1058	1086	1164	1192	1256	1288	1310
48 (122.0)	924	908	916	929	937	952	966	977	1028	1041	1066	1079	1095	1145	1180	1214	1293	1318	1397	1431	1463
54 (137.2)	1019	998	1014	1021	1026	1048	1060	1072	1125	1136	1167	1188	1198	1256	1287	1326	1408	1440	1517	1554	1589
60 (152.4)	1115	1097	1104	1110	1130	1144	1153	1170	1222	1239	1269	1285	1305	1357	1397	1434	1525	1561	1637	1679	1712
66 (167.7)	1201	1181	1192	1211	1223	1235	1253	1262	1320	1342	1366	1387	1403	1467	1505	1540	1639	1676	1760	1804	1843
72 (182.9)	1356	1339	1352	1370	1378	1401	1413	1431	1464	1478	1510	1527	1549	1575	1615	1659	1861	1907	1970	2008	2049
78 (198.2)	1452	1434	1448	1459	1469	1496	1510	1529	1561	1576	1607	1633	1659	1677	1729	1769	1980	2021	2090	2134	2177
84 (213.4)	1546	1527	1540	1554	1568	1592	1608	1631	1657	1680	1717	1741	1759	1782	1838	1879	2092	2144	2213	2258	2304
90 (228.6)	1555	1537	1549	1563	1578	1604	1629	1640	1677	1692	1729	1754	1777	1810	1861	1913	2120	2176	2248	2303	2352
96 (243.9)	1562	1543	1554	1569	1584	1619	1636	1661	1691	1714	1749	1774	1806	1829	1883	1941	2157	2207	2289	2341	2390
102 (259.1)	1568	1549	1568	1579	1598	1629	1647	1669	1702	1727	1772	1792	1825	1853	1913	1970	2189	2246	2321	2381	2442
108 (274.4)	1577	1558	1575	1592	1608	1636	1665	1684	1719	1747	1785	1815	1849	1874	1941	1999	2225	2278	2361	2424	2487
114 (289.6)	1586	1568	1579	1604	1620	1647	1675	1700	1741	1759	1810	1838	1869	1898	1962	2028	2251	2311	2405	2481	2558
120 (304.8)	1587	1569	1592	1614	1633	1665	1684	1717	1753	1777	1825	1853	1886	1923	1994	2053	2287	2356	2433	2501	2566
126 (320.1)	1595	1578	1604	1629	1640	1675	1703	1729	1763	1790	1843	1877	1913	1944	2019	2084	2317	2385	2470	2537	2599

Template service fee: \$25 (net price)

## Colors

Alabaster . . . . . 112	Flax . . . . . 541	Pitch Black . . . . . 033	<b>Premium Colors (10% Surcharge)</b>
Almond . . . . . 724	Forest Shadow . . . . . 087	Raw Umber . . . . . 006	
Almost White Gloss . . . 065	Granite . . . . . 044	Real Red . . . . . 085	
Aluminum . . . . . 034	Gray Dawn . . . . . 405	Rock Gray . . . . . 399	
Beige . . . . . 011	Gray Haze . . . . . 983	Silver . . . . . 737	
Birch White . . . . . 375	Greige . . . . . 122	Skyline . . . . . 680	
Black Satin . . . . . 233	Hunter Green . . . . . 154	Smokey Gray . . . . . 026	
Buff . . . . . 624	Ice . . . . . 778	Snowcap White . . . . . 386	
Burgundy . . . . . 653	Lamplight . . . . . 904	Stucco . . . . . 963	
Cameo . . . . . 607	Magnet . . . . . 648	Tender Taupe . . . . . 103	
Char Brown . . . . . 062	Matte White . . . . . 042	True Blue . . . . . 089	
Coconut . . . . . 630	Mercury . . . . . 771	True White . . . . . 544	
Creamy Beige . . . . . 670	Midnight Blue . . . . . 057	U.N. Gray . . . . . 095	
Crystal White . . . . . 629	Milk Chocolate . . . . . 060	Vanilla . . . . . 100	
Desert Sand . . . . . 625	Navajo White . . . . . 376	White Gloss . . . . . 005	
Fawn . . . . . 031	Parchment . . . . . 535	White Satin . . . . . 205	



# Price Charts

## Price Group J: Circles

To price, use larger number for width.

1" (2.6 cm) Slats .006 Gauge

Height up to inches (cm) ↓	Width up to inches (cm) →													
	12 (30.5)	23 (58.5)	26 (66.1)	29 (73.7)	32 (81.3)	36 (91.5)	40 (101.6)	44 (111.8)	48 (122.0)	52 (132.1)	57 (144.8)	62 (157.5)	67 (170.2)	72 (182.9)
42 (106.7)	\$752	734	796	860	927	1014	1102	1193	1287	1373	1486	1593	1703	1812
48 (122.0)	755	739	801	872	937	1029	1115	1203	1299	1389	1508	1615	1724	1834
54 (137.2)	762	745	813	878	942	1038	1126	1213	1313	1400	1525	1636	1744	1859
60 (152.4)	777	756	822	885	961	1051	1136	1227	1324	1419	1541	1652	1763	1873
66 (167.7)	780	761	827	905	970	1058	1150	1236	1342	1436	1556	1669	1778	1898
72 (182.9)	785	767	836	911	976	1073	1160	1255	1359	1449	1575	1686	1802	1922

1" (2.6 cm) Slats .008 Gauge

Height up to inches (cm) ↓	Width up to inches (cm) →													
	12 (30.5)	23 (58.5)	26 (66.1)	29 (73.7)	32 (81.3)	36 (91.5)	40 (101.6)	44 (111.8)	48 (122.0)	52 (132.1)	57 (144.8)	62 (157.5)	67 (170.2)	72 (182.9)
42 (106.7)	\$761	744	803	869	941	1026	1115	1206	1303	1389	1507	1612	1724	1834
48 (122.0)	764	747	810	885	948	1041	1131	1219	1316	1408	1527	1636	1747	1859
54 (137.2)	773	753	827	891	952	1053	1143	1229	1330	1419	1546	1661	1769	1883
60 (152.4)	788	769	834	898	975	1066	1152	1245	1343	1438	1564	1677	1791	1902
66 (167.7)	791	773	840	917	984	1076	1168	1256	1361	1458	1583	1696	1806	1928
72 (182.9)	797	779	851	924	990	1090	1178	1274	1381	1472	1602	1715	1832	1954

Template service fee: \$25 (net price)

## Colors

Alabaster . . . . .112	Flax . . . . .541	Pitch Black . . . . .033
Almond . . . . .724	Forest Shadow . . . . .087	Raw Umber . . . . .006
Almost White Gloss . . . . .065	Granite . . . . .044	Real Red . . . . .085
Aluminum . . . . .034	Gray Dawn . . . . .405	Rock Gray . . . . .399
Beige . . . . .011	Gray Haze . . . . .983	Silver . . . . .737
Birch White . . . . .375	Greige . . . . .122	Skyline . . . . .680
Black Satin . . . . .233	Hunter Green . . . . .154	Smokey Gray . . . . .026
Buff . . . . .624	Ice . . . . .778	Snowcap White . . . . .386
Burgundy . . . . .653	Lamplight . . . . .904	Stucco . . . . .963
Cameo . . . . .607	Magnet . . . . .648	Tender Taupe . . . . .103
Char Brown . . . . .062	Matte White . . . . .042	True Blue . . . . .089
Coconut . . . . .630	Mercury . . . . .771	True White . . . . .544
Creamy Beige . . . . .670	Midnight Blue . . . . .057	U.N. Gray . . . . .095
Crystal White . . . . .629	Milk Chocolate . . . . .060	Vanilla . . . . .100
Desert Sand . . . . .625	Navajo White . . . . .376	White Gloss . . . . .005
Fawn . . . . .031	Parchment . . . . .535	White Satin . . . . .205

### Premium Colors (10% Surcharge)

Alabaster Pearl . . . . .326
Ash Metallic . . . . .126
Beige Pearl . . . . .328
Brushed Aluminum . . . . .121
Fawn Pearl . . . . .327
Polished Aluminum . . . . .741
White Pearl . . . . .637

# Price Charts

## Price Group K: Side Cuts, Inverted Triangles, Angle Top and Bottom

### 1" (2.6 cm) Slats .006 Gauge

Height up to inches (cm) ↓	Width up to inches (cm) →																				
	12 (30.5)	23 (58.5)	26 (66.1)	29 (73.7)	32 (81.3)	36 (91.5)	40 (101.6)	44 (111.8)	48 (122.0)	52 (132.1)	57 (144.8)	62 (157.5)	67 (170.2)	72 (182.9)	82 (208.3)	92 (233.7)	102 (259.1)	112 (284.5)	122 (309.9)	132 (335.3)	142 (360.7)
42 (106.7)	\$446	428	430	439	448	499	508	522	531	580	599	609	624	685	715	739	856	877	908	1046	1066
48 (122.0)	448	430	439	449	458	511	522	534	544	596	618	629	643	705	739	768	883	908	942	1082	1110
54 (137.2)	456	439	449	458	463	522	534	544	556	607	633	651	663	730	758	796	911	942	976	1116	1150
60 (152.4)	469	449	458	463	480	534	544	559	567	624	651	668	685	747	784	813	942	976	1008	1153	1188
66 (167.7)	472	453	463	480	491	544	559	567	584	642	668	685	698	771	806	840	972	1004	1044	1194	1231
72 (182.9)	476	460	473	488	496	556	567	584	603	658	685	701	721	796	830	869	998	1039	1083	1231	1267
78 (198.2)	488	470	483	494	503	565	580	599	617	671	698	721	745	810	860	895	1030	1068	1116	1267	1309
84 (213.4)	501	480	491	503	516	579	594	613	627	687	721	744	761	830	883	920	1058	1105	1153	1304	1346
90 (228.6)	506	488	500	511	525	590	612	623	643	698	733	755	778	857	903	950	1083	1135	1188	1344	1391
96 (243.9)	511	494	503	518	531	603	620	639	658	719	751	773	803	872	922	976	1116	1162	1223	1381	1425
102 (259.1)	518	500	516	528	546	612	629	648	671	731	769	792	819	895	950	999	1145	1197	1255	1419	1472
108 (274.4)	525	507	522	537	555	620	643	662	685	748	784	810	842	916	976	1029	1177	1227	1288	1454	1512
114 (289.6)	533	516	528	551	564	629	653	677	703	761	806	831	861	937	995	1053	1202	1257	1327	1508	1579
120 (304.8)	534	518	537	559	575	643	662	690	716	778	819	845	875	961	1026	1079	1234	1296	1356	1526	1587
126 (320.1)	545	525	551	569	583	653	681	704	725	789	836	868	901	979	1044	1105	1262	1326	1386	1558	1618

### 1" (2.6 cm) Slats .008 Gauge

Height up to inches (cm) ↓	Width up to inches (cm) →																				
	12 (30.5)	23 (58.5)	26 (66.1)	29 (73.7)	32 (81.3)	36 (91.5)	40 (101.6)	44 (111.8)	48 (122.0)	52 (132.1)	57 (144.8)	62 (157.5)	67 (170.2)	72 (182.9)	82 (208.3)	92 (233.7)	102 (259.1)	112 (284.5)	122 (309.9)	132 (335.3)	142 (360.7)
42 (106.7)	\$453	437	440	447	461	508	522	537	547	596	617	627	643	705	739	763	885	913	942	1086	1105
48 (122.0)	458	440	447	463	470	525	537	551	560	614	637	651	668	730	763	798	916	942	980	1122	1153
54 (137.2)	467	447	463	470	474	537	551	560	574	624	658	675	687	755	789	827	947	980	1019	1162	1198
60 (152.4)	479	463	470	474	494	551	560	575	585	643	675	690	712	774	813	851	980	1019	1053	1203	1236
66 (167.7)	484	467	474	494	506	560	575	585	605	667	690	712	727	801	841	873	1014	1048	1096	1248	1287
72 (182.9)	490	472	486	503	510	574	585	605	624	679	712	730	751	827	866	911	1042	1088	1138	1287	1327
78 (198.2)	502	483	499	508	520	584	600	620	639	693	727	751	778	845	899	937	1079	1119	1174	1327	1373
84 (213.4)	511	494	506	520	534	599	617	636	651	716	751	774	796	866	922	966	1110	1160	1214	1370	1415
90 (228.6)	521	503	516	530	546	612	633	646	672	727	763	791	810	895	946	998	1138	1193	1250	1413	1465
96 (243.9)	526	508	520	536	551	624	642	668	685	748	786	807	842	914	969	1026	1174	1224	1288	1453	1502
102 (259.1)	533	516	534	547	564	633	657	676	698	762	805	829	860	937	998	1053	1205	1262	1324	1494	1555
108 (274.4)	544	524	541	559	575	642	672	689	716	783	819	851	884	961	1026	1083	1240	1296	1362	1535	1598
114 (289.6)	554	534	547	569	585	657	679	707	734	796	845	872	906	983	1046	1112	1267	1327	1406	1593	1670
120 (304.8)	555	536	559	580	600	672	689	724	748	810	860	887	921	1008	1081	1140	1303	1372	1436	1614	1679
126 (320.1)	563	546	569	594	609	679	712	738	758	826	877	914	948	1029	1102	1168	1335	1403	1469	1647	1712

Template service fee: \$25 (net price)

## Colors

Alabaster . . . . . 112	Flax . . . . . 541	Pitch Black . . . . . 033	<b>Premium Colors</b>
Almond . . . . . 724	Forest Shadow . . . . . 087	Raw Umber . . . . . 006	<b>(10% Surcharge)</b>
Almost White Gloss . . . 065	Granite . . . . . 044	Real Red . . . . . 085	Alabaster Pearl . . . . . 326
Aluminum . . . . . 034	Gray Dawn . . . . . 405	Rock Gray . . . . . 399	Ash Metallic . . . . . 126
Beige . . . . . 011	Gray Haze . . . . . 983	Silver . . . . . 737	Beige Pearl . . . . . 328
Birch White . . . . . 375	Greige . . . . . 122	Skyline . . . . . 680	Brushed Aluminum . . . . 121
Black Satin . . . . . 233	Hunter Green . . . . . 154	Smokey Gray . . . . . 026	Fawn Pearl . . . . . 327
Buff . . . . . 624	Ice . . . . . 778	Snowcap White . . . . . 386	Polished Aluminum . . . . 741
Burgundy . . . . . 653	Lamplight . . . . . 904	Stucco . . . . . 963	White Pearl . . . . . 637
Cameo . . . . . 607	Magnet . . . . . 648	Tender Taupe . . . . . 103	
Char Brown . . . . . 062	Matte White . . . . . 042	True Blue . . . . . 089	
Coconut . . . . . 630	Mercury . . . . . 771	True White . . . . . 544	
Creamy Beige . . . . . 670	Midnight Blue . . . . . 057	U.N. Gray . . . . . 095	
Crystal White . . . . . 629	Milk Chocolate . . . . . 060	Vanilla . . . . . 100	
Desert Sand . . . . . 625	Navajo White . . . . . 376	White Gloss . . . . . 005	
Fawn . . . . . 031	Parchment . . . . . 535	White Satin . . . . . 205	

# Price Charts

## Price Group L: Octagons, Triangles

### 1" (2.6 cm) Slats .006 Gauge

Height up to inches (cm) ↓	Width up to inches (cm) →																				
	12 (30.5)	23 (58.5)	26 (66.1)	29 (73.7)	32 (81.3)	36 (91.5)	40 (101.6)	44 (111.8)	48 (122.0)	52 (132.1)	57 (144.8)	62 (157.5)	67 (170.2)	72 (182.9)	82 (208.3)	92 (233.7)	102 (259.1)	112 (284.5)	122 (309.9)	132 (335.3)	142 (360.7)
42 (106.7)	\$556	537	541	548	560	628	639	653	662	730	748	756	774	873	905	927	1086	1110	1138	1287	1305
48 (122.0)	560	541	548	561	567	642	653	667	673	747	768	782	796	898	927	959	1112	1138	1172	1323	1348
54 (137.2)	565	548	561	567	572	653	667	673	686	755	786	801	811	920	950	984	1141	1172	1205	1357	1391
60 (152.4)	580	561	567	572	591	667	673	687	698	774	801	815	835	937	975	1005	1172	1205	1239	1394	1425
66 (167.7)	583	564	572	591	602	673	687	698	716	794	815	835	850	963	996	1029	1202	1234	1275	1435	1471
72 (182.9)	587	568	583	599	607	686	698	716	733	806	835	852	871	984	1021	1060	1229	1270	1314	1471	1508
78 (198.2)	597	580	593	605	613	694	710	729	747	819	850	871	895	1002	1051	1086	1260	1299	1347	1508	1548
84 (213.4)	610	591	602	613	627	707	725	744	755	840	871	892	913	1021	1073	1111	1288	1338	1385	1545	1587
90 (228.6)	617	599	610	623	636	720	743	752	774	850	884	908	926	1046	1091	1141	1314	1364	1416	1585	1632
96 (243.9)	623	605	613	628	641	733	749	769	788	868	903	922	952	1063	1114	1165	1347	1392	1453	1622	1666
102 (259.1)	628	610	627	637	657	743	758	782	800	883	920	942	970	1086	1141	1192	1376	1427	1483	1659	1714
108 (274.4)	636	618	632	646	667	749	774	792	813	899	931	963	991	1105	1165	1219	1408	1458	1520	1695	1753
114 (289.6)	644	627	637	661	675	758	784	807	834	913	957	981	1011	1126	1188	1243	1434	1486	1558	1748	1819
120 (304.8)	645	628	646	669	686	774	792	822	845	926	970	995	1028	1150	1217	1269	1465	1526	1587	1766	1826
126 (320.1)	655	636	661	681	692	784	810	835	856	938	985	1020	1051	1168	1235	1296	1494	1556	1618	1799	1859

### 1" (2.6 cm) Slats .008 Gauge

Height up to inches (cm) ↓	Width up to inches (cm) →																				
	12 (30.5)	23 (58.5)	26 (66.1)	29 (73.7)	32 (81.3)	36 (91.5)	40 (101.6)	44 (111.8)	48 (122.0)	52 (132.1)	57 (144.8)	62 (157.5)	67 (170.2)	72 (182.9)	82 (208.3)	92 (233.7)	102 (259.1)	112 (284.5)	122 (309.9)	132 (335.3)	142 (360.7)
42 (106.7)	\$564	547	551	559	569	639	653	669	676	747	767	778	796	898	927	956	1115	1143	1172	1326	1346
48 (122.0)	567	551	559	572	580	658	669	679	689	763	789	801	815	920	956	989	1145	1172	1211	1364	1394
54 (137.2)	576	559	572	580	584	669	679	689	704	774	806	826	840	947	979	1019	1177	1211	1248	1403	1439
60 (152.4)	591	572	580	584	605	679	689	705	717	796	826	842	861	966	1005	1039	1211	1248	1284	1443	1478
66 (167.7)	593	575	584	605	617	689	705	717	734	813	842	861	875	991	1030	1066	1243	1280	1326	1486	1527
72 (182.9)	599	581	596	613	622	704	717	734	753	830	861	878	903	1019	1057	1101	1274	1318	1366	1527	1568
78 (198.2)	612	593	609	620	629	716	730	749	769	845	875	903	926	1035	1088	1126	1310	1351	1404	1568	1614
84 (213.4)	623	605	617	629	643	729	747	767	783	865	903	924	946	1057	1114	1156	1340	1391	1443	1608	1656
90 (228.6)	631	613	627	639	657	743	763	779	801	875	916	941	963	1086	1136	1190	1366	1423	1479	1653	1703
96 (243.9)	637	620	629	645	661	753	773	797	813	899	935	959	991	1104	1159	1217	1404	1454	1520	1694	1744
102 (259.1)	644	627	643	658	675	763	786	806	829	914	956	979	1009	1126	1190	1243	1436	1494	1555	1734	1797
108 (274.4)	651	633	651	669	686	773	801	819	845	930	970	999	1034	1150	1217	1274	1471	1526	1593	1776	1838
114 (289.6)	662	643	658	681	694	786	809	840	865	946	995	1025	1056	1174	1236	1303	1498	1558	1636	1834	1912
120 (304.8)	664	645	669	689	710	801	819	854	877	963	1009	1037	1073	1198	1270	1328	1532	1602	1666	1854	1919
126 (320.1)	674	657	681	704	719	809	842	866	889	976	1029	1063	1100	1219	1293	1359	1564	1633	1699	1887	1951

Template service fee: \$25 (net price)

## Colors

Alabaster . . . . .	112	Flax . . . . .	541	Pitch Black . . . . .	033	<b>Premium Colors (10% Surcharge)</b>		
Almond . . . . .	724	Forest Shadow . . . . .	087	Raw Umber . . . . .	006		Alabaster Pearl . . . . .	326
Almost White Gloss . . . . .	065	Granite . . . . .	044	Real Red . . . . .	085		Ash Metallic . . . . .	126
Aluminum . . . . .	034	Gray Dawn . . . . .	405	Rock Gray . . . . .	399		Beige Pearl . . . . .	328
Beige . . . . .	011	Gray Haze . . . . .	983	Silver . . . . .	737		Brushed Aluminum . . . . .	121
Birch White . . . . .	375	Greige . . . . .	122	Skyline . . . . .	680		Fawn Pearl . . . . .	327
Black Satin . . . . .	233	Hunter Green . . . . .	154	Smokey Gray . . . . .	026		Polished Aluminum . . . . .	741
Buff . . . . .	624	Ice . . . . .	778	Snowcap White . . . . .	386		White Pearl . . . . .	637
Burgundy . . . . .	653	Lamplight . . . . .	904	Stucco . . . . .	963			
Cameo . . . . .	607	Magnet . . . . .	648	Tender Taupe . . . . .	103			
Char Brown . . . . .	062	Matte White . . . . .	042	True Blue . . . . .	089			
Coconut . . . . .	630	Mercury . . . . .	771	True White . . . . .	544			
Creamy Beige . . . . .	670	Midnight Blue . . . . .	057	U.N. Gray . . . . .	095			
Crystal White . . . . .	629	Milk Chocolate . . . . .	060	Vanilla . . . . .	100			
Desert Sand . . . . .	625	Navajo White . . . . .	376	White Gloss . . . . .	005			
Fawn . . . . .	031	Parchment . . . . .	535	White Satin . . . . .	205			

## Options Pricing

Options Pricing	
Options	Surcharge
Cloth Tapes (2" (5.1 cm) Grandeur™ only)	See price charts
Bay and Corner Window	No charge
Cut-outs	\$67
Double Slat	Double blind price
Hidden Holes	See surcharges with price charts
Hold Down Brackets	No charge
Inverted Slats	\$20
Limited Tilt	No charge
Motorization	See motorization price list for pricing, sizing, and accessory information
Multi-Colored Striped Blinds	Second color: \$25
	All additional colors: \$10
	Each additional blind of the same size and pattern on the same order: \$10
Multiple Blinds on One Headrail	See price charts
Premium Blind Colors	10% surcharge (add to base price)
Projection Brackets: 1¾" (4.5 cm), 2¾" (7.0 cm), 4¾" (12.1 cm)	No charge
Outside Mount Only	
Ring Pull/Ring Tilt	No charge
Shims ⅜" (0.5 cm)	No charge
Sky Poles	3 to 6½ feet (0.9 m to 2.0 m) \$46, 5 to 9½ feet (1.5 m to 2.9 m) \$70
Template Service	\$25 (net price)
Top Lock	No charge
Wood Cornices and Wood Valances	See cornices and valances price list for pricing information

# GRABER®

Grabber is a brand of Springs Window Fashions, the Best Experience Company 

Grabber and the Grabber logo are registered trademarks of Springs Window Fashions, LLC.

19-0750-02 (02/19) 18-10492|S18-9785