

TRADITIONS® WOOD SHUTTERS

Table of Contents

Features	
The Graber Wood Story	2
Wood Characteristics	3
Options and Size Considerations	
Shutter Styles	4-5
Product Illustration, Panel Detail	6
Louver Options	7
Tilt Options: Hide-a-Tilt™, Tilt Options: Split Tilt, Panel Overlap Styles	8
Double Mouse Hole, Hinge Colors	9
Shutter Color Options, Additional Color Information, Custom Color, Custom Color Match Process	10
Wood: Panel Configurations—Standard, Arch, Angle Top Shutters	11
Wood: Minimum and Maximum Width by Panel Configuration: 2½" (6.4 cm), 3½" (8.9 cm), and 4½" (11.5 cm) Louvers	12
Wood: Minimum and Maximum Height by Frame Type	13
Frame Type Decision Tree	14
Measuring for Standard Shutters	15
Measuring Divider Rail Location, Divider Rail Requirements, Measuring T-Post Locations	16
Proper Application of the Tilt-Out Z-Frame, Sill Cap Application	17
Wood Frame Product Detail	18-20
Specifications	
Deductions for Frame Allowances, Installation Hardware	21
Frame Configurations	22
Specialty Styles	
Café Shutters	23
Sunburst Arch without Frame	24
Sunburst Arch with Frame	25
How to Make a Template	26
Framed Arch Installation Option, Frameless Arch Installation Option	27
Arch and Angle Top Panel Shutters, Measuring Leg Height and Divider Rail Height	28
Measuring Leg Height and Divider Rail Height for Frame-to-Frame Measurement	28
Arch and Angle Top Panel Shutters: Minimum/Maximum Height	29
French Door Shutters, French Door Shutters: Minimum/Maximum French Door Sizes	29
French Door Shutters Cut-Out Options	30
French Door Shutters: Placement of L-Frame, French Door Shutters: Recessed Back Plate	31
Bypass Shutters, Valance Options, Bypass Shutters: Mounting Options	32-33
Bypass Track System Configuration Options: Only Configurations Available	34
Bypass Shutter: Minimum/Maximum Width Order Size by Panel Configuration	34
Bypass Track System, Custom Header	35
Bifold Track System, Bifold Mounting Options	36
Bifold Track System: Minimum/Maximum Width by Panel Configuration, Bifold Track System: Stack Back, Valance Options	37
Side Light	38
Bay Windows	39-40
Corner Windows	41-42
General Information	
Definitions	43
Care Instructions	44
Price Charts and Options Pricing	
Wood Shutter Pricing, Wood Specialty Surcharges	45



Features

The Graber® Wood Story

Quality of Wood Defines a Shutter's Quality

We use only 100% North American hardwood in the construction of our wood shutters because of its light weight, consistent color, hardness, structural stability, and attractive grain.

Sound Forestry Techniques

We work only with foresters who practice sustainable forest management. Nearly twice as much hardwood grows as is harvested in the U.S. each year. The volume of hardwoods in American forests today is 90% larger than it was 50 years ago.

Preserving Our Natural Resources

Our Springs Window Fashions (SWF) wood facility in Grayling, Michigan, consumes recycled sawdust and wood shavings, generating the heat required to dry lumber, for a completely self-sufficient manufacturing process. Our Reynosa, Mexico, fabrication and finishing facility is 99.7% pollution-free, above any U.S. standard.

SWF Wood Facility in Grayling, Michigan

We have control over the quality of wood used—we control the process from green lumber to finished shutters. Hardwoods used in crafting Graber wood shutters are kiln-dried and molded at our SWF Wood facility. The wood is dried slowly to strict wood shutter specifications because structural change can occur when moisture is removed. Molding and sanding operations provide the highest quality surface, free of defects.

SWF Wood Fabrication and Finishing in Reynosa, Mexico

At our state-of-the-art finishing plant in Reynosa, Mexico, components are carefully sorted prior to fabrication for color uniformity and wood characteristics. We sort wood as an end user, rather than as a finishing vendor, taking out defects in a climate-controlled building. Each shutter is handmade by craftsmen to your client's custom needs. To finish the shutter, we use only high quality paints and stains; on-site certified color technicians provide both application and quality control.

What Makes Graber Shutters Different From the Rest?

- Wood shutters are made from 100% North American hardwoods, the premier wood used in the construction of shutters
- SWF wood facilities provide state-of-the-art technologies and processes
- Expanded finish choices with unique staining process that showcases the natural grain of the wood
- An outstanding selection of styles, louvers (including 4½" (11.5 cm) size), frames and arches
- The best customer service team in the industry—trained to answer any questions about Graber shutters
- Limited lifetime warranty

Features

Wood Characteristics

Wood used to manufacture wood shutters has many natural characteristics that make it truly unique; no two pieces of hardwood are alike. The following are all natural characteristics of wood, and we do not consider them to be defects:

- Grain—The direction, size, and appearance of wood fibers vary greatly depending on where the wood is cut within the tree
- Tiger Striping—Directional change in grain pattern
- Burl—Formed from an irregular growth on the outer edge of the tree
- Bird's Eye—Small area on the surface of the board where fibers are contorted to form circular figures that resemble birds' eyes
- Knots—Vary in size, shape, structure, and color (only solid knots less than $\frac{3}{8}$ " (1 cm) diameter are allowed)
- Mineral Marks—Dark or discolored areas caused by minerals which the tree extracts from the soil, they can be either streaks or stains, usually blackish blue

Natural variations in color and grain effect are inherent in the beauty of wood. These variations are within established industry guidelines and should be expected. In addition, shutters may stain slightly darker or lighter than the samples shown.



Options

Shutter Styles

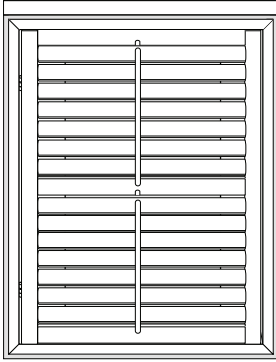

Standard Panel: A rectangular-shaped panel that can be installed using any frame style. Panel covers the entire window opening.

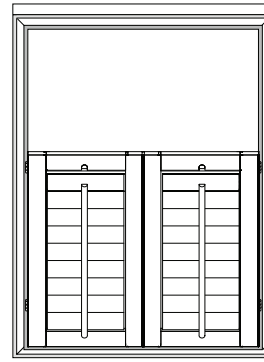

Café: Classic style covers the bottom part of the window, allowing light to enter while protecting your privacy. A good choice for bedrooms.



Bypass Track System: Shutter panels slide on a double top track to open and close. The track system can be attached to a frame or mounted directly to a window casing or the ceiling. Ideal for patios or closet doors. Louvers must be closed to pass.

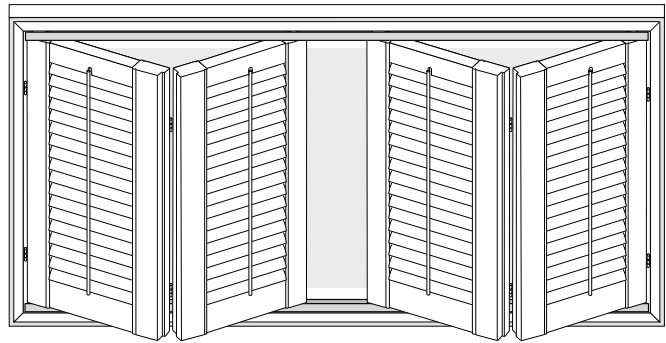

Bifold Track System: Two, four, or eight panels are hinged together with a top and bottom track. Popular for large windows, patio doors, or sliding glass doors.

NOTE: Remember that shutters do not block all light from entering the room. All shutters have moving parts. These parts have tolerance gaps that will allow some light to filter through the shutter.

Options

Shutter Styles

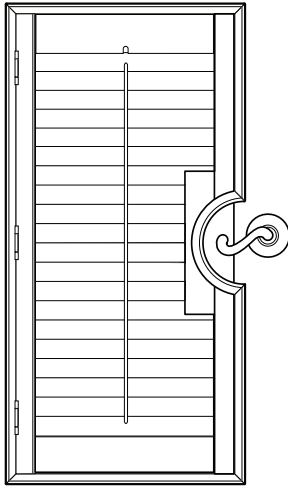

French Doors: Add the beauty of shutters to French doors. Curved or rectangular cutout options complement contemporary door handles or traditional door knobs.

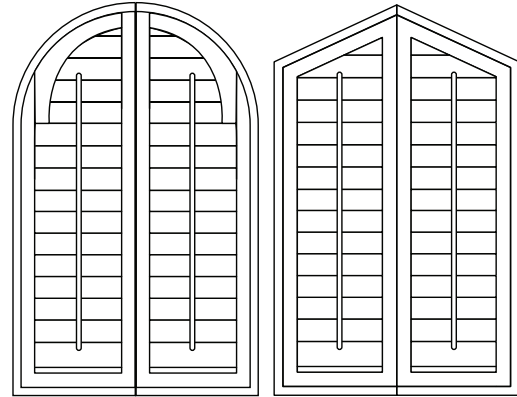

Arch or Angle Top Panels: Provide whole window solutions that fit the rounded shape of full arch windows perfectly. Angled panels accommodate slanted windows. Available in full arch or angle, $\frac{1}{4}$ arch, or $\frac{1}{2}$ angle.

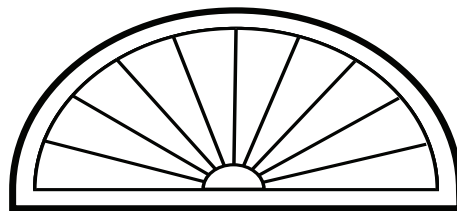

Sunburst Arches: Sunburst patterned louvers cover unique window silhouettes such as eyebrow, elongated, palladian, and elliptical arches. Also available as $\frac{1}{4}$ arches.

Options

Product Illustration

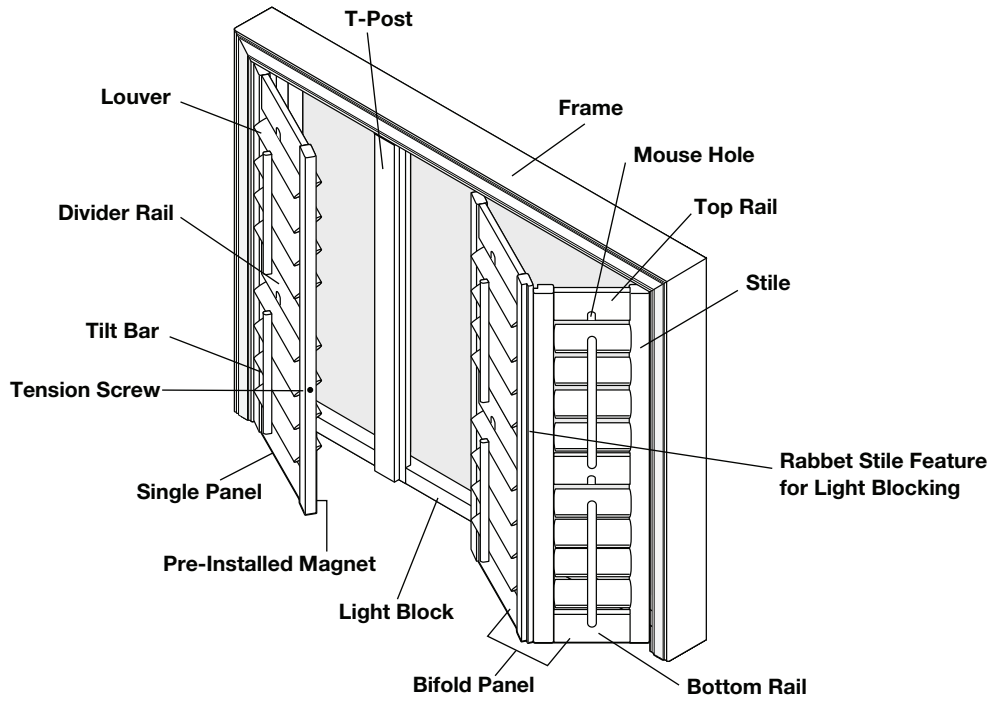

Panel Detail

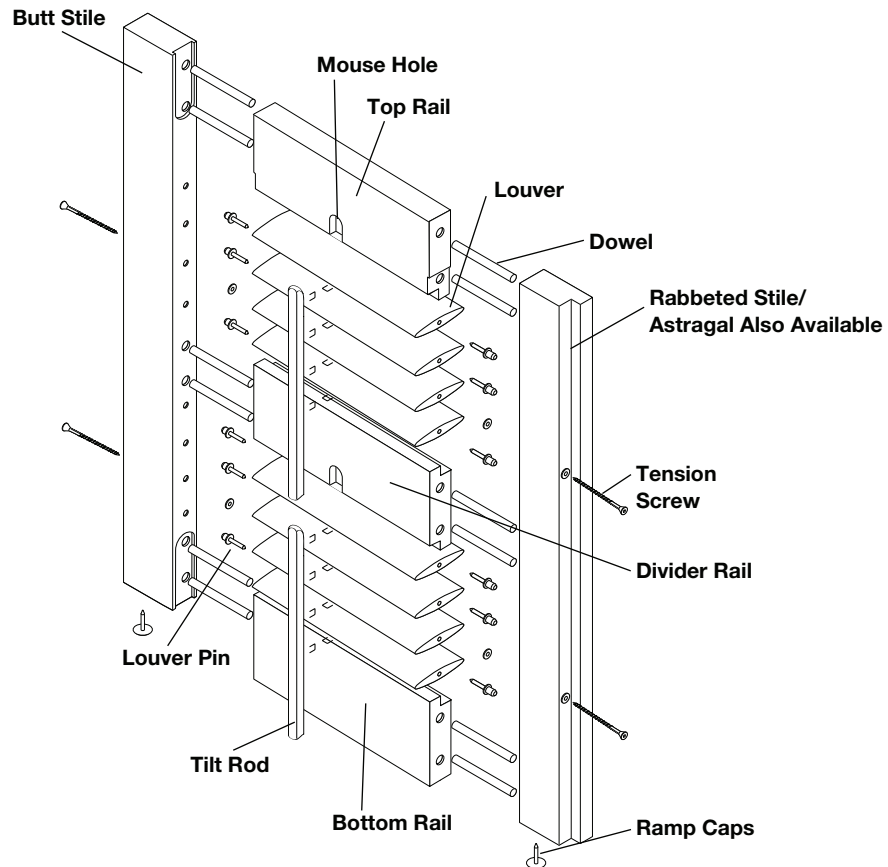

Options

Louver Options

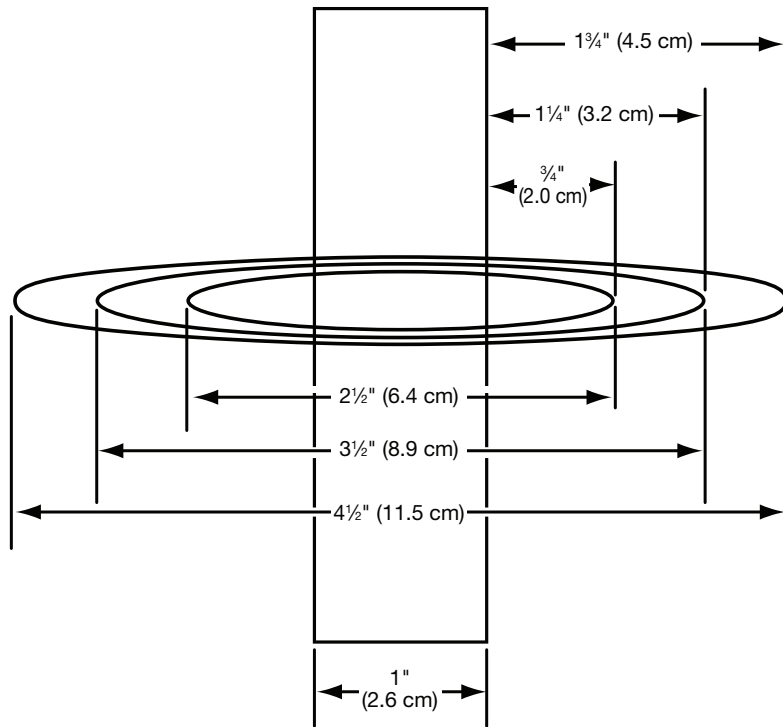

Minimum Clearance Needed From Back Panel Surface		
Louver Size inches (cm)	Standard Tilt inches (cm)	Hide-a-Tilt™ inches (cm)
2½ (6.4)	¾ (2.0)	1½ (2.9)
3½ (8.9)	1¼ (3.2)	1¾ (4.2)
4½ (11.5)	1¾ (4.5)	2½ (5.4)

NOTE: Hide-a-Tilt requires an additional ⅝" (1.0 cm) window clearance

2½" (6.4 cm) Louver

- Traditional in style
- Minimal window depth needed
- Shutters are focal point of the room

3½" (8.9 cm) Louver

- Most popular louver size
- Offers more visibility and light control

4½" (11.5 cm) Louver

- Provides the greatest visibility through the open louvers
- Looks most proportionate in a larger window, view beyond the window becomes more important
- Louvers almost disappear when open

Wood Louver Sizes

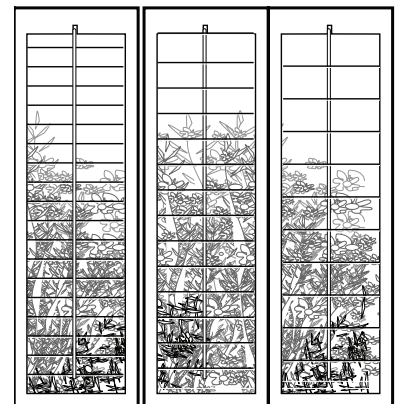

2½" (6.4 cm) 3½" (8.9 cm) 4½" (11.5 cm)

Options

Tilt Options: Hide-A-Tilt™

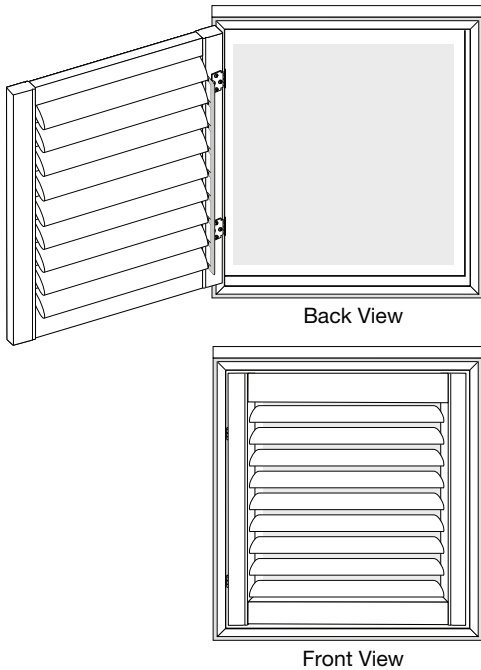

Hide-a-Tilt Option offers the tilt mechanism in the back of the shutter panel, eliminating the traditional tilt bar and creating an unobstructed view, as well as a clean linear appearance. A thin stainless steel tilt bar is attached to the louvers in the rear of the panel. Operation of the shutter is as simple as positioning one louver into position; all of the other louvers will follow.

- Hide-a-Tilt bar will always be stainless steel color
- Hide-a-Tilt is mounted on hinge side for standard shutters
- No mouse hole in the panel
- Hide-a-Tilt allows the shutter to be closed in the upward or downward position
- Ordered heights over 60" (152.4 cm) will require split tilt

Tilt Options: Split Tilt

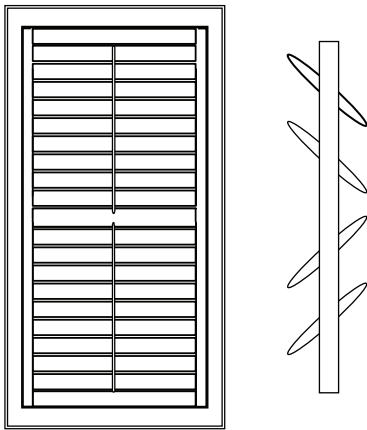

Split Tilt

No divider rail. Splits one large louver set into two individually operated louver sets by cutting the tilt bar.

- Split tilt is available for all louver sizes with Hide-a-Tilt; it is not available on 2½" (6.4 cm) louvers with standard tilt (the front tilt will not allow the louvers to function properly)
- 2½" (6.4 cm) and 3½" (8.9 cm) louvers—split will be specified as exact
- 4½" (11.5 cm) louvers—split may shift up or down to +/- 2" (5.1 cm)

Consideration: Upper and lower louvers cannot be positioned at opposing angles because the edges of the louvers will touch.

NOTE: Top and bottom rails may vary or be unequal due to requested locations and louver spacing. Rail sizes vary from 3" (7.7 cm)-6" (15.3 cm).

Panel Overlap Styles

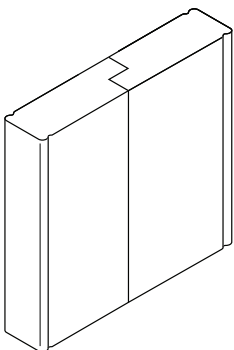

Rabbet Style Panel Overlap

- Factory standard
- Right over left overlap only
- Left over right overlap not available

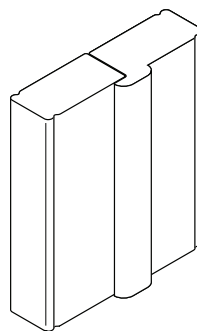

Astragal Style Panel Overlap

- No charge option
- Right over left overlap standard
- Left over right overlap optional
- Astragal will automatically be used between center and bifold panels

Options

Double Mouse Hole

Double Mouse Hole for Wood Shutters (single mouse hole is standard)

- A mouse hole on the rail above and below each louver section which allows the louvers to be closed in the upward or downward position

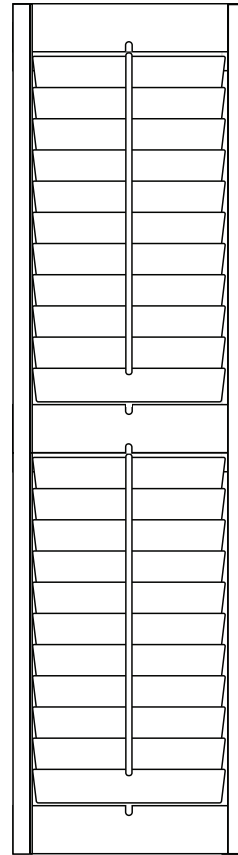
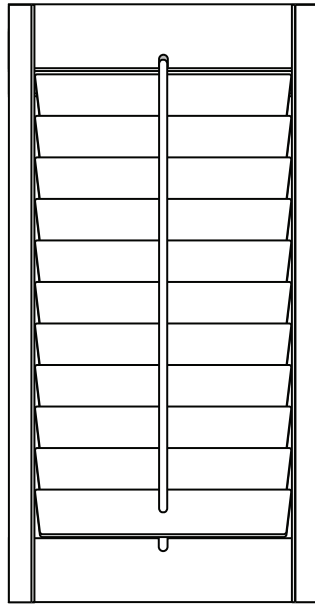

NOTE: Shutters will have tighter closure in the upward position.

Hinge Colors

Select the hardware color that best fits your decor:

- Antique Brass
- Off White
- Oil Rubbed Bronze
- Satin Nickel
- Stainless Steel*
- White

*5% surcharge

Options

Shutter Color Options

Wood: Paints	Color #
Almond	1724
Angora	1052
Antique White	1026
Base Black	1767
Base White*	1051
Bone	1024
Creamy White**	2729
Crisp White	1712
Designer White	1055
Dover White	1683
Ivory	1325
Manatee	1765
Overcast	1764
Putty	1410
Silk White	1922
Silk White**	2922
Snow White	1909
Snowflake	1603
Stark White	1869
Stucco	1963
Swiss Coffee	1692
Vanilla	1100
Competitive Paint	COMP
Custom Paint	CUSP

Wood: Stains	Color #
Cappuccino	1546
Cherry Wood	1014
Cognac	1465
Colonial Oak	1911
Dark Cherry	1316
Dark Walnut	1641
Espresso	1716
Golden Oak	1030
Harbor Grey	1761
Henna	1949
Homestead Oak	1943
Honey Maple	1013
Horseshoe	1760
Knotty Pine	1515
Light Pecan	1020
Natural	1007
Peru	1688
Pickled White	1762
Raven	1919
Saddle Brown	1694
Sienna	1685
Truffle	1054
Walnut	1012
Wheat	1710
Competitive Stain	COMS
Custom Stain	CUSS

*Wood color and composite color match

**Composite color match

NOTE: Wood Silk White 1922 and composite Silk White 2922 are different colors.

Additional Color Information

Due to the nature of manufacturing, colors may vary slightly between dye lots. Please order all shutters for the same room at the same time. Slight variations may also occur between the finished products and the color samples (see the wood characteristics section).

All standard colors in Traditions® 2" (5.1 cm) wood blind collection are available with no additional surcharge. Does not include unique finishes or Traditions Elite colors.

Custom Color

Choosing an appropriate color is critical to pulling a room's style together. With our unique custom color matching, your clients will never have to compromise on color again! We will even color match a competitor's color at no charge.

Just provide a color swatch or sample of the color you want to match—woodwork, wall coverings, paint, fabric—and our expert color technicians will provide an exact color match.

NOTE: See custom color form for colors that do not require a sample to be submitted.

Custom Color Match Process

1. Complete the custom color match request form.
2. Supply Springs Window Fashions with a color sample. For best results, submit a 3" x 3" (7.7 cm x 7.7 cm) color sample.
3. Send the form and the sample to:
Springs Window Fashions
8467 Route 405 South
P.O. Box 500
Montgomery, PA 17752
Attn: Shutter Department
4. Strike-off approval is required for all shutter orders.
5. Strike-offs will be sent for approval within 10-14 days of receiving the color sample.
6. Once color approval is received, fabrication of the custom shutters will begin. Leadtime begins once color is approved.

Options

Wood: Panel Configurations—Standard, Arch, and Angle Top Shutters

Panel Configurations Must be Selected from this Chart

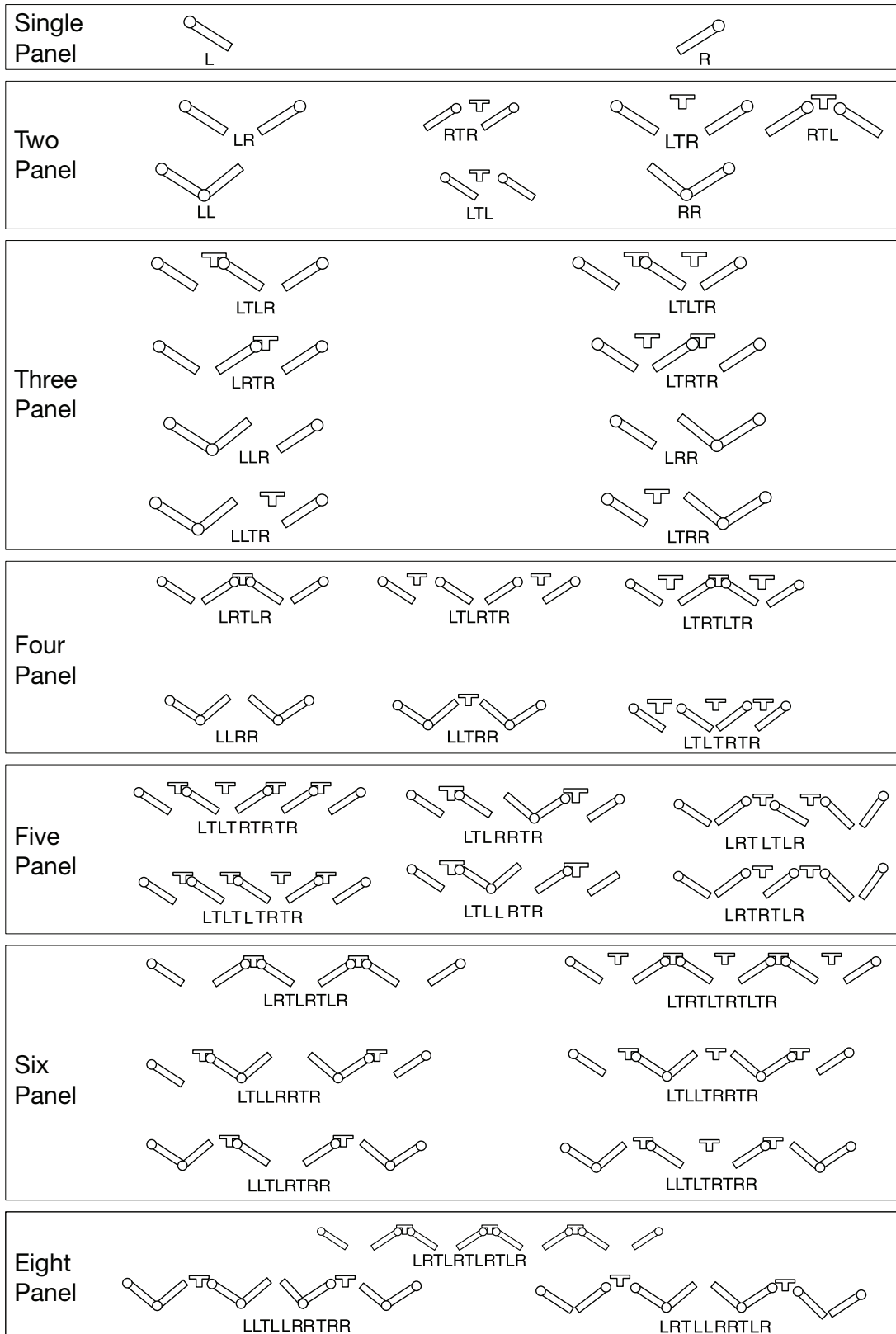

Size Considerations

Wood: Minimum and Maximum Height by Frame Type

Frame Configuration	Frame Type	Minimum		Maximum
		2½" (6.4 cm), 3½" (6.4 cm) Louvers inches (cm)	4½" (11.5 cm) Louvers inches (cm)	All Louvers inches (cm)
2-Sided	Hang strip/direct mount	15¼ (38.8)	20¼ (51.5)	120¼ (305.5)
2-Sided	Z-frame (except tilt-out)	15¼ (38.8)	20¼ (51.5)	120¼ (305.5)
3-Sided and 3-Sided Inverted	Z-frame (except tilt-out)	16⅞ (41.0)	21⅞ (53.7)	121⅞ (307.7)
3-Sided Sill Top or Bottom	Z-frame (except tilt-out)	16½ (42.0)	21½ (54.7)	121½ (308.7)
4-Sided Sill Top or Bottom	Z-frame (except tilt-out)	16⅞ (41.0)	21⅞ (53.7)	121⅞ (307.7)
4-Sided Sill Top and Bottom	Z-frame (except tilt-out)	16 (40.7)	21 (53.4)	121 (307.4)
4-Sided	Z-frame (except tilt-out)	17⅞ (43.4)	22⅞ (56.1)	122⅞ (310.1)
2-Sided	Tilt-out Z-frame	15¼ (38.8)	20¼ (51.5)	120¼ (305.5)
3-Sided and 3-Sided Inverted	Tilt-out Z-frame	15⅝ (40.5)	20⅝ (53.2)	120⅝ (307.2)
3-Sided Sill Top or Bottom	Tilt-out Z-frame	16⅞ (41.5)	21⅞ (54.2)	121⅞ (308.2)
4-Sided Sill Top or Bottom	Tilt-out Z-frame	15⅝ (39.6)	20⅝ (52.3)	120⅝ (306.3)
4-Sided Sill Top and Bottom	Tilt-out Z-frame	16 (40.7)	21 (53.4)	121 (307.4)
4-Sided	Tilt-out Z-frame	16⅞ (42.1)	21⅞ (54.8)	121⅞ (308.8)
2-Sided	L-frame (except narrow colonial L-frame)	15¼ (38.8)	20¼ (51.5)	120¼ (305.5)
3-Sided and 3-Sided Inverted	L-frame (except narrow colonial L-frame)	16¼ (41.3)	21¼ (54.0)	121¼ (308.0)
3-Sided Sill Top or Bottom	L-frame (except narrow colonial L-frame)	16⅞ (42.3)	21⅞ (55.0)	121⅞ (309.0)
4-Sided Sill Top or Bottom	L-frame (except narrow colonial L-frame)	16¼ (42.6)	21¼ (55.3)	121¼ (309.3)
4-Sided Sill Top and Bottom	L-frame (except narrow colonial L-frame)	16 (40.7)	21 (53.4)	121 (307.4)
4-Sided	L-frame (except narrow colonial L-frame)	17¼ (43.9)	22¼ (56.6)	122¼ (310.6)
2-Sided	Narrow colonial L-frame	15¼ (38.8)	20¼ (51.5)	120¼ (305.5)
3-Sided and 3-Sided Inverted	Narrow colonial L-frame	16 (40.7)	21 (53.4)	121 (307.4)
3-Sided Sill Top or Bottom	Narrow colonial L-frame	16⅞ (42.3)	21⅞ (55.0)	121⅞ (309.0)
4-Sided Sill Top or Bottom	Narrow colonial L-frame	16½ (42.0)	21½ (54.7)	121½ (308.7)
4-Sided Sill Top and Bottom	Narrow colonial L-frame	16 (40.7)	21 (53.4)	121 (307.4)
4-Sided	Narrow colonial L-frame	16¾ (42.6)	21¾ (55.3)	121¾ (309.3)
2-Sided	3.5" (8.9 cm) deco frame (curved, beaded, and craftsman)	15¼ (38.8)	20¼ (51.5)	120¼ (305.5)
3-Sided and 3-Sided Inverted	3.5" (8.9 cm) deco frame (curved, beaded, and craftsman)	18⅞ (46.1)	23⅞ (58.8)	123⅞ (312.8)
3-Sided Sill Top or Bottom	3.5" (8.9 cm) deco frame (curved, beaded, and craftsman)	15⅞ (39.7)	20⅞ (52.4)	120⅞ (306.4)
4-Sided Sill Top or Bottom	3.5" (8.9 cm) deco frame (curved, beaded, and craftsman)	18½ (47.0)	23½ (59.7)	123½ (313.7)
4-Sided Sill Top and Bottom	3.5" (8.9 cm) deco frame (curved, beaded, and craftsman)	16 (40.7)	21 (53.4)	121 (307.4)
4-Sided	3.5" (8.9 cm) deco frame (curved, beaded, and craftsman)	21 (53.4)	26 (66.1)	126 (320.1)
2-Sided	3" (7.7 cm) traditional deco frame	15¼ (38.8)	20¼ (51.5)	120¼ (305.5)
3-Sided and 3-Sided Inverted	3" (7.7 cm) traditional deco frame	17⅞ (44.7)	22⅞ (57.4)	122⅞ (311.4)
3-Sided Sill Top or Bottom	3" (7.7 cm) traditional deco frame	15⅞ (39.7)	20⅞ (52.4)	120⅞ (306.4)
4-Sided Sill Top or Bottom	3" (7.7 cm) traditional deco frame	17⅞ (45.6)	22⅞ (58.3)	122⅞ (312.3)
4-Sided Sill Top and Bottom	3" (7.7 cm) traditional deco frame	16 (40.7)	21 (53.4)	121 (307.4)
4-Sided	3" (7.7 cm) traditional deco frame	19⅞ (50.5)	24⅞ (63.2)	124⅞ (317.2)
4-Sided	Sidelight	16¼ (41.3)	N/A	97¼ (247.1)

Options

Frame Type Decision Tree

Review window and the area around the window. Choose from the options below.

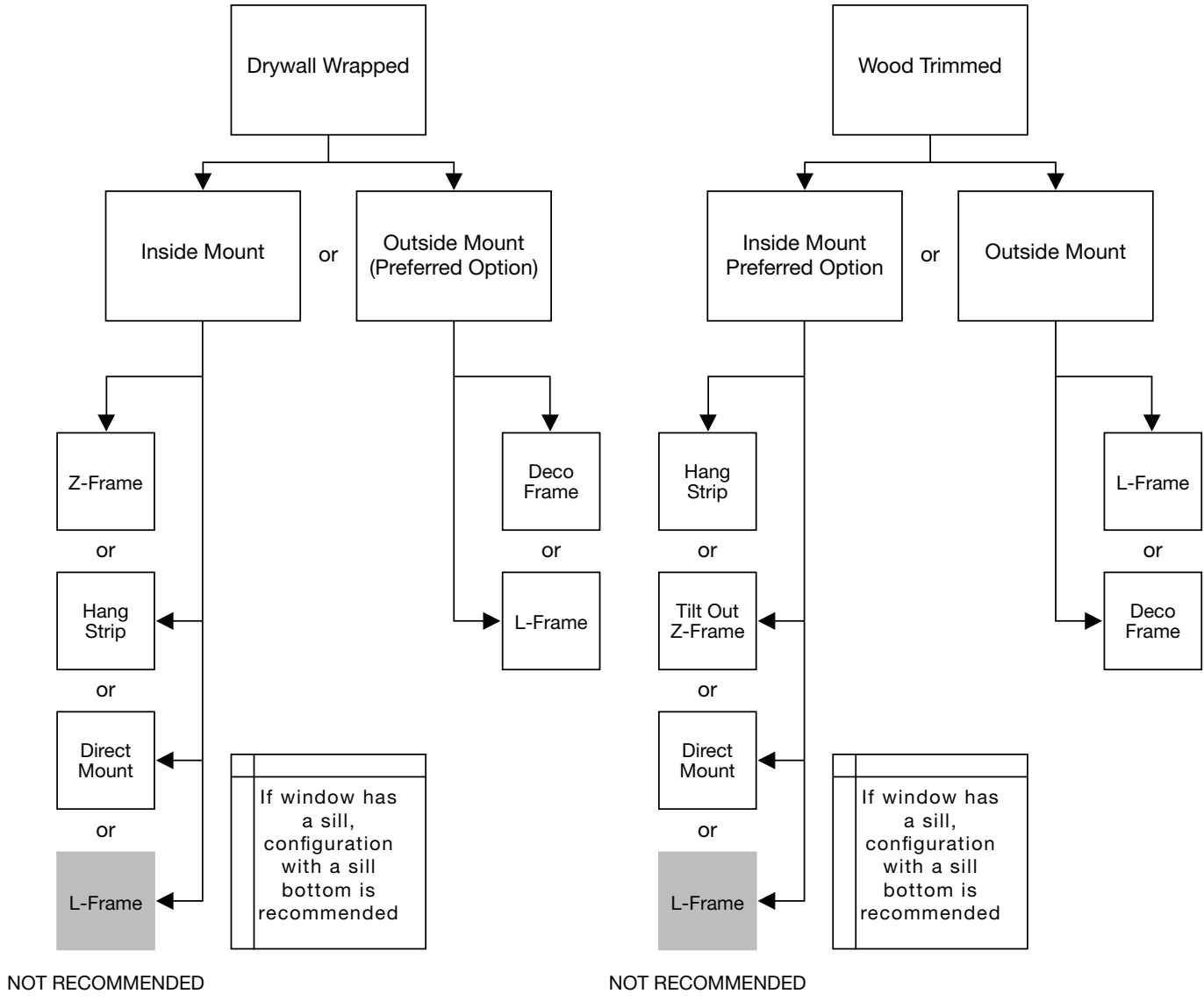

Options

Measuring for Standard Shutters

Confirm that the window is square.

Measure the diagonals. If the difference between the two measurements is greater than $\frac{1}{4}$ " (0.7 cm), an outside mount shutter is required.

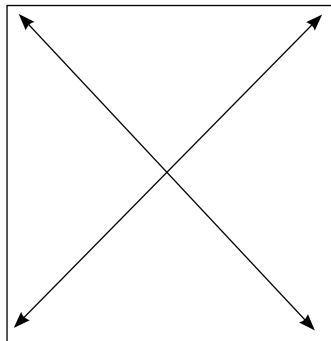

Square

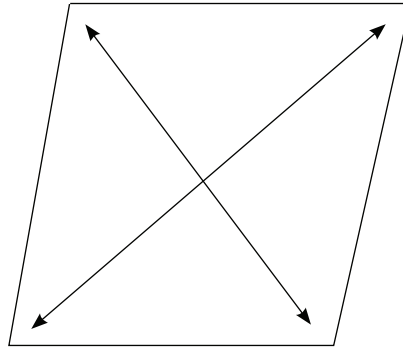

Not Square

Window Opening Measurement

Inside Mount with Hang Strips, Direct Mount, Z-Frame, Tilt-Out Z-Frame

- Measure the width at three points and the height at three points; use the smallest width and height measurements

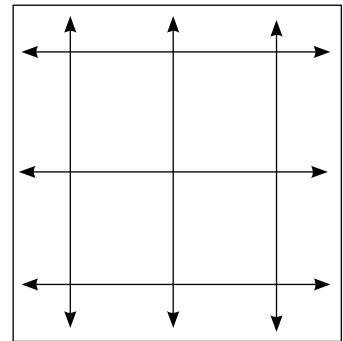

NOTE: Factory makes no allowances/deductions for tilt-out Z-frame.

Frame-to-Frame Measurement

Required for L-Frame and Deco Frame

- Place a sample of the L-frame or deco frame on the window frame or wall to determine frame-to-frame placement
- Measure frame-to-frame width at three points and frame-to-frame height at three points; use the largest width and height measurements

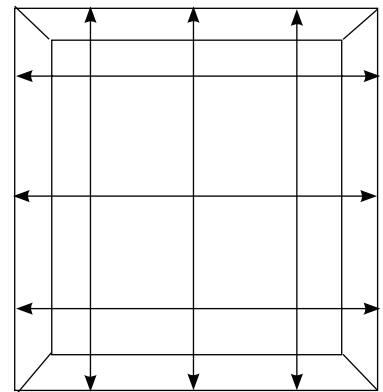

NOTE: At least $1\frac{1}{8}$ " (4.2 cm) flat surface is needed on each side of the window for an L-frame.

HELPFUL HINT: If shutters are in the same room and/or side by side, shutters must be ordered at the same height to ensure rail height, divider rail location, louver count, and hinge quantity will match.

NOTE: See corner post or bay post section for measuring instructions.

Options

Measuring Divider Rail Location

To measure frame-to-frame, measure from the bottom of the shutter frame up to the center of the desired rail or split tilt location.

To measure window opening, measure from the sill or bottom of the window opening to the center of the desired rail or split tilt location.

If there are two divider rails, measure from the bottom of measure type up to center of first rail location, then measure from the bottom of measure type up to the center of the second rail location.

Split tilt is only available in one location.

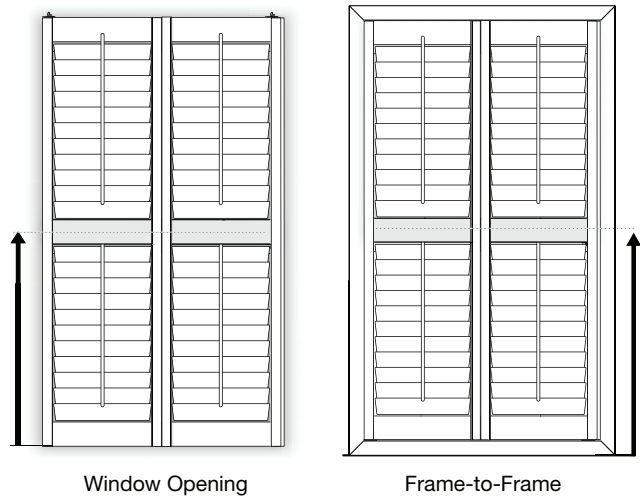

NOTE: Top and bottom rails may be unequal due to requested location and louver spacing. Rail sizes vary from 3" (7.7 cm)-6" (15.3 cm).

Divider Rail Requirements

1. Divider rails are required over 84" (213.4 cm) height for added strength.
2. Divider rail can be requested (when not required) for design purposes.
3. A 3" (7.7 cm) divider rail is used with 2½" (6.4 cm) and 3½" (8.9 cm) louvers.
4. A 4" (10.2 cm) divider rail is used with 4½" (11.5 cm) louvers.
5. Divider rails for 2½" (6.4 cm) and 3½" (8.9 cm) louvers will be as specified on order.
6. Factory may shift rail up or down, (+/- 2" (5.1 cm)) to achieve uniform louver spacing in 4½" (11.5 cm) louvers only.
7. Minimum louver set is 2 louvers in each section.
8. Two divider rails available but not required.

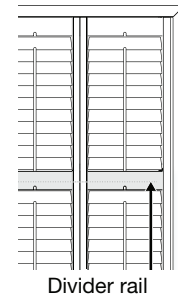

HELPFUL HINT: If shutters are in the same room and/or side by side, shutters must be ordered at the same height to ensure divider rail location will match. Top and bottom rail sizes may vary; and/or be unequal, due to requested location and louver spacing. Rail size vary from 3" (7.7 cm) to 6" (15.3 cm).

Measuring T-Post Locations

Always start from the left point of measure type to the center of the desired T-post location.

To measure frame-to-frame, measure from the left of the shutter frame to the center of the desired T-post location.

To measure the window opening, measure from the left inside of the window opening to the center of the desired T-post location.

If there is more than one T-post, measure from the left of measure type to the center of first T-post location, then measure from the left of measure type over to the center of the second T-post location etc.

EXAMPLE: A-B, A-C, A-D

Always measure from the same point the frame was measured.

EXAMPLE: If measuring for L-frame, frame-to-frame measure type, A is the outside edge of the L-frame.

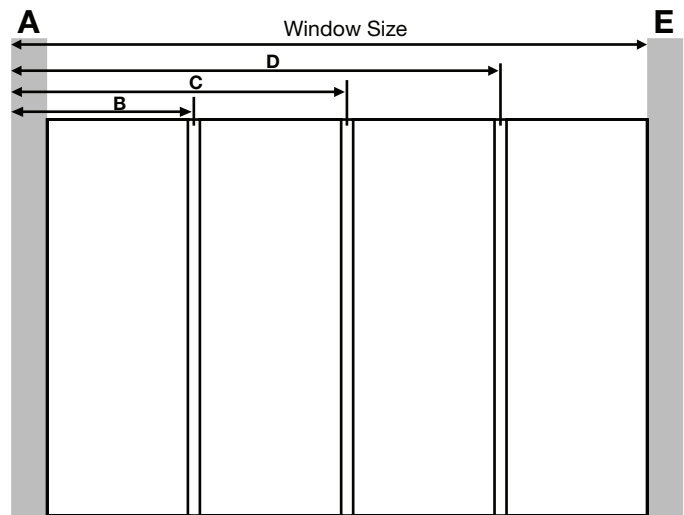

Options

Proper Application of the Tilt-Out Z-Frame

Tilt-Out Z-Frame (Inside Mount)

Designed to be used with certain styles of window trim. Panel and frame are pre-hinged. Frame is not pre-drilled. Shipment includes self-tapping "trim-head" screws.

Tilt-out Z-frame must be ordered as "Window Opening" (WO) size. NO factory deduction is made with this frame.

Factory Deductions: Width: 0" (0 cm)
Height: 0" (0 cm)

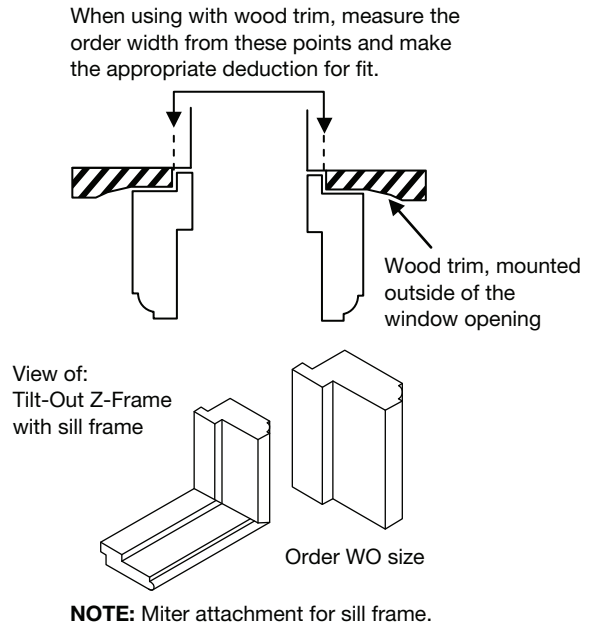

NOTE: Installer must make own deductions for proper fit. If diagonal measurements exceed $\frac{1}{8}$ " (0.4 cm) out of square, use other outside mount frame style.

Sill Cap Application

Ordering options:

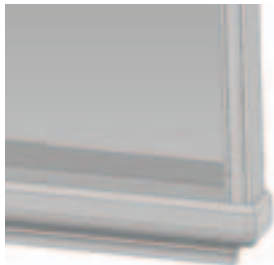

Flush with Frame

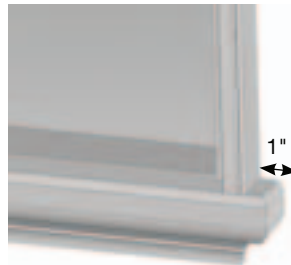

1" (2.6 cm) Overlap

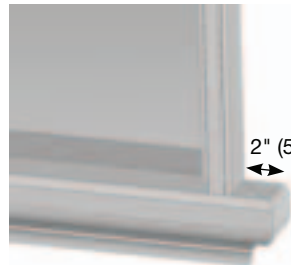

2" (5.1 cm) Overlap



Specified Length

3 Available Frame Configuration Options:

- 4-sided with sill cap bottom
- 3-sided invert with sill cap bottom
- 4-sided with sill frame top and sill cap bottom

Existing sill length on window will be required when ordering. This is to assure that sill cap option ordered will fit over the top of your existing window sill. A $1\frac{1}{8}$ " x $\frac{1}{2}$ " (4.2 cm x 1.3 cm) buildout will be provided to take up the gap between the existing sill and any inside mount frame. This buildout will be butted up to the back edge of the sill cap to extend the length.

The sill cap will sit flush against the wall for window sills protruding up to $1\frac{1}{4}$ " (3.2 cm) from the face of the wall. The sill cap can be used on longer sills but there will be a gap between the wall and the sill cap.

NOTE: No mounting hardware included. Adhesive should be used to attach sill cap to window sill.

Options

Wood Frame Product Detail

Direct Mount

- Inside mount only
- Window opening measure only
- Panel is pre-hinged
- Four light blocks included
- Factory automatically makes deductions: width— $\frac{3}{16}$ " (0.5 cm), height— $\frac{1}{4}$ " (0.7 cm)

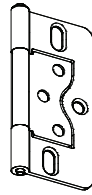

Frame Hinge

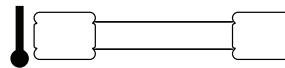

Example: 1-Panel L

Hang Strip

- Inside mount only
- Window opening measure
- Includes adjustable wrap-around hinge for easy installation
- Panel and hang strip are pre-hinged
- Hang strip is pre-drilled
- Top and bottom light blocks included
- Factory automatically makes deductions: width— $\frac{3}{16}$ " (0.5 cm), height— $\frac{1}{4}$ " (0.7 cm)

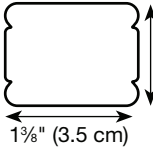
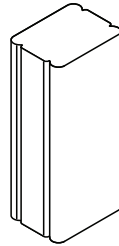

Hang Strip

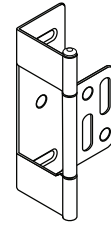

Hang Strip Hinge

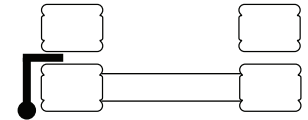

Example: 1-Panel L

Z-Frames

- Inside mount only
- Window opening measure only
- Panel and frame are pre-hinged
- Frame is not pre-drilled
- Standard, signature, legacy, bullnose, craftsman—factory automatically makes deductions: width— $\frac{5}{16}$ " (0.8 cm), for Height, see chart
- Tilt-out Z-frame—factory makes no deductions, measurement is the same as the window opening (see proper application of the Tilt-out Z-frame)

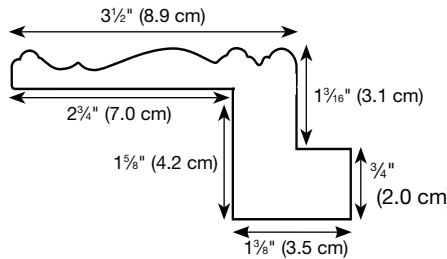

Legacy Z-Frame

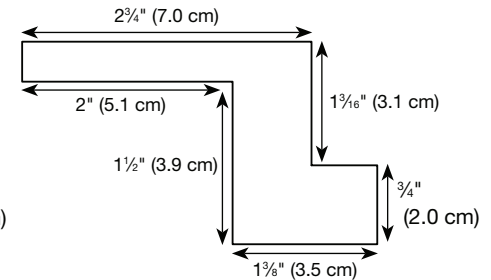

Craftsman Z-Frame

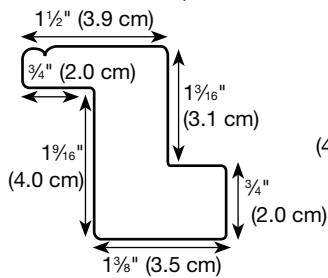

Standard Z-Frame

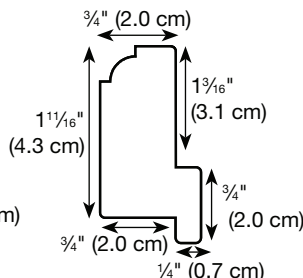

Tilt-Out Z-Frame

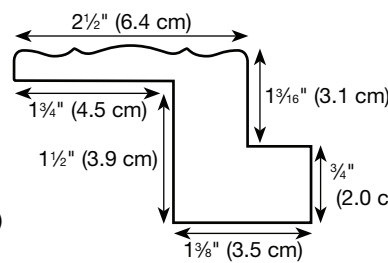

Signature Z-Frame

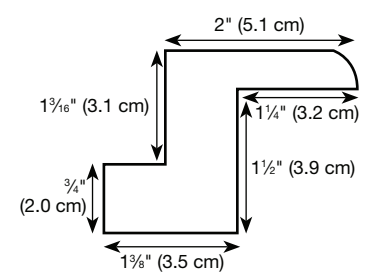

Bullnose Z-Frame

Deco Frames

- Outside mount only
- Frame-to-frame measure only
- Panel and frame are pre-hinged
- Frame is not pre-drilled
- No factory deduction made

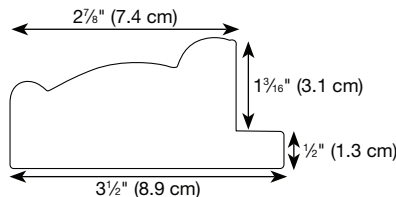

$\frac{3}{2}$ " (8.9 cm) Curved Deco

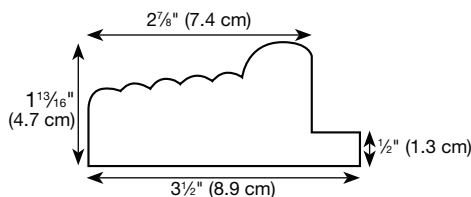

$\frac{3}{2}$ " (8.9 cm) Beaded Deco

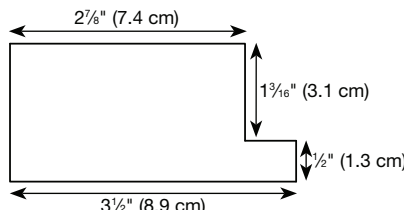

$\frac{3}{2}$ " (8.9 cm) Craftsman Deco

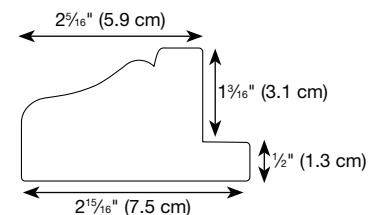

3" (7.7 cm) Traditional Deco

NOTE: Frames over 105" (266.7 cm) ordered size will be spliced.

Options

Wood Frame Product Detail

L-Frames

- Recommended outside mount
- Frame-to-frame measure only
- Panel and frame are pre-hinged
- Frame is not pre-drilled
- No factory deduction made

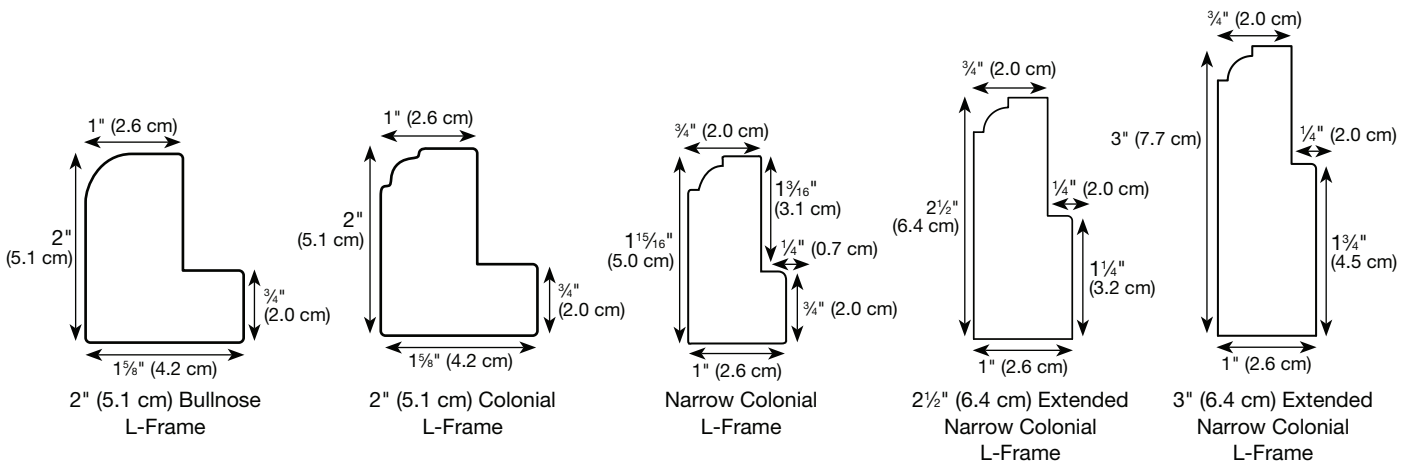
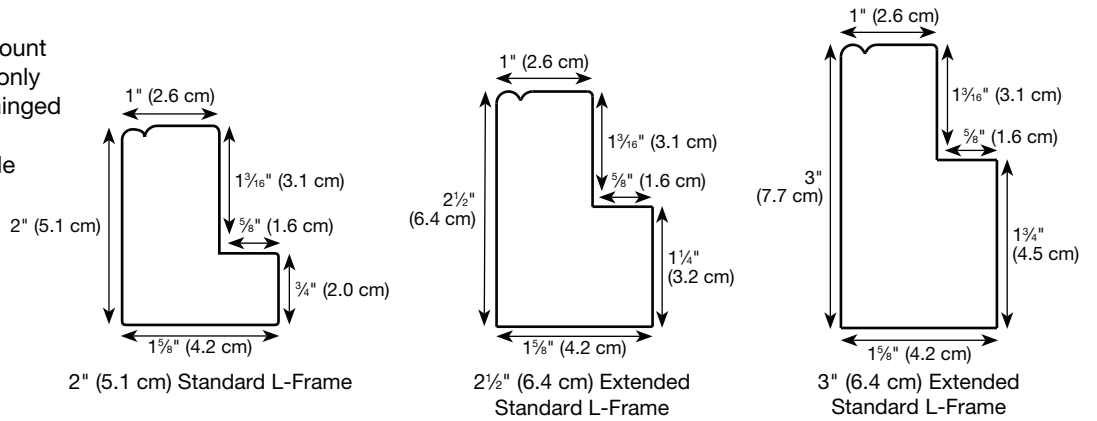

Sill Frames

- Offered with L, Z, and deco frames
- Not available with buildouts
- Not available with extended L-frames

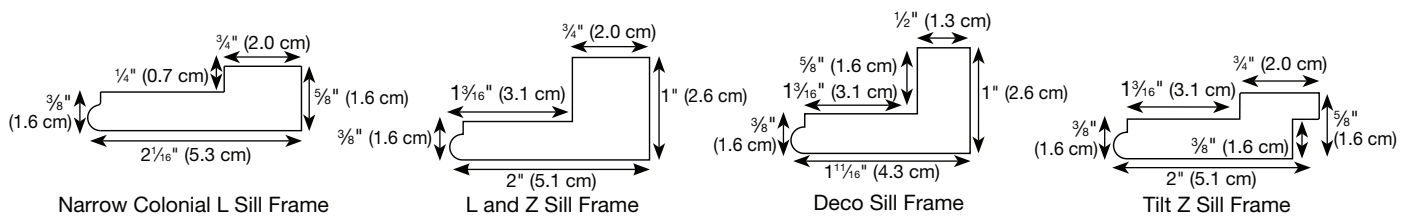

Sill Frame with Frame

- Sill frames are mitered to fit side frames and attached via ½" (1.3 cm) hoffman keys

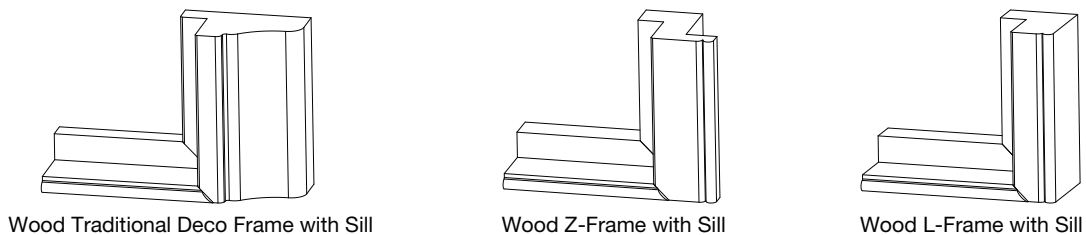

NOTE: Frames over 105" (266.7 cm) ordered size will be spliced.

Options

Wood Frame Product Detail

Side Light Frame

- Frame-to-frame measure only
- 4-sided configuration only
- Left or right panel configurations only
- 2½" (6.4 cm) or 3½" (8.9 cm) louvers only
- Frame shipped assembled
- Buildout available, attached at factory
- See side light frame section for more information

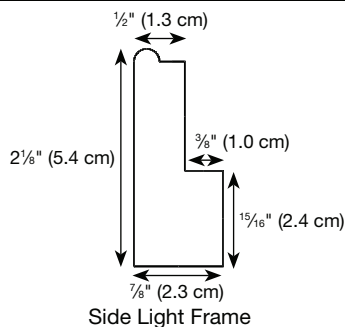

Sill Cap

- Available with all frames
- Available with following frame configurations: 3-sided inverted with sill cap bottom, 4-sided with sill cap bottom, 4-sided with sill frame top, and sill cap bottom
- Buildout included for inside mount frames (see sill cap application for ordering options)

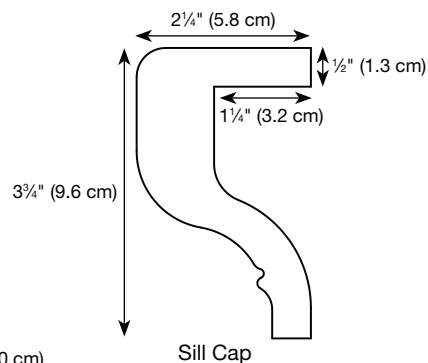

Light Block

- Included with hang strip, direct mount, 2-sided, and 3-sided frame types

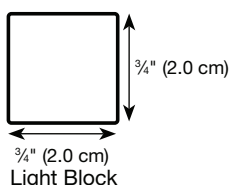

T-Post

- Vertical post that divides the panel into two sections
- T-post pre-drilled by factory

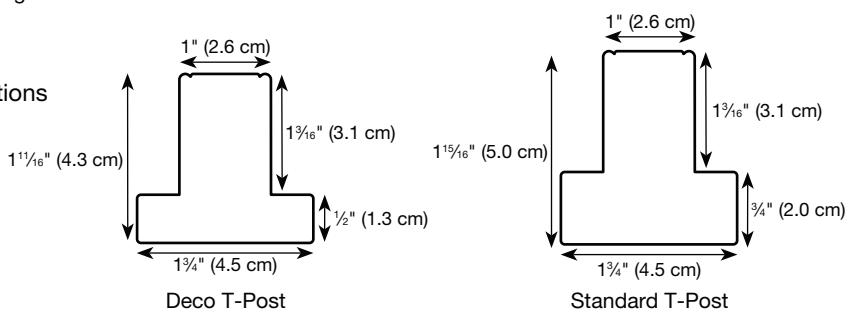

Buildout

- Used with L-frames, extended L-frames, deco frames, sidelight frame, and sill cap
- Available only in ½" (1.3 cm) thickness
- Maximum 2" (5.1 cm) (4 pieces) per shutter
- Not available with sill configurations

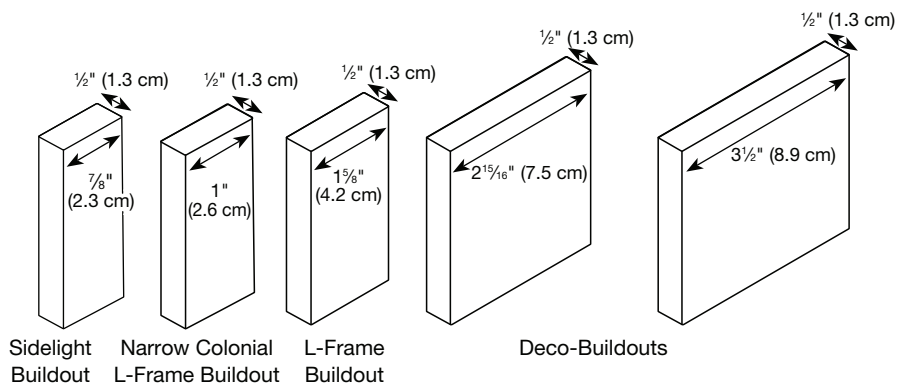

Corner Posts and Bay Posts

- A vertical post used for installing shutters in bay and corner windows
- See corner and bay post section for more information

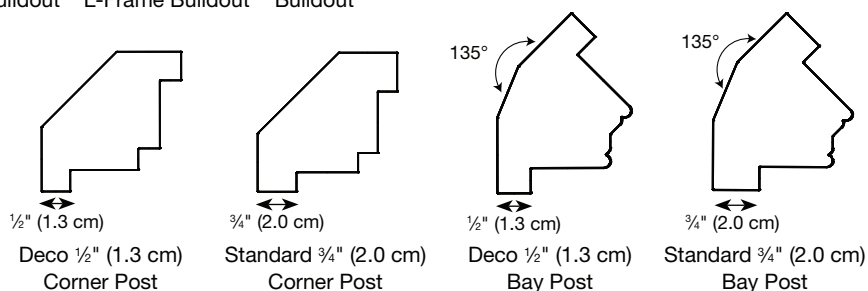

NOTE: Frames over 105" (266.7 cm) ordered size will be spliced.

Specifications

Deductions for Frame Allowances

Direct Mount

- Automatically taken at factory
- Width deduction— $\frac{3}{16}$ " (0.5 cm)
- Height deduction— $\frac{1}{4}$ " (0.7 cm)

Hang Strip

- Automatically taken at factory
- Width deduction— $\frac{3}{16}$ " (0.5 cm)
- Height deduction— $\frac{1}{4}$ " (0.7 cm)

Z-Frame (Standard, Signature, Legacy, Bullnose)

- Automatically taken at factory

Z-Frame Configuration	Frame Width Deduction inches (cm)	Frame Height Deduction inches (cm)
2-Sided	- $\frac{5}{16}$ (0.8)	No deduction*
3-Sided or 3-Sided Inverted	- $\frac{5}{16}$ (0.8)	- $\frac{5}{32}$ (0.4)*
3-Sided Sill Top or Bottom	- $\frac{5}{16}$ (0.8)	- $\frac{1}{16}$ (0.2)*
4-Sided	- $\frac{5}{16}$ (0.8)	- $\frac{5}{16}$ (0.8)
4-Sided Sill Top or Bottom	- $\frac{5}{16}$ (0.8)	- $\frac{5}{32}$ (0.4)
4-Sided Sill Top and Bottom	- $\frac{5}{16}$ (0.8)	- $\frac{1}{16}$ (0.2)

*Using this deduction, panel clearance on open ends of frame will automatically be $\frac{1}{8}$ " (0.4 cm).

L-Frames and Sidelights

- No deductions taken at factory
- If using for inside mount or in a tight spot, installer must make own deduction for proper fit

Deco Frame

- No deduction taken at factory
- If using in a tight spot, installer must make own deduction for proper fit

NOTE: Factory makes no deductions on tilt-out Z-frames, measured as window opening (see proper application of the tilt-out Z-frame). You must take your own deductions on tilt-out Z-frames

Installation Hardware

Included with order

- Hinge pins
- Installation screws (hinge, mounting, etc.)
- Touch up paint dabber—paints only
- Due to top coat process, touch-up bottles are not provided with stains but can be requested
- Hoffman keys

Available upon request—contact customer service

- Hinge shims
- Louver pins
- Screw caps (cover exposed screw heads)
- Screws

Specifications

Frame Configurations

2-Sided

Hang strip and direct mount with inside mount is available only in 2-sided frame (vertical). We will provide the light block at no charge for hang strip with inside mount.

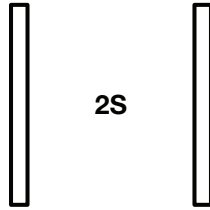

4-Sided with Sill Bottom

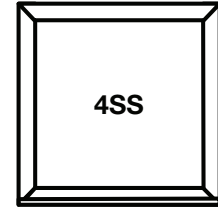

3-Sided

Light block included at no charge.

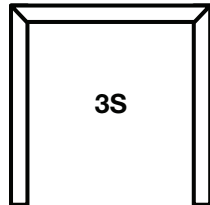

4-Sided with Sill Frame Top

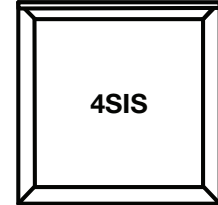

3-Sided Inverted

Light block included at no charge.

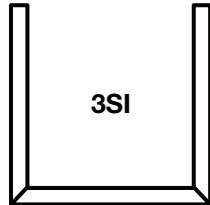

4-Sided

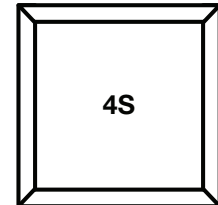

3-Sided with Sill Top

Light block included at no charge.

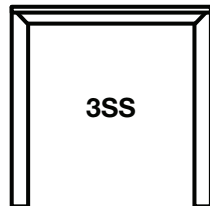

4-Sided with Sill Frame Top and Bottom

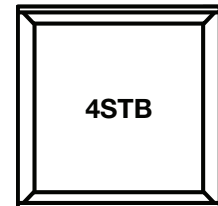

3-Sided Inverted with Sill Frame Bottom

Light block included at no charge.

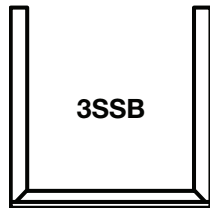

4-Sided with Sill Frame Top and Sill Cap Bottom

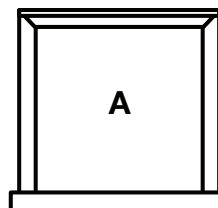

3-Sided Inverted with Sill Cap Bottom

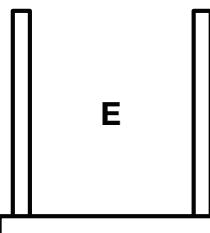

4-Sided with Sill Cap Bottom

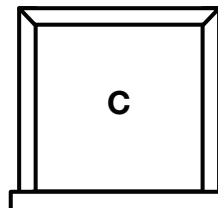

NOTE: Direct mount includes four light blocks at no charge.

Specialty Styles

Café Shutters

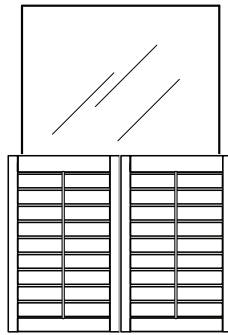

Shown as 2-Sided

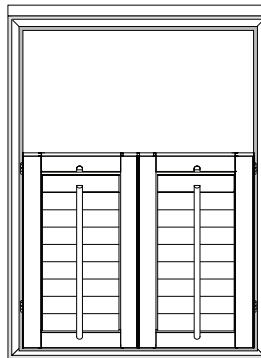

Shown as 4-Sided

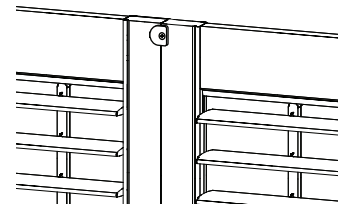

Rear View of Café Panel Optional:
Café Aligning Catch

- Tops of composite panels are not finished and are not recommended
- Café shutter panels cover the lower portion of the window
- Pricing is based on width x café panel height
- Optional café aligning catch
- Frame can be ordered to stop at panel height or can be ordered to fully frame the window

Order Entry Tip: When ordering frames to stop at panel height: 3-sided, 3-sided sill top, or 4-sided with or without sill configurations must be entered as standard shutters. 2-sided, 3-sided inverted, and 3-sided inverted sill bottom can be entered as cafe with panel and frame height the same size.

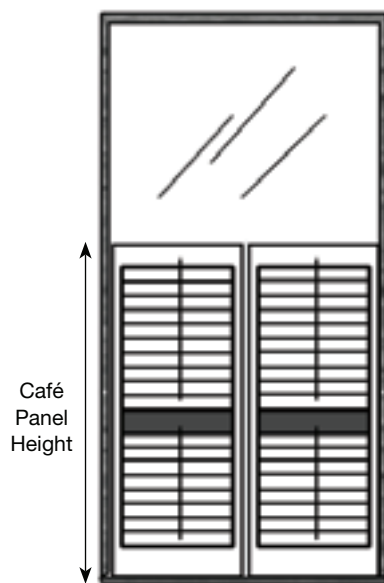

Includes the Bottom
Frame or Sill Frame
if Ordered

Café is available in a variety of frames, both inside and outside mount.

- Measure format depends on frame type selected
- For direct mount, use “window opening” size (WO) and no frame is furnished
NOTE: Panel will be 1/8" (0.4 cm) smaller than café panel height ordered for bottom swing clearance.
- For hang strip, use “window opening” size (WO) and hang strip will be the same height as café panel
NOTE: Panel will be 1/8" (0.4 cm) smaller than café panel height ordered for bottom swing clearance.
- For Z-frame, use “window opening” size (WO) and frame can be made at same height café panel or be made at window height for “full-height frame”
NOTE: The café panel height ordered will include whatever frame configuration ordered for the bottom. The cafe panel height is the height of the panels will stop at.
- For L-frame and deco frame, use “frame-to-frame” size (F-F) and frame can be made at the same height as café panel or be made at window height for “full-height frame”
NOTE: The café panel height ordered will include whatever frame configuration ordered for the bottom. The cafe panel height is the height of the panels will stop at.

*Shown with full window-height frame option.

Specialty Styles

Sunburst Arch without Frame

Specialty Shape without Frame: Panel Only

- Sunburst pattern—no horizontal louvers
- Beveled louvers for maximum light control
- Louver sizes will vary based on height and width of arch
- The arch has no tilt bar; the louvers open individually and are spring loaded at the bottom pin
- All wood and composite colors available; wood arches can be matched to composite colors
- Buildouts not available
- Panel is 1" (2.6 cm) thick and may not match projection of other outside mount standard shutters
- Order arch as frame-to-frame

- Allow sufficient wall space to mount; panel-only arches that are:

Wood Frameless Arch Base Width inches (cm)	Top Rail Size inches (cm)	Bottom Rail Size inches (cm)
20 (50.8) to less than 24 (61.0)	2 (5.1)	1 (2.6)
20 (50.8) to less than 45 (114.3)	3 (7.7)	2 (5.1)
45 (114.3) to less than 80 (203.2)	3 (7.7)	3 (7.7)
80 (203.2) to 108 (274.4)	4 (10.2)	4 (10.2)

NOTE: If mounting arch inside, take own deduction. Template recommended.

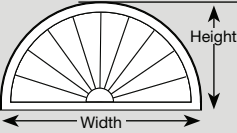
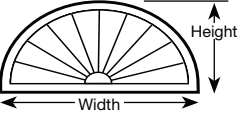
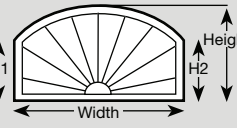
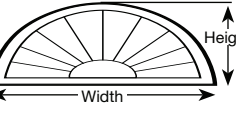
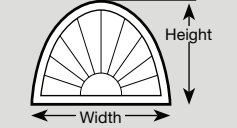
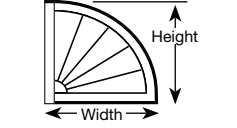
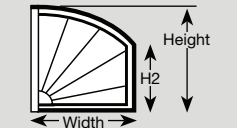
Specialty Shape without Frame: Minimum and Maximum Sizes				
Frameless—Panel Only	Width		Height	
	Minimum inches (cm)	Maximum inches (cm)	Minimum inches (cm)	Maximum inches (cm)
 <p>Perfect Sunburst Arch (order as Eyebrow) Height = 50% of width No templates required</p>	20 (50.8)	108 (274.4)	10 (25.4)	54 (137.2)
 <p>Eyebrow Sunburst Height Minimum = no less than 33% of width Height Maximum = no greater than 66% of width Template required if height exceeds 54% of width</p>	20 (50.8)	108 (274.4)	7 (17.8)	54 (137.2)
 <p>Elongated Sunburst Height Minimum = no less than 33% of width Height Maximum = no greater than 66% of width Template required if ordered height minus ordered leg height exceeds 54% of width</p>	20 (50.8)	108 (274.4)	10 (25.4)	71¼ (181.0)
 <p>Elliptical Sunburst (arch without a constant radius) Template always required</p>	20 (50.8)	108 (274.4)	7 (17.8)	54 (137.2)
 <p>Palladian Height Minimum = no less than 33% of width Height Maximum = no greater than 66% of width No template needed. Additional measurements required (see order form).</p>	20 (50.8)	108 (274.4)	7 (17.8)	71¼ (181.0)
 <p>¼ Eyebrow Leg minimum = 33% of width Leg maximum = 108% of width</p>	15 (38.1)	54 (137.2)	7 (17.8)	54 (137.2)
 <p>¼ Elongated Sunburst Arch Leg minimum = 33% of width Leg maximum = 132% of width</p>	15 (38.1)	54 (137.2)	10 (25.4)	71¼ (181.0)

Specialty Styles



Sunburst Arch with Frame

Frame Options	Z-Frames*	L-Frames**	Deco Frame
Mount	Inside mount only	Outside mount only	Outside mount only
Order Size	Window opening	Frame-to-frame	Frame-to-frame
Projection	3/8" (1.0 cm)	2" (5.1 cm), 2 1/2" (6.4 cm), 3" (7.7 cm)	1 1/16" (4.3 cm), 1 3/16" (4.7 cm)

*Framed arches not available with tilt-out Z-frame

**Narrow colonial L-frame will have 1 5/16" (2.4 cm) projection

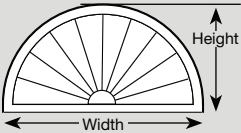
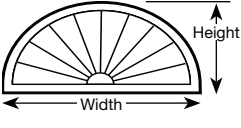
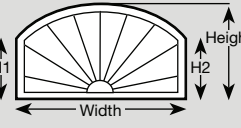
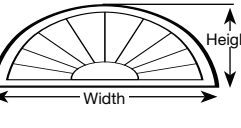
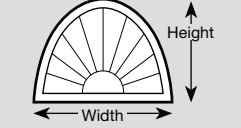
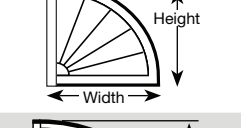
NOTE: All frame types are available with sill bottom. Buildouts are available on L-frame and deco frame arches without sill frames.

Framed Full and 1/4 Sunburst Arches		Width		Height	
		Minimum inches (cm)	Maximum inches (cm)	Minimum inches (cm)	Maximum inches (cm)
 <p>Perfect Sunburst Arch Height = 50% of width No templates required</p>	Z-frame	2 1/16" (55.5)	10 9/16" (279.0)	1 11/16" (30.1)	5 5/16" (141.8)
	L-frame	2 2/8" (56.2)	11 0/8" (279.8)	1 2/8" (30.8)	5 6/8" (142.6)
	3" (7.7 cm) deco frame	2 4/4" (62.9)	11 2/4" (286.4)	1 4/4" (37.5)	5 8/4" (149.3)
	3 1/2" (8.9 cm) deco frame	2 5/8" (65.8)	11 3/8" (289.3)	1 5/8" (40.4)	5 9/8" (152.1)
	Narrow colonial L-frame	2 1/8" (55.0)	10 5/8" (268.3)	1 1/8" (29.6)	5 5/8" (141.3)
 <p>Eyebrow Sunburst Height Minimum = no less than 33% of width Height Maximum = no greater than 66% of width Template required if height exceeds 54% of width</p>	Z-frame	2 1/16" (55.5)	10 9/16" (279.0)	8 3/16" (207.9)	5 5/16" (141.8)
	L-frame	2 2/8" (56.2)	11 0/8" (279.8)	9/8" (23.2)	5 6/8" (142.6)
	3" (7.7 cm) deco frame	2 4/4" (62.9)	11 2/4" (286.4)	1 11/8" (29.9)	5 8/4" (149.3)
	3 1/2" (8.9 cm) deco frame	2 5/8" (65.8)	11 3/8" (289.3)	1 2/8" (32.8)	5 9/8" (152.1)
	Narrow colonial L-frame	2 1/8" (55.0)	10 5/8" (268.3)	8/8" (22.0)	5 5/8" (141.3)
 <p>Elongated Sunburst Height Minimum = no less than 33% of width Height Maximum = no greater than 66% of width Template required if ordered height minus ordered leg height exceeds 54% of width</p>	Z-frame	2 1/16" (55.5)	10 9/16" (279.0)	1 11/16" (30.1)	7 3/16" (185.6)
	L-Frame	2 2/8" (56.2)	11 0/8" (279.8)	1 2/8" (30.8)	7 3/8" (186.4)
	3" (7.7 cm) deco frame	2 4/4" (62.9)	11 2/4" (286.4)	1 4/4" (37.5)	7 6" (193.1)
	3 1/2" (8.9 cm) deco frame	2 5/8" (65.8)	11 3/8" (289.3)	1 5/8" (40.4)	7 7/8" (195.9)
	Narrow colonial L-frame	2 1/8" (55.0)	10 5/8" (268.3)	1 1/8" (29.6)	7 2/8" (184.5)
 <p>Elliptical Sunburst (arch without a constant radius) Template always required.</p>	Z-frame	2 1/16" (55.5)	10 9/16" (279.0)	8 3/16" (207.9)	7 3/16" (185.6)
	L-frame	2 2/8" (56.2)	11 0/8" (279.8)	9/8" (23.2)	7 3/8" (186.4)
	3" (7.7 cm) deco frame	2 4/4" (62.9)	11 2/4" (286.4)	1 11/8" (29.9)	7 6" (193.1)
	3 1/2" (8.9 cm) deco frame	2 5/8" (65.8)	11 3/8" (289.3)	1 2/8" (32.8)	7 7/8" (195.9)
	Narrow colonial L-frame	2 1/8" (55.0)	10 5/8" (268.3)	8/8" (22.0)	7 2/8" (184.5)
 <p>Palladian Height Minimum = no less than 33% of width Height Maximum = no greater than 66% of width No template needed; additional measurements required (see order form)</p>	Z-frame	2 1/16" (55.5)	10 9/16" (279.0)	8 3/16" (207.9)	7 3/16" (185.6)
	L-frame	2 2/8" (56.2)	11 0/8" (279.8)	9/8" (23.2)	7 3/8" (186.4)
	3" (7.7 cm) deco frame	2 4/4" (62.9)	11 2/4" (286.4)	1 11/8" (29.9)	7 6" (193.1)
	3 1/2" (8.9 cm) deco frame	2 5/8" (65.8)	11 3/8" (289.3)	1 2/8" (32.8)	7 7/8" (195.9)
	Narrow Colonial L-Frame	2 1/8" (55.0)	10 5/8" (268.3)	8/8" (22.0)	7 2/8" (184.5)
 <p>1/4 Eyebrow Leg minimum = 33% of width Leg maximum = 108% of width</p>	Z-frame	1 6/16" (42.8)	5 5/16" (141.8)	1 11/16" (30.1)	5 5/16" (141.8)
	L-frame	1 7/8" (43.5)	5 6/8" (142.6)	1 2/8" (30.8)	5 6/8" (142.6)
	3" (7.7 cm) deco frame	1 9/4" (50.2)	5 8/4" (149.3)	1 4/4" (37.5)	5 8/4" (149.3)
	3 1/2" (8.9 cm) deco frame	1 20/8" (53.1)	5 9/8" (152.1)	1 5/8" (40.4)	5 9/8" (152.1)
	Z-frame	1 6/16" (42.8)	5 5/16" (141.8)	1 11/16" (30.1)	5 5/16" (141.8)
 <p>1/4 Elongated Sunburst Arch Leg minimum = 33% of width Leg maximum = 132% of width</p>	L-frame	1 7/8" (43.5)	5 6/8" (142.6)	1 2/8" (30.8)	5 7/8" (186.4)
	3" (7.7 cm) deco frame	1 19/4" (50.2)	5 8/4" (149.3)	1 4/4" (37.5)	5 7 6" (193.1)
	3 1/2" (8.9 cm) deco frame	1 20/8" (53.1)	5 9/8" (152.1)	1 5/8" (40.4)	5 7 7/4" (196.3)

NOTE: The following frames are not available for 1/4 arches: narrow colonial L-frames, bullnose Z-frames, craftsman Z and craftsman deco frames, 2 1/2" (6.4 cm) and 3" (7.7 cm) extended standard L-frames, 2 1/2" (6.4 cm) and 3" (7.7 cm) extended narrow colonial L-frames.

Specialty Styles

How to Make a Template (Recommended for Inside Mount Frameless Arches—Required for Elliptical Arches)

1. Tape paper over the window opening, allowing plenty of overlap. See below for template material information.
2. If your arch has a frame that requires a window opening measurement, draw an exact outline of the window opening. Manufacturing will take a deduction for proper fit. Be careful NOT to press in or crease the paper of the template while tracing. If your arch is frameless or has a frame that requires a F-F measurement, make template to the finished size you need. Your arch will be made to this size.
3. Remove the paper from the window opening and cut out the arch.
4. Fold template in half to verify template is symmetrical (mirror image). Template must be same on both sides and may require slight adjustment before shipping to Springs Window Fashions.
5. If adjustments are made to ensure template is symmetrical, place template back in window to ensure size and fit.
6. Mark the template with the following:
 - Room side
 - Purchase order number
 - Customer's name
 - Company name and account number
 - Frame-to-frame measurement (width) of shutter panels below the arch if applicable

-
- 7. Attach a copy of the purchase order to the template.
- 8. Roll the template and place it in a mailing tube.
- 9. DO NOT FOLD the TEMPLATE!
- 10. Mail to: Springs Window Fashions
8467 Route 405 South
P.O. Box 500
Montgomery, PA 17752
Attn: Shutter Department

Acceptable Materials for Making a Template*

- Kraft type paper
- Butcher paper
- Lightweight poster paper that can be rolled without creasing

Non-Acceptable Materials for Making a Template

- Newspaper
- Wrapping paper
- Tissue paper
- Fabrics
- Wood
- Wax paper

If the material used to make a template stretches, tears easily, will not lay flat after being rolled, or will mark the product in any way, Springs Window Fashions will refuse to use the template and require a new one.

*Use only tape that will not pull off paint or wallpaper.

NOTE: Comment on purchase order if a template is being sent, otherwise order will be processed without.

Manufacturer will not add to template. Provide finished size for frameless arches or a framed arch that requires a F-F measurement. Manufacturing will deduct from Z-frame window opening template size.

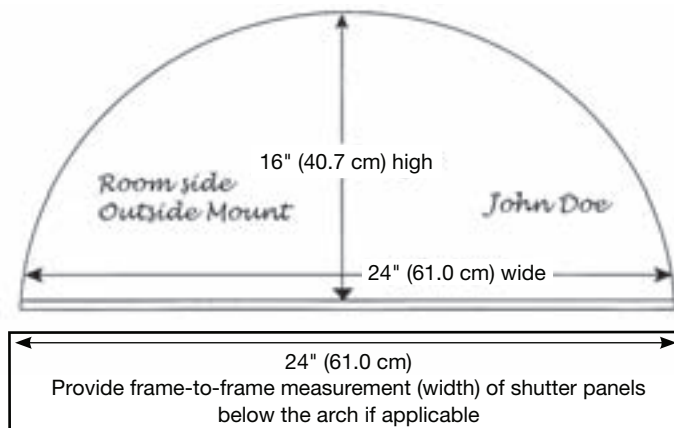

Must note on template:

- Purchase order number
- Customer's name
- Job number
- Account number

Specialty Styles

Framed Arch Installation Option

Arches arrive with the louvers not installed and packed separately. Louvers are numbered on bottom edge from right to left on the bottom as you look at the interior (room) side.

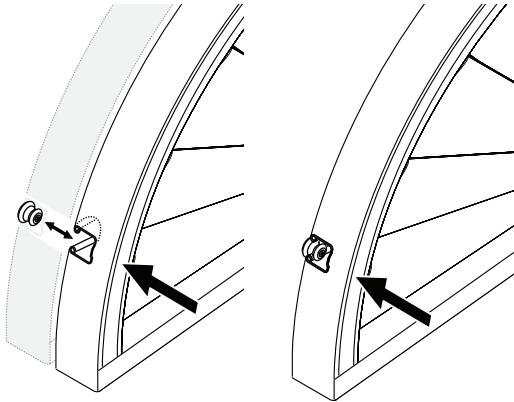

Framed Arch—Installing Panel to Frame

Button catch (imbedded) is standard. Panels are attached to frame via button catch. The frame itself installs as a standard L, Z, or deco frame.

Frameless Arch Installation Option

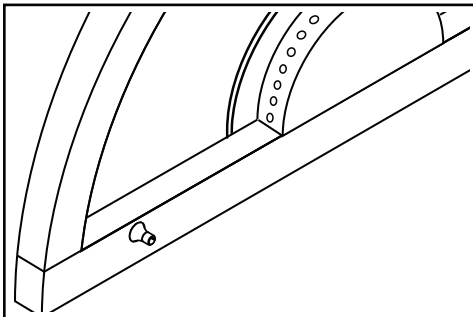

Bulldog Catch

Bulldog catch works best with window openings that have a square edge. Allows arch panel to be removed for cleaning. Available in White.

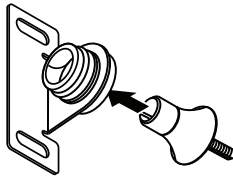

Suggested quantity usage:

Less than 36" (91.5 cm)—3

36" (91.5 cm) to 72" (182.9 cm)—5

72" (182.9 cm) to 108" (274.4 cm)—7

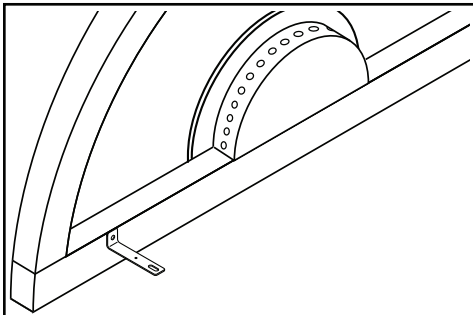

L-Bracket

L-bracket works best with windows that have a bull-nosed edge. Long-throw on the L-bracket allows you to reach past the curved window edge to a flat surface. L-bracket is zinc colored only.

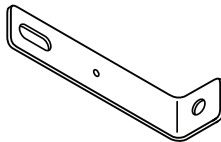

Suggested quantity usage:

Less than 36" (91.5 cm)—5

36" (91.5 cm) to 72" (182.9 cm)—7

72" (182.9 cm) to 108" (274.4 cm)—9

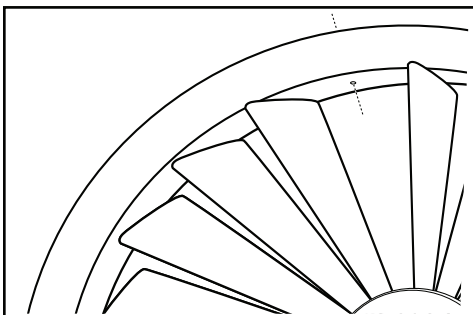

Trim Head Screw

If using trim head screws to mount, pilot a hole diagonally from underside of curved frame and exit through rear of frame. Place screw hole near louver pin to help hide hole from view.

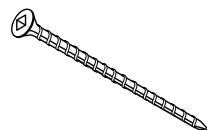

Specialty Styles

Arch and Angle Top Panel Shutters

- 2½" (6.4 cm), 3½" (8.9 cm) and, 4½" (11.5 cm) louvers available
- All wood colors available, wood arched or angled panel can be matched to composite colors
- Astragal, Hide-a-Tilt™ and split tilt available
- **NOTE:** Hide-a-Tilt only tilts up
- All frames except tilt-out Z-frames available (see below for additional restrictions)
- All panel configurations in standard shutters available
- Available frame configurations: 3-sided (3S), 4-sided (4S), 4-sided with sill bottom (4SS), 4-sided with sill bottom (C)
- Buildouts available for L-frames and deco frames (N/A with sill frame)
- Split tilt can be specified
- Split tilt and divider rail will have a +/- 2" (5.1 cm) tolerance
- Tilt-out Z-frame is not available on any arch/angle top panels

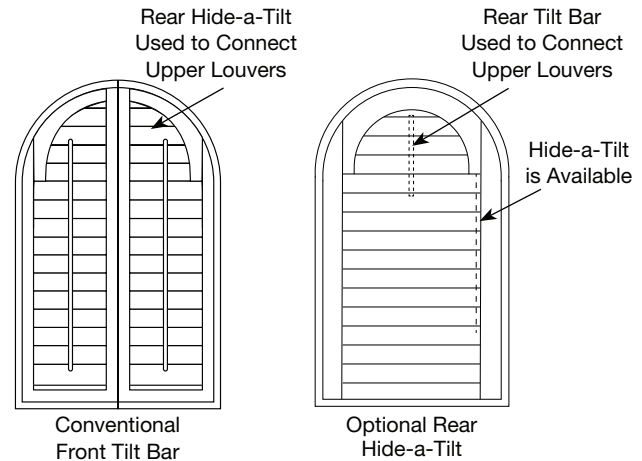

The following frames are **NOT AVAILABLE** for ¼ arch panel, angle, ½ angle, or any arch or angle panel with T-post:

- Narrow colonial L-frame
- Bullnose Z-frame
- 2½" (6.4 cm) and 3" (7.7 cm) extended standard L-frames
- 2½" (6.4 cm) and 3" (7.7 cm) extended narrow colonial L-frames
- Craftsman Z and craftsman deco frame
- Tilt-out Z-frame
- Sill cap

Louver Tilt is restricted up to 90° (degrees)

Louver tilt is restricted up to 90° (degrees) due to the curvature (or slope) at the top of the panel. A divider rail can be used to separate the upper arch portion from the lower rectangular portion. This will allow for full louver rotation of the louvers below the divider rail.

Measuring Leg Height and Divider Rail Height for Window Opening

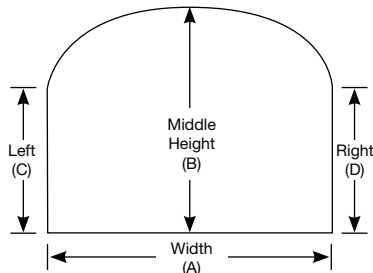

Frames requiring WO measurement:
Z-frame, hang strip, and direct mount.

Measuring Leg Height:

Measure from bottom of window up to arch "break point". Minimum leg height is 13" (33.1 cm).

Measuring Divider Rail Height:

Measure from bottom of window up to center of divider rail.

Measuring Leg Height and Divider Rail Height for Frame-to-Frame Measurement

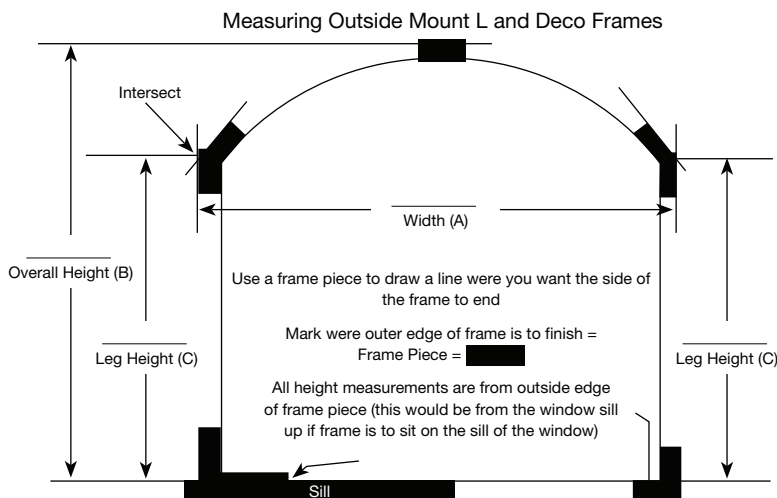

Frames Requiring

F-F Measurement:

L-frames and deco frames

Measure Leg Height:

Measure from bottom edge of frame up to arch "intersect" of the window (C). Minimum frame height is 13" (33.1 cm).

Measuring Divider Rail Height:

Measure from bottom of frame up to center of each divider rail.

NOTE: Divider rail requirements are the same as standard shutters. Only one divider rail available on arches/angles. Template required when the ordered height minus the leg height is over 54% of the width.

Specialty Styles

Arch and Angle Top Panel Shutters: Minimum/Maximum Height

See size considerations for width minimums and maximums.

Ordered Height Limitations for Arched and Angle Top Shutters					
	Frame Configuration	Frame Type	Minimum		Maximum
			2½" (6.4 cm) and 3½" (8.9 cm) Louvers inches (cm)	4½" (11.5 cm) Louver inches (cm)	2½" (6.4 cm), 3½" (8.9 cm), and 4½" (11.5 cm) Louver inches (cm)
Window Opening	2-sided	Hang strip/direct mount	15¼ (38.8)	20¼ (51.5)	120¼ (305.5)
	3-sided	Z-frames	16⅞ (41.0)	21⅞ (53.7)	121⅞ (307.7)
	4-sided with sill bottom	Z-frames	16⅞ (41.0)	21⅞ (53.7)	121⅞ (307.7)
	4-sided	Z-frames	17⅞ (43.4)	22⅞ (56.1)	122⅞ (310.1)
Frame-to-Frame	3-sided	L-frames	16¼ (41.3)	21¼ (54.0)	121¼ (308.0)
	4-sided with sill bottom	L-frames	16¼ (42.6)	21¼ (55.3)	121¼ (309.3)
	4-sided	L-frames	17¼ (43.9)	22¼ (56.6)	122¼ (310.6)
	3-sided	Deco frames (curved/beaded/craftsman)	18⅞ (46.1)	23⅞ (58.8)	123⅞ (312.8)
	4-sided with sill bottom	Deco frames (curved/beaded/craftsman)	18⅞ (47.0)	23⅞ (59.7)	123⅞ (313.7)
	4-sided	Deco frames (curved/beaded/craftsman)	21 (53.4)	26 (66.1)	126 (320.1)
	3-sided	Traditional deco frames	17⅞ (44.7)	22⅞ (57.4)	122⅞ (311.4)
	4-sided with sill bottom	Traditional deco frames	17⅞ (45.6)	22⅞ (58.3)	122⅞ (312.3)
	4-sided	Traditional deco frames	19⅞ (50.5)	24⅞ (63.2)	124⅞ (317.2)
	3-sided	Narrow colonial L-frames	16 (40.7)	21 (53.4)	121 (307.4)
	4-sided with sill bottom	Narrow colonial L-frames	16½ (42.0)	21½ (54.7)	121½ (308.7)
	4-sided	Narrow colonial L-frames	16¼ (42.6)	21¼ (55.3)	121¼ (309.3)

NOTE: Tilt-out Z-frame not available (see additional restrictions on previous page).
Minimum leg height is 13" (33.1 cm) on arch top panels and angle tops.

French Door Shutters

- 2½" (6.4 cm), 3½" (8.9 cm), and 4½" (11.5 cm) louvers
- Hide-a-Tilt™, split tilt, and double mouse hole available
- All wood colors available; wood French doors can be matched to composite colors
- Single panels hinged on the same side as the door
- L-frames include standard L-frames, extended standard L-frames, narrow colonial L-frame, extended narrow colonial L-frames
- Order frame-to-frame
- Outside mount only
- Divider rails are not available
- Buildouts can be requested at time of order; extended L-frames provided as necessary
- Button catches plus magnets are standard to provide for a secure closure
- Narrow colonial L-frame is made with magnet catch closure only

Projection Based on Louver Size inches (cm)	Standard L, Narrow Colonial L-Frame inches (cm)
2½ (6.4)	2" (5.1 cm) L-frame
3½ (8.9)	2½" (6.4 cm) L-frame
4½ (11.5)	3" (7.7 cm) L-frame

Manufacturing will automatically use a larger standard L/narrow colonial L-frame projection to your order according to the louver size. An additional ½" (1.3 cm) or 1" (2.6 cm) can also be requested if needed for louver clearance on larger trims. Factory will also make all adjustments to back plate elevation based on trim projection and extra buildout requested.

Extended standard L-frames and extended narrow colonial L-frames will be in one piece.

NOTE: All French door shutters for cut-out and no cut-out should be ordered at the same time.

French Door Shutters: Minimum/Maximum French Door Sizes

	Minimum inches (cm)	Maximum inches (cm)
Width	16¼ (42.6)	38¼ (97.2)
Height	37¼ (95.9)	90¼ (229.3)

Specialty Styles

French Door Shutters: Cut-Out Options

L-Frame
No Cut-Out

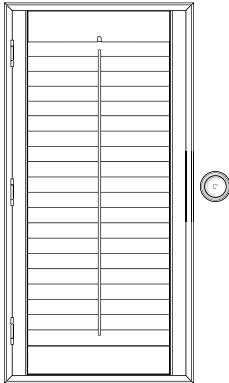

Rectangular Cut-Out
(surcharge applies)

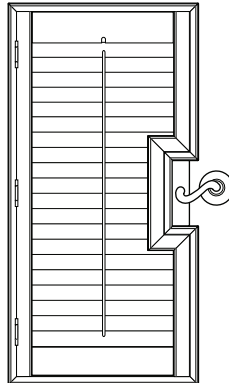

Curved Cut-Out
(surcharge applies)

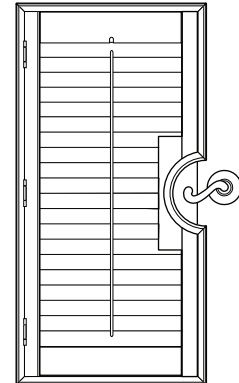

This should only be ordered when installed next to a French door with cut-out, otherwise order it as a standard shutter.

Order Rectangular Cut-Out When:

1. Choose if the base of the door hardware is rectangular.
2. Must specify width and height of the cut-out. There are no set standard sizes to conform to. There are no templates to use.
3. Be sure to make proper allowances for the door handle to pivot easily when determining your cut-out size.

Order a Curved Cut-Out When:

1. Choose a cut-out if the base of the door handle (or knob) is round.
2. Five (5) standard cut-out sizes are available:
Three (3) half-circles and two (2) half-ovals.
3. Other custom sizes of curved cut-outs are not available.
4. Be sure to make proper allowances for the door handle to pivot easily when determining your cut-out size.

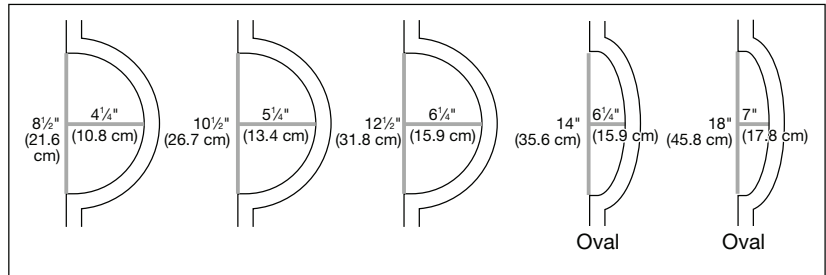

This image is taken from the backside of the French door order form.

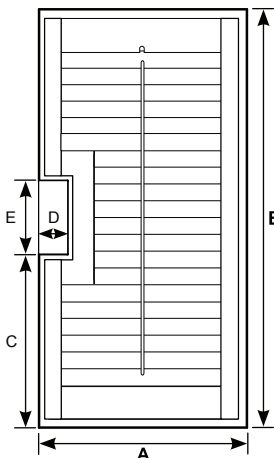

Rectangular Cut-Out

- A= Shutter width—frame-to-frame
- B= Shutter height—frame-to-frame
- C= Bottom of shutter frame to bottom of cut-out
- D= Width of cut-out
- E= Height of cut-out

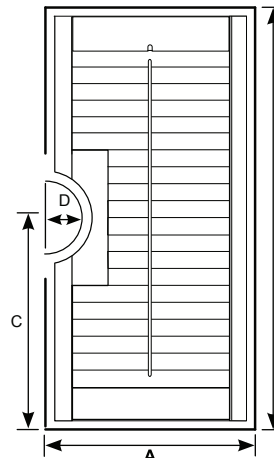

Curved Cut-Out

- A= Shutter width—frame-to-frame
- B= Shutter height—frame-to-frame
- C= Bottom of shutter frame to center of cut-out
- D= Width of cut-out

Specialty Styles

French Door Shutters: Placement of L-Frame

L-frame always sits outside of the trim, never on the trim. If no raised trim, place the L-frame far enough beyond the glass to rest totally flat on the door and to avoid risk of breaking the glass when driving the mounting screws in place. Use caution when placing screws, as the glass often extends under the trim and could easily crack.

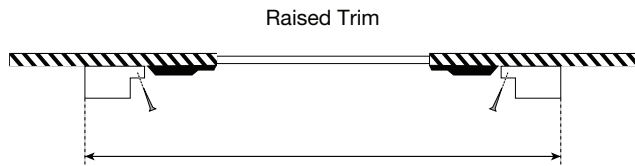

Always Use **Frame-To-Frame Measure Format** for French Doors

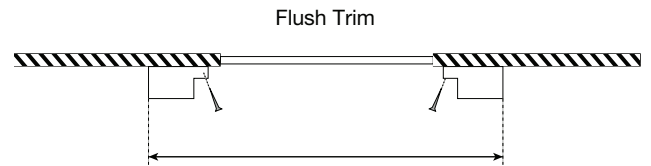

Always Use **Frame-To-Frame Measure Format** for French Doors

French Door Shutters: Recessed Back Plate

A “recessed back plate” is required when there is insufficient space between the base of the door hardware and the glass trim to place L-frame flat on the door surface.

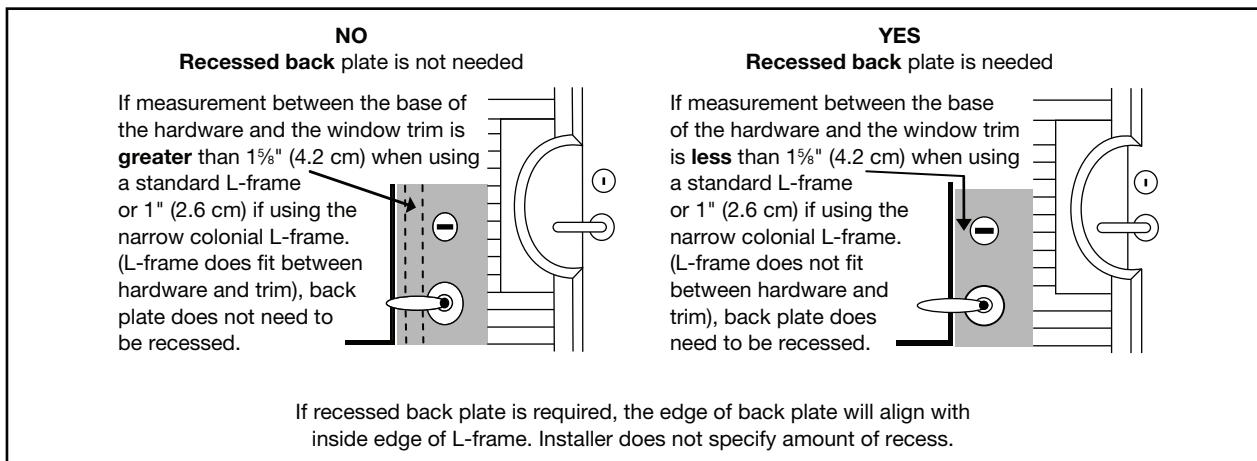

Caution:

1. When measuring (F-F) width and height, be sure that L-frame can rest flat on the door surface and not be obstructed by the glass trim.
2. If “yes” is selected, the edge of the recessed back plate will be built to align with the inside edge of the L-frame (as shown by the dotted line in the upper drawing).

Specialty Styles

Bypass Shutters

- Ideal solution for large windows and patio doors
- System consists of a double-top track and floor guides (no bottom track)
- All wood colors options available
- Available in all louver sizes
- Available with Hide-a-Tilt™ and split tilt
- Available with double mouse hole
- See the minimum and maximum order sizes charts (factory to determine panel size based on width ordered and configuration)
- Divider rail required over 84" (213.4 cm) ordered height
- Tracks wider than 144" (365.8 cm) will be spliced
- Header and valance could be spliced over 96" (243.9 cm)
- Mounting options:
 - Outside mount—with or without box-out (box-out recommended)
 - Exact frame-to-frame with box-out
 - Inside mount—minimum window depth 5 $\frac{3}{8}$ " (13.7 cm)
- All mounting options:
 - Track and header board: unit includes 2 tracks installed to header, header is 5 $\frac{1}{2}$ " (14.0 cm) deep and $\frac{3}{4}$ " (2.0 cm) thick
 - Valances: 2 top treatments available; 5" (12.7 cm) double beaded standard valance, 4 $\frac{1}{2}$ " (11.5 cm) decorative valance (optional)
 - Outside mount is available with stack back or custom header (see bypass track system for details)

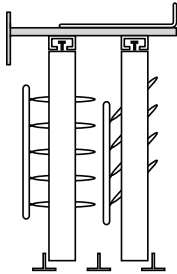

NOTE: Louvers must be closed in order for panels to pass each other.

Valance Options



4 $\frac{1}{2}$ " (11.5 cm) Decorative Valance



5" (12.7 cm) Standard Valance

Specialty Styles

Bypass Shutters: Mounting Options

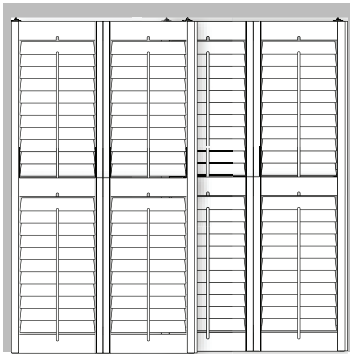

Outside Mount— with Factory Additions:

Width Measure (with box-out): If no window trim: measure window opening size. If window trim: measure outside edge of trim to outside edge of trim and record as window opening size. **Regardless of ordered size, factory will add 3¼" (8.3 cm) to your overall ordered width.**

NOTE: When measuring, add more for bullnose drywall so that the frames mount completely on flat surface.

Width Measure (without box-out): If no window trim: measure window opening size. If window trim: measure outside edge of trim to outside edge of trim and record as window opening size. **Regardless of ordered size, factory will add 1¼" (3.2 cm) to your overall ordered width.**

NOTE: When measuring, add more to extend beyond window edge for more privacy.

Height Measure (with or without box-out): If no window trim: measure from floor surface to top of the window opening. If window trim: measure to top of window trim. **Regardless of ordered size, factory will add 2⅝" (6.7 cm) to your overall ordered height.**

Other Measuring Considerations: ½" (1.3 cm) buildout is available.

Valance Information: Valance returns are included and wrap around the outside of the box-out if ordered. Returns are mitered and measure 5⅞" (15.0 cm) (special valance width and return width available).

Box-Out Information: Optional side frames are 5½" (14.0 cm) deep and ¾" (2.0 cm) thick.

Stack Back Information: Optional to allow shutter panels to clear the window opening, factory will calculate based on ordered size. Custom/special header board size is also available if full stack back cannot be achieved.

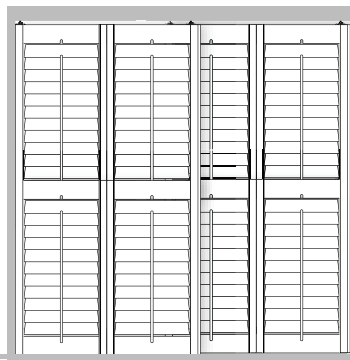

Outside Mount—Exact Frame-to-Frame:

Width and Height Measure: Factory will not add or deduct from ordered size—measure width and height as finished frame to frame size including the box-out. Only available with box-out.

Other Measuring Considerations: ½" (1.3 cm) buildout is available.

Valance Information: Valance returns are included and wrap around the outside of the box. Returns are mitered and measure 5⅞" (15.0 cm) (special valance width and return width available).

Box-Out Information: Required box-out side frames are 5½" (14.0 cm) deep and ¾" (2.0 cm) thick.

Stack Back Information: Stack back and custom/special header board size is not available.

Inside Mount— with Factory Deductions:

Width Measure: Order window opening width and factory will make a ½" (1.3 cm) deduction off the track for proper fit.

Height Measure: Order window opening height and factory will make a ½" (1.3 cm) deduction. The carriers are adjustable.

Other Measuring Information: Minimum window depth required for 5⅞" (13.7 cm). No buildouts available.

Valance Information: Special valance width available. Valance returns and special return width not available.

Box-Out Information: Not available.

Stack Back Information: Stack back and custom/special header board size is not available.

Specialty Styles

Bypass Track System Configuration Options: Only Configurations Available

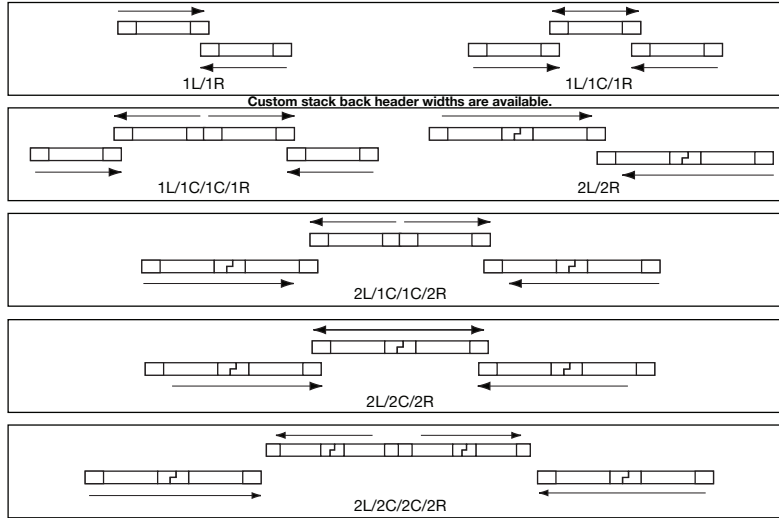

Bypass Shutter: Minimum/Maximum Width Order Size by Panel Configuration

Panel Configuration	Example of Shutter Unit Configurations Using Various Panel Combinations	Outside Mount with Additions		Inside Mount		Outside Mount—Exact	
		Order WO Size		Order WO Size		Exact Frame-to-Frame	
		Minimum Width inches (cm)	Maximum Width inches (cm)	Minimum Width inches (cm)	Maximum Width inches (cm)	Minimum Width inches (cm)	Maximum Width inches (cm)
1L/1R		18 (45.8)	70 (177.8)	20 (50.8)	71 (180.4)	19¼ (48.9)	73 (185.5)
1L/1C/1R*		27½ (69.9)	104 (264.2)	28½ (72.4)	106½ (270.6)	27¾ (70.5)	108¾ (276.3)
1L/1C/1C/1R		37 (94.0)	141 (358.2)	38 (96.6)	142 (360.7)	36¾ (92.1)	144¼ (366.4)
2L/2R		37¾ (95.9)	141¾ (360.1)	38¾ (98.5)	142¾ (362.6)	36 (91.5)	145 (368.3)
2L/1C/1C/2R*		56 (142.3)	212 (538.5)	58½ (147.7)	213 (541.1)	54¼ (137.8)	216¼ (549.3)
2L/2C/2R*		57½ (145.1)	213½ (541.4)	58½ (147.7)	213 (541.1)	54¼ (137.8)	216¼ (549.3)
2L/2C/2C/2R		76½ (194.4)	284½ (722.7)	77½ (196.9)	285½ (725.2)	71¼ (182.5)	287¼ (731.1)

*Window opening is 33% with these panel configurations. stack back or custom header recommended.

Same minimum/maximum sizes apply if ordered with stack back options and with or without box-out.

NOTE: Combinations with a 2C, 2L, or 2R will be rabbeted together and move as one unit.

Setting Bracket Height

(for outside mount without side frames)

For wall mount bypass shutter system

Top of angle bracket to floor:

Top of bracket will be 3¾" (9.9 cm) above ordered height.

This includes ½" (1.3 cm) clearance off the floor.

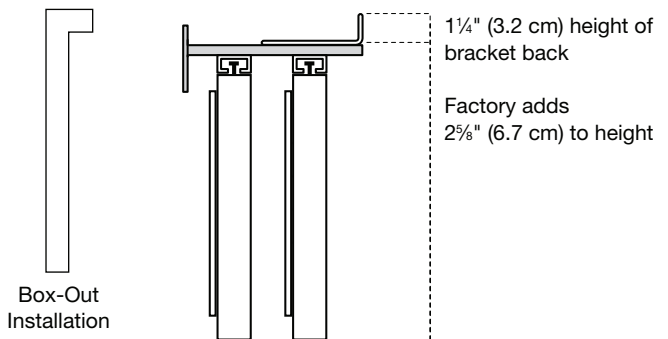

Wood Bypass Height Minimum and Maximum		
Options	Minimum inches (cm)	Maximum inches (cm)
Outside Mount	15¾ (39.1)	120¾ (305.8)
Inside Mount	17¼ (43.9)	122¼ (310.6)
Exact	15¾ (39.1)	122¼ (310.6)

NOTE: With optional box-out, side frames determine the mounting height. Bottom edge of side frame is meant to touch the floor surface.

Specialty Styles

Bypass Track System

Stack Back Option

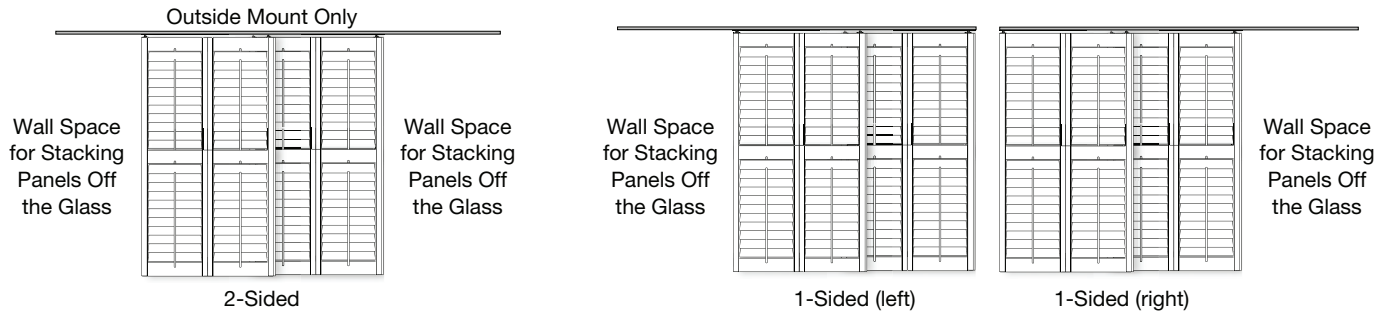

The stack back option allows for the shutter panels to clear the window opening, creating an unobstructed view. **Panels made to cover window. Header/track made larger so panels stack off glass.**

Measure only the window opening area for outside mount with stack back. Factory will calculate the correct stack back needed for full stack back. Custom header also available.

System consists of a double-top track and floor guides

Calculating Approximate Stack Back: Factory will add additional width to ordered size for stack back. Amounts vary depending on the number of panels. See chart below for total (approximate) amount that will be added to the window opening size. This determines the approximate overall unit width.

% of Window Opening Size Added for Various Numbers of Panels				
2	3	4	6	8
50%	66%	50%	66%	50%

Custom Header

If wall space is not available for complete stack back, custom header size may be ordered. Give window opening size and custom header size.

- Panels will be built to cover the window opening size
- The track, header, and valance will be built to the custom size requested

ORDERING ENTRY TIP: Enter the opening size as the ordered width.

Choose "no" for stack back and then place desired finished size in the custom header field.

Specialty Styles

Bifold Track System

- System consists of top and bottom track and quarter-round as standard
- Available in all louver sizes
- All wood colors options are available
- Available with Hide-a-Tilt™
- Available with double mouse hole

Configuration Options:

- Outside mount with box-out
- Outside mount with stack back
- Inside mount

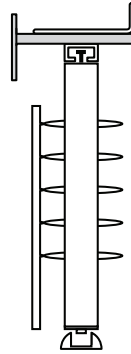
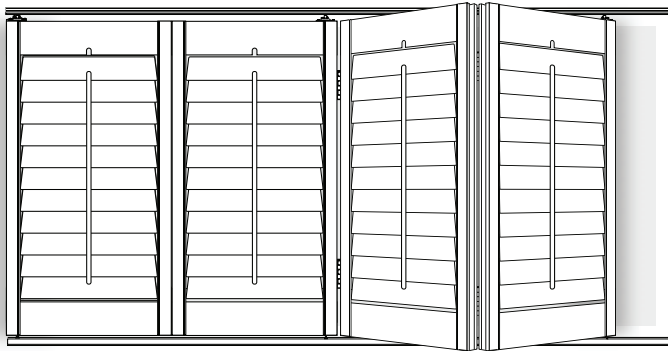

Bottom Track Detail

Installer screws the track to the floor and attaches "quarter-round" up to the face of the track (and along the back of the track, if needed).

NOTE: Factory does not supply adhesive, trim nails or other fasteners to install quarter-round.

NOTE: Factory always furnishes bottom track. Installer determines whether bottom track is needed.

Bifold Mounting Options

Outside Mount Notes

Width Measurement (using the required box-out): If no window trim: measure window opening (WO) size. If window trim: measure outside edge of trim to outside edge of trim. **Factory will add 5" (12.7 cm) to your overall ordered width.**

NOTE: When measuring, add more for bullnose so that frames mount completely on flat surface.

Height Measurement: If no window trim: measure from floor surface to top of window opening.

If window trim: measure to top of window trim. **Factory will add 3½" (8.9 cm) to your overall ordered height.**

Other Measurement Considerations: If there are window moldings, factory can accommodate only up to ½" (1.3 cm) thick molding when using 3½" (8.9 cm) louvers and Hide-a-Tilt.

Track and Header Board: Unit includes track installed to header board. Header is 3½" (8.9 cm) deep and ¾" (2.0 cm) thick.

Valances and Returns: One top treatment style is available: standard 2⅝" (6.1 cm) single-bead valance. Valance returns are included and wrap around the outside of the box-out (frame). Returns are mitered and are 3⅞" (9.9 cm) (inside measurement). Refer to the valance options.

Box-Out (side frames): Sides frames are required for securing the pivot set of outermost panels.

Box-out frame is ¾" x 3½" (2.0 cm x 8.9 cm).

Stack Back Available: Optional stack back is available for outside mount bifold shutters. Custom stack back widths are available.

Inside Mount Notes

Width Measurement: Order WO (window opening) and provide net window width. Factory will make a ½" (1.3 cm) deduction from the track for proper fit.

Height Measurement: Order WO (window opening) and provide net window height. Carriers are adjustable. **Factory will make approximately ½" (1.3 cm) deduction.**

Other Measurement Considerations: Minimum window depth requirement 3⅝" (9.3 cm). Standard edge gap (edge of panel to inside of window edge) is ⅝" (1.0 cm) on both sides of the units.

Track and Header Board: Unit includes track installed to header.

Valances and Returns: One top treatment style is available: standard 2⅝" (6.1 cm) single-bead valance. No returns are available. Valance ends are not mitered. Refer to the valance options.

Box-Out (side frames): Box-out is not available. The pivot set of outermost panels is secured to the inside of window opening.

Stack Back Not Available.

Specialty Styles

Bifold Track System: Minimum/Maximum Width by Panel Configuration

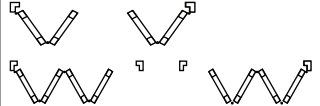
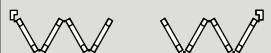
Panel Configuration	Example of Shutter Unit Configurations Using Various Panel Combinations	Outside Mount (with side frame)		Outside Mount with Stack Back (with side frame)		Inside Mount	
		Order WO Size		Order WO Size		Order WO Size	
		Minimum Width inches (cm)	Maximum Width inches (cm)	Minimum Width inches (cm)	Maximum Width inches (cm)	Minimum Width inches (cm)	Maximum Width inches (cm)
LL/RR		17 (43.2)	49 (124.5)	14 (35.6)	48 (122.0)	21 (53.4)	54 (137.2)
LLRR/LLLL/RRRR		38 (96.6)	100 (254.0)	32 (81.3)	95 (241.3)	41 (104.2)	105 (266.7)
LLLLRRRR		80 (203.2)	205 (520.7)	70 (177.8)	194 (492.8)	80 (203.2)	209 (530.9)

Wood Bifold Minimum and Maximum Height		
	Minimum inches (cm)	Maximum inches (cm)
Outside Mount	15 $\frac{1}{8}$ " (40.4)	122 $\frac{1}{8}$ " (310.2)
Inside Mount	17 $\frac{1}{8}$ " (45.5)	122 $\frac{1}{8}$ " (312.2)

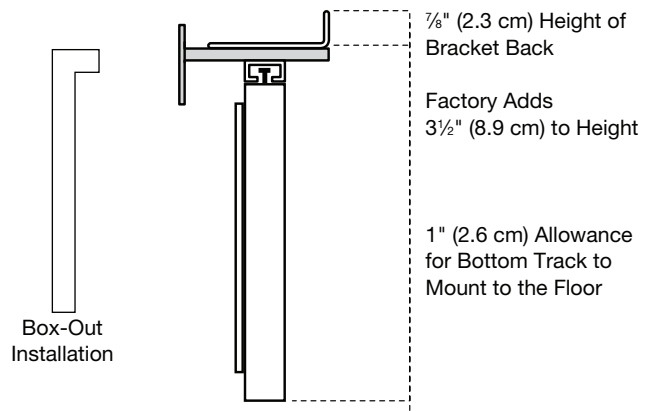

Setting Bracket Height (for outside mount)

For wall mount bifold shutter system

Top of angle bracket to floor:

- Top of bracket will be 5 $\frac{1}{8}$ " (13.7 cm) above ordered height

Bifold track system divider rail requirements

- Divider rail required over 84" (213.4 cm) ordered height
- Tracks wider than 144" (365.8 cm) will be spliced, header and valance may be spliced over 96" (243.9 cm) wide

NOTE: Side frames determine the mounting height. Bottom edge of side frame is meant to touch the floor surface.

Bifold Track System: Stack Back

Stack Back Option (surcharge applies):

The stack back option allows for the shutter panels to clear the window opening, creating an unobstructed view. **Panels made to cover window. Header/track made larger so panels stack off glass.**

Measure only the frame-to-frame area for outside mount with stack back. Factory will calculate the correct stack back needed for full stack back. Custom header also available.

Calculating Approximate Stack Back: Factory will add additional width to ordered size for stack back. Amounts vary, depending on the number of panels.

Valance Options



2 $\frac{3}{8}$ " (6.1 cm) Standard Valance

Specialty Styles

Side Light

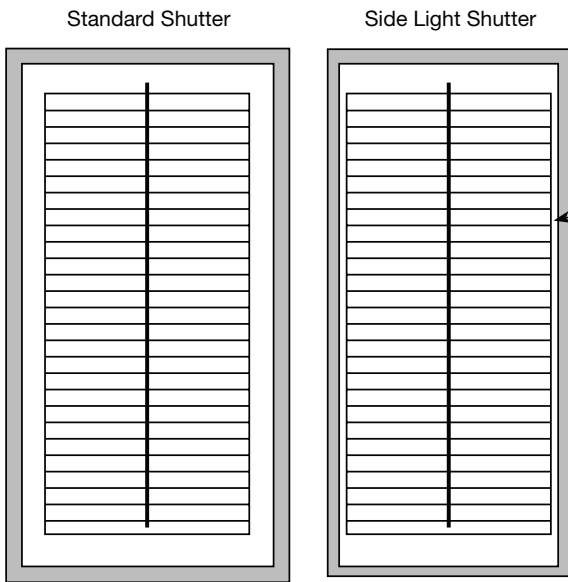

- 2½" (6.4 cm) and 3½" (8.9 cm) louvers only
- Low profile L-frame style, similar to sill frame
- 4-sided frame configuration only
- Frame-to-frame (F-F) measuring
- Narrow panel side stile width
- Left or right panel configurations only
- Divider rail never required, but is available
- Buildout is available and is automatically furnished when specifying 3½" (8.9 cm) louvers; maximum one layer of buildout; buildout is attached at the factory
- Available with Hide-a-Tilt™, split tilt, or double mouse hole

- Panel side stile = 2" (5.1 cm)
- Standard L-frame face width = 1" (2.6 cm)
- Panel side stile = 1⅜" (3.5 cm)
- Sidelight frame face width = ½" (1.3 cm)

Minimum and Maximum Sizes							
Width				Height			
Minimum Order Size (F-F size) inches (cm)	Maximum Order Size (F-F size) inches (cm)	Minimum Finished Panel Width inches (cm)	Maximum Finished Panel Width inches (cm)	Minimum Order Size (F-F size) inches (cm)	Maximum Order Size (F-F size) inches (cm)	Minimum Finished Panel Height inches (cm)	Maximum Finished Panel Height inches (cm)
7⅞ (18.3)	13⅞ (33.5)	6 (15.3)	12 (30.5)	16¼ (41.3)	97¼ (247.1)	15 (38.1)	96 (243.9)

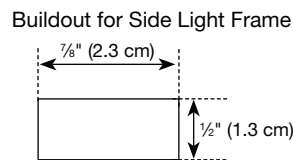
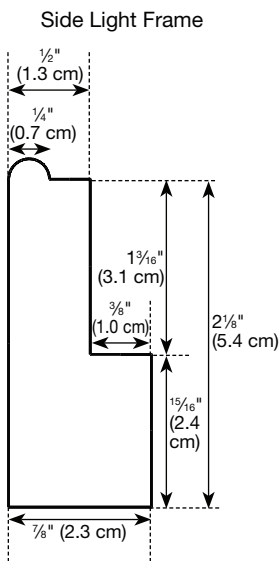

Specialty Styles

Bay Windows

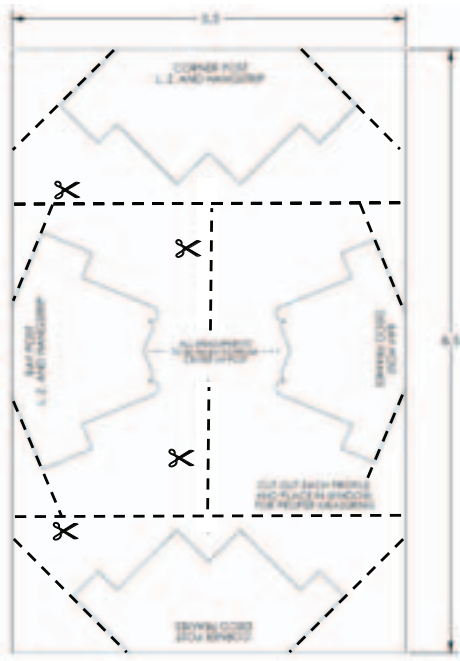

Frame (footprint) template available.
Cut out individual pieces for use during measure.

- 135° (degrees) angled bays only
- Framed configurations offered:
 - 2-sided framed configurations only
 - No 3-sided or 4-sided available
- Unframed configurations offered:
 - Direct mount and hang strip
- All frame styles available except tilt-out Z, narrow colonial L, extended standard L, bullnose Z, extended narrow colonial L, craftsman Z, and deco and sill cap
- T-posts are available (see parameters below)
- No buildout is available
- 2½" (6.4 cm), 3½" (8.9 cm), and 4½" (11.5 cm) louvers

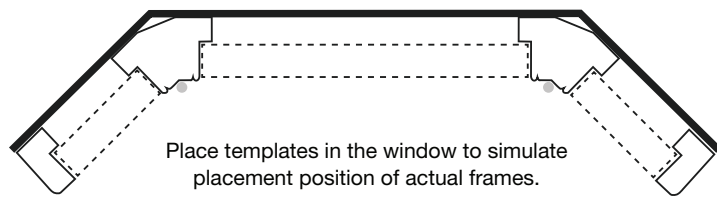

Place templates in the window to simulate placement position of actual frames.

Measuring Tips

1. For direct mount, hang strip, and Z-frame: Order WO. Measure from inner edge of window to center of bay post.
2. For L-frame and deco frame: Order F-F. Measure from outside edge of outer frame to center of bay post.
3. For center shutter: Measure from center of bay post to center of bay post.

Both measure formats use the (front) center of the bay post as reference points (see small dots on diagram above).

Available Panel Configurations by Window Locations—for Bay Windows

Side Windows: Choose from 1-panel or 2-panel configurations, including ones with one (1) T-post



Center Window: Choose from 1-panel, 2-panel, 3-panel, and 4-panel configurations, including ones with as many as three (3) T-posts







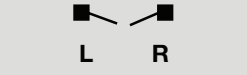
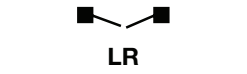
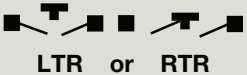
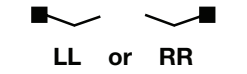

<p>1 Panel</p> <p>L R</p>	<p>1 Panel</p> <p>L R</p>
<p>2 Panels</p> <p>LR LL RR LTR RTR</p>	<p>2 Panels</p> <p>LR LL RR LTR RTR</p>
<p>3 Panels</p> <p>LLR LRR LLTR</p> <p>LTRR LTLTR LTRTR</p>	
<p>4 Panels</p> <p>LL RR LLTRR LRTLR</p> <p>LTLRTR LTRTLTR</p>	

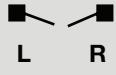
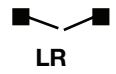
Specialty Styles

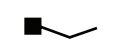
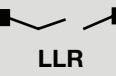
Bay Windows

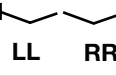
Minimum and Maximum Order Width Sizes by Fold Pattern by Frame Type

Panel Configurations Available for the Side Windows of the Bay		Direct Mount Hang Strip		Z-Frames		3" (7.7 cm) Traditional Deco Frame		3½" (8.9 cm) Curved/Beaded/Deco Frame		L-Frames	
		Order WO		Order WO		Order F-F Size		Order F-F Size		Order F-F Size	
		Minimum inches (cm)	Maximum inches (cm)	Minimum inches (cm)	Maximum inches (cm)	Minimum inches (cm)	Maximum inches (cm)	Minimum inches (cm)	Maximum inches (cm)	Minimum inches (cm)	Maximum inches (cm)
1 Panel		9 ¹³ / ₁₆ (23.4)	36 ¹³ / ₁₆ (93.6)	10 ⁹ / ₁₆ (26.9)	37 ⁷ / ₁₆ (95.5)	12 ¹ / ₈ (30.8)	39 ³ / ₈ (99.4)	12 ¹³ / ₁₆ (32.6)	39 ¹³ / ₁₆ (101.2)	10 ¹³ / ₁₆ (27.5)	37 ¹³ / ₁₆ (96.1)
2 Panel		18 ⁷ / ₁₆ (47.2)	72 ⁷ / ₁₆ (184.4)	19 ⁹ / ₁₆ (49.7)	73 ⁷ / ₁₆ (186.9)	20 ¹³ / ₁₆ (52.9)	74 ¹³ / ₁₆ (190.1)	21 ⁷ / ₁₆ (54.5)	75 ⁷ / ₁₆ (191.7)	19 ⁹ / ₁₆ (49.7)	73 ⁷ / ₁₆ (186.9)
2 Panel, 1 T-Post		20 (50.8)	74 (188.0)	20 ³ / ₄ (52.8)	73 ³ / ₈ (186.4)	22 ⁵ / ₁₆ (56.7)	75 ⁵ / ₈ (191.5)	22 ¹³ / ₁₆ (58.0)	75 ¹⁵ / ₁₆ (192.9)	21 (53.4)	74 (188.0)
1 Bifold		18 ⁷ / ₁₆ (47.2)	52 ⁷ / ₁₆ (133.6)	19 ⁹ / ₁₆ (49.7)	52 ⁷ / ₁₆ (133.6)	20 ⁷ / ₈ (53.1)	54 ⁷ / ₈ (139.4)	21 ⁷ / ₁₆ (54.5)	55 ⁷ / ₁₆ (140.9)	19 ⁹ / ₁₆ (49.7)	53 ⁷ / ₁₆ (136.1)

Panel Configurations Available for the Center Window of the Bay, Bay Post-to-Bay Post Only (no frame to consider)	Minimum inches (cm)	Maximum inches (cm)	
1 Panel		10 ⁷ / ₁₆ (26.6)	37 ⁷ / ₁₆ (95.1)
2 Panel		19 ⁹ / ₁₆ (48.8)	73 ⁷ / ₁₆ (185.9)
2 Panel, 1 T-Post		20 ³ / ₈ (52.4)	73 ³ / ₈ (187.1)
1 Bifold		19 ⁹ / ₁₆ (48.8)	53 ⁷ / ₁₆ (135.1)
1 Panel, 1 Bifold		28 ⁵ / ₁₆ (72.0)	89 ⁵ / ₁₆ (226.9)
1 Panel, 1 Bifold, 1 T-Post		29 ⁷ / ₁₆ (75.3)	110 ⁷ / ₁₆ (281.0)
3 Panel, 2 T-Posts		30 ¹³ / ₁₆ (78.3)	111 ¹³ / ₁₆ (284.1)
2 Bifold		37 ⁷ / ₁₆ (94.5)	105 ⁷ / ₁₆ (267.2)
2 Bifold, 1 T-Post		38 ³ / ₈ (97.5)	106 ³ / ₈ (270.2)
4 Panel, 1 T-Post		38 ³ / ₈ (97.5)	146 ³ / ₈ (371.8)
4 Panel, 2 T-Posts		39 ³ / ₈ (100.1)	147 ³ / ₈ (374.4)
4 Panel, 3 T-Posts		40 ³ / ₈ (102.6)	148 ³ / ₈ (376.9)

Specialty Styles

Corner Windows

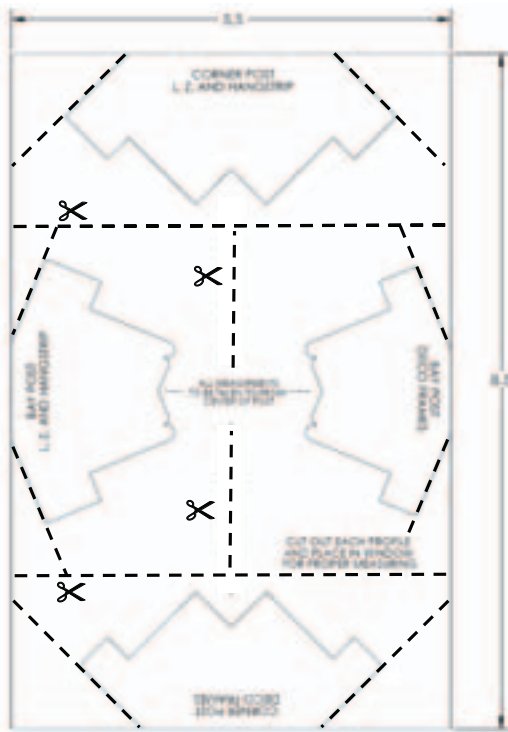

Frame (footprint) template available. Cut out individual pieces for use during measure.

- 90° (degrees) angled corners only
- Framed configurations offered:
 - 2-sided framed configurations only
- Unframed configurations offered
 - Direct mount and hang strip
- All frame styles available except tilt-out Z, narrow colonial L, extended standard L, bullnose Z, extended narrow colonial L, craftsman Z, and deco and sill cap
- T-posts are available (see parameters below)
- No buildout is available
- 2½" (6.4 cm), 3½" (8.9 cm), and 4½" (11.5 cm) louvers

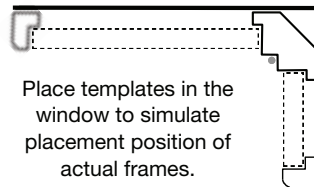

Place templates in the window to simulate placement position of actual frames.

Measuring Tips

1. For direct mount, hang strip, and Z-frame: Order WO. Measure from inner edge of window to center of corner post.
2. For L-frame and deco frame: Order F-F. Measure from outside edge of outer frame to center of corner post.

Both measure formats use the (front) center of the corner post as reference points (see small dots on diagram above).

Available Panel Configurations by Window Locations for Corner Windows

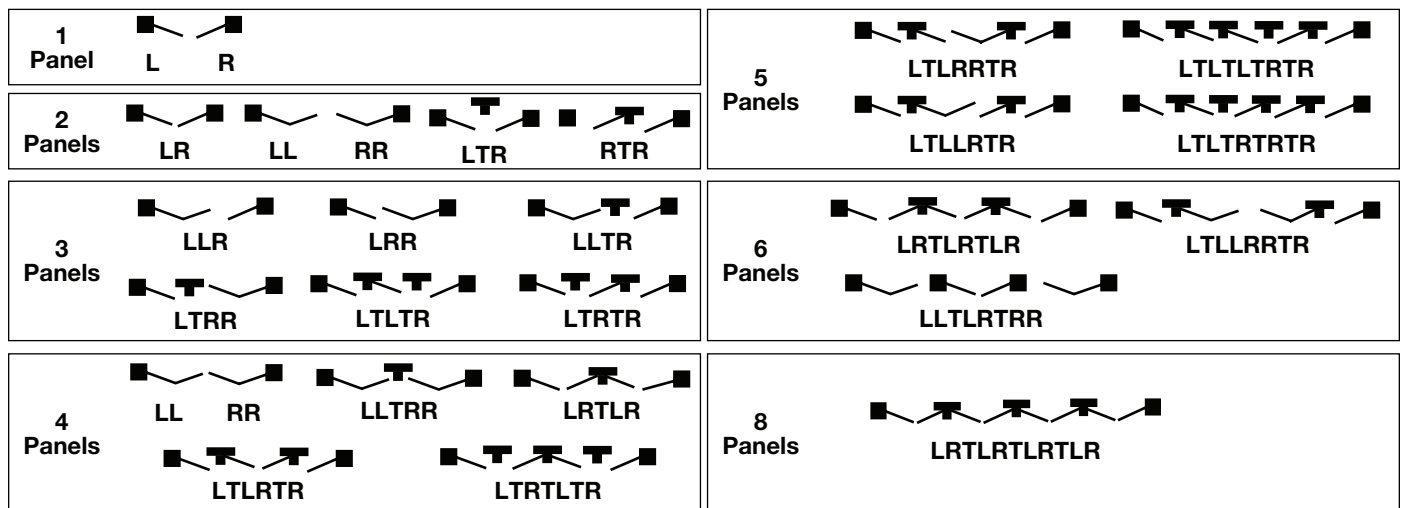

Specialty Styles

Corner Windows

Minimum and Maximum Order Width Sizes by Fold Pattern by Frame Type

Panel Configurations Available for Both Windows of the Corners		Direct Mount Hang Strip		Z-Frames		3" (7.7 cm) Traditional Deco Frame		3½" (8.9 cm) Curved/Beaded/Deco Frame		L-Frames	
		Order WO		Order WO		Order F-F Size		Order F-F Size		Order F-F Size	
		Minimum inches (cm)	Maximum inches (cm)	Minimum inches (cm)	Maximum inches (cm)	Minimum inches (cm)	Maximum inches (cm)	Minimum inches (cm)	Maximum inches (cm)	Minimum inches (cm)	Maximum inches (cm)
1 Panel		9 ¹³ / ₁₆ (25.0)	36 ¹³ / ₁₆ (93.6)	10 ⁹ / ₁₆ (26.9)	37 ⁹ / ₁₆ (95.5)	12 ¹ / ₂ (30.8)	39 ¹ / ₈ (99.4)	12 ¹³ / ₁₆ (32.6)	39 ¹³ / ₁₆ (101.2)	10 ¹³ / ₁₆ (27.5)	37 ¹³ / ₁₆ (96.1)
2 Panel		18 ⁷ / ₁₆ (47.2)	72 ⁷ / ₁₆ (184.4)	19 ⁹ / ₁₆ (49.7)	73 ⁹ / ₁₆ (186.9)	20 ¹³ / ₁₆ (52.9)	74 ¹³ / ₁₆ (190.1)	21 ⁷ / ₁₆ (54.5)	75 ⁷ / ₁₆ (191.7)	19 ⁹ / ₁₆ (49.7)	73 ⁹ / ₁₆ (186.9)
2 Panel, 1 T-Post		20 (50.8)	74 (188.0)	20 ³ / ₄ (52.8)	73 ³ / ₈ (186.4)	22 ⁵ / ₁₆ (56.7)	75 ⁵ / ₁₆ (191.5)	22 ¹⁹ / ₁₆ (58.0)	75 ¹⁵ / ₁₆ (192.9)	21 (53.4)	74 (188.0)
1 Bifold		18 ⁷ / ₁₆ (47.2)	52 ⁵ / ₁₆ (133.6)	19 ⁹ / ₁₆ (49.7)	52 ⁹ / ₁₆ (133.6)	20 ⁷ / ₈ (53.1)	54 ⁷ / ₈ (139.4)	21 ⁷ / ₁₆ (54.5)	55 ⁷ / ₁₆ (140.9)	19 ⁹ / ₁₆ (49.7)	53 ⁹ / ₁₆ (136.1)
1 Panel, 1 Bifold		27 ¹ / ₄ (69.3)	88 ¹ / ₄ (224.2)	28 ⁵ / ₈ (75.3)	89 ⁵ / ₈ (227.7)	30 ³ / ₁₆ (76.7)	91 ³ / ₁₆ (231.7)	30 ⁷ / ₈ (78.5)	91 ⁷ / ₈ (233.4)	28 ³ / ₄ (71.8)	89 ³ / ₄ (226.7)
1 Panel, 1 Bifold, 1 T-Post		28 ¹ / ₄ (71.8)	89 ¹ / ₄ (226.7)	29 ⁵ / ₈ (75.3)	90 ⁵ / ₈ (230.2)	31 ³ / ₁₆ (79.3)	92 ³ / ₁₆ (234.2)	31 ⁷ / ₈ (81.0)	92 ⁷ / ₈ (236.0)	29 ¹ / ₄ (74.3)	90 ¹ / ₄ (229.3)
3 Panel, 2 T-Post		29 (73.7)	110 ¹ / ₁₆ (280.9)	30 ¹⁵ / ₁₆ (78.6)	111 ¹⁵ / ₁₆ (284.4)	32 ¹ / ₂ (82.6)	113 ¹ / ₂ (288.3)	33 ³ / ₁₆ (84.3)	114 ³ / ₁₆ (290.1)	30 ³ / ₁₆ (77.7)	111 ³ / ₁₆ (283.4)
2 Bifold		36 ⁷ / ₁₆ (92.9)	104 ⁷ / ₁₆ (265.6)	37 ¹¹ / ₁₆ (95.8)	105 ¹¹ / ₁₆ (268.5)	39 ¹ / ₄ (99.7)	108 ¹ / ₁₆ (276.8)	39 ⁹ / ₁₆ (101.5)	108 ⁹ / ₁₆ (276.8)	37 ⁹ / ₁₆ (94.8)	105 ⁹ / ₁₆ (267.5)
2 Bifold, 1 T-Post		37 ¹ / ₈ (94.3)	105 ¹ / ₈ (267.1)	38 ¹ / ₂ (97.8)	106 ¹ / ₂ (270.6)	40 ¹ / ₁₆ (101.8)	108 ¹ / ₁₆ (274.5)	40 ³ / ₄ (103.6)	108 ³ / ₄ (276.3)	38 ¹ / ₄ (97.2)	106 ¹ / ₄ (269.9)
4 Panel, 1 T-Post		37 ¹ / ₈ (94.3)	145 ¹ / ₈ (368.7)	38 ¹ / ₂ (97.8)	146 ¹ / ₂ (372.2)	40 ¹ / ₁₆ (101.8)	148 ¹ / ₁₆ (376.1)	42 ³ / ₄ (108.6)	148 ³ / ₄ (377.9)	38 ¹ / ₄ (97.2)	146 ¹ / ₄ (371.5)
4 Panel, 2 T-Posts		38 ⁷ / ₁₆ (97.7)	146 ⁷ / ₁₆ (372.0)	39 ¹³ / ₁₆ (101.2)	147 ¹³ / ₁₆ (375.5)	41 ¹ / ₈ (105.1)	149 ¹ / ₈ (379.5)	42 ¹ / ₁₆ (106.9)	150 ¹ / ₁₆ (381.2)	39 ¹³ / ₁₆ (100.2)	147 ¹³ / ₁₆ (374.5)
4 Panel, 3 T-Posts		39 ³ / ₄ (101.0)	147 ³ / ₄ (375.3)	41 ¹ / ₈ (104.5)	149 ¹ / ₈ (378.8)	42 ¹ / ₁₆ (108.5)	150 ¹ / ₁₆ (382.8)	43 ³ / ₈ (110.2)	151 ³ / ₈ (384.5)	40 ³ / ₄ (103.6)	148 ³ / ₄ (377.9)
3 Panel, 1 Bifold, 2 T-Posts		47 ⁵ / ₁₆ (121.0)	162 ⁵ / ₁₆ (413.1)	50 ¹³ / ₁₆ (129.1)	165 ¹³ / ₁₆ (421.2)	55 ⁵ / ₁₆ (140.2)	170 ⁵ / ₁₆ (432.3)	57 (144.8)	172 (436.9)	50 ⁵ / ₈ (128.6)	165 ⁵ / ₈ (420.7)
5 Panel, 4 T-Posts		49 ¹⁵ / ₁₆ (126.9)	184 ¹⁵ / ₁₆ (469.8)	53 ¹ / ₈ (135.0)	188 ¹ / ₈ (477.9)	56 ¹ / ₈ (142.6)	192 ¹ / ₈ (488.0)	58 ⁹ / ₁₆ (148.2)	193 ⁹ / ₁₆ (491.1)	52 ¹⁵ / ₁₆ (134.5)	187 ¹⁵ / ₁₆ (477.4)
2 Panel, 2 Bifold, 2 T-Posts		56 ³ / ₁₆ (142.8)	178 ³ / ₁₆ (452.6)	57 ⁹ / ₁₆ (146.3)	179 ⁹ / ₁₆ (456.1)	59 ¹ / ₈ (150.2)	181 ¹ / ₈ (460.1)	59 ⁹ / ₁₆ (152.0)	181 ⁹ / ₁₆ (461.9)	57 ⁹ / ₁₆ (146.9)	179 ⁹ / ₁₆ (456.8)
6 Panel, 2 T-Posts		56 ³ / ₁₆ (142.8)	218 ³ / ₁₆ (554.2)	57 ⁹ / ₁₆ (146.3)	219 ⁹ / ₁₆ (557.7)	59 ¹ / ₈ (150.2)	221 ¹ / ₈ (561.7)	59 ⁹ / ₁₆ (152.0)	221 ⁹ / ₁₆ (563.5)	57 ⁹ / ₁₆ (146.9)	219 ⁹ / ₁₆ (556.8)
8 Panel, 3 T-Posts		75 ¹ / ₄ (191.2)	291 ¹ / ₄ (739.8)	76 ³ / ₈ (194.7)	292 ³ / ₈ (743.3)	78 ³ / ₁₆ (198.6)	294 ³ / ₁₆ (747.3)	78 ⁷ / ₁₆ (200.4)	294 ⁷ / ₁₆ (749.0)	76 ¹ / ₄ (193.7)	292 ¹ / ₄ (742.4)

General Information

Definitions

Aligning Catch—Concealed magnet and catch plate on back top side of the café panels. Used to provide a flush panel alignment.

Astragal—Covers clearance gap between two panels for the purpose of eliminating light gap. Integral to stile.

Bifold—Two panels are hinged together to lie flush against the window or wall.

Box-Out Frame—Track system frame option that creates an outside mount application consisting of a three-sided frame with or without a decorative valance.

Buildout—Used in conjunction with L-frames and deco frames to move panels away from window, allowing additional clearance for louvers to open.

Bypass Track System—Two or more panels on two overhead track that slide and pass each other.

Café Style Shutters—Cover the lower portion of an opening. They can be made to any height within product specifications.

Direct Mount—Mounting the shutter panels directly to the window casing.

Divider Rail—A rail that divides the shutter panel into two horizontal sections. It is used to add strength to a tall panel or add a decorative touch.

Double Mouse Hole—Recess on the top and bottom rail allowing for the louvers to be completely closed in either direction. Close in upward position for optimal closure.

Guide—Component part used with bypass configurations to lead the panels so that they do not project into the room.

Hang Strip—The mounting frame that is used for inside mount shutter panels.

Inside Mount—A shutter that is mounted on the inside of an opening.

Light Block—Square rail that blocks light between the window sill and the shutter panel, used with direct mount, hang strip, 2-sided frames, and 3-sided frames.

Louvers—The movable fins inside the shutter panel.

Mouse Hole—Recess in the top rail of the panel that the lift rod rests in when the louvers are completely closed. Standard is single mouse hole.

Outside Mount—A shutter that is mounted on the outside of an opening.

Panel—The part of the shutter that consists of a set of louvers, two rails, and two stiles.

Rabbet Stile—A special cut on the stiles that allows the panels to overlap. Helps control light penetration between the panels.

Rails—The top and bottom solid portions of a panel that frame the louvers.

Square Window—Diagonal measurements must be within ¼" (0.7 cm) difference. Windows that are not square will need to have the shutter mounted to the outside of the window opening.

Stack Back—Configuration that allows the panels of the bypass or bifold track system to completely slide beyond the window opening.

Stile—The vertical portion of the panel frame to which the louvers are anchored.

Tilt Bar—A vertically mounted bar located on the front of the shutter.

T-Post—A vertical post that divides the shutter into multiple sections (used with wider shutters).

Window Depth—The distance from the surface of the wall to the closest part of the window (examples: latch, crank, frame, etc.).

General Information

Care Instructions

Adjusting Tension System

The wood shutters that you have purchased include a built-in tension system to allow for adjustments. If you find that your louvers are too loose or are not functioning to your standards, simply follow these instructions. Open the panels fully; on each side of the panel you will find a tension adjustment screw hole. With a small screwdriver, gently turn the screw 1-2 turns (left to loosen, right to tighten the tension) to your desired resistance level on each side of the panel. Repeat this process for each panel if necessary.

Wood Shutters

Occasional light vacuuming with a brush attachment should keep shutters clean. For minor soiled areas, clean with warm water using a clean cotton cloth. Dry with a second clean cotton cloth. For more severe soiling, use a mild detergent diluted to a 5% solution with room temperature water. Clean with a cotton cloth. Wipe area with clear water to remove any detergent residue and dry with cotton cloth.

Price Charts and Options Pricing

Wood Shutter Pricing

Frame Type	Painted	Stained
Hang Strip, Direct Mount	\$53.50 per square foot	\$59.70 per square foot
L-Frames (Frame-to-Frame)	\$55.00 per square foot	\$61.30 per square foot
Z-Frames, Tilt-Out Z-Frame (Window Opening)	\$56.00 per square foot	\$62.30 per square foot
Deco Frames (Frame-to-Frame)	\$56.00 per square foot	\$62.30 per square foot
Bifold/Bypass Track Systems	\$57.70 per square foot	\$62.80 per square foot

Additional Surcharges

Café Shutter with 4-Sided Frame5%
Hide-a-Tilt™ Bar10%
Bifold or Bypass Box-Out (Outside Mount Only)*15%
Bypass Decorative Valance	No charge
Bifold or Bypass Stack Back Surcharge*5%
Wood Corner Post and Bay Post Surcharge	\$61.25
Astragal Stile	No charge
Café Aligning Catch	No charge
Custom Color (Flat Fee Per Color Per Order)	\$149.00 net
Stainless Steel Hinge5%
Wood Sill Cap10%

*Calculate the overall square footage of the bypass or bifold panels. Use the overall square footage to calculate the surcharge for the box-out or stack back surcharge.

Wood Specialty Surcharges

How to Calculate Specialty Retail Price: Calculate the overall square footage of the specialty, then multiply times the base price of the frame type chosen, and add the surcharge from chart below. Apply dealer discount to the calculated retail price.

Add Surcharge to Shutter Price

	Hang Strip/ Direct Mount	Z-Frame	L-Frame	Deco Frame
Sunburst Arches	\$500	\$625	\$575	\$625
Quarter Sunburst Arches	500	625	575	625
Arch Panel Shutters	500	625	575	625
Angle Panel Shutters	500	625	575	625
French Doors**	N/A	N/A	500	N/A

**French doors only available with L-frame.

NOTE: ¼ arches, angles, ½ angles, and arch/angle panels with a T-post will be made in Asia with an 8-10 week lead time.

The following frames are not available for ¼ arch panel, ½ angle, or any arch or angle panel with T-post:

- Narrow colonial L-frame
- 2½" (6.4 cm) and 3½" (8.9 cm) extended narrow colonial L-frames
- Bullnose Z-frame
- 2½" (6.4 cm) and 3½" (8.9 cm) extended standard L-frames
- Craftsman Z and craftsman deco frames
- Tilt-out Z-frame
- Craftsman Z-frame
- Craftsman deco frame



Graber is a brand of Springs Window Fashions, the Best Experience Company 

Graber and the Graber logo are registered trademarks of Springs Window Fashions, LLC.

19-0220-06 (07/17) 17-5781|S17-5089