

TRADEWINDS® NATURAL SHADES AND DRAPES

Table of Contents

Features

Natural Shades, Natural Drapes	2
Nature's Beauty of Natural Shades	3
Material Styles and Information: Natural Shades and Natural Drapes	4

Size Considerations

Natural Shades, Depth Requirements for Inside Mount, Natural Drapes, Depth Requirements for Inside Mount	5
--	---

Options

Summary	6
Cord Lift: Natural Shades, Continuous-Loop Lift: Natural Shades, Cordless Lift: Natural Shades	7
Motorized Lift: Natural Shades, Motorized Quick Reference, Bottom Up/Top Down: Natural Shades	8
Natural Drapes Control Options, Fullness: Natural Drapes	9
Liners: Natural Shades and Natural Drapes, Edge Banding and Colors: Natural Shades and Natural Drapes	10
Cut-outs: Natural Shades, Angle Top: Natural Shades	11
Multiple Shades on One Headrail: Natural Shades	12
Bay and Corner Windows	13
Valance: Natural Shades, Valance: Natural Drapes, Deco-Trim Valance or Hems: Natural Shades	14
Valance Returns for Standard Valances, Valance: Premiere Valance Only: Natural Shades and Natural Drapes	15
Accent Gimp: Natural Shades, Deco-Pocket Hem: Natural Shades	16
Turned Headrail: Natural Shades	17

General Information

Stack Charts: Natural Shades, Stack Height: Natural Shades	18
Stack Charts: Natural Drapes, Natural Drapes 10% Standard Fullness Stack Chart, Natural Drapes 60% Fullness Stack Chart	19
Natural Shades Product Detail	20
Natural Shades Looped Roman Product Detail	21
Natural Shades Cordless Lift Product Detail, Natural Shades Continuous-Loop Lift Product Detail	22
Natural Drapes Product Detail	23

Price Charts and Options Pricing

Price Group A: Lipo, Revelry	25
Price Group B: Chencun, Escape, Majian, Serenity, Toushan II	26
Price Group C: Inan, Moniz, Yunnan	27
Price Group D: Amour, Boardwalk, Majuro	28
Price Group E: Beachfront, Meilin, Satterra, Terrestrial, Zishan	29
Price Group F: Azores, Madeira, Merino, Paralian	30
Price Group G: Lipo, Revelry	31
Price Group H: Chencun, Escape, Majian, Serenity, Toushan II	32
Price Group I: Inan, Moniz, Yunnan	33
Price Group J: Amour, Boardwalk, Majuro	34
Price Group K: Azores, Madeira, Merino, Paralian	35
Options Pricing, Natural Shade Options, Natural Drape Options, Premiere Valance Only	36

GRABER®

UNITED STATES PRICE LIST • FEBRUARY 2019

Features

Natural Shades



Graber® Tradewinds® Natural Shades are crafted from bamboo reed, slit bamboo, sisal, grass, and jute materials. They add natural color, texture, and dimension to your windows and create a comfortable atmosphere of casual elegance or simple sophistication.

- Standard Roman, old style Roman, or looped Roman shade designs
- Wide selection of colors, textures, and unique weaves
- Cord lift, cordless lift, continuous-loop lift, bottom up/top down, and motorized lift available
- 6" (15.3 cm) valance with horizontally oriented material is standard on shades except for motorized lift and continuous-loop lift
- 9" (22.9 cm) valance with horizontally oriented material is standard on shades with motorized lift and continuous-loop lift
- Premiere valance is standard on shades with cordless lift

Natural Drapes



- Natural drapes feature the rolling qualities of drapery in vertically oriented natural shade material
- Features wand control, corded, or in single or split stack
- Choose from standard fullness (when closed, waves slightly) or a 60% fullness (when closed, features drapery-like appearance)
- Premiere valance with vertical material orientation included with drape
- Shade without valance (optional, no additional charge) is not recommended, as aluminum headrail and hardware will be visible; suggested when ordering wood cornice
- Valance and returns will extend $\frac{3}{8}$ " (1.0 cm) per side on inside mount, and $\frac{1}{16}$ " (1.5 cm) to $\frac{5}{8}$ " (1.6 cm) per side on outside mount, further than drape width
- Edge banding required on the drapes and valance
 - Select from 1" (2.6 cm) or 2" (5.1 cm) solid edge banding for the drapes
 - Valance uses matching 1" (2.6 cm) edge banding on vertical orientation, up to 2" (5.1 cm) on horizontal orientation

NOTE: Not available with Beachfront, Meilin, Satterra, Terrestrial, and Zishan.

Features

Nature's Beauty of Natural Shades



There is simply no substitute for the beauty of the materials used in natural shades. The colors and textures of bamboo, reeds, grass, and jute have a distinct character and one-of-a-kind look that synthetic materials can't match.

Unique Characteristics of Natural Shades

Asymmetry

Materials used in natural shades are naturally grown and harvested. Variations in shape, thickness, texture, and grain are to be expected from Mother Nature. While adding personality, these variations create asymmetry in the weave that may alter the appearance of the finished shades. Specifically, you may notice:

- **Uneven Spacing or Gaps**—Differences in bamboo or reed shapes and thicknesses can create uneven spacing or gaps in the weave
- **Pattern Changes or Gaps**—The varying thickness of grassy materials, tied knots, and splices can create visual disruptions in the weave pattern or gaps in the weave
- **Length Differences**—Variations in thickness, bamboo joints, or reed sizes can create length differences from both sides of the shades
- **Bowing or Arching**—Different drying rates of bamboo fibers can create a bowing or arching effect on the finished shades

To minimize variations, all materials used are hand selected to comply with strict specifications. These variations are not considered flaws, but rather normal characteristics expected from naturally grown materials.

Color

Evolving with age, the color of bamboo, reeds, grasses, jute, and other natural materials will change slightly. Depending on material composition, they may lighten or darken due to direct sunlight or other climatic conditions. Uncolored or natural materials will experience the most color shift, changing from a green color at harvest to a yellow-brown color over three to six months. Color matching of shades cannot be guaranteed as these are natural reactions to aging.

With character, however, comes inherent natural properties that may influence the appearance of the finished shade. Recognizing and understanding the characteristic traits of natural materials provides more satisfaction and enjoyment once you know why each shade is truly unique!

Stretching/Sagging

The natural elasticity of yarns, combined with the weight of the woven material, may cause shades to stretch or sag from 1" (2.6 cm) to 1½" (3.9 cm), and sliding panels to stretch or sag from 1" (2.6 cm) to 2" (5.1 cm) after installation. This is particularly noticeable on inside mount shades or shades that extend from ceiling to floor. Ordering shades shorter than needed will help compensate for stretching over time. Adding edge banding not only gives your shades a truly personal touch, but also helps to control stretching.

Tips

During the shipping process, the natural material may have shifted slightly due to its woven construction, causing slight shortening or uneven edges.

Height—If after installation, the shades are slightly shorter than ordered, grasp the bottom of the shades and gently pull to stretch to the preferred height. Some materials will also stretch by themselves over time.

Uneven Edges—Lightly tap edge of the shades with a flat edge (for example, a ruler) until even.

Frayed Edges—If threads come loose near the edges, use a sharp scissors to trim off stray threads.

Light Control and Privacy

Sheer—Allows the most amount of light into the room for a minimum amount of privacy and a view to the outside. Objects in the room can be seen quite clearly through shades.

Light Filtering—Allows light to gently filter through and provides privacy. Images and shapes may be seen through these shades.

Natural shades may have variations and visual inconsistencies in color, weave, grain, and texture. They may also crack or split, twist or bow, shrink or stretch, and change color over time due to aging, direct sunlight, or other climatic conditions. These unique characteristics are inherent in natural materials and are not considered defects in material or workmanship. Exact color matches cannot be guaranteed.

Features

Material Styles and Information: Natural Shades and Natural Drapes

Style Name	Color Name	Color Number	Maximum Fabric Width inches (cm)	Light Control and Privacy*	Material Content	Shades Price Group	Drapes Price Group	Sliding Panels Price Group**
Amour	Radiant Pearl	00001 00116	96 (243.9)	Light filtering	Bamboo reed	D	J	H
Azores	Snow Suede	35060 35061	96 (243.9)	Light filtering	Wood	F	K	J
	Sycamore	35062						
	Carob	35063						
Beachfront	Tidepool	60040	96 (243.9)	Sheer	Bamboo reed	E	N/A	I
	Surf Thatch	60041 60042						
Boardwalk	Pier	15968	96 (243.9)	Sheer to light filtering	Bamboo reed, grass, jute	D	J	H
Chencun	White	60417	96 (243.9)	Sheer to light filtering	Slit bamboo, bamboo reed	B	H	F
	Appaloosa	00846						
Escape	Forest Island	25601 25602	96 (243.9)	Light filtering	Bamboo reed	B	H	F
	Inan	Umber	04858	96 (243.9)	Sheer to light filtering	Slit bamboo, bamboo reed, jute rope	C	I
Lipo	Earhtones	06793	96 (243.9)	Sheer to light filtering	Slit bamboo, bamboo reed, jute rope	A	G	E
	Ambrosia	06702						
	Java	06703						
	Tahoe	60705						
Madeira	Brunette	65010	96 (243.9)	Light filtering	Bamboo reed	F	K	J
	Wolf	65011						
Majian	Toffee	32296	96 (243.9)	Sheer to light filtering	Bamboo reed	B	H	F
	Driftwood	32445						
Majuro	Daisy	45070	96 (243.9)	Light filtering	Bamboo reed, jute	D	J	H
	Cattail	45071						
	Trail	45072						
	Stonybrook	45073						
Meilin	Onyx	51227	96 (243.9)	Light filtering	Jute, jute braid, bamboo reed	E	N/A	I
	Chroma	51201						
Merino	Burgos	50503	96 (243.9)	Sheer to light filtering	Bamboo reed, jute, jute braid	F	K	J
	Sevilla	55506						
	Grenada	55507						
	Belize	55508						
Moniz	Finland	05080	96 (243.9)	Light filtering	Bamboo reed, grass rope	C	I	G
	Peru	05081						
	Austria	05083						
	Belgium	05084						
Paralian	Mink	25050	96 (243.9)	Light filtering	Bamboo, paper yarn	F	K	J
	Sand Dollar	25051						
	Otter	25052						
Revelry	Birdnest	80045	96 (243.9)	Sheer to light filtering	Bamboo reed	A	G	E
	Dusk	80743						
	Dove	80745						
Saterra	Azure	03269	96 (243.9)	Sheer	Jute	E	N/A	I
	Terrain	03370						
	Veridian	03371						
Serenity	Haze	11502	96 (243.9)	Light filtering	Bamboo reed	B	H	F
	Dover White Coastline	15700 15702						
Terrestrial	Alpaca	28001	96 (243.9)	Light filtering	Grass	E	N/A	I
	Camel	28003						
Toushan II	Taupe	63659	96 (243.9)	Light filtering	Slit bamboo, bamboo reed	B	H	F
	Mocha	63759						
Yunnan	Arctic Seal	19585	96 (243.9)	Light filtering	Slit bamboo, bamboo reed, grass rope	C	I	G
	Sky	19586						
	Rocky Shore	19587						
Zishan	Auburn	43689	96 (243.9)	Light filtering	Grass, bamboo reed	E	N/A	I
	Stardust	43731						
	Toast	43734						
	Feather	30735						
	Hut	30736						
	Hula	30737						

*Privacy and light control without liner; addition of privacy or room-darkening liner improves privacy and light control.

**See sliding panels cost and product reference guide for more information.

***All fabrics have similar streetside appearance.



N/A = Not available

Size Considerations

Natural Shades

	Width		Height	
	Minimum inches (cm)	Maximum inches (cm)	Minimum inches (cm)	Maximum inches (cm)
Standard Roman Old Style Roman	10 (25.4) outside mount 10½ (26.7) inside mount	96 (243.9) single 144 (365.8) multiple 72 (182.9) with deco-pocket accent rod	12 (30.5) 18 (45.8) with deco-pocket hem	120 (304.8)
Looped Roman	12 (30.5) outside mount 12½ (31.8) inside mount			
Bottom Up/Top Down	14 (35.6) outside mount 14½ (36.9) inside mount	96 (243.9) single 144 (365.8) multiple	12 (30.5)	108 (274.4)
Continuous-Loop Lift	24 (61.0) outside mount 24½ (62.3) inside mount			
Cordless Lift	12 (30.5) outside mount 12½ (31.8) inside mount	144 (365.8)	12 (30.5)	See price charts
Multiple Shades on One Headrail	20½ (52.1) exact			
12 volt Motorized Lift	18 (45.8) outside mount 18½ (47.0) inside mount	Determined by square feet; see motorization price list for more details.		
24 volt Motorized Lift	22 (55.9) outside mount 22½ (57.2) inside mount			

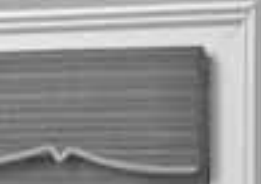
Depth Requirements for Inside Mount



Type of Shade	Headrail Dimensions inches (cm)				
		Minimum Depth Mount inches (cm)	Flush with Casing inches (cm)	Minimum Depth Mount inches (cm)	Flush with Casing inches (cm)
Standard, Old Style, and Looped Roman Bottom Up/Top Down	5/8 x 1½ (1.6 x 3.9)	¾ (2.0)	¾ (2.0)	27/16 (6.2)	1 1/8 (4.2) standard Roman 1 (2.6) old style Roman
Cordless Lift	1½ x 2 1/8 (3.9 x 5.4)			4 1/4 (10.8)	
Continuous-Loop Lift Motorized Lift	5/8 x 2 1/4 (1.6 x 5.8)			3 3/16 (8.1)	
Turned Headrail	1½ x 5/8 (3.9 x 1.6)				

Natural Drapes

	Width		Height	
	Minimum inches (cm)	Maximum inches (cm)	Minimum inches (cm)	Maximum inches (cm)
Standard Drapery Fullness	16 (40.7) outside mount	192 (487.7)	20 (50.8)	96 (243.9)
60% Drapery Fullness	17 (43.2) inside mount			

NOTE: Minimum surface for outside mount: 3" (7.7 cm).

Depth Requirements for Inside Mount

Headrail Dimensions inches (cm)					
		Minimum Depth Mount inches (cm)	Valance Flush with Casing inches (cm)	Minimum Depth Mount inches (cm)	Valance Flush with Casing inches (cm)
Cord Control = 7/8 x 1 1/8 (2.3 x 4.8)	Standard drapery fullness	3 3/8 (9.3)	8 (20.4)	3 3/8 (9.3)	8 (20.4)
	60% drapery fullness	4 1/2 (11.5)			
Wand Control = 7/8 x 1 1/2 (2.3 x 3.9)	Standard drapery fullness	3 3/8 (9.3)	8 (20.4)	3 3/8 (9.3)	8 (20.4)
	60% drapery fullness	4 1/2 (11.5)			

Options

Summary

The following is a list of options for natural shades. Most options are available in all styles and colors. Limitations will be based on fabric width and fabric type. See detailed descriptions on the following pages.

	Standard Roman	Old Style Roman	Looped Roman
Cord Lift	•	•	•
Cordless Lift	•		
Continuous-Loop Lift	•	•	•
Motorized Lift	•	•	
Bottom Up/Top Down	•		
Angle Top	•		
Cut-Outs	•	•	
Multiple Shades on One Headrail	•	•	•

No Charge Options: Natural Shades

- Bay or corner window
- Hold down brackets[†]
- 3½" (8.0 cm) projection brackets
- 2" (5.1 cm) short returns
- Turned headrail
- Valances
 - 6" (15.3 cm) standard
 - 6" (15.3 cm) premiere (standard with cordless lift)
 - 9" (22.9 cm) standard (standard with continuous-loop lift and motorized lift)
 - No valance (always optional)

Surcharge Options: Natural Shades

- Control types
 - Cordless lift
 - Motorized lift
 - Continuous-loop lift
- Bottom up/top down
- Multiple shades on one headrail
- Specialty shades
 - Angle top
- Cut-outs
- Liners
- Edge banding*
- Decorative cord cleats
 - Antique brass
 - Solid brass
- Cord winder
- Wood cornices/valances
- Valances
 - 9" (22.9 cm) standard
 - 6" (15.3 cm) premiere
 - Horizontal or vertical orientation
 - 9" (22.9 cm) premiere
 - Horizontal or vertical orientation
 - 9" (22.9 cm) deco-trim valance
- Deco-trim hem
- Deco-pocket hem

No Charge Options: Natural Drapes

- Control types
 - Wand control
 - Cord control
- Ceiling mount brackets
- Edge banding*
- Valances
 - 6" (15.3 cm) premiere (standard with natural drapes)
 - Horizontal or vertical orientation
 - 9" (22.9 cm) premiere
 - Horizontal or vertical orientation
 - No valance (always optional)
- Fullness: standard (slight wave when closed)

Surcharge Options: Natural Drapes

- Fullness: 60% (drapery-like appearance when closed)
- Liners
- Wood cornices/valances

*Edge banding: Optional on shades or valances with horizontally oriented material; required on valances with vertically oriented material.

†Hold down brackets: Only available at time of order. Cannot be retrofitted. Not available with edge banding, deco-trim, or deco-pocket hem.

Options

Cord Lift: Natural Shades



- **No charge**
- Color coordinated cord and tassels
- Controls can be on the right or left of the shade
- Safety cord cleat provides the ability to keep the cord out of reach for children and pets
- Standard cord length is approximately $\frac{1}{3}$ of the shade height
- 6" (15.3 cm) minimum control length
- Special length cords available as an option—no charge

Continuous-Loop Lift: Natural Shades



Cord shown; bead chain is used on shades over 30 square feet (2.8 square meters)

- **For surcharge, see options pricing**
- Available on standard Roman, old style Roman, and looped Roman shades
- Continuous-loop lift control raises and lowers the shade and is color coordinated to the shade material
 - Shades under 30 square feet (2.8 square meters) have color coordinated cord
 - Shades over 30 square feet (2.8 square meters) will use a nickel-plated steel bead chain loop in place of cord
 - When ordering different size shades for the same room, specify if bead chain is preferred for all shades
- Allows for easier operation of larger shades
- 9" (22.9 cm) valance is standard with the continuous-loop lift option; (6" (15.3 cm) valance not available)
- Not available with bottom up/top down or angle top shades

Cordless Lift: Natural Shades



- **For surcharge and size restrictions, see price charts**
- Available on standard Roman shades
- Cordless lift shades offer a safer alternative for homes with children and pets
- Easy to use: to lower shade, pull down; to raise shade, simply guide the shade into the desired location by gently lifting the hemrail
- Not available with cut-outs, bottom up/top down, deco-trim, or deco-pocket hems, or angle top shades
- Premiere valance included at time of order; see valance options for available styles

For Shades Less Than 17" (43.2 cm) in Width

If Finished Shade Width is inches (cm)	Maximum Height of Shade is inches (cm)
Equal to 12 (30.5) but less than 12½ (31.8)	23¼ (59.1)
Equal to 12½ (31.8) but less than 13 (33.1)	29½ (75.0)
Equal to 13 (33.1) but less than 13½ (34.3)	35¾ (90.9)
Equal to 13½ (34.3) but less than 14 (35.6)	42½ (107.0)
Equal to 14 (35.6) but less than 14½ (36.9)	48¾ (122.9)
Equal to 14½ (36.9) but less than 15 (38.1)	54¾ (138.8)
Equal to 15 (38.1) but less than 15½ (39.4)	61 (155.0)
Equal to 15½ (39.4) but less than 16 (40.7)	67¼ (170.9)
Equal to 16 (40.7) but less than 16½ (42.0)	73½ (186.7)
Equal to 16½ (42.0) but less than 17 (43.2)	79¾ (202.6)
Equal to 17 (43.2) or more	See price charts

Options

Motorized Lift: Natural Shades



Refer to motorization price list for additional options, sizing, and pricing.

Features

- Window treatments can be operated from virtually anywhere in the home
- Provides easy operation of hard-to-reach or large window coverings
- Efficiently manages energy (heat gain and loss)
- Operate multiple window treatments simultaneously or individually
- A safer alternative to traditional cords used to operate window coverings; ideal for homes with children and pets
- Easily integrated with home automation systems
- Low-voltage motorization requires no costly electrical hard-wiring

Details

- Motor located on right side underneath the wooden headrail attached with R-series bracket and tube
- Multiple controls and power options available
- Available on standard Roman and old style Roman
- Available with 9" (22.9 cm) valance only; no valance is optional
- Multiple shades on one headrail available; each panel will have a motor and power source
- Available with bottom corner and bottom center cut-outs
- Not available with bottom up/top down or specialty shapes
- Not available with hold down brackets

NOTE: Motorization components and accessories have a five-year limited warranty, excluding batteries.

Motorized Quick Reference

	Yes	No
Standard Roman	•	
Old Style Roman	•	
Looped Roman		•
Bottom Up/Top Down		•
Angle Top		•
Multiple Shades on One Headrail	•	

Bottom Up/Top Down: Natural Shades



For surcharges, see options pricing

Features

- Allows shades to be raised from the bottom up like a conventional shade, or operated from the top down
- Provides privacy while still allowing light in from the top of the window
- Ideal for bedrooms

Details

- Edge banding and liner options available
 - Liner recommended for valances
- Right control will raise the bottom; left control will lower the top (standard control locations only)
- 4" (10.2 cm) seclusion strip (street side) will be applied on blinds that are inside mount to conceal the headrail component (not available on outside mount)
- Available with all valance options
- Not available with looped Roman, old style, angle top shades, continuous-loop lift, turned headrail, motorized lift, cordless lift, or multiple shades on one headrail

Options

Natural Drapes Control Options



Wand Control, no charge—Default Control Type

- Ivory fiberglass wand positioned behind drape
- Stack right, left, or split

Cord Control, no charge—Optional

- Cord and heavy duty tension pulley hidden behind drape
- Stack right, left, or split
- Split stack will have 2 wands

Wand Control Chart

Finished Blind Length inches (cm)	Cord Control Length inches (cm)	Wand Length inches (cm)
Up to 30 (76.2)	14 (35.6)	12 (30.5)
30 ¹ / ₁₆ to 48 (76.4 to 122.0)	26 (66.1)	24 (61.0)
48 ¹ / ₁₆ to 77 (122.1 to 195.6)	38 (96.6)	36 (91.5)
77 ¹ / ₁₆ to 92 (195.8 to 233.7)	50 (127.0)	48 (122.0)
92 ¹ / ₁₆ to 96 (233.9 to 243.9)	62 (157.5)	60 (152.4)

Fullness: Natural Drapes



Standard Fullness Right Stack

For surcharges, see options pricing

- Standard fullness (when closed, waves slightly)
- 60% fullness (when closed, features drapery-like appearance)
- Premiere valance included at time of order; see valance options for available styles



60% Fullness Right Stack

Options

Liners: Natural Shades and Natural Drapes

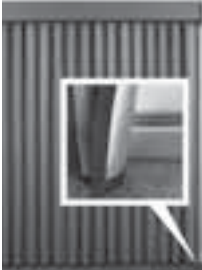

For surcharges, see options pricing

- Liners are 100% polyester
- Available up to 96" (243.9 cm) wide on shades and 192" (487.7 cm) on drapes
- Privacy and room-darkening liner colors available
- All liners are neutral to the street
- Liner reversal available upon request

Privacy Liner

A privacy liner is a good choice for dining rooms, living rooms, and other semi-private areas, subduing the light that enters a room. Objects appear as silhouettes from the outside.

Room-Darkening Liner

This liner blocks most incoming light and provides complete privacy. Ideal for bedrooms and media rooms.

Colors	Privacy Color Number	Room-Darkening Color Number
Cocoa	2297	6297
Taupe	2659	6659
Sand	2701	6701
Seal	2012	6012
Snow White	2909	6909

Edge Banding and Colors: Natural Shades and Natural Drapes



For surcharge, see options pricing

- Edge banding adds a framed color accent and can also eliminate material fray on edge of shade
- 1" (2.6 cm) or 2" (5.1 cm) fabric banding is applied to sides and bottom of shade and valance
- Deco-trim valance may be ordered with edge banded shades, valance will not have edge banding
- See chart for colors
- Edge banding not available on deco-trim or deco-pocket hems, angle top shades, cut-outs, or with hold down brackets

Woven Wood Drapes

- 1" (2.6 cm) or 2" (5.1 cm) solid colors available on top and bottom of drapes: **no charge**
- Optional 1" (2.6 cm) or 2" (5.1 cm) solid colors available on drape sides: **no charge**
- Lined drapes require edge banding on all four sides
- 1" (2.6 cm) edge banding of same color will be on top and bottom edge of valance
- Use chart below for colors

Edge Banding	1" (2.6 cm) Color Number	2" (5.1 cm) Color Number	Natural Shades	Natural Drapes
Black	7000	1000	•	•
Chocolate	7006	1005	•	•
Cocoa	7001	1001	•	•
Dark Beige	7005	1003	•	•
Gray	7176	1176	•	•
Light Sage	7173	1173	•	•
Mink Gray	7174	1174	•	•
Muslin	7172	1172	•	•
Serpentine Cocoa	N/A	3003	•	
Serpentine Cosmos	N/A	3170	•	
Serpentine Landscape	N/A	3171	•	
Smoke	7175	1175	•	•
Snow White	7170	1170	•	•
Taupe	7008	1007	•	•
Toffee	7002	1002	•	•
Trellis Basalt	N/A	3172	•	
Trellis Dune	N/A	3173	•	
Vanilla	7171	1171	•	•

Options

Cut-Outs: Natural Shades



For surcharge, see options pricing

- Available with standard and old style Roman shades
- Bottom corner cut-out (diagram A):
 - Maximum width: 6" (15.3 cm) cut-out
 - Any height (up to the headrail)
- Bottom center cut-out (diagram B):
 - Maximum height: 5" (12.7 cm) cut-out
 - Maximum width must leave 3" (7.7 cm) on each side of the cut-out
- Not available with: hold-down brackets, edge banding, deco-trim hems, deco-pocket hems, bottom up/top down shades, cordless lift, continuous-loop lift, or looped Roman shades

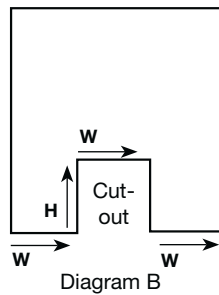
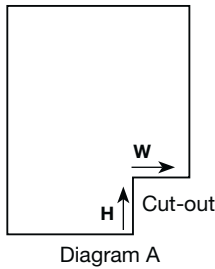

Angle Top: Natural Shades



For surcharges, see options pricing

- 3-day manufacturing time does not apply
- For angle top shades, supply all four measurements (A, B, C, D) as shown in the diagram below
- Shades will raise only to the bottom edge of the valance; the upper angled portion of the shades and valance cannot be opened and closed
- 6" (15.3 cm) and 9" (22.9 cm) standard valance only
- Valance requires gimp trim at the top edge by the headrail (A)
- Control location on low side only
- Not available with looped Roman shades, old style Roman shades, bottom up/top down, continuous-loop lift, cordless, motorized, turned headrail, or edge banding
- Valance returns are not available

Minimum Width	18" (45.8 cm) (outside mount) 18½" (47.0 cm) (inside mount)
Maximum Straight Width	60" (152.4 cm) (outside mount) 60½" (153.7 cm) (inside mount)
Minimum Height	12" (30.5 cm)
Minimum Height (short side)	7½" (19.1 cm)
Maximum Height	120" (304.8 cm)
Maximum Degree of Angle	60°

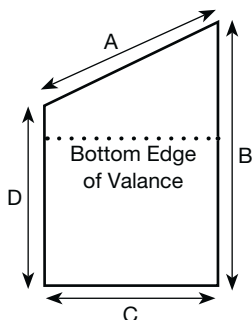

Measuring Outside Mount:

1. Measure exact width and height of area to be covered. It is recommended that shades overlap window frame or opening by 1½" (3.9 cm) on each side.
2. Measure height of opening on left side and mark this dimension "left". Allow for overlap as desired: 1½" (3.9 cm) on top and bottom is recommended.
3. Measure height of opening on the right side and mark this dimension "right". Allow for same overlap as left side.
4. Factory will determine the angle from these three dimensions.

Options

Multiple Shades on One Headrail: Natural Shades

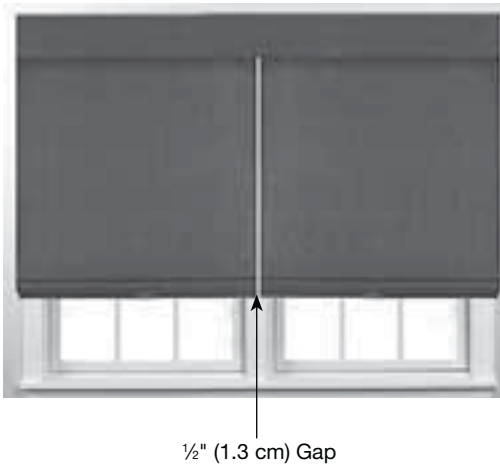

For surcharges, see options pricing

How to Measure

1. Measure overall width of area to be covered.
2. Measure width of the area each shade is to cover; measure and specify left shade first, continuing to the right.
NOTE: Minimum of 1/2" (1.3 cm) between shades for operating clearance.
3. Total width of all shades, plus clearance (gap), must equal the overall headrail width.
4. Use standard inside or outside measuring directions for height.
5. For patio doors, measure height to within 1" (2.6 cm) of the floor either from the ceiling or a point high enough above door to provide clearance; cords should be on outside edges of shades; outside mount (wall) installation is recommended for patio doors.

- Shades operate separately
- Controls can be on the right or left at no charge
 - Standard for two-on-one headrail: left panel—left control; right panel—right control
 - Standard for three-on-one headrail: left panel—left control; middle panel—right control; right panel—right control
- Cord Lift
 - Two-on-one available with control positions to the outside
 - Three-on-one not available on cord lift shades
- Cordless and motorized lift
 - Two-on-one and three-on-one available—no charge
- Continuous-loop cord lift
 - Two-on-one available with control positions to the outside
 - Three-on-one available if the lift control is combined on two shades (control positions must be to the outside)
 - Three-on-one available if the lift control is on combined on all three shades; horizontal material alignment between panels is not guaranteed
- Liner options available
- Edge banding is available—will be attached around each panel
- Shades up to the maximum material width will have a continuous valance
- Shades over maximum material width will have a valance with each panel which are butted in between each panel gap
- Premiere valance will not be spliced at the same dimensions as the multiple blinds; premiere valances will be spliced evenly

NOTE: Horizontal oriented valances over 96" (243.9 cm) will be spliced in one to three places and will not align with shade panels. Vertically oriented material will be one continuous piece. Hardwood frame will be spliced at 94" (238.8 cm) with returns and 95" (241.3 cm) without returns.

For Cordless Lift Shades Less than 18" (45.8 cm) in Width

If Finished Shade Width is inches (cm)	Maximum Height of Shade is inches (cm)
Equal to 12 (30.5) but less than 12½ (31.8)	15% (39.1)
Equal to 13 (33.1) but less than 13½ (34.3)	21% (55.0)
Equal to 13½ (34.3) but less than 14 (35.6)	28 (71.2)
Equal to 14 (35.6) but less than 14½ (36.9)	34¼ (87.0)
Equal to 14½ (36.9) but less than 15 (38.1)	40½ (102.9)
Equal to 15 (38.1) but less than 15½ (39.4)	46¾ (118.8)
Equal to 15½ (39.4) but less than 16 (40.7)	53% (135.0)
Equal to 16 (40.7) but less than 16½ (42.0)	59% (150.9)
Equal to 16½ (42.0) but less than 17 (43.2)	65% (166.7)
Equal to 17 (43.2) but less than 17½ (44.5)	72 (182.9)
Equal to 17½ (44.5) but less than 18 (45.8)	78¼ (198.8)
Equal to 18 (45.8) or more	See price charts

Options

Bay and Corner Windows

- Available on standard Roman and old style Roman shades
 - Bay and corner shades are used to butt two shades together in a corner window
 - Pull cords can be on the right or left side of each shade; locating cords opposite of the corner is recommended
 - Depending on the angle, some corner shades cannot be raised to the same height
 - Bay and corner shades not available with hold-down brackets, looped Roman shades, turned headrail, and multiple shades on one headrail
 - Horizontal pattern alignment between shades cannot be guaranteed
 - Priced as standard shades, no additional surcharge
 - Headrails will not be mitered
 - Standard valances will not be mitered
 - Premiere valances will be mitered
- NOTE:** Manufacturer will take appropriate deduction for corner/bay windows. If deductions are not required, do not order as corner/bay.

Measuring Information

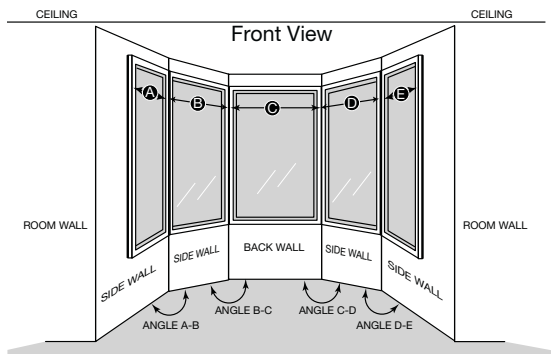
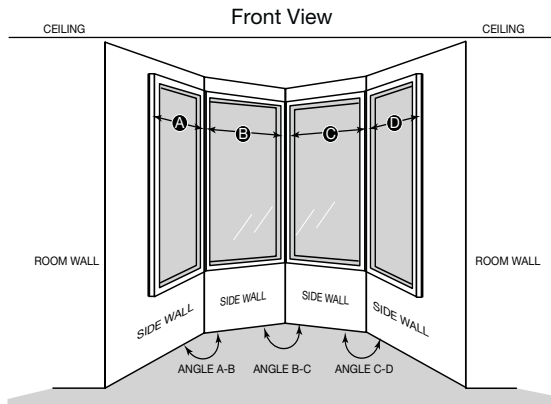
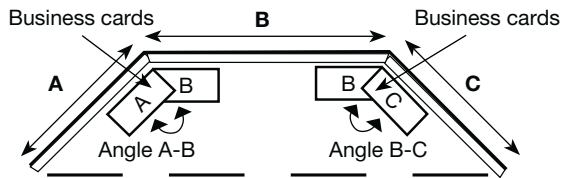
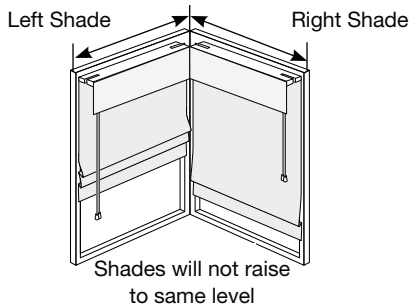

Corner Window

Measure:

Width of each window from corner to the point you would like to cover.

Three-Sided Bay Window

Measure:

A & C: Width of side windows from the corners to the point you would like the blind to cover.

B: Width of the center window from corner to corner.

Angle A-B: Angle between windows (A) and (B).

Angle B-C: Angle between windows (B) and (C).

Measure bay angle using protractor or angle finder, or use two business cards in bay corner as illustrated and fax to customer service.

Four-Sided Bay Window

Measure:

A & D: Width of side windows from the corners to the point you would like the blind to cover.

B & C: Width of each window from corner to corner.

Angle A-B: Angle between windows (A) and (B).

Angle B-C: Angle between windows (B) and (C).

Angle C-D: Angle between windows (C) and (D).

Measure bay angle using protractor or angle finder, or use two business cards in bay corner as illustrated and fax to customer service.

Five-Sided Bay Window

Measure:

A & E: Width of side windows from the corners to the point you would like the blind to cover.

B, C & D: Width of each center window from corner to corner.

Angle A-B: Angle between windows (A) and (B).

Angle B-C: Angle between windows (B) and (C).

Angle C-D: Angle between windows (C) and (D).

Angle D-E: Angle between windows (D) and (E).

Measure bay angle using protractor or angle finder, or use two business cards as illustrated and fax to customer service.

Options

Valance: Natural Shades

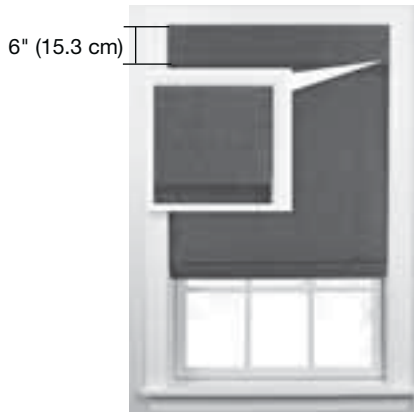

Standard Valance Horizontal Orientation



Premiere Valance Option B Shown

Cord lift no charge options

- 6" (15.3 cm) valance with shade
- No valance is optional; unfinished headrail and hardware are visible

Continuous-loop lift and motorized lift no charge options

- 9" (22.9 cm) valance with shade (6" (15.3 cm) valance is not available)

Cordless lift no charge options

- See valance: premiere valance only: natural shades and drapes section

Additional valance information

- Edge banding will be applied to the sides and bottom of the valance if option is chosen for complete finished shades
- Liner can be added to the valance; must specify privacy or room-darkening liner and color; see price chart for surcharge

Control Type/ Shade Options with Standard Valance	Full Recess Depth Including Valance inches (cm)	Standard Return Width Outside Mount inches (cm)	Standard Return Width Inside Mount inches (cm)	Minimum Return Width inches (cm)	Maximum Return Width inches (cm)
Cord Lift	2 ¹ / ₁₆ (6.2)	2 ¹ / ₁₆ (5.3)	1 ¹ / ₂ (3.9)	1 ¹ / ₂ (3.9)	3 ¹ / ₂ (8.9)
Continuous-Loop Lift	3 ³ / ₁₆ (8.1)	2 ¹³ / ₁₆ (7.2)	2 ¹ / ₄ (5.8)	1 ¹ / ₂ (3.9)	3 ¹ / ₂ (8.9)
Motorized Lift*	3 ³ / ₁₆ (8.1)	2 ¹³ / ₁₆ (7.2)	2 ¹ / ₄ (5.8)	1 ¹ / ₂ (3.9)	3 ¹ / ₂ (8.9)
Bottom Up/Top Down	2 ¹ / ₁₆ (6.2)	2 ¹ / ₁₆ (5.3)	1 ¹ / ₂ (3.9)	1 ¹ / ₂ (3.9)	3 ¹ / ₂ (8.9)

*See motorized product information guide for more details.

- Special 2" (5.1 cm) valance return **length**: available upon request
- No liner or edge banding on valance returns

Valance: Natural Drapes

- No charge for premiere valance at time of order (must select option)
- Liner is required for vertically oriented premiere valance
- No valance is optional; aluminum headrail and hardware are visible
- Valance return height will match valance height option chosen

Deco-Trim Valance or Hems: Natural Shades

Seascape



This design is scaled to the width of the shade

Dentil



This design will repeat with the width of the shade

Cathedral



This design will repeat with the width of the shade

Horizon



This design is scaled to the width of the shade

For surcharge, see options pricing

- Distinctive valance and hem designs with accent gimp
- Deco-trim valance or hem designs are cut into the valance or hem of the shade to a depth of approximately 2¹/₂" (6.4 cm)
- 9" (22.9 cm) deco-trim valance is measured from the top of the headrail to the lowest point
- Deco-trim hems allow light through at the bottom of the shade; if complete privacy and light filtering are desired, add 2¹/₂" (6.4 cm) to the ordered height
- Accent gimp must be selected with deco-trim valance or hem
- Available with 9" (22.9 cm) valance only

Options

Valance Returns for Standard Valances

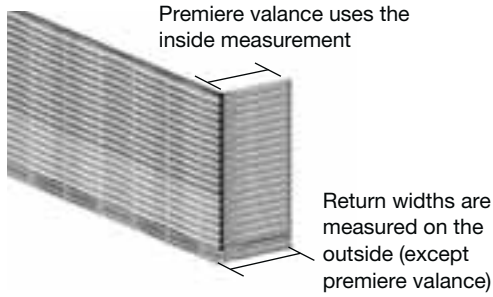

Window depths vary considerably depending on the age and style of the window. **Always** measure the window depth, regardless of the type of window treatment the client is considering. Knowing the depth when the order is placed can help prevent costly errors.

To calculate the return width, use this formula:

$$[\text{Standard return width}] \text{ minus } [\text{client window depth}] = \text{special return width to order for inside mount blind}$$

Valance: Premiere Valance Only: Natural Shades and Natural Drapes



Option A



Option B

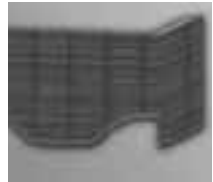

Option C

Premiere valance only

- No charge option for natural drape at time of order

Natural material is mounted to a North American hardwood frame with mitered corner returns that attach separately. Valance upgrade options provide stable returns and a clean, uniform appearance.

- Valance can be ordered for use alone or to complement other window treatments
- Valance material is attached to a hardwood frame; includes mounting brackets (standard, ceiling, or projection brackets)
- Valance returns are available (must be specified at the time of the order)
- Valance returns are standard on outside mount natural premiere valance based on headrail depth

Control Type/ Shade Options with Premiere Valance	Full Recess Depth Including Valance inches (cm)	Minimum Return Width inches (cm)	Return Width Inside/ Outside Mount— Standard Mounting Brackets inches (cm)	Return Width Inside/ Outside Mount— 2" (5.1 cm) Extension Brackets inches (cm)	Return Width Inside/ Outside Mount— 2 5/8" (6.7 cm) Extension Brackets inches (cm)	Return Width Inside/ Outside Mount— 3 1/2" (8.9 cm) Extension Brackets inches (cm)
Cord Lift	2 1/16 (6.2)	1 1/2 (3.9)	2 13/16 (7.2)	3 3/4 (9.6)	4 7/16 (11.3)	5 1/4 (13.4)
Continuous-Loop Lift	3 3/16 (8.1)	1 1/2 (3.9)	3 9/16 (9.1)	4 1/2 (11.5)	5 1/8 (13.1)	6 (15.3)
Motorized Lift*	3 3/16 (8.1)	1 1/2 (3.9)	3 9/16 (9.1)	4 1/2 (11.5)	5 1/8 (13.1)	6 (15.3)
Bottom Up/ Top Down	2 1/16 (6.2)	1 1/2 (3.9)	2 13/16 (7.2)	3 3/4 (9.6)	4 7/8 (12.4)	5 1/4 (13.4)
Cordless Lift	4 1/4 (10.8)	1 1/2 (3.9)	3 1/4 (8.3)	4 (10.2)	4 9/16 (11.6)	5 1/2 (14.0)
Drape	8 (20.4)	2 (5.1)	6 1/2 (16.6)	N/A	N/A	N/A

*See motorized product information guide for more details.

- Valances over maximum material width will be butted
- Edge banding is available on 6" (15.3 cm) or 9" (22.9 cm) horizontal or vertical oriented material; not available on deco-trim
- No liner or edge banding on valance returns

Options:

- 6" (15.3 cm) or 9" (22.9 cm) valance with horizontally material orientation; edge banding is optional (6" (15.3 cm) not available with motorized lift and continuous-loop lift).
- 6" (15.3 cm) or 9" (22.9 cm) valance with vertical material orientation; 1" (2.6 cm) edge banding top and bottom mandatory (6" (15.3 cm) not available with motorized lift and continuous-loop lift).
- 9" (22.9 cm) deco-trim valance; no vertical orientation option (must select accent gimp).
- Wood cornice: See cornices and valances price list.

NOTE: Horizontal oriented valances over 96" (243.9 cm) will be spliced in one to three places and will not align with shade panels. Vertically oriented material will be one continuous piece. Hardwood frame will be spliced at 94" (238.8 cm) with returns and 95" (241.3 cm) without returns.

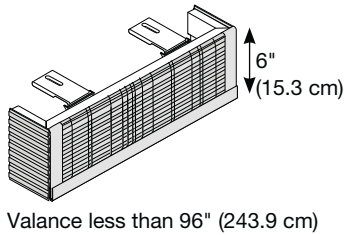

Valance less than 96" (243.9 cm)

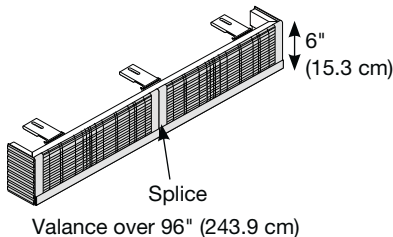

Valance over 96" (243.9 cm)

Options

Accent Gimp: Natural Shades



For surcharges, see price charts

- Required with 9" (22.9 cm) deco-trim valance or deco-pocket hem; optional on other horizontal material orientation valances and standard hems
- Not available with vertically-oriented material



NOTE: Must choose accent gimp color when a deco-trim style has been selected for the valance or hem.

Black	156	Rock Gray	399
Chocolate	04	Tender Taupe	103
Cream	715	Toffee	296
Dark Beige	350	White	417

Deco-Pocket Hem: Natural Shades

Dentil—Hem with Accent Rod



Cathedral—Hem with Accent Rod



For surcharges, see options pricing

- 3-day manufacturing time does not apply
- Distinctive hem designs with decorative accent rod and accent gimp
- 5/8" (1.6 cm) diameter metal rods with a classic ball finial, cut to width
 - Accent rod: maximum width 72" (182.9 cm)
- Deco-pocket hems also available without accent rod to add your own decorative hardware
- Deco-pocket hem designs are cut into the hem of the shades to a depth of approximately 4 1/2" (11.5 cm), allowing light through the bottom of the shades
 - If complete privacy and light filtering are desired, add 4 1/2" (11.5 cm) to the ordered height
- Must select accent gimp with deco valance or hem
- Not available with cut-out, cordless lift, or motorized lift

Rod Colors Available:

Matte Black	84
Satin Nickel	59

Options

Turned Headrail: Natural Shades

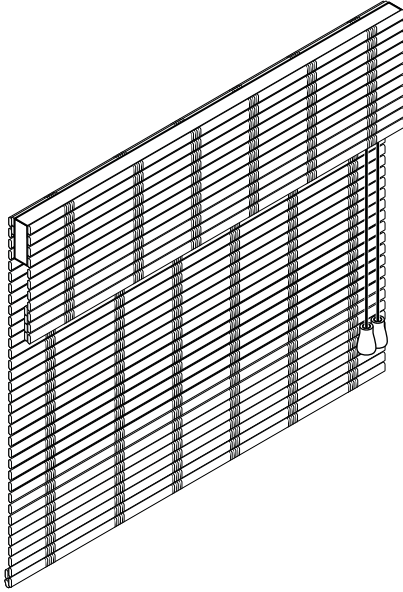

- **No charge**
- Headrail turned 90 degrees to allow for a smaller inside mount shade or for use on French doors
- Available as inside or outside mount; headrail mounted by placing mounting screws through headrail directly into mounting surface
- Minimum depth required: ¾" (2.0 cm)
- Available with cord lift and old style Roman
- 6" (15.3 cm) standard or 9" (22.9 cm) deco-trim valance available options; see price charts for surcharge
- Not available with bay or corner windows, bottom up/top down
- **Valance returns are not available**

General Information

Stack Charts: Natural Shades

NOTE: For shades, stack height is measured from the top of the headrail to the lowest point of the shades when completely raised. Stack heights are approximate and will vary by material.

Stack Height: Natural Shades

	Height of Shade up to inches (cm)	Standard Hem		Deco-Trim Hem Deco-Pocket Hem	
		No Liner inches (cm)	Privacy or Room-Darkening Liner inches (cm)	No Liner inches (cm)	Privacy or Room-Darkening Liner inches (cm)
Cord Lift • Standard Roman • Old Style Roman • Turned Headrail Roman	30 (76.2)	8¾-9¾ (22.3-24.8)	8¾-10 (22.3-25.4)	13¾-14¾ (35.0-37.5)	13¾-14¾ (35.0-37.5)
	50 (127.0)	10¼-10½ (26.1-26.7)	10¼-10½ (26.1-26.7)	15-15¼ (38.1-38.8)	15-15¼ (38.1-38.8)
	70 (177.8)	10¾-11 (27.4-28.0)	10¾-11¼ (27.4-28.6)	15½-15¾ (39.4-40.1)	15½-15¾ (39.4-40.1)
	90 (228.6)	11¼-11½ (28.6-29.3)	11½-11¾ (29.3-29.9)	16-16¼ (40.7-41.3)	16-16¼ (40.7-41.3)
	110 (279.4)	11¾-12 (29.9-30.5)	12-12¼ (30.5-31.2)	16½-16¾ (42.0-42.6)	16½-16¾ (42.0-42.6)
	120 (304.8)	12-12½ (30.5-31.8)	12¼-12½ (31.2-31.8)	17-17¼ (43.2-43.9)	17-17¼ (43.2-43.9)
Continuous-Loop Lift Motorized Lift • Standard Roman • Old Style Roman	30 (76.2)	9¾-10 (24.8-25.4)	9¾-10¼ (24.8-26.1)	14½-15 (36.9-38.1)	14½-15 (36.9-38.1)
	50 (127.0)	10¼-10¾ (26.1-27.4)	10½-11 (26.7-28.0)	15¼-15¾ (38.8-40.1)	15¼-15¾ (38.8-40.1)
	70 (177.8)	11-11¼ (28.0-28.6)	11¼-11½ (28.6-29.3)	16-16¼ (40.7-41.3)	16-16¼ (40.7-41.3)
	90 (228.6)	11½-11¾ (29.3-29.9)	11¾-12 (29.9-30.5)	16½-16¾ (42.0-42.6)	16½-16¾ (41.3-42.6)
	110 (279.4)	12-12¼ (30.5-31.2)	12¼-12½ (31.2-31.8)	17-17¼ (43.2-43.9)	17-17¼ (43.2-43.9)
	120 (304.8)	12½-12¾ (31.8-32.4)	12¾-13 (32.4-33.1)	17½-17¾ (44.5-45.1)	17½-17¾ (44.5-45.1)
Cord Lift • Looped Roman	30 (76.2)	9¾-10½ (24.8-26.7)	9¾-10¾ (24.8-27.4)	14½-15 (36.9-38.1)	14½-15¼ (36.9-38.8)
	50 (127.0)	10¾-11¼ (27.4-29.9)	11-12 (28.0-30.5)	15¼-16¼ (38.8-41.3)	15¾-16¼ (40.1-42.6)
	70 (177.8)	12-13 (30.5-33.1)	12¼-13 (31.2-33.1)	16½-17¼ (42.0-43.9)	17-17¾ (43.2-45.1)
	90 (228.6)	13¼-14 (33.7-35.6)	13¼-14¼ (33.7-36.2)	17½-18½ (44.5-47.0)	18-19 (45.8-48.3)
	110 (279.4)	14¼-14¾ (36.2-36.9)	14½-15 (36.9-38.1)	18¾-19¼ (47.7-48.9)	19¼-20 (48.9-50.8)
	120 (304.8)	14¾-15 (37.5-38.1)	15¼-15¾ (38.8-40.1)	19½-19¾ (49.6-50.2)	20-20¼ (50.8-51.5)
Continuous-Loop Lift • Looped Roman	30 (76.2)	10¾-11 (27.4-28.0)	10¾-11¼ (27.4-28.6)	15½-16¼ (39.4-41.3)	15½-16¼ (39.4-41.3)
	50 (127.0)	11¼-12¼ (28.6-31.2)	11½-13¼ (29.3-33.7)	16½-17 (42.0-43.2)	16½-17½ (42.0-44.5)
	70 (177.8)	12½-13¾ (31.8-35.0)	13½-14¼ (34.3-36.2)	17¼-18 (43.9-45.8)	17¾-18¼ (45.1-47.7)
	90 (228.6)	14-14½ (35.6-36.9)	14½-15¼ (36.9-38.8)	18¼-19 (46.4-48.3)	19-20 (48.3-50.8)
	110 (279.4)	14¾-15¼ (37.5-38.8)	15½-16¼ (39.4-41.3)	19¼-20 (48.9-50.8)	20¼-21 (51.5-53.4)
	120 (304.8)	15½-15¾ (39.4-40.1)	16½-16¾ (42.0-42.6)	20¼-20½ (51.5-52.1)	21¼-21½ (54.0-54.7)
Cord Lift • Bottom Up/Top Down Roman	30 (76.2)	10¾-11 (27.4-28.0)	10¾-11 (27.4-28.0)	15½-15¾ (39.4-40.1)	15½-15¾ (39.4-40.1)
	50 (127.0)	11¼-11½ (28.6-29.3)	11¼-11½ (28.6-29.3)	16-16¼ (40.7-41.3)	16-16¼ (40.7-41.3)
	70 (177.8)	11¾-12 (29.9-30.5)	11¾-12 (29.9-30.5)	16½-16¾ (42.0-42.6)	16½-16¾ (42.0-42.6)
	90 (228.6)	12¼-12½ (31.2-31.8)	12¼-12½ (31.2-31.8)	17-17¼ (43.2-43.9)	17-17¼ (43.2-43.9)
	110 (279.4)	12¾-13 (32.4-33.1)	12¾-13 (32.4-33.1)	17½-17¾ (44.5-45.1)	17½-17¾ (44.5-45.1)
	120 (304.8)	13¼-13½ (33.7-34.3)	13¼-13½ (33.7-34.3)	17¾-18 (45.1-45.8)	17¾-18 (45.1-45.8)
Cordless Lift • Standard Roman	30 (76.2)	8¾-9¾ (22.3-24.8)	8¾-10 (22.3-25.4)	N/A	N/A
	50 (127.0)	10¼-10½ (26.1-26.7)	10¼-10½ (26.1-26.7)		
	70 (177.8)	10¾-11 (27.4-28.0)	10¾-11¼ (27.4-28.6)		
	90 (228.6)	11¼-11½ (28.6-29.3)	11½-11¾ (29.3-29.9)		
	110 (279.4)	11¾-12 (29.9-30.5)	12-12¼ (30.5-31.2)		
	120 (304.8)	12-12½ (30.5-31.8)	12¼-12½ (31.2-31.8)		

General Information

Stack Charts: Natural Drapes

NOTE: For drapes, stack width is measured from the outside of the drapes to the inside of the drapes. Stack widths are approximate and will vary by material.

Natural Drapes 10% Standard Fullness Stack Chart

Width of Shade up to inches (cm)	Cord Control				Wand Control			
	Single Stack		Split Stack, Each Side		Single Stack		Split Stack, Each Side	
	Minimum Range Thinner Fabrics inches (cm)	Minimum Range Thicker Fabrics inches (cm)	Minimum Range Thinner Fabrics inches (cm)	Minimum Range Thicker Fabrics inches (cm)	Minimum Range Thinner Fabrics inches (cm)	Minimum Range Thicker Fabrics inches (cm)	Minimum Range Thinner Fabrics inches (cm)	Minimum Range Thicker Fabrics inches (cm)
27 (68.6)	5-7 (12.7-17.8)	7-9 (17.8-22.9)	3-4 (7.7-10.2)	5-6 (12.7-15.3)	6½-9 (16.6-22.9)	9-12 (22.9-30.5)	5½-7½ (14.0-19.1)	7½-9½ (19.1-24.2)
40 (101.6)	7-9 (17.8-22.9)	9-13 (22.9-33.1)	4-5 (10.2-12.7)	6-7 (15.3-17.8)	9-11 (22.9-28.0)	12-15 (30.5-38.1)	7½-9 (19.1-22.9)	9½-11½ (24.2-29.3)
51 (129.6)	9-11 (22.9-28.0)	13-16 (33.1-40.7)	5-6 (12.7-15.3)	7-8 (17.8-20.4)	11-14 (28.0-35.6)	15-18 (38.1-45.8)	9-10½ (22.9-26.7)	11½-13½ (29.3-34.3)
63 (160.1)	11-13 (28.0-33.1)	16-19 (40.7-48.3)	6-7 (15.3-17.8)	8-9 (20.4-22.9)	14-16 (35.6-40.7)	18-21 (45.8-53.4)	10½-12 (26.7-30.5)	13½-15 (34.3-38.1)
75 (190.5)	13-15 (33.1-38.1)	19-22 (48.3-55.9)	7-8 (17.8-20.4)	9-10 (22.9-25.4)	16-18 (40.7-45.8)	21-24 (53.4-61.0)	12-13½ (30.5-34.3)	15-16½ (38.1-42.0)
88 (223.6)	15-17 (38.1-43.2)	22-25 (55.9-63.5)	8-9 (20.4-22.9)	10-12 (25.4-30.5)	18-20 (45.8-50.8)	24-27 (61.0-68.6)	13½-14½ (34.3-36.9)	16½-18 (42.0-45.8)
102 (259.1)	17-19 (43.2-48.3)	25-28 (63.5-71.2)	9-10 (22.9-25.4)	12-14 (30.5-35.6)	20-22 (50.8-55.9)	27-30 (68.6-76.2)	14½-15 (36.9-38.1)	18-19½ (45.8-49.6)
115 (292.1)	19-21 (48.3-53.4)	28-31 (71.2-78.8)	10-11 (25.4-28.0)	14-16 (35.6-40.7)	22-24 (55.9-61.0)	30-33 (76.2-83.9)	15½-16½ (39.4-42.0)	19½-21 (49.6-53.4)
128 (325.2)	21-23 (53.4-58.5)	31-34 (78.8-86.4)	11-12 (28.0-30.5)	16-18 (40.7-45.8)	24-26 (61.0-66.1)	33-36 (83.9-91.5)	16½-18 (42.0-45.8)	21-22½ (53.4-57.2)
141 (358.2)	23-25 (58.5-63.5)	34-37 (86.4-94.0)	12-13 (30.5-33.1)	18-20 (45.8-50.8)	26-28 (66.1-71.2)	36-39 (91.5-99.1)	18-19 (45.8-48.3)	22½-24 (57.2-61.0)
157 (398.8)	25-27 (63.5-68.6)	37-40 (94.0-101.6)	13-14 (33.1-35.6)	20-22 (50.8-55.9)	28-30 (71.2-76.2)	39-43 (99.1-109.3)	19-21 (48.3-53.4)	24-25 (61.0-63.5)
170 (431.8)	27-29 (68.6-73.7)	40-43 (101.6-109.3)	14-15 (35.6-38.1)	22-24 (55.9-61.0)	30-32 (76.2-81.3)	43-46 (109.3-116.9)	21-22 (53.4-55.9)	25-26 (63.5-66.1)
183 (464.9)	29-31 (73.7-78.8)	43-46 (109.3-116.9)	15-16 (38.1-40.7)	24-26 (61.0-66.1)	32-35 (81.3-88.9)	46-49 (116.9-124.5)	22-23 (55.9-58.5)	26-27 (66.1-68.6)
192 (487.7)	31-33 (78.8-83.9)	46-49 (116.9-124.5)	16-17 (40.7-43.2)	26-28 (66.01-71.2)	35-37 (88.9-94.0)	49-53 (124.5-134.7)	23-24 (58.5-61.0)	27-28 (68.6-71.2)

Natural Drapes 60% Fullness Stack Chart

Width of Shade up to inches (cm)	Cord Control				Wand Control			
	Single Stack		Split Stack, Each Side		Single Stack		Split Stack, Each Side	
	Minimum Range Thinner Fabrics inches (cm)	Minimum Range Thicker Fabrics inches (cm)	Minimum Range Thinner Fabrics inches (cm)	Minimum Range Thicker Fabrics inches (cm)	Minimum Range Thinner Fabrics inches (cm)	Minimum Range Thicker Fabrics inches (cm)	Minimum Range Thinner Fabrics inches (cm)	Minimum Range Thicker Fabrics inches (cm)
27 (68.6)	6-8½ (15.3-21.6)	8½-14 (21.6-35.6)	3½-6 (8.9-15.3)	6-9 (15.3-22.9)	8-12 (20.4-30.5)	11-16 (28.0-40.7)	7-9 (17.8-22.9)	9-12 (22.9-30.5)
40 (101.6)	8½-13 (21.6-33.1)	14-18 (35.6-45.8)	6-8 (15.3-20.4)	9-12 (22.9-30.5)	12-15 (30.5-38.1)	16-21 (40.7-53.4)	9-11 (22.9-28.0)	12-14 (30.5-35.6)
51 (129.6)	13-15½ (33.1-39.4)	18-22 (45.8-55.9)	8-10 (20.4-25.4)	12-14 (30.5-35.6)	15-18 (38.1-45.8)	21-25 (53.4-63.5)	11-13 (28.0-33.1)	14-16 (35.6-40.7)
63 (160.1)	15½-18 (39.4-45.8)	22-27 (55.9-68.6)	10-12 (25.4-30.5)	14-17 (35.6-43.2)	18-21 (45.8-53.4)	25-30 (63.5-76.2)	13-15 (33.1-38.1)	16-18 (40.7-45.8)
75 (190.5)	18-22 (45.8-55.9)	27-31 (68.6-78.8)	12-14 (30.5-35.6)	17-19 (43.2-48.3)	21-24 (53.4-61.0)	30-35 (76.2-88.9)	15-17 (38.1-43.2)	18-20 (45.8-50.8)
88 (223.6)	22-25 (55.9-63.5)	31-37 (78.8-94.0)	14-16 (35.6-40.7)	19-22 (48.3-55.9)	24-27 (61.0-68.6)	35-40 (88.9-101.6)	17-19 (43.2-48.3)	20-22 (50.8-55.9)
102 (259.1)	25-29 (63.5-73.7)	37-41 (94.0-104.2)	16-18 (40.7-45.8)	22-25 (55.9-63.5)	27-30 (68.6-76.2)	40-44 (101.6-111.8)	19-21 (48.3-53.4)	22-25 (55.9-63.5)
115 (292.1)	29-32 (73.7-81.3)	41-46 (104.2-116.9)	18-20 (45.8-50.8)	25-28 (63.5-71.2)	30-34 (76.2-86.4)	44-49 (111.8-124.5)	21-23 (53.4-58.5)	25-28 (63.5-71.2)
128 (325.2)	32-35 (81.3-88.9)	46-51 (116.9-129.6)	20-22 (50.8-55.9)	28-31 (71.2-78.8)	34-38 (86.4-96.6)	49-54 (124.5-137.2)	23-25 (58.5-63.5)	28-30 (71.2-76.2)
141 (358.2)	35-38 (88.9-96.6)	51-56 (129.6-142.3)	22-24 (55.9-61.0)	31-33 (78.8-83.9)	38-42 (96.6-106.7)	54-60 (137.2-152.4)	25-27 (63.5-68.6)	30-32 (76.2-81.3)
157 (398.8)	38-42 (96.6-106.7)	56-62 (142.3-157.5)	24-26 (61.0-66.1)	33-35 (83.9-88.9)	42-46 (106.7-116.9)	60-66 (152.4-167.7)	27-29 (68.6-73.7)	32-36 (81.3-91.5)
170 (431.8)	42-46 (106.7-116.9)	62-67 (157.5-170.2)	26-28 (66.1-71.2)	35-38 (88.9-96.6)	46-49 (116.9-124.5)	66-71 (167.7-180.4)	29-31 (73.7-78.8)	36-38 (91.5-96.6)
183 (464.9)	46-49 (116.9-124.5)	67-72 (170.2-182.9)	28-30 (71.2-76.2)	38-40 (96.6-101.6)	49-52 (124.5-132.1)	71-75 (180.4-190.5)	31-33 (78.8-83.9)	38-40 (96.6-101.6)
192 (487.7)	49-51 (124.5-129.6)	72-76 (182.9-193.1)	30-32 (76.2-81.3)	40-42 (101.6-106.7)	52-55 (132.1-139.7)	75-80 (190.5-203.2)	33-36 (83.9-91.5)	40-43 (101.6-109.3)

General Information

Natural Shades Product Detail

Standard Roman

Valance

- 6" (15.3 cm) valance is standard on standard and looped Roman
- No valance on old style Roman

Hold Down Brackets (optional)

- Secure bottomrail to door, wall, or window sill; must be specified at time of order

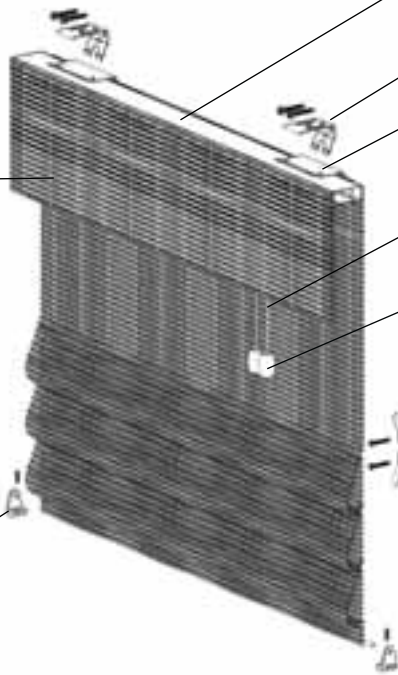

Hardwood Headrail

- Made from sustainable hardwood resources

Standard Installation Brackets

- Steel

Mounting Plate

- Aluminum

Lift Cord

- Color coordinated 1.8 mm cord with filler for durability

Wood Tassel

- Color coordinated to the shade

Safety Cord Cleat

- Prevents cord from twisting and enhances safety in homes with children and pets
- Standard clear cord cleat (included)
- Decorative cord cleat (solid brass or antique brass)



2" (5.1 cm)
Short Return

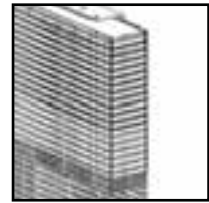

Standard 6" (15.3 cm)
Return

Standard Roman Turned Headrail



(Direct mount shade; no returns available)

Old Style Roman

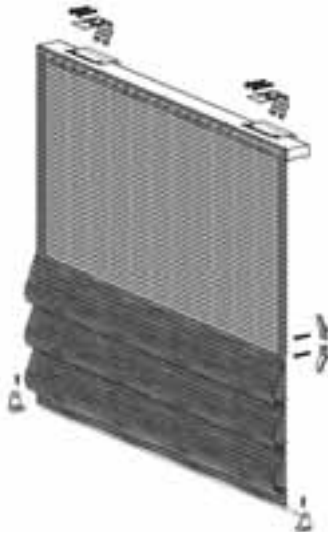

Cord lift (lift cords are behind the shade; outside mount shown).
4" (10.2 cm) seclusion strip is used on inside mount.

Bottom Up/Top Down

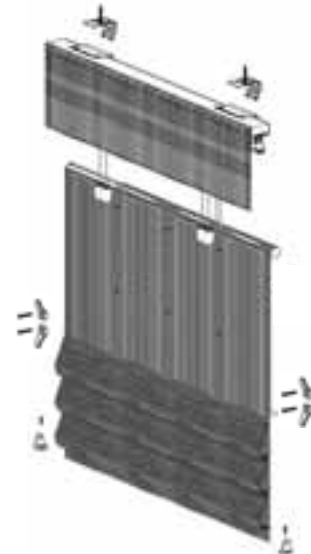

4" (10.2 cm) seclusion strip is used on inside mount.

Cord Winder



Decorative Cord Cleats



Solid Brass

Antique Brass

General Information

Natural Shades Looped Roman Product Detail

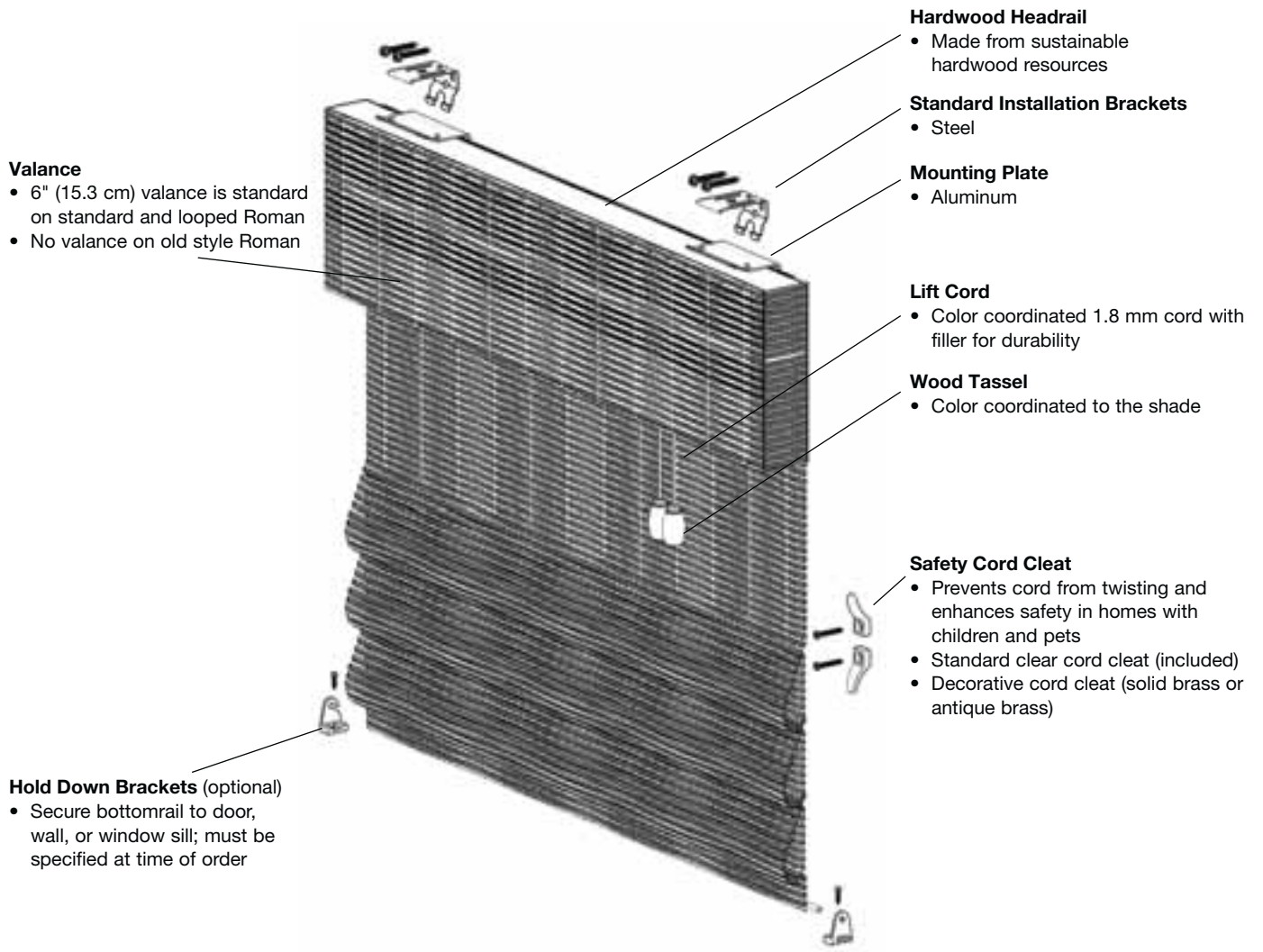

<p>Cord Winder</p> 	<p>Decorative Cord Cleats</p>  <p>Solid Brass Antique Brass</p>
---	--

General Information

Natural Shades Cordless Lift Product Detail

Durable Headrail with Natural Material Valance

- Classic 1½" (3.9 cm) high x 2⅝" (5.4 cm) deep

Mounting Brackets

- Designed for easy and trouble-free installation

Premiere Valance Clips

Clear Hand Grips

- Guide to raise and lower blinds

Hold Down Brackets (optional)

- Secures blind to door, wall, or window sill

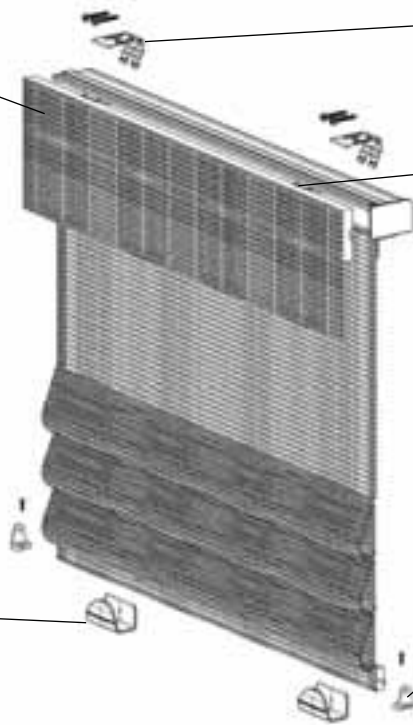

Natural Shades Continuous-Loop Lift Product Detail

Valance

- 9" (22.9 cm) valance is standard on standard Roman and looped Roman

Hardwood Headrail

- Made from shade height
- If more than 30 square feet (2.8 square meters), metal bead chain is required; optional for shades under that size

Mounting Brackets

- Designed for easy and trouble-free installation

Mounting Plate

- Aluminum

Safety Cord Guide

- Prevents cord from twisting and enhances safety in homes with children and pets

Hold Down Brackets (optional)

- Secure bottomrail to door, wall, or window sill; must be specified at time of order

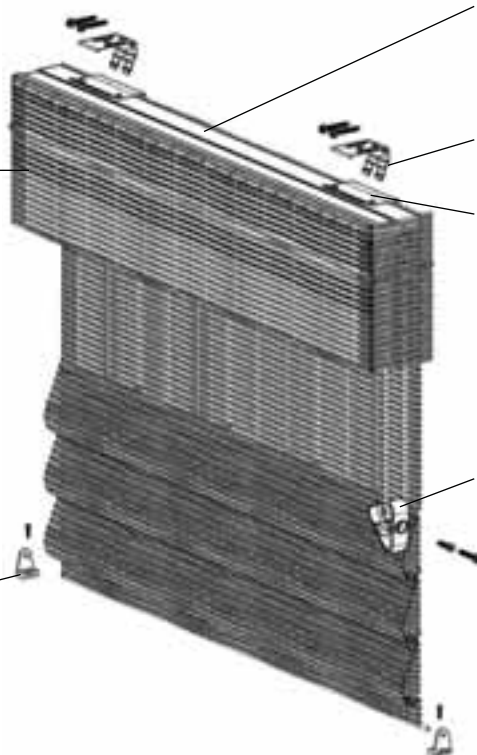

Safety Cord Guide



Safety Chain Guide

General Information

Natural Drapes Product Detail

Wand Control

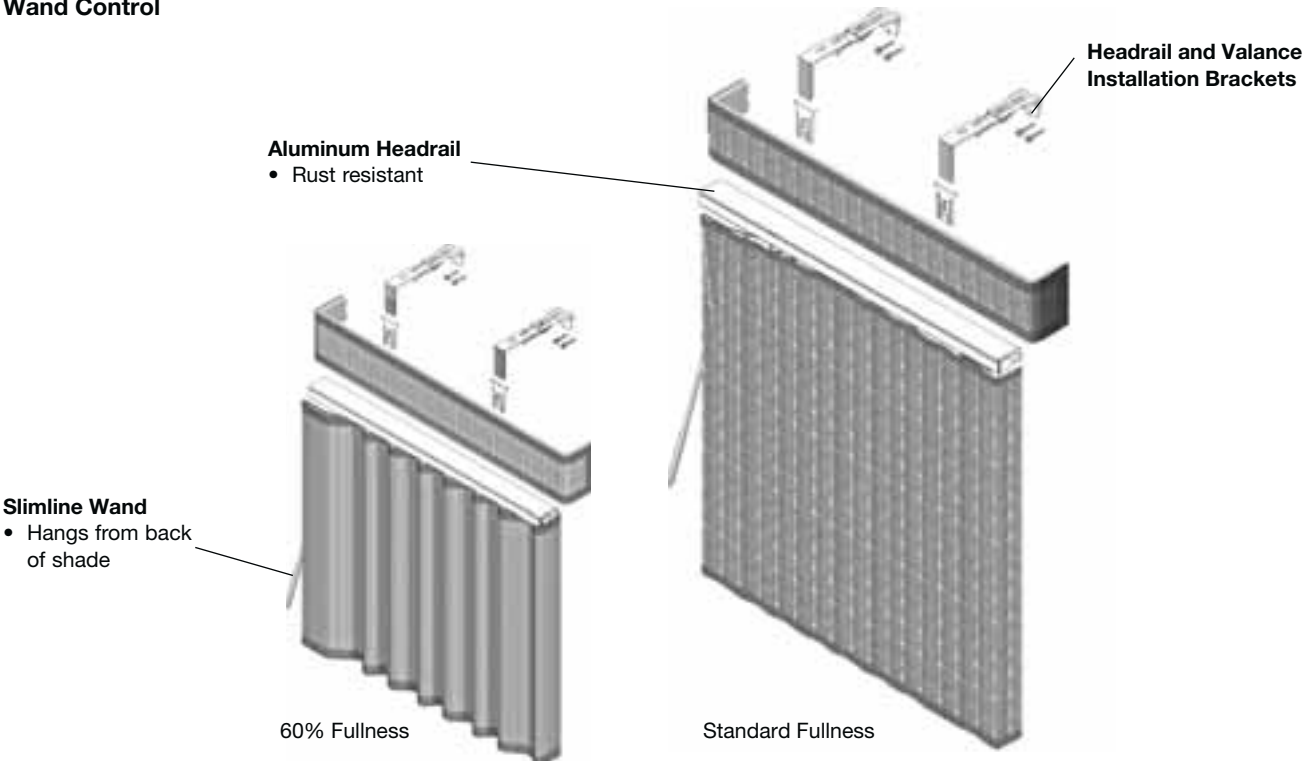

NOTE: Natural materials are vertically oriented on the natural drapes and valance.

Cord Control

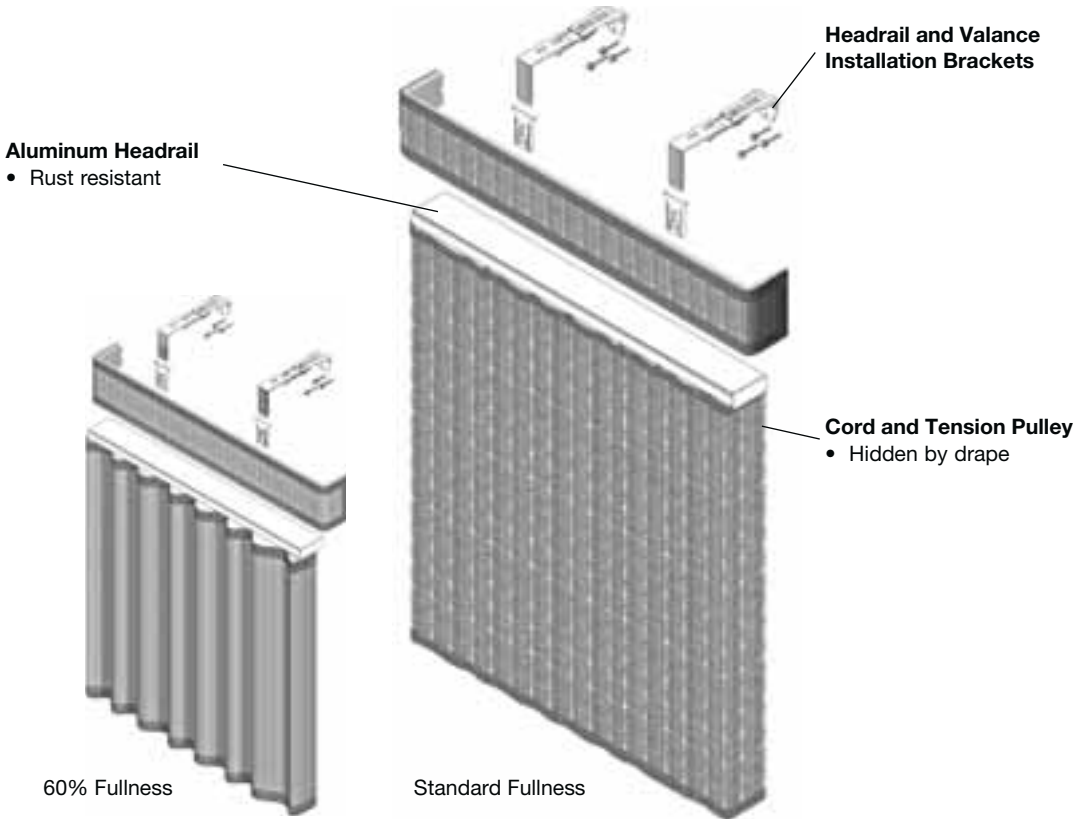

Price Charts

Price Group A: Lipo, Revelry

Standard Roman and Old Style Roman

Height up to inches (cm) ↓	Width up to inches (cm) →												
	22 (55.9)	26 (66.1)	30 (76.2)	36 (91.5)	42 (106.7)	48 (122.0)	60 (152.4)	72 (182.9)	84 (213.4)	96 (243.9)	108 (274.4)	120 (304.8)	144 (365.8)
34 (86.4)	\$180	195	215	247	260	276	337	392	477	563	600	637	717
42 (106.7)	194	218	237	268	288	308	375	435	528	621	664	710	794
48 (122.0)	208	229	254	288	309	333	404	471	570	666	717	768	869
54 (137.2)	220	245	268	308	333	360	432	509	615	715	773	829	944
60 (152.4)	237	258	287	329	354	382	462	545	653	761	823	885	1005
66 (167.7)	247	274	303	348	378	409	495	583	698	811	877	944	1080
72 (182.9)	260	289	321	366	400	432	526	621	735	854	930	1000	1148
84 (213.4)	288	319	351	407	443	485	585	690	821	956	1038	1122	1288
96 (243.9)	314	348	388	448	491	534	651	761	903	1049	1142	1237	1427
108 (274.4)	345	381	427	473	534	593	701	839	982	1148	1247	1352	1558
120 (304.8)	373	415	464	515	577	654	764	917	1063	1245	1355	1470	1691

Add Surcharge to Shade Price

	\$119						119			119			
Cordless Lift													
Privacy Liner	69	84	101	113	124	141	167	209	238	261	293	329	392
Room-Darkening Liner	96	110	133	152	164	186	219	279	314	348	391	435	521
Valance Liner	17	20	26	28	32	35	41	50	55	59	69	77	92
Premiere Valance	40	43	48	50	55	61	77	84	93	107	119	137	159
Deco-Trim Valance or Deco-Trim Hem	82	84	89	91	93	97	101	105	113	118	124	127	135
Deco-Trim Pocket Hem, with Accent Rod	188	196	205	210	215	232	240	249	290	300	329	336	354
Deco-Trim Pocket Hem No Accent Rod	159	165	169	173	180	184	191	203	217	226	237	243	260

Dotted line cordless lift, Lipo. Solid line cordless lift, Revelry. Multiple cordless lift shades available up to 144" (365.8 cm). Liners available on all specialties except deco-trim valances. Cordless lift shades with liners have smaller size limits. Please contact customer service for the most up to date size considerations.

Due to material width sizes, shades to the right of the solid line must be manufactured as multiple shades on one headrail.

Looped Roman

Height up to inches (cm) ↓	Width up to inches (cm) →												
	22 (55.9)	26 (66.1)	30 (76.2)	36 (91.5)	42 (106.7)	48 (122.0)	60 (152.4)	72 (182.9)	84 (213.4)	96 (243.9)	108 (274.4)	120 (304.8)	144 (365.8)
34 (86.4)	\$235	254	279	322	338	360	438	510	621	731	782	828	933
42 (106.7)	253	283	308	349	375	400	486	566	687	807	863	921	1032
48 (122.0)	272	297	330	375	403	433	525	612	742	865	933	997	1131
54 (137.2)	287	319	349	400	433	467	561	661	799	930	1005	1078	1227
60 (152.4)	308	335	374	428	461	497	600	710	849	990	1070	1149	1308
66 (167.7)	322	356	394	451	491	531	643	758	906	1054	1140	1227	1404
72 (182.9)	338	376	418	476	521	561	684	807	957	1110	1209	1299	1491
84 (213.4)	375	414	456	529	577	631	761	899	1067	1242	1350	1459	1676
96 (243.9)	408	451	504	582	638	693	846	990	1173	1364	1485	1607	1854
108 (274.4)	448	496	555	616	693	770	910	1091	1278	1491	1621	1758	2026
120 (304.8)	484	540	603	671	748	850	994	1192	1381	1619	1763	1911	2199

Add Surcharge to Shade Price

Privacy Liner	\$83	94	110	122	132	150	176	217	244	267	303	337	400
Room-Darkening Liner	109	124	145	162	176	200	232	290	328	361	400	447	535
Valance Liner	17	20	26	28	32	35	41	50	55	59	69	77	92
Premiere Valance	40	43	48	50	55	61	77	84	93	107	119	137	159
Deco-Trim Valance or Deco-Trim Hem	82	84	89	91	93	97	101	105	113	118	124	127	135
Deco-Trim Pocket Hem, with Accent Rod	188	196	205	210	215	232	240	249	290	300	329	336	354
Deco-Trim Pocket Hem No Accent Rod	159	165	169	173	180	184	191	203	217	226	237	243	260

Due to material width sizes, shades to the right of the solid line must be manufactured as multiple shades on one headrail. Liners are 100% polyester. Liners available on all specialties except deco-trim valances. Due to weight limitations, shades with deco-pocket hems in the shaded area must be manufactured as multiple shades on one headrail at no charge.

Colors

Lipo

Ambrosia 06702
 Earthtones 06793
 Java 06703
 Tahoe 60705

Revelry

Birdnest 80045
 Dove 80745
 Dusk 80743

Price Charts

Price Group B: Chencun, Escape, Majian, Serenity, Toushan II

Standard Roman and Old Style Roman

Height up to inches (cm) ↓	Width up to inches (cm) →												
	22 (55.9)	26 (66.1)	30 (76.2)	36 (91.5)	42 (106.7)	48 (122.0)	60 (152.4)	72 (182.9)	84 (213.4)	96 (243.9)	108 (274.4)	120 (304.8)	144 (365.8)
34 (86.4)	\$205	235	243	276	288	315	391	447	540	629	665	712	859
42 (106.7)	221	246	261	303	330	364	419	490	588	701	755	805	959
48 (122.0)	243	268	293	334	368	402	462	521	632	756	832	888	1055
54 (137.2)	249	276	312	352	390	427	495	561	693	804	860	948	1121
60 (152.4)	266	294	330	376	419	462	531	606	730	854	913	1003	1186
66 (167.7)	278	312	348	402	438	484	570	651	789	904	968	1065	1257
72 (182.9)	294	324	368	423	467	521	606	696	814	951	1025	1128	1325
84 (213.4)	322	352	403	467	525	577	680	784	907	1063	1165	1244	1453
96 (243.9)	352	389	437	512	571	635	753	866	1001	1165	1278	1371	1608
108 (274.4)	379	443	471	543	616	687	816	945	1247	1271	1386	1500	1773
120 (304.8)	409	480	507	578	660	747	881	1018	1259	1377	1497	1619	1935

Add Surcharge to Shade Price

	\$119						119			119			
Cordless Lift	69	84	101	113	124	141	167	209	238	261	293	329	392
Privacy Liner	96	110	133	152	164	186	219	279	314	348	391	435	521
Room-Darkening Liner	17	20	26	28	32	35	41	50	55	59	69	77	92
Valance Liner	40	43	48	50	55	61	77	84	93	107	119	137	159
Premiere Valance	82	84	89	91	93	97	101	105	113	118	124	127	135
Deco-Trim Valance or Deco-Trim Hem	188	196	205	210	215	232	240	249	290	300	329	336	354
Deco-Trim Pocket Hem, with Accent Rod	159	165	169	173	180	184	191	203	217	226	237	243	260
Deco-Trim Pocket Hem No Accent Rod													

Dotted line cordless lift, Serenity and Toushan II. Solid line cordless lift, Chencun, Escape, and Majian. Multiple cordless lift shades available up to 144" (365.8 cm). Liners available on all specialties except deco-trim valances. Cordless shades with liners have smaller size limits. Please contact customer service for the most up to date size considerations.

Due to material width sizes, shades to the right of the solid line must be manufactured as multiple shades on one headrail.

Looped Roman

Height up to inches (cm) ↓	Width up to inches (cm) →												
	22 (55.9)	26 (66.1)	30 (76.2)	36 (91.5)	42 (106.7)	48 (122.0)	60 (152.4)	72 (182.9)	84 (213.4)	96 (243.9)	108 (274.4)	120 (304.8)	144 (365.8)
34 (86.4)	\$267	307	315	360	375	409	509	581	702	818	864	924	1117
42 (106.7)	288	320	339	394	429	473	544	637	764	910	981	1047	1247
48 (122.0)	315	349	380	434	480	522	600	676	822	982	1081	1153	1373
54 (137.2)	324	360	406	458	507	555	643	729	901	1045	1118	1233	1457
60 (152.4)	346	382	429	489	544	600	691	787	949	1110	1186	1304	1542
66 (167.7)	361	406	451	522	570	630	742	846	1026	1176	1258	1385	1634
72 (182.9)	382	421	480	551	607	676	787	904	1058	1238	1333	1467	1723
84 (213.4)	419	458	524	607	683	748	885	1020	1179	1381	1515	1618	1889
96 (243.9)	458	505	569	666	743	825	978	1126	1300	1515	1661	1782	2091
108 (274.4)	494	577	612	706	800	893	1062	1228	1621	1652	1801	1950	2305
120 (304.8)	531	623	658	752	859	972	1147	1324	1637	1791	1945	2104	2516

Add Surcharge to Shade Price

Privacy Liner	\$83	94	110	122	132	150	176	217	244	267	303	337	400
Room-Darkening Liner	109	124	145	162	176	200	232	290	328	361	400	447	535
Valance Liner	17	20	26	28	32	35	41	50	55	59	69	77	92
Premiere Valance	40	43	48	50	55	61	77	84	93	107	119	137	159
Deco-Trim Valance or Deco-Trim Hem	82	84	89	91	93	97	101	105	113	118	124	127	135
Deco-Trim Pocket Hem, with Accent Rod	188	196	205	210	215	232	240	249	290	300	329	336	354
Deco-Trim Pocket Hem No Accent Rod	159	165	169	173	180	184	191	203	217	226	237	243	260

Due to material width sizes, shades to the right of the solid line must be manufactured as multiple shades on one headrail. Liners are 100% polyester. Liners available on all specialties except deco-trim valances. Due to weight limitations, shades with deco-pocket hems in the shaded area must be manufactured as multiple shades on one headrail at no charge.

Colors

Chencun		Escape		Serenity		Toushan II	
Appaloosa	00846	Forest	25601	Coastline	15702	Mocha	63759
White	60417	Island	25602	Dover White	15700	Taupe	63659
		Majian		Haze	11502		
		Driftwood	32445				
		Toffee	32296				

Price Charts

Price Group C: Inan, Moniz, Yunnan

Standard Roman and Old Style Roman

Height up to inches (cm) ↓	Width up to inches (cm) →												
	22 (55.9)	26 (66.1)	30 (76.2)	36 (91.5)	42 (106.7)	48 (122.0)	60 (152.4)	72 (182.9)	84 (213.4)	96 (243.9)	108 (274.4)	120 (304.8)	144 (365.8)
34 (86.4)	\$208	242	246	293	316	345	404	461	542	635	698	778	940
42 (106.7)	230	251	287	333	360	397	458	522	612	706	794	879	1053
48 (122.0)	266	293	321	366	403	436	501	568	671	785	879	971	1153
54 (137.2)	274	305	338	389	426	469	542	615	728	846	942	1036	1227
60 (152.4)	291	323	360	411	458	501	582	659	785	902	1000	1097	1297
66 (167.7)	308	338	379	436	482	535	626	712	834	957	1059	1164	1375
72 (182.9)	323	356	403	462	512	568	659	760	890	1012	1123	1234	1449
84 (213.4)	353	389	441	510	571	632	747	855	995	1128	1243	1362	1592
96 (243.9)	384	423	478	557	627	691	820	950	1096	1238	1368	1497	1761
108 (274.4)	417	456	516	596	673	753	892	1032	1256	1337	1485	1610	1940
120 (304.8)	450	487	553	633	725	815	964	1113	1268	1437	1605	1724	2118

Add Surcharge to Shade Price

	\$119						119			119			
Cordless Lift	69	84	101	113	124	141	167	209	238	261	293	329	392
Privacy Liner	96	110	133	152	164	186	219	279	314	348	391	435	521
Room-Darkening Liner	17	20	26	28	32	35	41	50	55	59	69	77	92
Valance Liner	40	43	48	50	55	61	77	84	93	107	119	137	159
Premiere Valance	82	84	89	91	93	97	101	105	113	118	124	127	135
Deco-Trim Valance or Deco-Trim Hem	188	196	205	210	215	232	240	249	290	300	329	336	354
Deco-Trim Pocket Hem, with Accent Rod	159	165	169	173	180	184	191	203	217	226	237	243	260
Deco-Trim Pocket Hem No Accent Rod													

Dotted line cordless lift, Inan and Yunnan. Solid line cordless lift, Moniz. Multiple cordless lift shades available up to 144" (365.8 cm). Liners available on all specialties except deco-trim valances. Cordless shades with liners have smaller size limits. Please contact customer service for the most up to date size considerations.

Due to material width sizes, shades to the right of the solid line must be manufactured as multiple shades on one headrail.

Looped Roman

Height up to inches (cm) ↓	Width up to inches (cm) →												
	22 (55.9)	26 (66.1)	30 (76.2)	36 (91.5)	42 (106.7)	48 (122.0)	60 (152.4)	72 (182.9)	84 (213.4)	96 (243.9)	108 (274.4)	120 (304.8)	144 (365.8)
34 (86.4)	\$272	314	320	380	410	448	525	599	705	825	906	1011	1223
42 (106.7)	298	326	374	433	467	516	596	677	797	919	1032	1143	1369
48 (122.0)	346	380	418	476	524	567	652	739	873	1021	1143	1263	1500
54 (137.2)	356	395	440	505	554	610	705	799	946	1099	1224	1346	1595
60 (152.4)	378	420	467	536	596	652	757	858	1021	1172	1299	1427	1687
66 (167.7)	400	440	494	567	626	694	814	924	1084	1243	1376	1513	1788
72 (182.9)	420	464	524	600	666	739	858	989	1157	1315	1460	1604	1885
84 (213.4)	460	505	572	662	743	822	972	1111	1294	1467	1617	1770	2070
96 (243.9)	500	551	622	725	815	900	1066	1237	1426	1608	1779	1945	2290
108 (274.4)	541	593	672	774	875	978	1161	1342	1633	1738	1930	2094	2522
120 (304.8)	585	633	718	823	942	1061	1254	1448	1648	1868	2087	2241	2754

Add Surcharge to Shade Price

Privacy Liner	\$83	94	110	122	132	150	176	217	244	267	303	337	400
Room-Darkening Liner	109	124	145	162	176	200	232	290	328	361	400	447	535
Valance Liner	17	20	26	28	32	35	41	50	55	59	69	77	92
Premiere Valance	40	43	48	50	55	61	77	84	93	107	119	137	159
Deco-Trim Valance or Deco-Trim Hem	82	84	89	91	93	97	101	105	113	118	124	127	135
Deco-Trim Pocket Hem, with Accent Rod	188	196	205	210	215	232	240	249	290	300	329	336	354
Deco-Trim Pocket Hem No Accent Rod	159	165	169	173	180	184	191	203	217	226	237	243	260

Due to material width sizes, shades to the right of the solid line must be manufactured as multiple shades on one headrail. Liners are 100% polyester. Liners available on all specialties except deco-trim valances. Due to weight limitations, shades with deco-pocket hems in the shaded area must be manufactured as multiple shades on one headrail at no charge.

Colors

Inan	Moniz	Yunnan
Umbra 04858	Austria 05083	Arctic Seal 19585
	Belgium 05084	Rocky Shore 19587
	Finland 05080	Sky 19586
	Peru 05081	

Price Charts

Price Group D: Amour, Boardwalk, Majuro

Standard Roman and Old Style Roman

Height up to inches (cm) ↓	Width up to inches (cm) →												
	22 (55.9)	26 (66.1)	30 (76.2)	36 (91.5)	42 (106.7)	48 (122.0)	60 (152.4)	72 (182.9)	84 (213.4)	96 (243.9)	108 (274.4)	120 (304.8)	144 (365.8)
34 (86.4)	\$250	275	299	343	366	384	469	547	666	783	838	889	999
42 (106.7)	272	304	328	375	399	430	522	608	736	863	926	985	1107
48 (122.0)	288	319	352	399	431	464	561	656	796	929	1000	1071	1209
54 (137.2)	307	340	375	430	464	501	603	709	856	997	1077	1158	1317
60 (152.4)	330	363	396	460	494	535	644	763	913	1060	1149	1234	1403
66 (167.7)	343	381	423	485	529	572	688	812	970	1131	1226	1317	1508
72 (182.9)	366	400	448	509	557	603	733	863	1028	1191	1295	1395	1602
84 (213.4)	399	445	490	565	618	679	817	962	1144	1332	1447	1563	1795
96 (243.9)	438	485	538	621	683	743	906	1060	1258	1465	1593	1725	1989
108 (274.4)	478	534	594	660	743	826	977	1172	1370	1602	1739	1886	2175
120 (304.8)	520	580	647	718	804	914	1067	1281	1482	1737	1891	2048	2358

Add Surcharge to Shade Price

	\$119						119			119			
Cordless Lift	69	84	101	113	124	141	167	209	238	261	293	329	392
Privacy Liner	96	110	133	152	164	186	219	279	314	348	391	435	521
Room-Darkening Liner	17	20	26	28	32	35	41	50	55	59	69	77	92
Valance Liner	40	43	48	50	55	61	77	84	93	107	119	137	159
Premiere Valance	82	84	89	91	93	97	101	105	113	118	124	127	135
Deco-Trim Valance or Deco-Trim Hem	188	196	205	210	215	232	240	249	290	300	329	336	354
Deco-Trim Pocket Hem, with Accent Rod	159	165	169	173	180	184	191	203	217	226	237	243	260
Deco-Trim Pocket Hem No Accent Rod													

Solid line cordless lift. Multiple cordless lift shades available up to 144" (365.8 cm). Liners available on all specialties except deco-trim valances. Cordless lift shades with liners have smaller size limits. Please contact customer service for the most up to date size considerations.

Due to material width sizes, shades to the right of the solid line must be manufactured as multiple shades on one headrail.

Looped Roman

Height up to inches (cm) ↓	Width up to inches (cm) →												
	22 (55.9)	26 (66.1)	30 (76.2)	36 (91.5)	42 (106.7)	48 (122.0)	60 (152.4)	72 (182.9)	84 (213.4)	96 (243.9)	108 (274.4)	120 (304.8)	144 (365.8)
34 (86.4)	\$326	357	387	446	476	500	610	710	866	1018	1089	1156	1300
42 (106.7)	353	395	427	487	519	560	679	791	957	1122	1203	1282	1439
48 (122.0)	375	415	459	519	561	605	729	853	1036	1208	1301	1392	1572
54 (137.2)	400	442	487	560	605	651	784	922	1113	1297	1401	1505	1713
60 (152.4)	429	472	516	597	642	696	837	992	1187	1378	1493	1604	1823
66 (167.7)	446	495	550	630	687	745	895	1056	1262	1471	1593	1713	1961
72 (182.9)	476	520	582	662	724	784	952	1122	1338	1548	1682	1814	2082
84 (213.4)	519	579	637	735	805	883	1063	1251	1487	1732	1881	2033	2335
96 (243.9)	569	630	700	807	887	966	1178	1378	1636	1905	2072	2243	2585
108 (274.4)	622	694	771	857	966	1074	1270	1523	1780	2082	2262	2452	2828
120 (304.8)	676	754	841	933	1044	1188	1387	1664	1926	2258	2458	2662	3066

Add Surcharge to Shade Price

Privacy Liner	\$83	94	110	122	132	150	176	217	244	267	303	337	400
Room-Darkening Liner	109	124	145	162	176	200	232	290	328	361	400	447	535
Valance Liner	17	20	26	28	32	35	41	50	55	59	69	77	92
Premiere Valance	40	43	48	50	55	61	77	84	93	107	119	137	159
Deco-Trim Valance or Deco-Trim Hem	82	84	89	91	93	97	101	105	113	118	124	127	135
Deco-Trim Pocket Hem, with Accent Rod	188	196	205	210	215	232	240	249	290	300	329	336	354
Deco-Trim Pocket Hem No Accent Rod	159	165	169	173	180	184	191	203	217	226	237	243	260

Due to material width sizes, shades to the right of the solid line must be manufactured as multiple shades on one headrail. Liners are 100% polyester. Liners available on all specialties except deco-trim valances. Due to weight limitations, shades with deco-pocket hems in the shaded area must be manufactured as multiple shades on one headrail at no charge.

Colors

Amour	Boardwalk	Majuro*
Pearl 00116	Pier 15968	Cattail 45071
Radiant 00001		Daisy 45070
		Stonybrook 45073
		Trail 45072

*Edge banding is required at no charge.

Price Charts

Price Group E: Beachfront, Meilin, Saterra, Terrestrial, Zishan

Standard Roman and Old Style Roman

Height up to inches (cm) ↓	Width up to inches (cm) →													
	22 (55.9)	26 (66.1)	30 (76.2)	36 (91.5)	42 (106.7)	48 (122.0)	60 (152.4)	72 (182.9)	84 (213.4)	96 (243.9)	108 (274.4)	120 (304.8)	144 (365.8)	
34 (86.4)	\$304	332	362	414	442	470	568	659	805	952	1013	1076	1203	
42 (106.7)	329	365	398	452	488	520	634	734	892	1048	1122	1197	1345	
48 (122.0)	352	387	429	488	521	564	681	800	960	1125	1211	1295	1464	
54 (137.2)	373	411	452	520	564	606	733	859	1036	1203	1302	1398	1593	
60 (152.4)	397	439	484	554	603	648	777	922	1101	1286	1390	1491	1702	
66 (167.7)	417	460	509	587	639	689	832	980	1173	1370	1483	1594	1824	
72 (182.9)	442	488	539	615	674	733	888	1044	1245	1442	1569	1691	1935	
84 (213.4)	487	536	593	682	752	817	990	1164	1385	1609	1751	1890	2170	
96 (243.9)	531	587	655	754	826	898	1095	1286	1526	1766	1926	2082	2399	
108 (274.4)	579	641	700	816	900	970	1202	1406	1668	1931	2104	2277	2620	
120 (304.8)	624	693	771	892	970	1048	1304	1528	1810	2096	2284	2471	2841	

Add Surcharge to Shade Price

	\$119						119				119		
Cordless Lift													
Privacy Liner	69	84	101	113	124	141	167	209	238	261	293	329	392
Room-Darkening Liner	96	110	133	152	164	186	219	279	314	348	391	435	521
Valance Liner	17	20	26	28	32	35	41	50	55	59	69	77	92
Premiere Valance	40	43	48	50	55	61	77	84	93	107	119	137	159
Deco-Trim Valance or Deco-Trim Hem	82	84	89	91	93	97	101	105	113	118	124	127	135
Deco-Trim Pocket Hem, with Accent Rod	188	196	205	210	215	232	240	249	290	300	329	336	354
Deco-Trim Pocket Hem No Accent Rod	159	165	169	173	180	184	191	203	217	226	237	243	260

Solid line cordless lift. Multiple cordless lift shades available up to 144" (365.8 cm). Liners available on all specialties except deco-trim valances. Cordless lift shades with liners have smaller size limits. Please contact customer service for the most up to date size considerations.

Due to material width sizes, shades to the right of the solid line must be manufactured as multiple shades on one headrail.

Looped Roman

Height up to inches (cm) ↓	Width up to inches (cm) →													
	22 (55.9)	26 (66.1)	30 (76.2)	36 (91.5)	42 (106.7)	48 (122.0)	60 (152.4)	72 (182.9)	84 (213.4)	96 (243.9)	108 (274.4)	120 (304.8)	144 (365.8)	
34 (86.4)	\$396	432	472	537	575	611	738	858	1046	1236	1318	1399	1564	
42 (106.7)	428	474	518	589	635	677	823	954	1159	1363	1458	1555	1749	
48 (122.0)	458	504	558	635	679	734	886	1040	1247	1462	1574	1683	1903	
54 (137.2)	485	535	589	677	734	788	953	1117	1348	1564	1693	1817	2070	
60 (152.4)	516	570	628	722	783	843	1010	1199	1431	1672	1807	1939	2212	
66 (167.7)	541	597	663	762	831	895	1081	1275	1525	1781	1927	2074	2372	
72 (182.9)	575	635	701	800	877	953	1154	1357	1618	1874	2038	2198	2516	
84 (213.4)	634	696	771	887	978	1063	1287	1514	1801	2093	2276	2456	2822	
96 (243.9)	690	762	850	979	1074	1168	1422	1672	1983	2296	2504	2707	3119	
108 (274.4)	752	834	910	1060	1169	1262	1563	1827	2168	2510	2735	2960	3407	
120 (304.8)	812	901	1003	1159	1262	1363	1694	1987	2352	2724	2969	3212	3695	

Add Surcharge to Shade Price

Privacy Liner	\$83	94	110	122	132	150	176	217	244	267	303	337	400
Room-Darkening Liner	109	124	145	162	176	200	232	290	328	361	400	447	535
Valance Liner	17	20	26	28	32	35	41	50	55	59	69	77	92
Premiere Valance	40	43	48	50	55	61	77	84	93	107	119	137	159
Deco-Trim Valance or Deco-Trim Hem	82	84	89	91	93	97	101	105	113	118	124	127	135
Deco-Trim Pocket Hem, with Accent Rod	188	196	205	210	215	232	240	249	290	300	329	336	354
Deco-Trim Pocket Hem No Accent Rod	159	165	169	173	180	184	191	203	217	226	237	243	260

Due to material width sizes, shades to the right of the solid line must be manufactured as multiple shades on one headrail. Liners are 100% polyester. Liners available on all specialties except deco-trim valances. Due to weight limitations, shades with deco-pocket hems in the shaded area must be manufactured as multiple shades on one headrail at no charge.

Colors

Beachfront	Meilin	Terrestrial	Zishan
Surf 60041	Chroma 51201	Alpaca 28001	Auburn 43689
Thatch 60042	Onyx 51227	Camel 28003	Feather 30735
Tidepool 60040	Saterra		Hula 30737
	Azure 03269		Hut 30736
	Terrain 03370		Stardust 43731
	Veridian 03371		Toast 43734

Price Charts

Price Group F: Azores, Madeira, Merino, Paralian

Standard Roman and Old Style Roman

Height up to inches (cm) ↓	Width up to inches (cm) →													
	22 (55.9)	26 (66.1)	30 (76.2)	36 (91.5)	42 (106.7)	48 (122.0)	60 (152.4)	72 (182.9)	84 (213.4)	96 (243.9)	108 (274.4)	120 (304.8)	144 (365.8)	
34 (86.4)	\$332	373	402	461	490	521	630	730	890	1051	1122	1198	1342	
42 (106.7)	369	406	440	500	541	577	701	811	990	1161	1244	1325	1489	
48 (122.0)	389	429	472	541	577	624	754	885	1067	1247	1344	1437	1628	
54 (137.2)	411	458	500	577	624	671	810	951	1146	1335	1444	1551	1769	
60 (152.4)	440	482	539	611	671	718	861	1022	1221	1426	1540	1657	1886	
66 (167.7)	463	512	566	652	710	761	923	1084	1300	1518	1643	1763	2011	
72 (182.9)	486	542	596	685	745	810	985	1161	1382	1599	1737	1873	2143	
84 (213.4)	541	595	658	757	833	906	1099	1294	1534	1785	1940	2096	2406	
96 (243.9)	592	652	727	836	916	993	1213	1426	1693	1959	2137	2310	2658	
108 (274.4)	646	710	785	897	991	1081	1317	1564	1853	2141	2336	2525	2906	
120 (304.8)	704	761	841	956	1072	1166	1426	1705	2010	2326	2536	2741	3159	

Add Surcharge to Shade Price

	\$119					119				119			
Cordless Lift	69	84	101	113	124	141	167	209	238	261	293	329	392
Privacy Liner	96	110	133	152	164	186	219	279	314	348	391	435	521
Room-Darkening Liner	17	20	26	28	32	35	41	50	55	59	69	77	92
Valance Liner	40	43	48	50	55	61	77	84	93	107	119	137	159
Premiere Valance	82	84	89	91	93	97	101	105	113	118	124	127	135
Deco-Trim Valance or Deco-Trim Hem	188	196	205	210	215	232	240	249	290	300	329	336	354
Deco-Trim Pocket Hem, with Accent Rod	159	165	169	173	180	184	191	203	217	226	237	243	260
Deco-Trim Pocket Hem No Accent Rod													

Solid line cordless lift. Multiple cordless lift shades available up to 144" (365.8 cm). Liners available on all specialties except deco-trim valances. Cordless lift shades with liners have smaller size limits. Please contact customer service for the most up to date size considerations.

Due to material width sizes, shades to the right of the solid line must be manufactured as multiple shades on one headrail.

Looped Roman

Height up to inches (cm) ↓	Width up to inches (cm) →													
	22 (55.9)	26 (66.1)	30 (76.2)	36 (91.5)	42 (106.7)	48 (122.0)	60 (152.4)	72 (182.9)	84 (213.4)	96 (243.9)	108 (274.4)	120 (304.8)	144 (365.8)	
34 (86.4)	\$431	484	522	599	637	676	819	949	1157	1366	1459	1557	1745	
42 (106.7)	481	527	571	651	703	748	910	1054	1287	1510	1618	1723	1936	
48 (122.0)	505	557	615	703	748	812	980	1149	1388	1621	1747	1868	2116	
54 (137.2)	536	596	651	748	812	873	1052	1238	1489	1734	1877	2016	2300	
60 (152.4)	571	626	701	794	873	934	1119	1328	1588	1853	2001	2154	2452	
66 (167.7)	602	666	735	848	921	990	1201	1410	1691	1974	2134	2291	2614	
72 (182.9)	632	705	774	890	969	1052	1280	1510	1797	2079	2258	2435	2785	
84 (213.4)	703	773	855	985	1082	1178	1430	1682	1995	2321	2522	2725	3129	
96 (243.9)	769	848	945	1088	1191	1290	1577	1853	2202	2548	2779	3003	3456	
108 (274.4)	840	921	1021	1166	1288	1405	1712	2033	2409	2783	3037	3283	3779	
120 (304.8)	916	990	1093	1242	1394	1516	1853	2217	2613	3023	3296	3563	4106	

Add Surcharge to Shade Price

Privacy Liner	\$83	94	110	122	132	150	176	217	244	267	303	337	400
Room-Darkening Liner	109	124	145	162	176	200	232	290	328	361	400	447	535
Valance Liner	17	20	26	28	32	35	41	50	55	59	69	77	92
Premiere Valance	40	43	48	50	55	61	77	84	93	107	119	137	159
Deco-Trim Valance or Deco-Trim Hem	82	84	89	91	93	97	101	105	113	118	124	127	135
Deco-Trim Pocket Hem, with Accent Rod	188	196	205	210	215	232	240	249	290	300	329	336	354
Deco-Trim Pocket Hem No Accent Rod	159	165	169	173	180	184	191	203	217	226	237	243	260

Due to material width sizes, shades to the right of the solid line must be manufactured as multiple shades on one headrail. Liners are 100% polyester. Liners available on all specialties except deco-trim valances. Due to weight limitations, shades with deco-pocket hems in the shaded area must be manufactured as multiple shades on one headrail at no charge.

Colors

Azores	Madeira	Merino	Paralian*
Carob 35063	Brunette 65010	Belize 55508	Mink 25050
Snow 35060	Wolf 65011	Burgos 50503	Otter 25052
Suede 35061		Grenada 55507	Sand Dollar 25051
Sycamore 35062		Sevilla 55506	

*Edge banding is required at no charge.

Price Charts

Price Group G: Lipo, Revelry

Standard Drapery Fullness

Height up to inches (cm) ↓	Width up to inches (cm) →													
	48 (122.0)	60 (152.4)	72 (182.9)	78 (198.2)	84 (213.4)	96 (243.9)	108 (274.4)	120 (304.8)	132 (335.3)	144 (365.8)	156 (396.3)	168 (426.8)	180 (457.2)	192 (487.7)
36 (91.5)	\$426	500	557	609	702	715	779	971	1035	1080	1136	1199	1281	1293
48 (122.0)	468	556	626	684	791	804	887	1083	1164	1223	1279	1352	1454	1464
60 (152.4)	524	611	696	759	880	893	991	1201	1293	1362	1416	1504	1629	1639
72 (182.9)	551	671	759	837	966	982	1098	1315	1426	1499	1557	1660	1799	1811
84 (213.4)	595	725	831	923	1056	1066	1201	1402	1555	1637	1701	1811	1973	1986
96 (243.9)	632	779	900	991	1140	1155	1272	1550	1685	1780	1842	1967	2148	2157
Privacy Liner	194	198	209	209	209	215	220	227	229	231	238	242	251	255
Room-Darkening Liner	251	255	271	271	271	277	283	288	295	306	309	317	323	331

NOTE: Price includes premiere valance. Must provide desired valance options.

60% Drapery Fullness

Height up to inches (cm) ↓	Width up to inches (cm) →													
	48 (122.0)	60 (152.4)	72 (182.9)	78 (198.2)	84 (213.4)	96 (243.9)	108 (274.4)	120 (304.8)	132 (335.3)	144 (365.8)	156 (396.3)	168 (426.8)	180 (457.2)	192 (487.7)
36 (91.5)	\$650	764	850	930	1072	1091	1189	1482	1579	1648	1733	1831	1955	1972
48 (122.0)	714	849	956	1043	1207	1226	1353	1653	1777	1865	1950	2064	2217	2236
60 (152.4)	799	933	1061	1158	1344	1364	1513	1834	1972	2079	2161	2297	2484	2503
72 (182.9)	840	1023	1158	1279	1474	1499	1676	2008	2175	2287	2376	2533	2746	2765
84 (213.4)	907	1106	1268	1410	1614	1628	1834	2139	2373	2499	2595	2765	3012	3032
96 (243.9)	964	1189	1373	1513	1740	1763	1942	2365	2570	2716	2812	3001	3279	3292
Privacy Liner	309	317	334	334	334	343	354	363	367	371	380	389	398	406
Room-Darkening Liner	398	406	436	436	436	444	451	460	480	488	495	505	518	530

NOTE: Price includes premiere valance. Must provide desired valance options.

Colors

Lipo

Ambrosia 06702
 Earthtones 06793
 Java 06703
 Tahoe 06705

Revelry

Birdnest 80045
 Dove 80745
 Dusk 80743

Price Charts

Price Group H: Chencun, Escape, Majian, Serenity, Toushan II

Standard Drapery Fullness

Height up to inches (cm) ↓	Width up to inches (cm) →													
	48 (122.0)	60 (152.4)	72 (182.9)	78 (198.2)	84 (213.4)	96 (243.9)	108 (274.4)	120 (304.8)	132 (335.3)	144 (365.8)	156 (396.3)	168 (426.8)	180 (457.2)	192 (487.7)
36 (91.5)	\$472	554	618	650	748	762	811	1009	1076	1122	1180	1244	1331	1341
48 (122.0)	516	617	693	729	842	856	921	1126	1211	1270	1328	1404	1510	1523
60 (152.4)	581	677	770	811	939	953	1031	1248	1341	1416	1473	1564	1691	1705
72 (182.9)	610	741	842	893	1031	1047	1104	1326	1482	1560	1619	1724	1868	1882
84 (213.4)	657	801	920	964	1126	1136	1210	1420	1616	1702	1768	1882	2050	2065
96 (243.9)	702	862	995	1061	1219	1233	1331	1560	1751	1848	1915	2043	2232	2242
Privacy Liner	194	198	209	209	209	215	220	227	229	231	238	242	251	255
Room-Darkening Liner	251	255	271	271	271	277	283	288	295	306	309	317	323	331

NOTE: Price includes premiere valance. Must provide desired valance options.

60% Drapery Fullness

Height up to inches (cm) ↓	Width up to inches (cm) →													
	48 (122.0)	60 (152.4)	72 (182.9)	78 (198.2)	84 (213.4)	96 (243.9)	108 (274.4)	120 (304.8)	132 (335.3)	144 (365.8)	156 (396.3)	168 (426.8)	180 (457.2)	192 (487.7)
36 (91.5)	\$720	846	944	991	1143	1164	1238	1540	1642	1712	1801	1899	2030	2047
48 (122.0)	788	942	1056	1112	1285	1307	1406	1719	1848	1939	2027	2143	2304	2324
60 (152.4)	887	1035	1175	1238	1432	1455	1574	1905	2047	2161	2247	2387	2581	2602
72 (182.9)	931	1131	1285	1364	1574	1597	1685	2024	2260	2379	2470	2630	2852	2873
84 (213.4)	1002	1223	1404	1472	1719	1733	1846	2169	2466	2596	2698	2873	3127	3150
96 (243.9)	1072	1315	1518	1618	1861	1881	2030	2379	2672	2819	2922	3119	3407	3421
Privacy Liner	309	317	334	334	334	343	354	363	367	371	380	389	398	406
Room-Darkening Liner	398	406	436	436	436	444	451	460	480	488	495	505	518	530

NOTE: Price includes premiere valance. Must provide desired valance options.

Colors

Chencun	Majian	Serenity	Toushan II
Appaloosa 00846	Driftwood 32445	Coastline 15702	Mocha 63759
White 60417	Toffee 32296	Dover White 15700	Taupe 63659
Escape		Haze 11502	
Forest 25601			
Island 25602			

Price Charts

Price Group I: Inan, Moniz, Yunnan

Standard Drapery Fullness

Height up to inches (cm) ↓	Width up to inches (cm) →													
	48 (122.0)	60 (152.4)	72 (182.9)	78 (198.2)	84 (213.4)	96 (243.9)	108 (274.4)	120 (304.8)	132 (335.3)	144 (365.8)	156 (396.3)	168 (426.8)	180 (457.2)	192 (487.7)
36 (91.5)	\$508	598	665	698	806	822	897	1115	1189	1241	1307	1377	1472	1486
48 (122.0)	557	664	748	786	907	923	1020	1248	1340	1403	1470	1555	1672	1687
60 (152.4)	624	731	828	874	1010	1026	1140	1381	1486	1565	1628	1729	1871	1885
72 (182.9)	657	798	907	962	1111	1126	1260	1514	1639	1722	1791	1907	1988	2083
84 (213.4)	710	865	991	1062	1214	1226	1381	1647	1750	1882	1955	2083	2270	2283
96 (243.9)	755	931	1070	1140	1313	1328	1504	1780	1936	2044	2118	2262	2469	2480
Privacy Liner	194	198	209	209	209	215	220	227	229	231	238	242	251	255
Room-Darkening Liner	251	255	271	271	271	277	283	288	295	306	309	317	323	331

NOTE: Price includes premiere valance. Must provide desired valance options.

60% Drapery Fullness

Height up to inches (cm) ↓	Width up to inches (cm) →													
	48 (122.0)	60 (152.4)	72 (182.9)	78 (198.2)	84 (213.4)	96 (243.9)	108 (274.4)	120 (304.8)	132 (335.3)	144 (365.8)	156 (396.3)	168 (426.8)	180 (457.2)	192 (487.7)
36 (91.5)	\$774	914	1015	1065	1229	1255	1368	1702	1813	1894	1994	2102	2246	2268
48 (122.0)	850	1012	1143	1200	1385	1410	1556	1905	2044	2142	2243	2373	2551	2575
60 (152.4)	951	1117	1264	1333	1542	1566	1740	2108	2268	2389	2483	2638	2856	2876
72 (182.9)	1002	1218	1385	1469	1696	1719	1925	2310	2503	2627	2731	2911	3035	3178
84 (213.4)	1082	1321	1513	1620	1853	1871	2108	2513	2670	2873	2984	3178	3465	3483
96 (243.9)	1151	1420	1634	1740	2003	2027	2297	2716	2955	3120	3232	3452	3768	3784
Privacy Liner	309	317	334	334	334	343	354	363	367	371	380	389	398	406
Room-Darkening Liner	398	406	436	436	436	444	451	460	480	488	495	505	518	530

NOTE: Price includes premiere valance. Must provide desired valance options.

Colors

Inan	Moniz	Yunnan
Umber 04858	Austria 05083	Arctic Seal 19585
	Belgium 05084	Rocky Shore 19587
	Finland 05080	Sky 19586
	Peru 05081	

Price Charts

Price Group J: Amour, Boardwalk, Majuro

Standard Drapery Fullness

Height up to inches (cm) ↓	Width up to inches (cm) →													
	48 (122.0)	60 (152.4)	72 (182.9)	78 (198.2)	84 (213.4)	96 (243.9)	108 (274.4)	120 (304.8)	132 (335.3)	144 (365.8)	156 (396.3)	168 (426.8)	180 (457.2)	192 (487.7)
36 (91.5)	\$507	601	663	712	823	837	913	1137	1212	1266	1330	1404	1500	1514
48 (122.0)	557	666	745	800	924	941	1039	1270	1364	1431	1497	1584	1703	1717
60 (152.4)	624	739	834	890	1030	1046	1162	1407	1514	1594	1659	1763	1907	1922
72 (182.9)	663	799	906	981	1131	1149	1286	1542	1670	1754	1823	1944	2108	2123
84 (213.4)	718	860	989	1082	1238	1248	1407	1673	1820	1917	1994	2123	2311	2326
96 (243.9)	760	929	1066	1162	1338	1355	1589	1815	1973	2083	2158	2305	2517	2526
Privacy Liner	194	198	209	209	209	215	220	227	229	231	238	242	251	255
Room-Darkening Liner	251	255	271	271	271	277	283	288	295	306	309	317	323	331

NOTE: Price includes premiere valance. Must provide desired valance options.

60% Drapery Fullness

Height up to inches (cm) ↓	Width up to inches (cm) →													
	48 (122.0)	60 (152.4)	72 (182.9)	78 (198.2)	84 (213.4)	96 (243.9)	108 (274.4)	120 (304.8)	132 (335.3)	144 (365.8)	156 (396.3)	168 (426.8)	180 (457.2)	192 (487.7)
36 (91.5)	\$775	918	1012	1086	1256	1277	1393	1736	1850	1931	2029	2142	2289	2310
48 (122.0)	851	1015	1136	1223	1411	1435	1586	1938	2082	2183	2283	2416	2599	2620
60 (152.4)	952	1129	1271	1358	1573	1599	1774	2149	2310	2433	2531	2691	2909	2933
72 (182.9)	1012	1220	1382	1498	1727	1753	1962	2353	2548	2676	2783	2966	3216	3239
84 (213.4)	1096	1312	1509	1650	1889	1905	2149	2554	2777	2926	3044	3239	3527	3550
96 (243.9)	1159	1418	1626	1774	2040	2066	2425	2769	3010	3179	3295	3516	3841	3855
Privacy Liner	309	317	334	334	334	343	354	363	367	371	380	389	398	406
Room-Darkening Liner	398	406	436	436	436	444	451	460	480	488	495	505	518	530

NOTE: Price includes premiere valance. Must provide desired valance options.

Colors

Amour	Boardwalk	Majuro*
Pearl 00116	Pier 15968	Cattail 45071
Radiant 00001		Daisy 45070
		Stonybrook 45073
		Trail 45072

*Edge banding is required at no charge.

Price Charts

Price Group K: Azores, Madeira, Merino, Paralian

Standard Drapery Fullness

Height up to inches (cm) ↓	Width up to inches (cm) →													
	48 (122.0)	60 (152.4)	72 (182.9)	78 (198.2)	84 (213.4)	96 (243.9)	108 (274.4)	120 (304.8)	132 (335.3)	144 (365.8)	156 (396.3)	168 (426.8)	180 (457.2)	192 (487.7)
36 (91.5)	\$572	674	754	834	962	981	1068	1332	1419	1482	1556	1643	1754	1772
48 (122.0)	630	750	843	936	1082	1103	1215	1487	1598	1674	1752	1853	1992	2011
60 (152.4)	647	825	935	1043	1206	1225	1360	1649	1772	1866	1943	2065	2232	2247
72 (182.9)	741	904	1024	1146	1324	1344	1504	1805	1953	2053	2135	2274	2467	2484
84 (213.4)	799	976	1119	1269	1447	1462	1649	1953	2132	2244	2332	2484	2703	2723
96 (243.9)	852	1050	1210	1360	1566	1584	1878	2123	2308	2438	2526	2695	2944	2957
Privacy Liner	194	198	209	209	209	215	220	227	229	231	238	242	251	255
Room-Darkening Liner	251	255	271	271	271	277	283	288	295	306	309	317	323	331

NOTE: Price includes premiere valance. Must provide desired valance options.

60% Drapery Fullness

Height up to inches (cm) ↓	Width up to inches (cm) →													
	48 (122.0)	60 (152.4)	72 (182.9)	78 (198.2)	84 (213.4)	96 (243.9)	108 (274.4)	120 (304.8)	132 (335.3)	144 (365.8)	156 (396.3)	168 (426.8)	180 (457.2)	192 (487.7)
36 (91.5)	\$874	1029	1150	1272	1469	1497	1631	2033	2166	2260	2375	2507	2677	2703
48 (122.0)	961	1144	1286	1429	1651	1682	1854	2270	2439	2554	2673	2829	3038	3068
60 (152.4)	988	1258	1428	1591	1840	1868	2075	2517	2703	2848	2965	3150	3407	3430
72 (182.9)	1131	1380	1563	1749	2021	2051	2297	2754	2980	3133	3259	3471	3764	3791
84 (213.4)	1219	1489	1706	1936	2210	2232	2517	2980	3254	3425	3558	3791	4126	4155
96 (243.9)	1301	1602	1846	2075	2390	2417	2866	3239	3523	3720	3855	4112	4493	4511
Privacy Liner	309	317	334	334	334	343	354	363	367	371	380	389	398	406
Room-Darkening Liner	398	406	436	436	436	444	451	460	480	488	495	505	518	530

NOTE: Price includes premiere valance. Must provide desired valance options.

Colors

Azores	Madeira	Merino	Paralian*
Carob 35063	Brunette 65010	Belize 55508	Mink 25050
Snow 35060	Wolf 65011	Burgos 50503	Otter 25052
Suede 35061		Grenada 55507	Sand Dollar 25051
Sycamore 35062		Sevilla 55506	

*Edge banding is required at no charge.

Options Pricing

Options Pricing

Natural Shade Options

Surcharge

Angled Top	Price as standard shade using angled width and longest height; add \$226
Bay or Corner Window	No charge
Bottom Up/Top Down	\$99
Continuous-Loop Lift	\$99 per panel
Cord Cleats	Antique brass: \$5 Solid brass: \$10
Cord Winder	\$8
Cut-Outs	\$67
Edge Banding	Standard: \$135; looped: \$170; old style: \$135; valance only: \$55
Hem Options: Standard Hem	No charge
Hem Options: Deco-Trim	See price charts
Hem Options: Deco-Pocket	See price charts
Hold Down Brackets (extend from side of hem and must be requested at the time of the order)	No charge
Liners: Privacy and Room Darkening	See price charts
Motorized Lift: Standard and Old Style Roman Shades	See motorization price list
Multiple Shades on One Headrail	Two-on-one headrail (to left of bold line on price chart): \$99 Three-on-one headrail (to left of bold line on price chart): \$99
Projection Brackets: 2" (5.1 cm), 2 ⁵ / ₈ " (6.7 cm), 3 ¹ / ₂ " (8.9 cm)	No charge
Returns: 2" (5.1 cm) for Shades	No charge (not available on turned headrail)
Side Mount Bracket	No charge
Turned Headrail	No charge
Valances: 6" (15.3 cm)	No charge
Valances: 9" (22.9 cm)	\$14; no charge for continuous-loop lift or motorized lift
Valances: Premiere	See price charts
Valances: Deco-Trim	See price charts
Wood Cornices and Valances	See cornices and valances price list

Natural Drape Options

Surcharge

Ceiling Brackets	No charge
Drape Fullness: Standard or 60%	See price charts
Edge Banding for Top, Bottom, and Valance	No charge
Edge Banding for Drape Side Optional	No charge
No Valance: Optional	No charge
Privacy or Room-Darkening Liner for Drape (option at time of order)	See price charts
Premiere Valance (included at the time of order)	No charge at time of order; premiere valance only, see price chart below
Wood Cornices and Valances	See cornices and valances price list

Premiere Valance Only

Width up to inches (cm)	18 (45.8)	24 (61.0)	28 (71.2)	32 (81.3)	36 (91.5)	42 (106.7)	48 (122.0)	54 (137.2)	60 (152.4)	66 (167.7)	72 (182.9)	78 (198.2)	84 (213.4)	90 (228.6)	96 (243.9)	108 (274.4)	120 (304.8)	144 (365.8)	156 (396.3)	168 (426.8)	180 (457.2)	192 (487.7)
Premiere Valance	\$97	108	120	138	147	167	186	205	223	242	259	279	298	317	335	373	411	448	486	524	562	600
Liner on Valance (Privacy or Room Darkening)	14	17	20	26	28	32	35	39	41	46	50	52	55	57	59	69	77	92	110	129	146	165

NOTE: The valance material comes attached to a hardwood frame and includes mounting brackets (standard, ceiling, or projection brackets).

GRABER®

Grabber is a brand of Springs Window Fashions, the Best Experience Company 

Grabber and the Grabber logo are registered trademarks of Springs Window Fashions, LLC.

19-0358-05 (02/19) 18-10490|S18-9734