

**NORMAN**<sup>®</sup>  
SHUTTERS. BLINDS. SHADES.



# Citylights<sup>™</sup> Aluminum Blinds

March 2021

# Revision Log

Date	Revision
7/22/2019	Pg. 7: Added control location option Pg. 8: Added min custom cord drop
2/24/2021	<a href="#">Pg. 7:</a> Added custom min blind length note <a href="#">Pg. 8:</a> Updated custom cord drop; revised notes <a href="#">Pg. 9:</a> Added color codes <a href="#">Pg. 11:</a> Updated hardware info
3/30/2021	<a href="#">Pg. 7:</a> Added custom min blind length note <a href="#">Pg. 8:</a> Updated custom cord drop

# Table of Contents

	Page
Features and Benefits	4
Terminology	5 – 6
General Specifications	7 – 9
Color Availability	9
Mounting Depths	10
Parts and Hardware	11

## Features and Benefits

- Slats are treated with Advanced Finished Technology, providing a smooth, rigid, less porous surface. AFT delivers anti-static performance to repel dust and antimicrobial qualities to resist fungal and bacterial growth.
- Curved, valance-free decorative steel headrail and premium steel bottom rail
- Standard Wand Tilt
- Aesthetically pleasing modern tassels
- Hidden brackets for a streamlined appearance
- Innovative Insta-Lock™ mechanism locks the blind at any position effortlessly
- Optional privacy slats for enhanced light control

# Terminology

## Steel Head Rail System – Wand Tilter (Default)

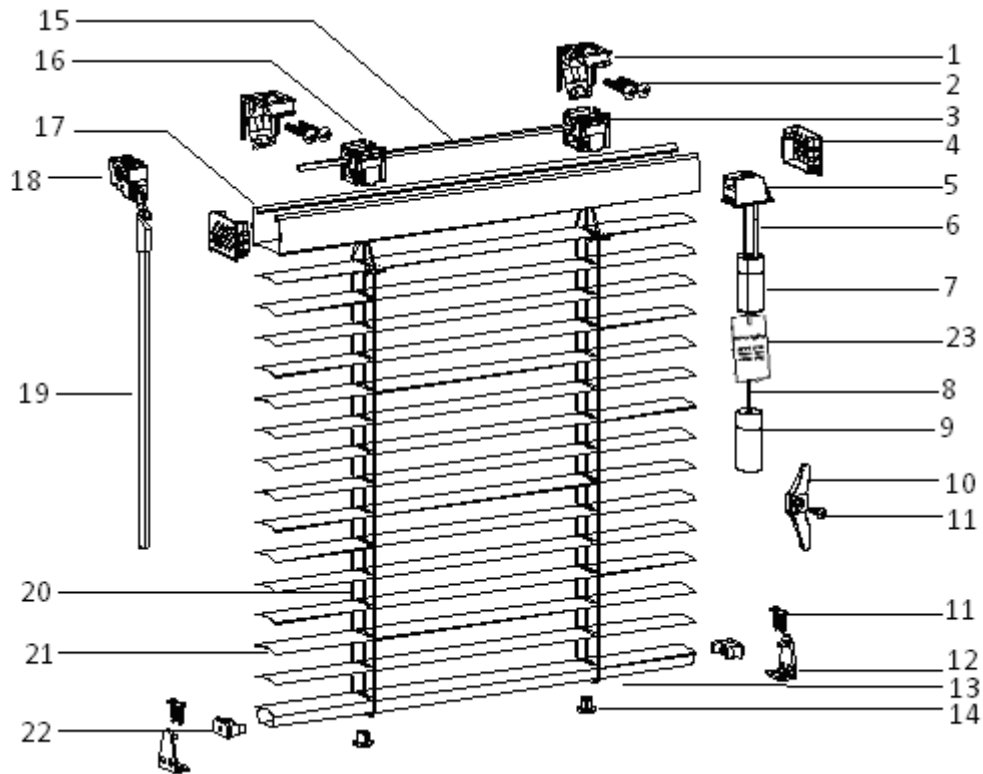

Description					
1	Installation Bracket	9	Tassel	17	Head rail
2	Screw for Installation Bracket	10	Cord Cleat	18	Wand Tilter
3	Drum Support	11	Screw for hold down bracket and cord cleat	19	Wand
4	Head rail End Cap	12	Hold Down Bracket	20	Ladder Cord
5	Insta-Lock	13	Bottom Rail	21	Slat
6	Pull Cord	14	Bottom Rail Button	22	Bottom Rail End Cap
7	Cord Release Device	15	Tilt Rod	23	Warning Tag
8	Tassel Cord	16	Drum		

# Terminology

## Steel Head Rail System - Cord Tilter (Optional)

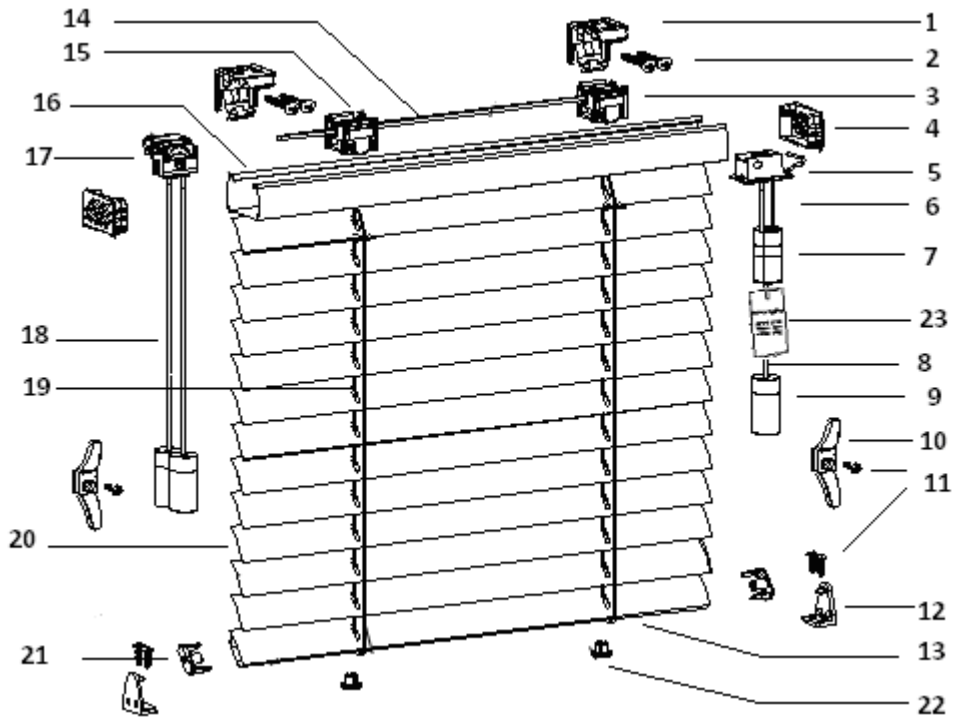

Description					
1	Installation Bracket	9	Tassel	17	Cord Tilter
2	Screw for Installation Bracket	10	Cord Cleat	18	Tilter Cord
3	Drum Support	11	Screw for hold down bracket and cord cleat	19	Ladder Cord
4	Head rail End Cap	12	Hold Down Bracket	20	Slat
5	Insta-Lock	13	Bottom Rail	21	Bottom Rail End Cap
6	Pull Cord	14	Tilt Rod	22	Bottom Rail Button
7	Cord Release Device	15	Drum	23	Warning Tag
8	Tassel Cord	16	Head rail		

# Size Considerations

	Wand Tilt			Cord Tilt		
	Min	Max	Max Area	Min	Max	Max Area
Width	9"	96"	60 SQFT	9"	96"	60 SQFT
Length	25 1/2" *	126"		38" **	126"	

\* Min custom blind length is  $10" \leq Y < 25 \frac{1}{2}"$  when a custom cord is specified.

\*\* Min custom blind length is  $10" \leq Y < 38"$  when a custom cord is specified.

- Blinds less than 12" widths only have a center tilt without lift cords.
- Please consider the max area; max width & max length cannot be ordered as one blind.
- 2 on 1 is not available.
- Cut-out is not available.

# Standard Deductions

- Inside Mount: Order Width-3/8" = Finished Blind Width
- Outside Mount: Order Width = Finished Blind Width
- Tolerance: Width =  $\pm 1/16"$ , Length =  $0 \sim 1/4"$  when slats are in level opening position.

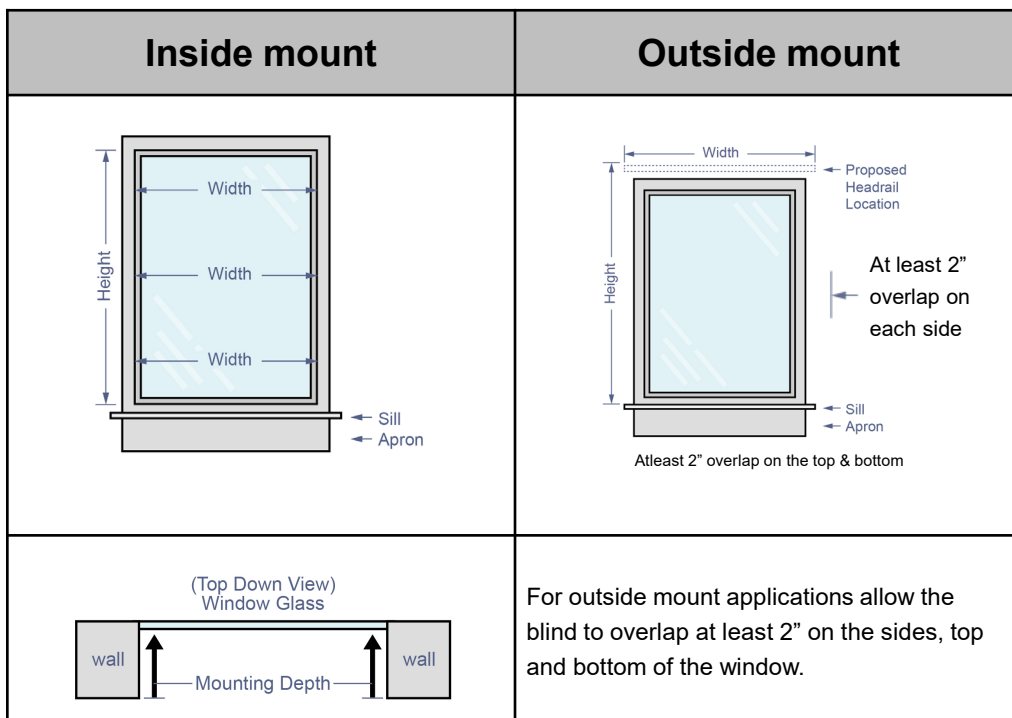

# Control Location

- Standard (Wand Left, Lift Cord Right)
- Optional:
  - Reverse (Wand Right, Lift Cord Left)
  - Group Left (Wand & Lift Cord Left)
  - Group Right (Wand & Lift Cord Right)
- \*Min 15 1/8" width for Group Left & Group Right
- \*Optional Control Location is not available for smaller blinds (**Blind Width < 12"**)

	Size	Wand Tilt	Cord Tilt
Standard (Small)*	9" ≤ Blind Width < 12"	Wand Tilter only	Center Tilter only
Standard	Blind Width ≥ 12"	Wand left, lift right	Tilt cord left, lift cord right
Optional	Blind Width ≥ 12"	Wand right, lift left	Tilt cord right, lift cord left
	Blind Width ≥ 15 1/8"	Wand left, lift left; Wand right, lift right	Tilt cord left, lift cord left; Tilt cord right, lift cord right

# Wand & Cord Drop Standards

## Wand Tilt

- There are 7 standard wand drop sizes available, based on the blind's height. See chart below.
- These sizes are also available as a selectable option.
- **Minimum custom cord drop: 10"**
- The wand may be split into **2~4 pieces**

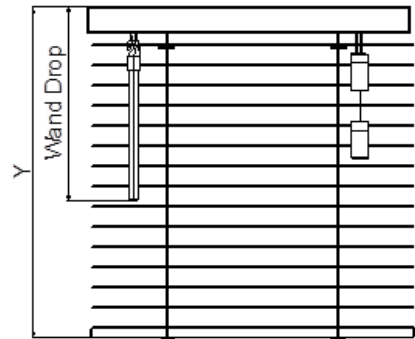

Blind Width (X) (for split wand)	Blind Height (Y)	Wand Drop *	Wand Drop Tolerance	Tassel Cord Drop	Tassel Cord Tolerance
9" ≤ X ≤ 15"	Y ≤ 36"	17"	0", -1"	< 2/5Y	0", -1/2"
9" ≤ X ≤ 19"	36" < Y ≤ 48"	21"			
9" ≤ X ≤ 22"	48" < Y ≤ 60"	24"			
9" ≤ X ≤ 28"	60" < Y ≤ 72"	30"			
9" ≤ X ≤ 34"	72" < Y ≤ 84"	36"			
9" ≤ X ≤ 46"	84" < Y ≤ 96"	48"			
9" ≤ X ≤ 58"	96" < Y ≤ 126"	60"			

## Cord Tilt

Blind Drop (Y)	Drop of Tilt Cord	Drop of Tassel Cord	Tolerance
38" ≤ Y ≤ 126"	< 2/5Y	< 2/5Y	(0", -1/2")

Minimum custom cord drop: **15"**

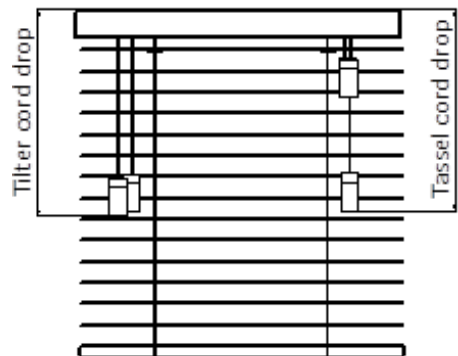



# Slat Options

Slat Options	1" Slats - 6 Gauge	1" Slats - 8 Gauge	1/2" Micro Slats -8 Gauge
Perforated	×	√	√
Metallic/Pearlized	√	√	√

- 6 gauge slat thickness=0.16mm
- 8 gauge slat thickness=0.21mm

# Color Availability



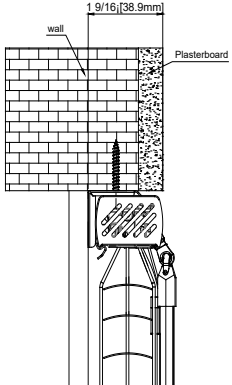
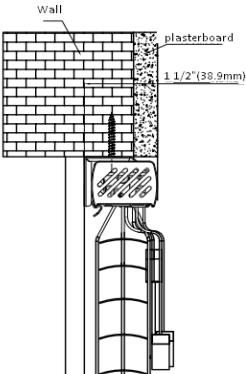
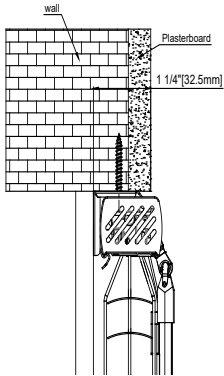
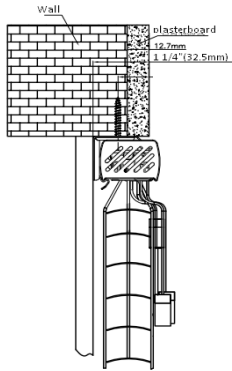

No.	Color Code	Color Name
1	7001	Oxford White
2	7003	White
3	7006	Alabaster
4	7019	Soft Shell
5	7020	Ivory
6	7021	Antique Lace
7	7022	Beige
8	7023	Vanilla
9	7024	Pure White
10	7026	Bright White
11	7027	Pure White Perforated**
12	7102	Brushed Aluminum*
13	7103	Silver Moon*
14	7105	Platinum*
15	7109	Metallic Bronze*
16	7111	Silver Perforated**
17	7201	Black
18	7203	Dark Earth
19	7204	Tarmac
20	7302	Red
21	7309	Strawberry Cream
22	7402	Bronze*
23	7508	Lemondrop
24	7507	Bisque
25	7509	Peach Sorbet
26	7510	Harvest Gold
27	7511	Sugar Maple
28	7604	Deep Ivy
29	7712	Royal Blue*
30	7713	Sky

\*10% Surcharge  
 \*\*30% Surcharge

# Mounting Depth

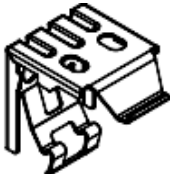
Mounting Type	System	Mounting Depth Requirement	Drawing
Fully IB	Wand Tilt	1 9/16"	
	Cord Tilt	1 1/2"	
Semi-IB	Wand Tilt	1 1/4"	
	Cord Tilt	1 1/4"	

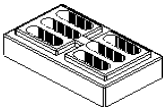
# Parts and Hardware

Item	Drawings
Installation Bracket	
Head Rail Mechanism: Wand Tilter	
Head Rail Mechanism: Cord Tilter	
Shim (Optional)	
Hold Down Bracket  (Optional; Provided by default if 1" or 1/2" Micro slats with SafeNotch blind width is less than 18")	
Cord cleat	

# Hardware

Blind Width	Bracket	Cord Cleat	3/4" Screw for Cord Cleat	Hold Down Bracket (Option)	3/4" Screw for hold down bracket (Option)	#6x1" Screw for bracket
X < 12"	2	None (wand tilt) 1 pc (cord tilt)	None (wand tilt) 1 pc (cord tilt)			4
12" ≤ X ≤ 47"	2	1 pc (wand tilt) 2 pcs (cord tilt)	1 pc (wand tilt) 2 pcs (cord tilt)	2	4	4
47" < X ≤ 80"	3		6			
80" < X ≤ 96"	4		8			